

# Coiltronics DR Series

## High power density, high efficiency, shielded inductors



### Product description

- Lead free, RoHS compliant
- 125°C maximum total operating temperature
- Four sizes of shielded drum core inductors
- Inductance range from 0.33µH to 1000µH
- Current range up to 56 amps peak
- Magnetic shielding
- Secure mounting
- Ferrite core material

### Applications

- Computer, DVD players, and portable power devices
- LCD panels
- DC-DC converters
- Buck, boost, forward, and resonant converters
- Noise filtering and filter chokes

### Environmental data

- Storage temperature range (Component): -40°C to +125°C
- Operating temperature range: -40°C to +125°C (ambient + self-temperature rise)
- Solder reflow temperature: J-STD-020D compliant

### Packaging:

- Supplied in tape and reel packaging (per reel):
  - DR73 1350
  - DR74 1100
  - DR125 600
  - DR127 350



Powering Business Worldwide



The Coiltronics brand of magnetics (formerly of the Bussmann Division of Cooper Industries) is now part of Eaton's Electrical Group, Electronics Division.

**Coiltronics is now part of Eaton**  
**Same great products plus even more.**

**Product specifications**

Part Number	Rated Inductance (μH)	OCL <sup>1</sup> ±20% (μH)	$I_{rms}^2$ Amps	$I_{sat}^3$ Amps Peak	DCR <sup>4</sup> (Ω) Typ.	Volt-μSec <sup>5</sup> Typ.
DR73-R33-R	0.33	0.306	6.21	14.4	0.0073	1.98
DR73-1R0-R	1.00	0.992	5.28	7.97	0.0102	3.56
DR73-1R5-R	1.50	1.482	4.67	6.52	0.0130	4.36
DR73-2R2-R	2.20	2.070	4.15	5.52	0.0165	5.15
DR73-3R3-R	3.30	3.540	3.31	4.22	0.0259	6.73
DR73-4R7-R	4.70	4.422	3.09	3.78	0.0297	7.52
DR73-6R8-R	6.80	6.480	2.55	3.12	0.0435	9.11
DR73-8R2-R	8.20	8.930	2.19	2.66	0.0592	10.7
DR73-100-R	10.0	10.30	2.08	2.47	0.0656	11.5
DR73-150-R	15.0	15.01	1.83	2.05	0.0844	13.9
DR73-220-R	22.0	22.65	1.62	1.67	0.107	17.0
DR73-330-R	33.0	34.41	1.31	1.35	0.166	21.0
DR73-470-R	47.0	48.62	1.08	1.14	0.241	24.9
DR73-680-R	68.0	68.91	0.89	0.96	0.358	29.7
DR73-820-R	82.0	80.37	0.86	0.89	0.384	32.1
DR73-101-R	100	101.4	0.73	0.79	0.527	36.0
DR73-151-R	150	150.9	0.58	0.65	0.851	44.0
DR73-221-R	220	223.3	0.52	0.53	1.05	53.5
DR73-331-R	330	325.5	0.42	0.44	1.59	64.5
DR73-471-R	470	465.8	0.35	0.37	2.36	77.2
DR73-681-R	680	676.5	0.29	0.31	3.47	93.1
DR73-821-R	820	821.7	0.27	0.28	3.93	103
DR73-102-R	1000	995.0	0.26	0.25	4.34	113

1. Open Circuit Inductance Test Parameters: 100kHz, 0.25V<sub>rms</sub>, 0.0A<sub>dc</sub>.
2. RMS current for an approximate DT of 40°C without core loss. It is recommended that the temperature of the part not exceed 125°C.
3. Peak current for approximate 30% roll off at 20°C.
4. DCR limits @ 20°C.
5. Applied Volt-Time product (V-μS) across the inductor. This value represent the applied V-μSat 100kHz necessary to generate a core loss equal to 10% of the total losses for 40°C temperature rise.

6. Part number definition: DRxxx-yyy-R
  - DRxxx = product code and size,
  - yyy = inductance value in μH,
  - R = decimal point. If no R is present, third character = # of zeros
  - "-R" suffix = RoHS compliant

**Product specifications**

Part Number	Rated Inductance (μH)	OCL <sup>1</sup> ±20% (μH)	$I_{rms}^2$ Amps	$I_{sat}^3$ Amps Peak	DCR <sup>4</sup> (Ω) Typ.	Volt-μSec <sup>5</sup> Typ.
DR74-R33-R	0.33	0.294	6.26	18.4	0.0074	1.71
DR74-1R0-R	1.00	0.952	5.39	10.2	0.0099	3.08
DR74-1R5-R	1.50	1.422	4.94	8.35	0.0118	3.76
DR74-2R2-R	2.20	1.986	4.76	7.06	0.0126	4.45
DR74-3R3-R	3.30	3.396	3.94	5.40	0.0183	5.81
DR74-4R7-R	4.70	5.182	3.34	4.37	0.0254	7.18
DR74-6R8-R	6.80	7.344	2.60	3.67	0.0418	8.55
DR74-8R2-R	8.20	8.566	2.53	3.40	0.0441	9.23
DR74-100-R	10.0	9.882	2.41	3.17	0.0489	9.92
DR74-150-R	15.0	16.09	2.11	2.48	0.0637	12.7
DR74-220-R	22.0	21.73	1.75	2.13	0.0925	14.7
DR74-330-R	33.0	33.01	1.41	1.73	0.143	18.1
DR74-470-R	47.0	49.64	1.15	1.41	0.216	22.2
DR74-680-R	68.0	69.67	1.03	1.19	0.265	26.3
DR74-820-R	82.0	80.95	0.91	1.11	0.345	28.4
DR74-101-R	100	101.6	0.86	0.99	0.383	31.8
DR74-151-R	150	150.0	0.69	0.81	0.591	38.6
DR74-221-R	220	227.0	0.56	0.66	0.907	47.5
DR74-331-R	330	335.6	0.45	0.54	1.41	57.8
DR74-471-R	470	465.3	0.40	0.46	1.74	68.1
DR74-681-R	680	671.2	0.33	0.38	2.58	81.7
DR74-821-R	820	812.7	0.31	0.35	2.93	89.9
DR74-102-R	1000	1009	0.27	0.31	3.89	100

1. Open Circuit Inductance Test Parameters: 100kHz, 0.25V<sub>rms</sub>, 0.0A<sub>dc</sub>.
2. RMS current for an approximate DT of 40°C without core loss.  
It is recommended that the temperature of the part not exceed 125°C.
3. Peak current for approximate 30% roll off at 20°C.
4. DCR limits @ 20°C.
5. Applied Volt-Time product (V-μS) across the inductor. This value represent the applied V-μSat 100kHz necessary to generate a core loss equal to 10% of the total losses for 40°C temperature rise.

6. Part number definition: DRxxx-yyy-R
  - DRxxx = product code and size,
  - yyy = inductance value in μH,
  - R = decimal point. If no R is present, third character = # of zeros
  - "-R" suffix = RoHS compliant

**Product specifications**

Part Number	Rated Inductance (μH)	OCL <sup>1</sup> ±20% (μH)	I <sub>rms</sub> <sup>2</sup> Amps	I <sub>sat</sub> <sup>3</sup> Amps Peak	DCR <sup>4</sup> (Ω) Typ.	Volt-μSec <sup>5</sup> Typ.
DR125-R47-R	0.47	0.456	17.6	33.0	0.0018	3.17
DR125-1R0-R	1.00	0.894	15.0	23.6	0.0024	4.43
DR125-1R5-R	1.50	1.478	13.8	18.3	0.0029	5.70
DR125-2R2-R	2.20	2.208	10.9	15.0	0.0045	6.97
DR125-3R3-R	3.30	3.084	9.26	12.7	0.0063	8.23
DR125-4R7-R	4.70	5.274	7.18	9.71	0.0105	10.8
DR125-6R8-R	6.80	6.588	6.64	8.68	0.0123	12.0
DR125-8R2-R	8.20	8.048	5.54	7.86	0.0176	13.3
DR125-100-R	10.0	9.654	5.35	7.17	0.0189	14.6
DR125-150-R	15.0	15.35	4.27	5.69	0.0298	18.4
DR125-180-R	18.0	17.70	3.81	5.32	0.0377	19.6
DR125-220-R	22.0	22.36	3.70	4.71	0.0396	22.2
DR125-330-R	33.0	33.74	3.28	3.84	0.0505	27.2
DR125-470-R	47.0	47.47	2.71	3.24	0.0740	32.3
DR125-560-R	56.0	55.24	2.31	3.00	0.102	34.8
DR125-680-R	68.0	67.91	2.22	2.70	0.101	38.6
DR125-820-R	82.0	86.89	2.05	2.39	0.128	43.7
DR125-101-R	100	102.7	1.78	2.20	0.170	47.5
DR125-151-R	150	151.1	1.48	1.81	0.248	57.6
DR125-221-R	220	216.8	1.19	1.51	0.384	69.0
DR125-331-R	330	332.6	1.06	1.22	0.482	85.5
DR125-471-R	470	473.1	0.87	1.02	0.718	102
DR125-681-R	680	679.8	0.70	0.85	1.10	122
DR125-821-R	820	828.0	0.60	0.77	1.49	135
DR125-102-R	1000	1008	0.57	0.70	1.69	149
DR125-472-R	4700	4720	0.268	0.32	7.53	322.4
DR125-124-R	120000	120630	0.060	0.069	150	1521

1. Open Circuit Inductance Test Parameters: 100kHz, 0.25V<sub>rms</sub>, 0.0Adc.
2. RMS current for an approximate DT of 40°C without core loss. It is recommended that the temperature of the part not exceed 125°C.
3. Peak current for approximate 30% roll off at 20°C.
4. DCR limits @ 20°C.
5. Applied Volt-Time product (V-μs) across the inductor. This value represent the applied V-μSat 100kHz necessary to generate a core loss equal to 10% of the total losses for 40°C temperature rise.

6. Part number definition: DRxxx-yyy-R
  - DRxxx = product code and size,
  - yyy = inductance value in μH,
  - R = decimal point. If no R is present, third character = # of zeros
  - "-R" suffix = RoHS compliant

**Product specifications**

Part Number	Rated Inductance (μH)	OCL <sup>1</sup> ±20% (μH)	I <sub>rms</sub> <sup>2</sup> Amps	I <sub>sat</sub> <sup>3</sup> Amps Peak	DCR <sup>4</sup> (Ω) Typ.	Volt-μSec <sup>5</sup> Typ.
DR127-R47-R	0.47	0.419	17.9	56.0	0.00195	3.50
DR127-1R0-R	1.00	0.821	15.5	40.0	0.00313	4.90
DR127-1R5-R	1.50	1.357	13.5	31.1	0.00341	6.30
DR127-2R2-R	2.20	2.027	12.5	25.5	0.00402	7.70
DR127-3R3-R	3.30	2.831	10.5	21.5	0.00567	9.10
DR127-4R7-R	4.70	4.841	8.25	16.5	0.00917	11.9
DR127-6R8-R	6.80	7.387	7.34	13.3	0.0116	14.7
DR127-8R2-R	8.20	8.861	6.32	12.2	0.0157	16.1
DR127-100-R	10.0	10.47	6.04	11.2	0.0172	17.5
DR127-150-R	15.0	14.09	5.03	9.66	0.0247	20.3
DR127-220-R	22.0	22.93	4.00	7.57	0.0391	25.9
DR127-330-R	33.0	33.92	3.23	6.22	0.0600	31.5
DR127-470-R	47.0	47.05	2.95	5.28	0.0719	37.1
DR127-680-R	68.0	66.48	2.44	4.44	0.105	44.1
DR127-820-R	82.0	79.75	2.09	4.06	0.143	48.3
DR127-101-R	100	99.31	1.96	3.64	0.163	53.9
DR127-151-R	150	144.9	1.59	3.01	0.247	65.1
DR127-221-R	220	221.5	1.29	2.43	0.376	80.5
DR127-331-R	330	323.6	1.04	2.01	0.574	97.3
DR127-471-R	470	467.1	0.85	1.68	0.861	117
DR127-681-R	680	676.7	0.76	1.39	1.08	141
DR127-821-R	820	818.1	0.65	1.27	1.47	155
DR127-102-R	1000	1005	0.61	1.14	1.66	172

1. Open Circuit Inductance Test Parameters: 100kHz, 0.25V<sub>rms</sub>, 0.0Adc.
2. RMS current for an approximate DT of 40°C without core loss. It is recommended that the temperature of the part not exceed 125°C.
3. Peak current for approximate 30% roll off at 20°C.
4. DCR limits @ 20°C.
5. Applied Volt-Time product (V-μs) across the inductor. This value represent the applied V-μSat 100kHz necessary to generate a core loss equal to 10% of the total losses for 40°C temperature rise.

6. Part number definition: DRxxx-yyy-R
  - DRxxx = product code and size,
  - yyy = inductance value in μH,
  - R = decimal point. If no R is present, third character = # of zeros
  - "-R" suffix = RoHS compliant

**Dimensions - mm**

**DR73 Series**

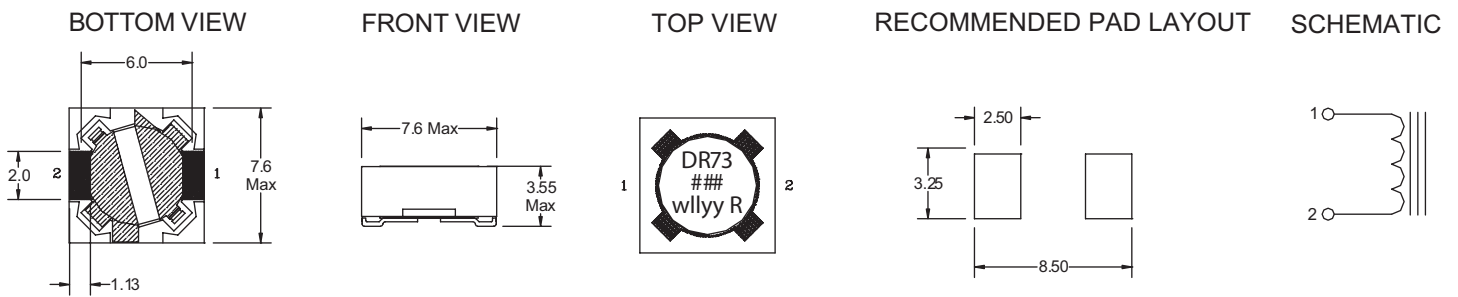

**DR74 Series**

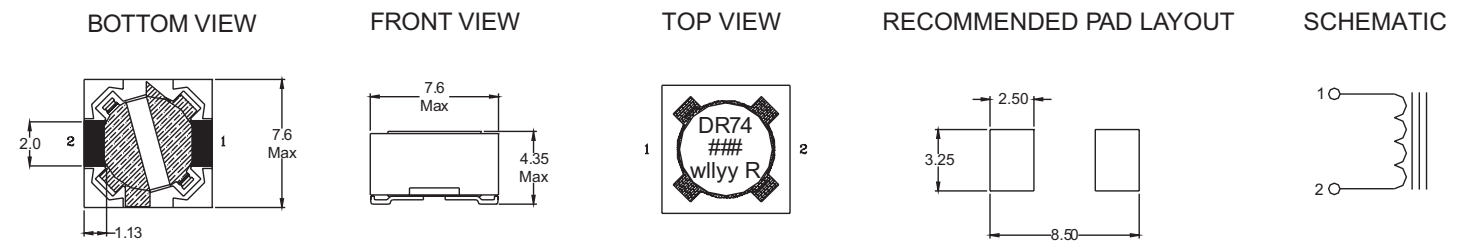

**DR125 Series**

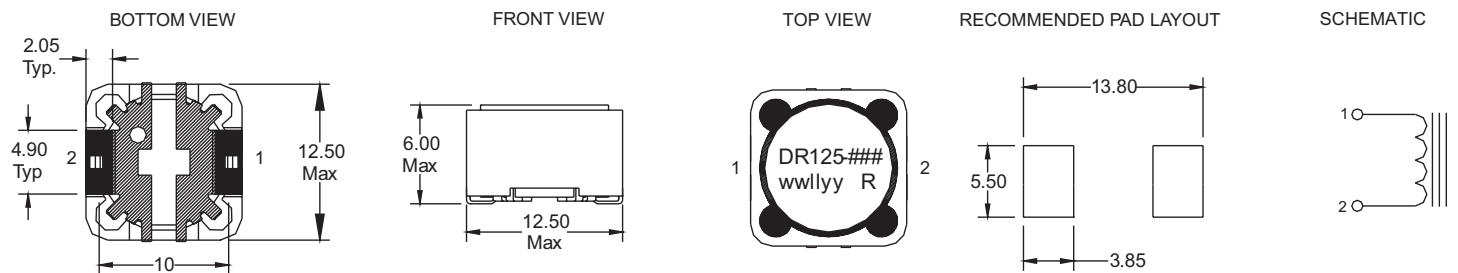

**DR127 Series**

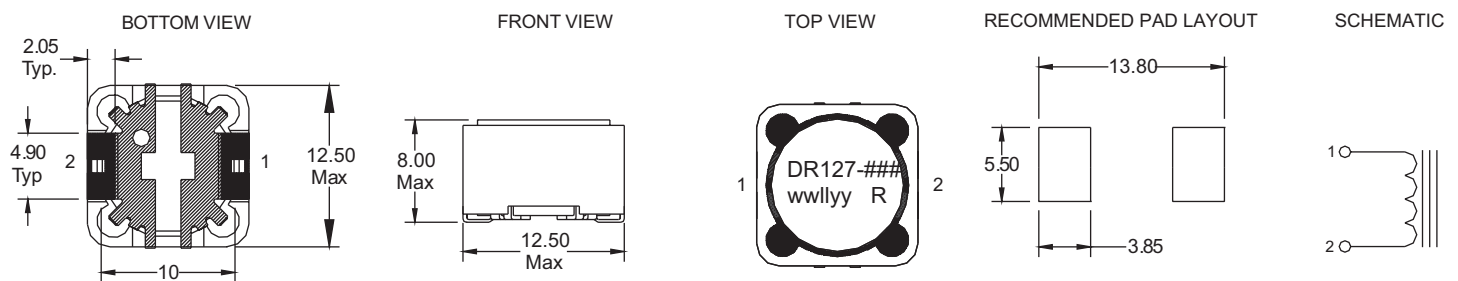

### = Inductance value per family chart  
wllly and wwllly = (date code) R = revision level

**Packaging information - mm**

**DR73 Series**

Supplied in tape and reel packaging,  
1350 parts per reel, 13" diameter reel.

Ao=7.90mm

Bo=7.90mm

Ko=3.80mm

SECTION A-A

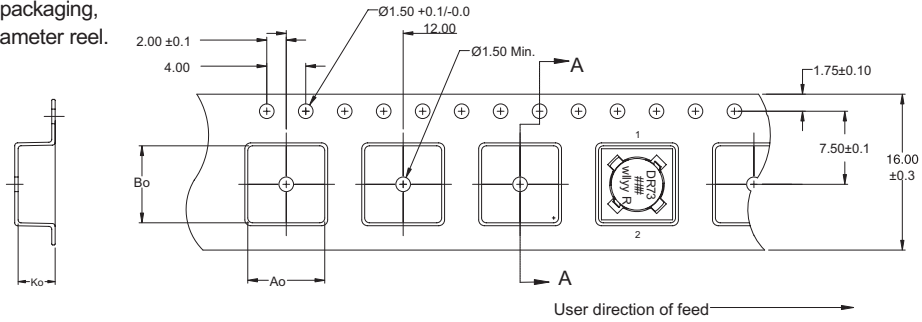

**DR74 Series**

Supplied in tape and reel packaging,  
1100 parts per reel, 13" diameter reel.

Ao=7.90mm

Bo=7.90mm

Ko=4.70mm

SECTION A-A

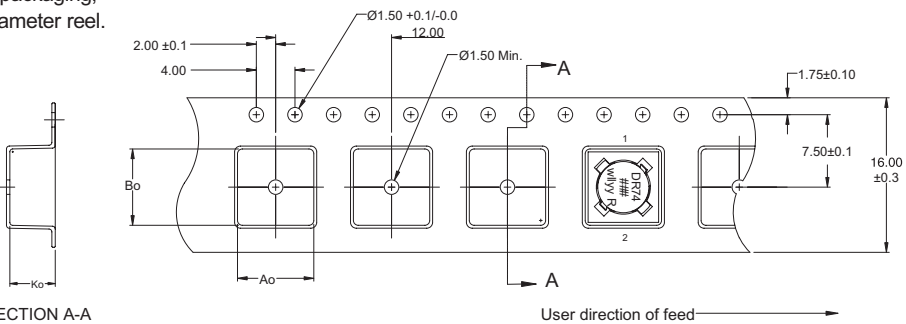

**DR125 Series**

Supplied in tape and reel packaging,  
600 parts per reel, 13" diameter reel

Ao=13.0mm

Bo=13.0mm

Ko=6.30mm

SECTION A-A

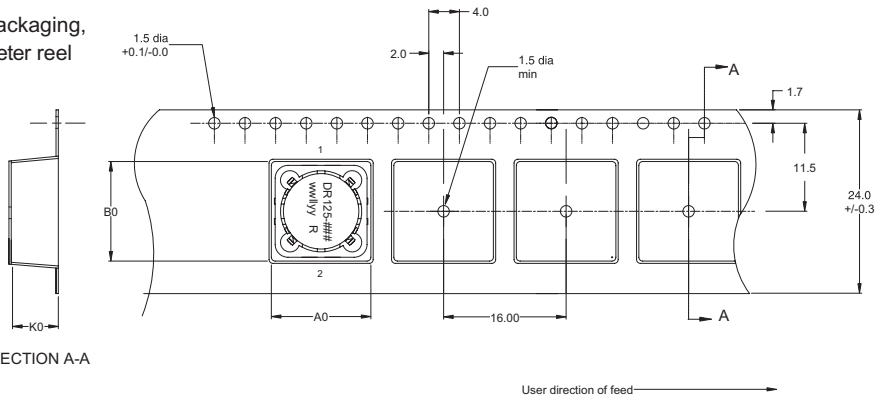

**DR127 Series**

Supplied in tape and reel packaging,  
350 parts per reel, 13" diameter reel.

Ao=13.0mm

Bo=13.0mm

Ko=8.30mm

SECTION A-A

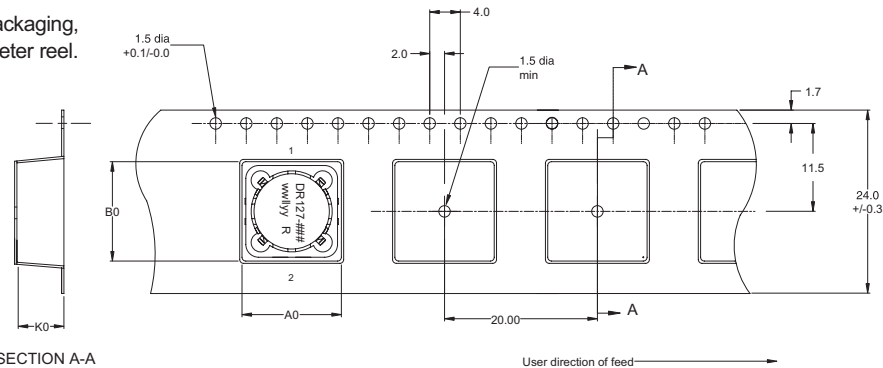

Inductance characteristics

OCL vs  $I_{sat}$  DR73

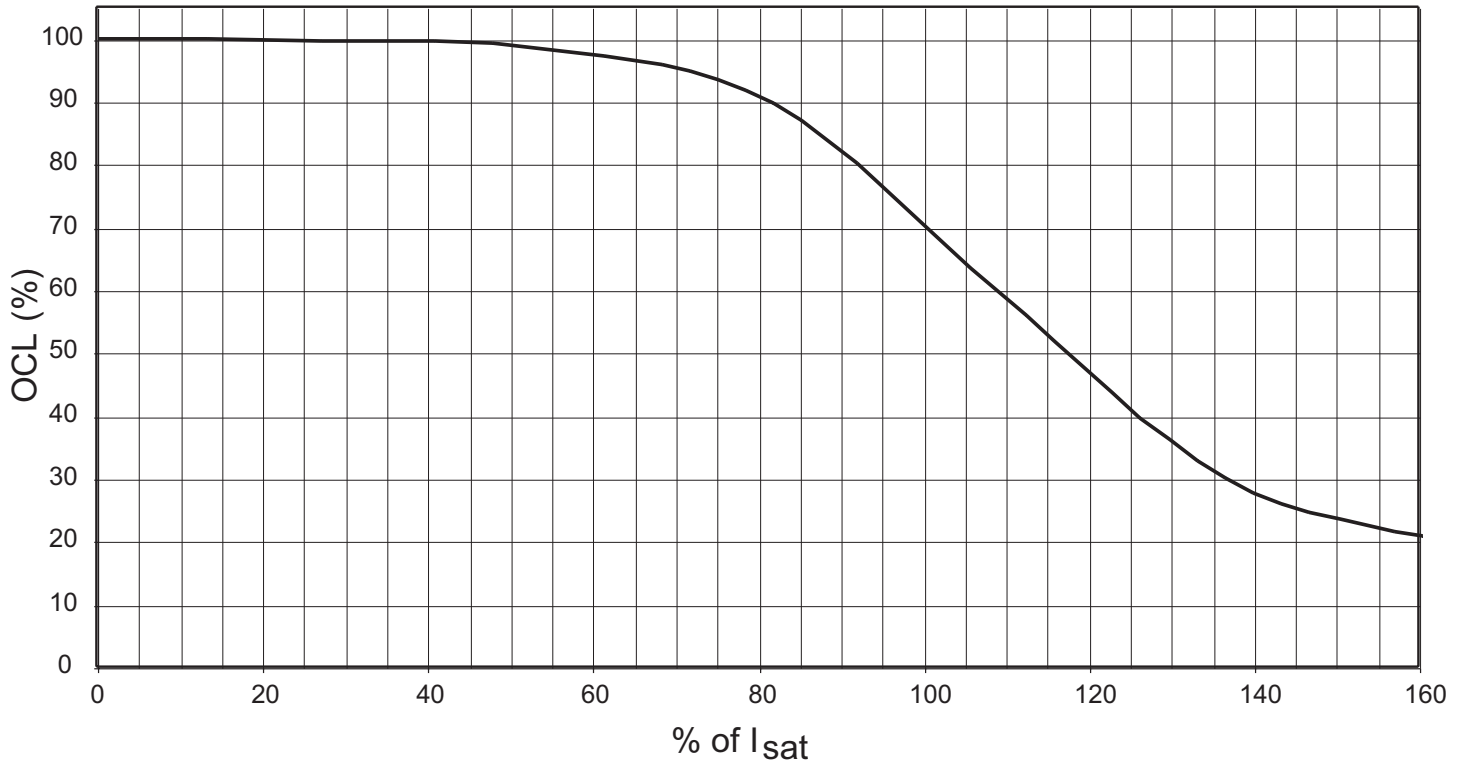

OCL vs  $I_{sat}$  DR74

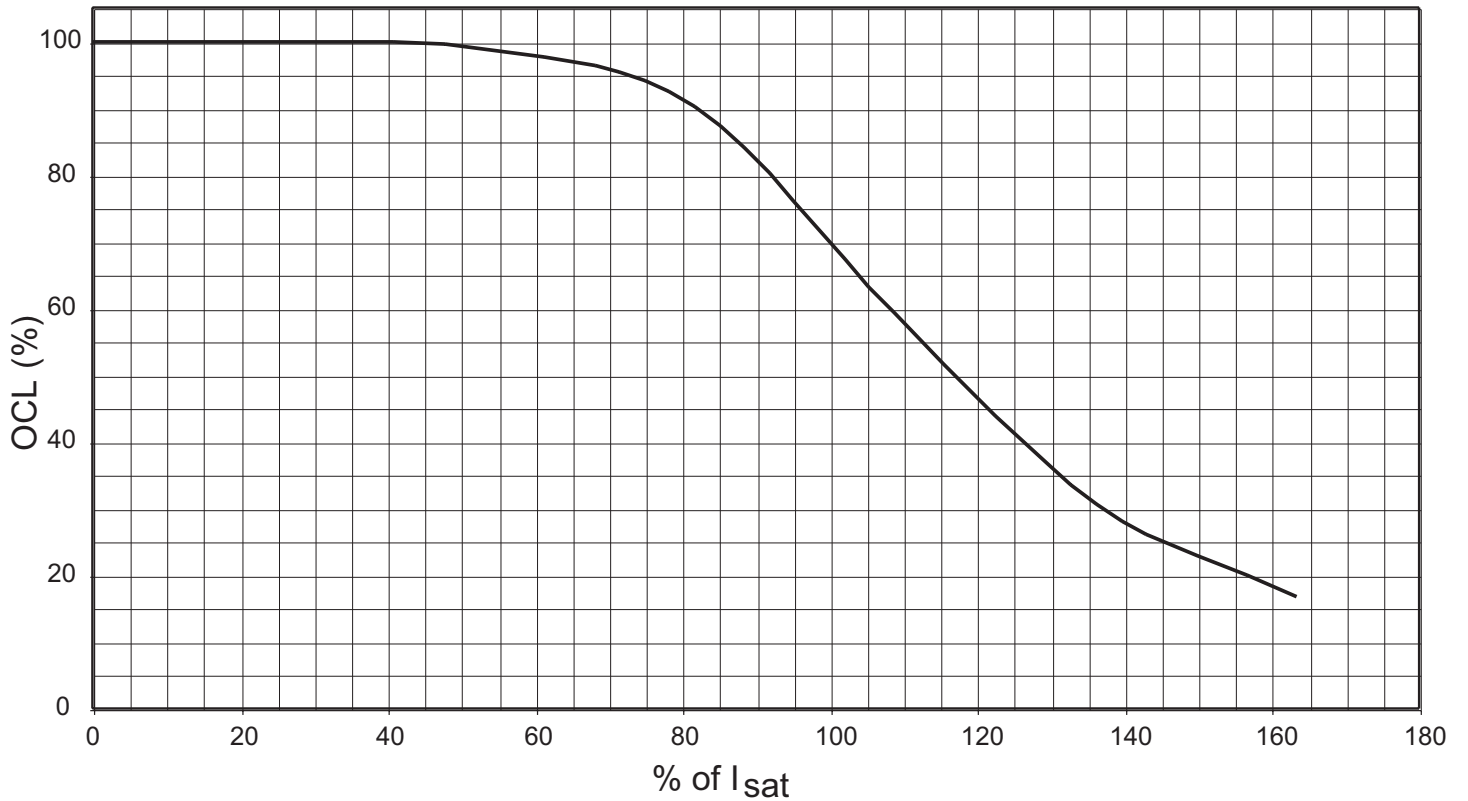



Inductance characteristics

OCL vs  $I_{sat}$  DR125

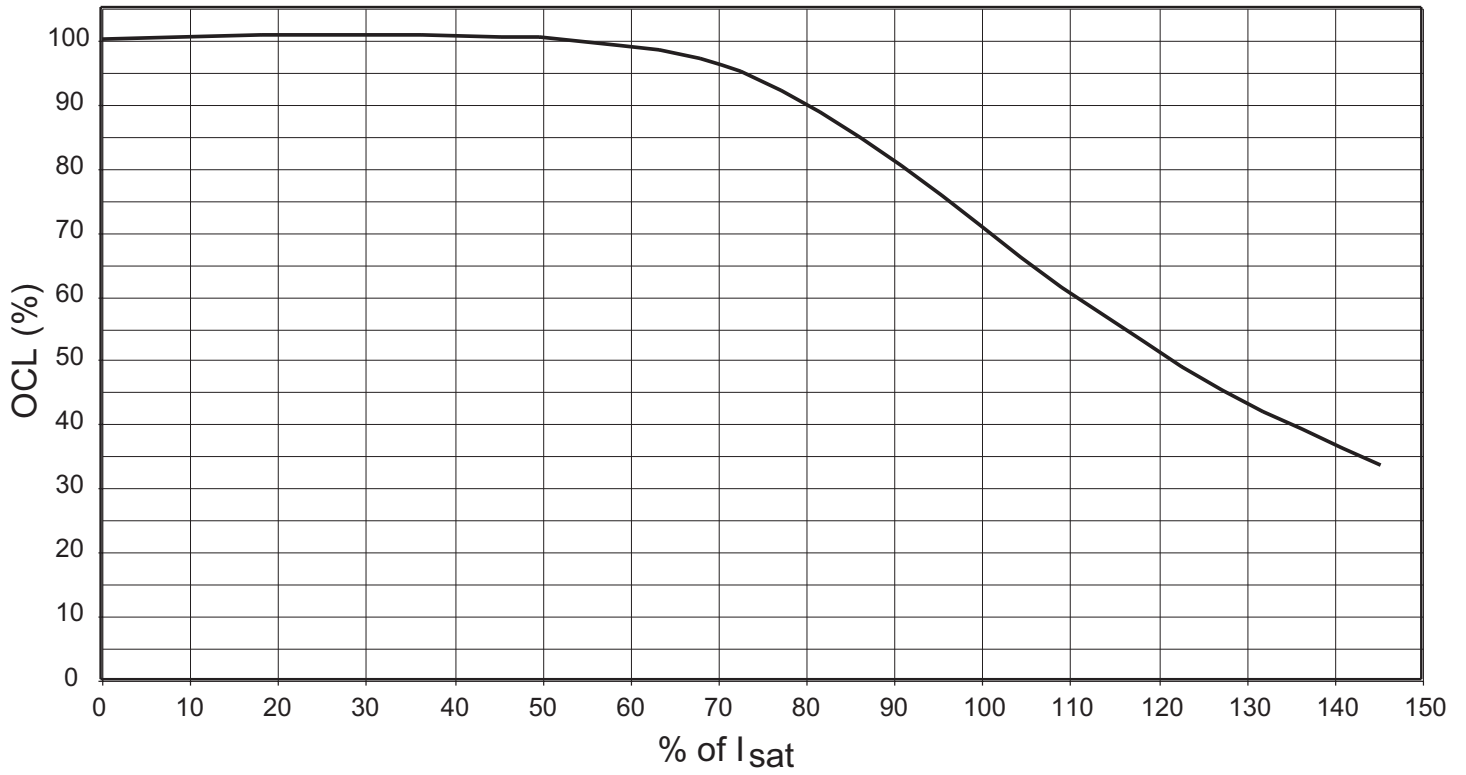

OCL vs  $I_{sat}$  DR127

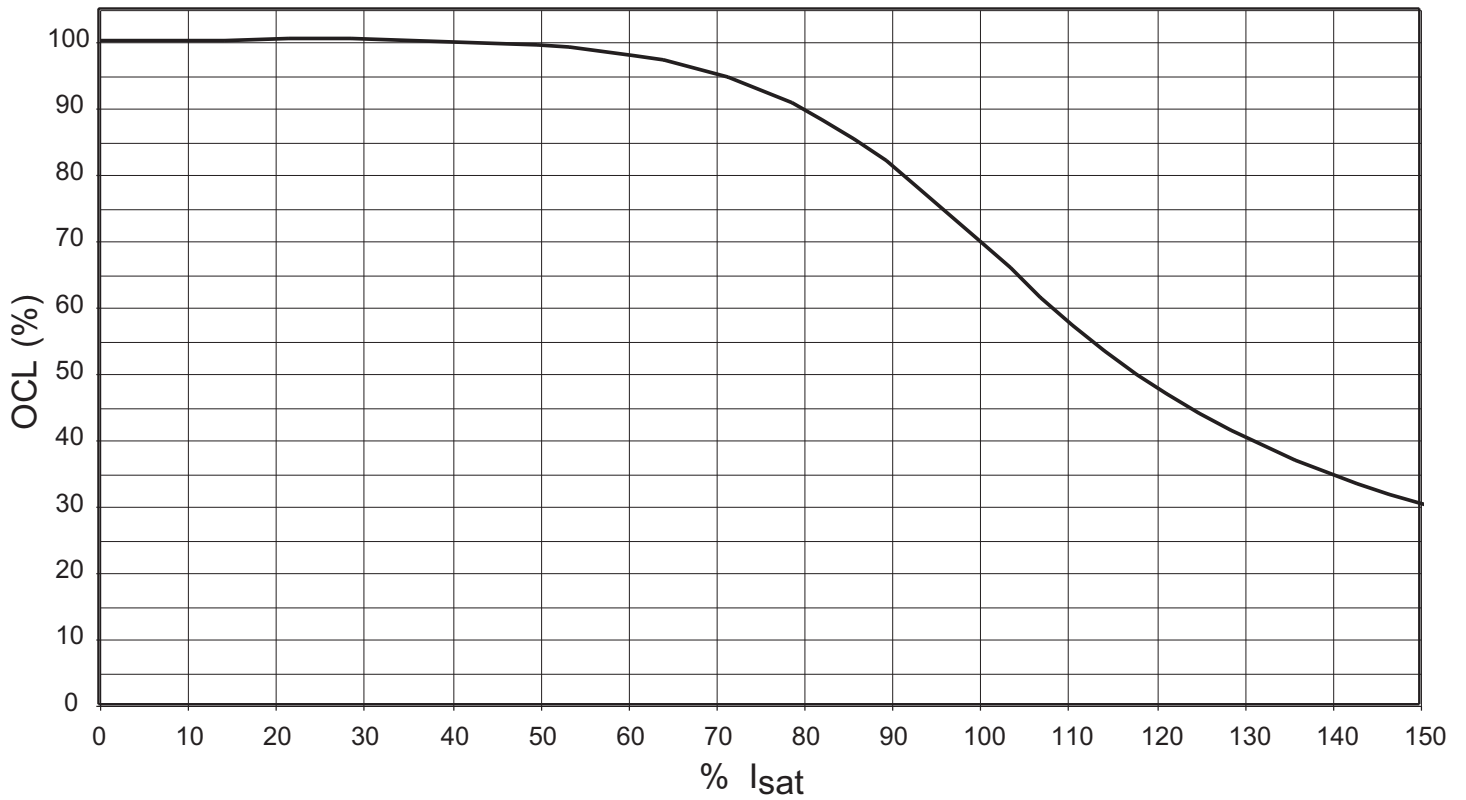

Core loss

$I_{rms}$  Derating with Core Loss

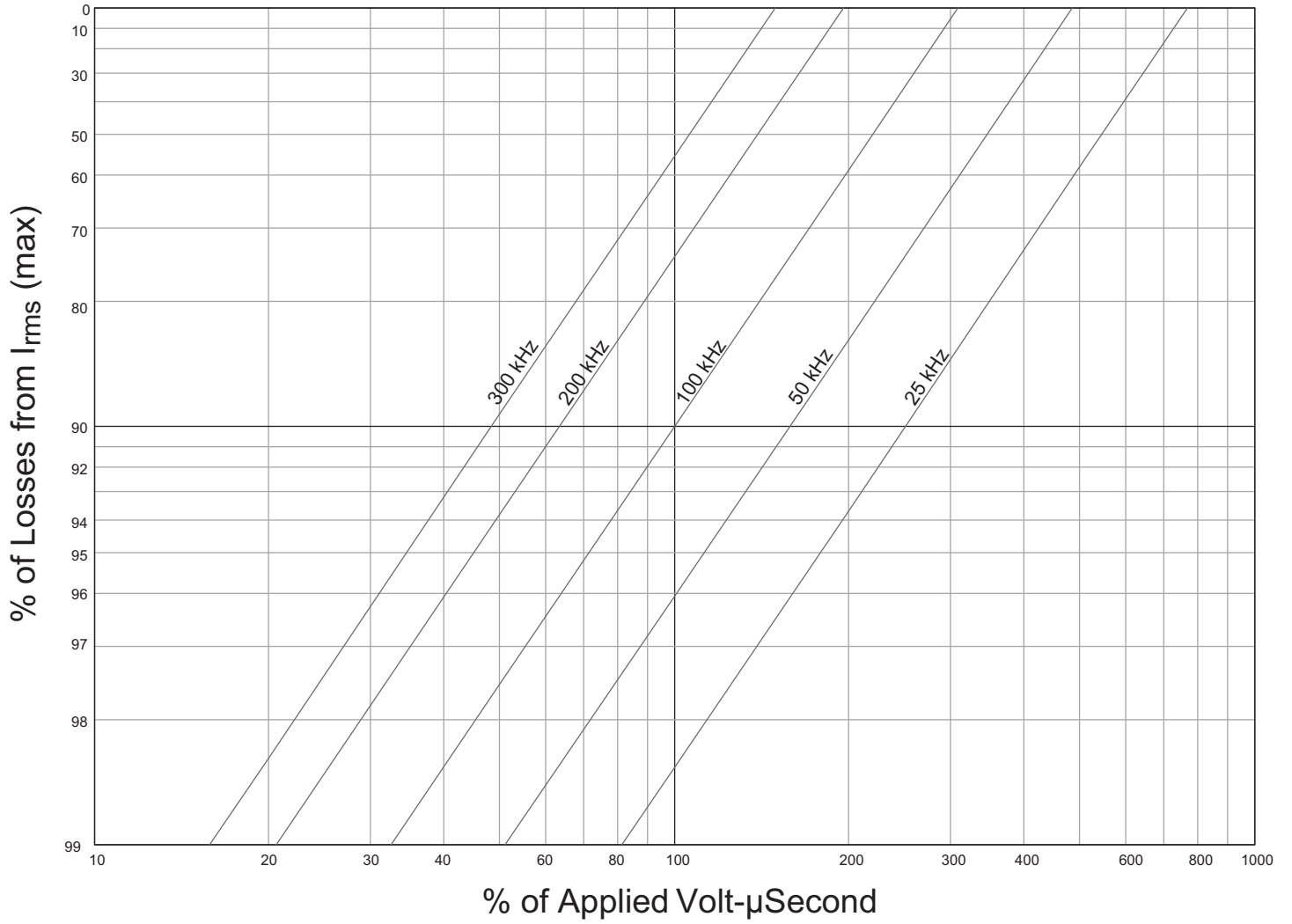

**Solder reflow profile**

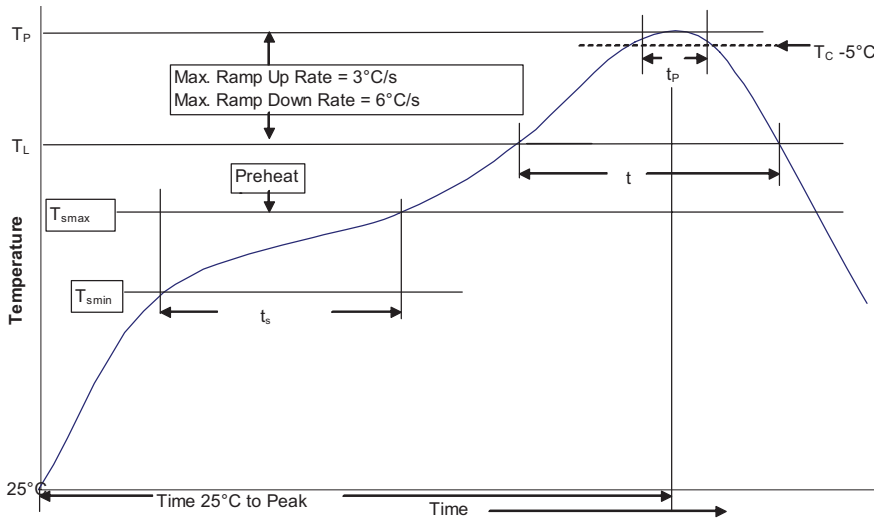

**Table 1 - Standard SnPb Solder ( $T_c$ )**

Package Thickness	Volume $\text{mm}^3$ <350	Volume $\text{mm}^3$ $\geq 350$
<2.5mm	235°C	220°C
$\geq 2.5\text{mm}$	220°C	220°C

**Table 2 - Lead (Pb) Free Solder ( $T_c$ )**

Package Thickness	Volume $\text{mm}^3$ <350	Volume $\text{mm}^3$ 350 - 2000	Volume $\text{mm}^3$ >2000
<1.6mm	260°C	260°C	260°C
1.6 – 2.5mm	260°C	250°C	245°C
>2.5mm	250°C	245°C	245°C

**Reference JEDEC J-STD-020D**

Profile Feature	Standard SnPb Solder	Lead (Pb) Free Solder
Preheat and Soak		
• Temperature min. ( $T_{smin}$ )	100°C	150°C
• Temperature max. ( $T_{smax}$ )	150°C	200°C
• Time ( $T_{smin}$ to $T_{smax}$ ) ( $t_s$ )	60-120 Seconds	60-120 Seconds
Average ramp up rate $T_{smax}$ to $T_p$	3°C/ Second Max.	3°C/ Second Max.
Liquidous temperature ( $T_L$ )	183°C	217°C
Time at liquidous ( $t_L$ )	60-150 Seconds	60-150 Seconds
Peak package body temperature ( $T_p$ )*	Table 1	Table 2
Time ( $t_p$ )** within 5 °C of the specified classification temperature ( $T_c$ )	20 Seconds**	30 Seconds**
Average ramp-down rate ( $T_p$ to $T_{smax}$ )	6°C/ Second Max.	6°C/ Second Max.
Time 25°C to Peak Temperature	6 Minutes Max.	8 Minutes Max.

\* Tolerance for peak profile temperature ( $T_p$ ) is defined as a supplier minimum and a user maximum.

\*\* Tolerance for time at peak profile temperature ( $t_p$ ) is defined as a supplier minimum and a user maximum.

**North America**

Eaton's Electrical Group  
Electronics Division  
1225 Broken Sound Parkway NW  
Suite F  
Boca Raton, FL 33487-3533  
Tel: 1-561-998-4100  
Fax: 1-561-241-6640  
Toll Free: 1-888-414-2645

Eaton's Electrical Group  
Electronics Division  
P.O. Box 14460  
St. Louis, MO 63178-4460  
Tel: 1-636-394-2877  
Fax: 1-636-527-1607

**Europe**

Eaton's Electrical Group  
Electronics Division  
Burton-on-the-Wolds  
Leicestershire, LE 12 5th UK  
Phone: +44 (0) 1509 882 600  
Fax: +44 (0) 1509 882 786

Eaton's Electrical Group  
Electronics Division  
Avda Santa Eulalia, 290  
Terrassa, Barcelona 08223 Spain  
Phone: +34-93-736-2813  
Fax: +34-93-783-5055

**Asia Pacific**

Eaton's Electrical Group  
Electronics Division  
No.2, #06-01  
Serangoon North Avenue 5  
Singapore 554911  
Tel: +65 6645 9888  
Fax: +65 6728 3155

The only controlled copy of this Data Sheet is the electronic read-only version located on the Bussmann Network Drive. All other copies of this document are by definition uncontrolled. This bulletin is intended to clearly present comprehensive product data and provide technical information that will help the end user with design applications. Bussmann reserves the right, without notice, to change design or construction of any products and to discontinue or limit distribution of any products. Bussmann also reserves the right to change or update, without notice, any technical information contained in this bulletin. Once a product has been selected, it should be tested by the user in all possible applications.

Life Support Policy: Bussmann does not authorize the use of any of its products for use in life support devices or systems without the express written approval of an officer of the Company. Life support systems are devices which support or sustain life, and whose failure to perform, when properly used in accordance with instructions for use provided in the labeling, can be reasonably expected to result in significant injury to the user.

**Eaton's Electrical Group  
Electronics Division**  
114 Old State Road  
Ellisville, MO 63021  
United States  
www.eaton.com/elx



Powering Business Worldwide

© 2014 Eaton  
All Rights Reserved  
Publication No. 4315 – BU-SB14112  
April 2014

Eaton is a registered trademark.

All other trademarks are property of their respective owners.

www.eaton.com/elx