



## 3-TERMINAL FILTERS

Feedthrough filter for power line

# YFF-P series

---

<b>YFF15PC</b>	<b>1005 [0402 inch]*</b>	<b>Feedthrough filter</b>
<b>YFF18PC</b>	<b>1608 [0603 inch]*</b>	<b>Feedthrough filter</b>
<b>YFF18PH</b>	<b>1608 [0603 inch]*</b>	<b>Feedthrough filter (thickness: 0.8mm)</b>
<b>YFF18PW</b>	<b>1608 [0603 inch]*</b>	<b>Feedthrough filter (low ESL type)</b>
<b>YFF21PC</b>	<b>2012 [0805 inch]*</b>	<b>Feedthrough filter</b>
<b>YFF31PC</b>	<b>3216 [1206 inch]*</b>	<b>Feedthrough filter</b>

\* Dimensions code JIS[EIA]

---

## 3-TERMINAL FILTERS

### Feedthrough filter for power line

Conformity to RoHS directive  
Compatible with lead-free solders

# Overview of YFF-P series

## FEATURES

- Small and high-performance EMC components.
- Good attenuation characteristics in a wide frequency band.
- For large current (2A to 4A) applications.

## APPLICATIONS

For power lines of telecommunication terminal devices including smartphones, audio-visual equipment, and information equipment.

## PART NUMBER CONSTRUCTION

YFF		15		PC		0G		435		M		T		□□		0		N	
Series name	L x W dimensions		Product internal code		Rated voltage		Capacitance		Tolerance		Taping	TDK internal code	Reel size		Internal electrode Ni				
	Code	mm			Code	V	Code	pF					Code	mm					
	15	1.0x0.5	PC	STD	0G	4	104	100,000	M	±20%			0	ø178					
	18	1.6x0.8	PH	Thickness 0.8mm	0J	6.3	105	1,000,000 (1.0µF)					9	ø330					
	21	2.0x1.2					1A	10											
	31	3.2x1.6	PW	Low ESL	1C	16	435	4,300,000 (4.3µF)											
					1E	25	226	22,000,000 (22µF)											

## PACKAGING STYLE AND SPECIFICATIONS

Type	Package quantity (piece/reel)		Unit weight (g)
	ø178 (mm)	ø330 (mm)	
YFF15PC	10,000	50,000	0.0008
YFF15PC0G435M	10,000	50,000	0.0015
YFF15PC0G755M	10,000	50,000	0.0027
YFF15PC0G106M	10,000	50,000	0.0029
YFF18PC	4,000	10,000	0.0038
YFF18PH	4,000	10,000	0.0051
YFF18PW	4,000	10,000	0.0038
YFF21PC	4,000	10,000	0.0095
YFF31PC	2,000	10,000	0.0342

- RoHS Directive Compliant Product: See the following for more details. <https://product.tdk.com/info/en/environment/rohs/index.html>
- Halogen-free: Indicates that Cl content is less than 900ppm, Br content is less than 900ppm, and that the total Cl and Br content is less than 1500ppm.

 Please be sure to request delivery specifications that provide further details on the features and specifications of the products for proper and safe use.  
Please note that the contents may change without any prior notice due to reasons such as upgrading.

# Overview of YFF-P series

## RECOMMENDED SOLDERING CONDITION

### REFLOW SOLDERING

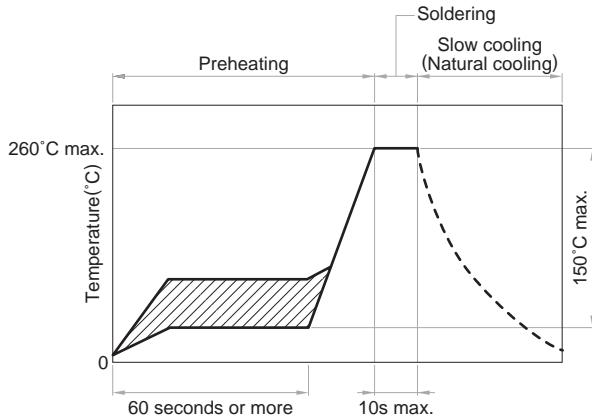

### HAND SOLDERING

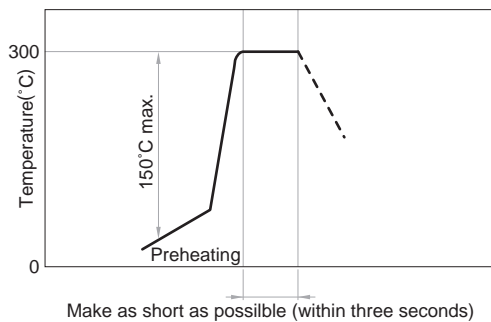

## REMINDERS FOR USING THESE PRODUCTS

- Before soldering, be sure to preheat components. The  $\Delta T$  preheating temperature must be 150°C max. with attention paid to thermal shock.
- Natural cooling of components in the air is recommended. On the other hand, when dipping them in a solvent for purposes, such as cleaning, make sure that the temperature difference ( $\Delta T$ ) is 100°C.
- When performing hand soldering for circuit modification, apply the soldering iron to the copper foil area of the printed circuit board for 3 seconds or less. The temperature of the iron tip should not exceed 300°C.
- Use a wrist band to discharge static electricity in your body through the grounding wire.
- When incorporating the printed circuit board on which this product is mounted into a frame, etc., do not apply stress to the product through local bending of the board by tightening of screws, etc.

# YFF-P series YFF15PC type

## SHAPE & DIMENSIONS

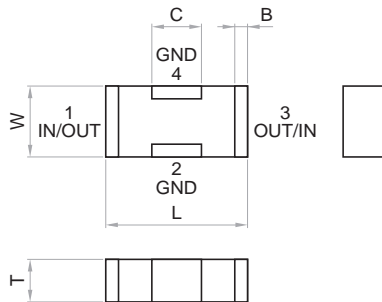

## RECOMMENDED LAND PATTERN

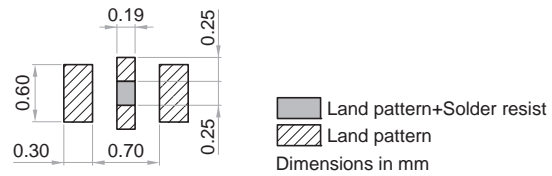

Part No.	L (mm)	W (mm)	T (mm)	B (mm)	C (mm)
YFF15PC0G106MT00□N	1.00±0.20	0.50±0.20	0.50±0.15	0.07min.	0.35±0.10
YFF15PC0G755MT00□N	1.00±0.20	0.50±0.15	0.50±0.15	0.07min.	0.35±0.10
YFF15PC0G435MT00□N	1.05±0.05	0.65±0.05	0.45±0.05	0.09min.	0.30±0.10
YFF15PC0G105MT00□N	1.00±0.05	0.55±0.05	0.30±0.05	0.09min.	0.30±0.10
YFF15PC0J474MT00□N	1.00±0.05	0.55±0.05	0.30±0.05	0.09min.	0.30±0.10
YFF15PC1A224MT00□N	1.00±0.05	0.55±0.05	0.30±0.05	0.09min.	0.30±0.10
YFF15PC1C104MT00□N	1.00±0.05	0.55±0.05	0.30±0.05	0.09min.	0.30±0.10

\* Make sure to connect the GND terminal of this product and the GND of the mounting circuit board by using through holes so that the distance between them is the shortest.

## ELECTRICAL CHARACTERISTICS

### CHARACTERISTICS SPECIFICATION TABLES

Insertion loss 40dB frequency range (MHz)	Rated voltage	Rated current	Operating temperature range (°C)	Storage temperature range (After mounting) (°C)	Part No.*
	Edc (V)	Idc (A)			
0.07 to 1000	4	2	-55 to 85	-55 to 85	YFF15PC0G106MT00 □ N
0.11 to 1000	4	2	-55 to 85	-55 to 85	YFF15PC0G755MT00 □ N
0.2 to 1000	4	2	-55 to 85	-55 to 85	YFF15PC0G435MT00 □ N
0.8 to 1000	4	3	-55 to 105	-55 to 105	YFF15PC0G105MT00 □ N
2 to 1000	6.3	3	-55 to 105	-55 to 105	YFF15PC0J474MT00 □ N
4 to 1000	10	3	-55 to 105	-55 to 105	YFF15PC1A224MT00 □ N
9 to 1000	16	3	-55 to 105	-55 to 105	YFF15PC1C104MT00 □ N

\* The part numbers are TDK's standard specification products.

\* □: Reel size code, 0 (ø178) or 9 (ø330).

## ELECTRICAL CHARACTERISTICS GRAPH

### INSERTION LOSS vs. FREQUENCY CHARACTERISTICS

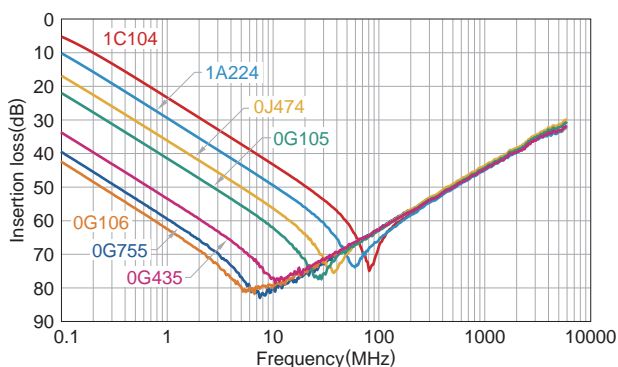

### RATED CURRENT vs. TEMPERATURE CHARACTERISTICS (DERATING)

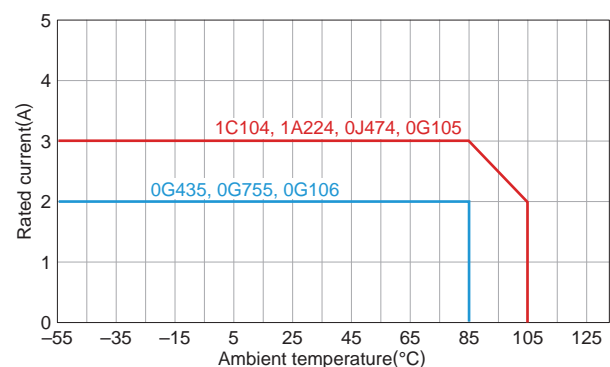

⚠ Please be sure to request delivery specifications that provide further details on the features and specifications of the products for proper and safe use.  
Please note that the contents may change without any prior notice due to reasons such as upgrading.

# YFF-P series YFF18PC type

## SHAPE & DIMENSIONS

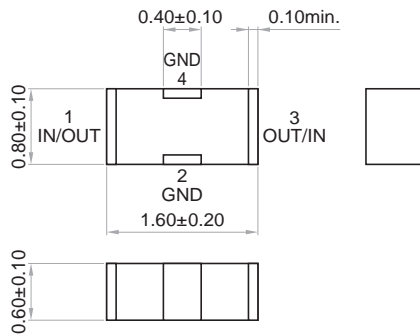

## RECOMMENDED LAND PATTERN

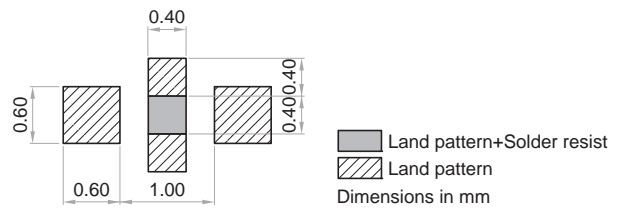

\* Make sure to connect the GND terminal of this product and the GND of the mounting circuit board by using through holes so that the distance between them is the shortest.

## ELECTRICAL CHARACTERISTICS

### CHARACTERISTICS SPECIFICATION TABLES

Insertion loss 40dB frequency range (MHz)	Rated voltage Edc (V)	Rated current Idc (A)	Operating temperature range (°C)	Storage temperature range (After mounting) (°C)	Part No.*
0.2 to 1000	6.3	4	-55 to 85	-55 to 85	YFF18PC0J475MT0H□N
0.8 to 1000	6.3	4	-55 to 105	-55 to 105	YFF18PC0J105MT0H□N
2 to 1000	6.3	4	-55 to 125	-55 to 125	YFF18PC0J474MT0H□N
3 to 1000	6.3	4	-55 to 125	-55 to 125	YFF18PC0J224MT0H□N
7 to 1000	16	4	-55 to 125	-55 to 125	YFF18PC1C104MT0H□N

\* The part numbers are TDK's standard specification products.

\* □: Reel size code, 0 (ø178) or 9 (ø330).

## ELECTRICAL CHARACTERISTICS GRAPH

### INSERTION LOSS vs. FREQUENCY CHARACTERISTICS

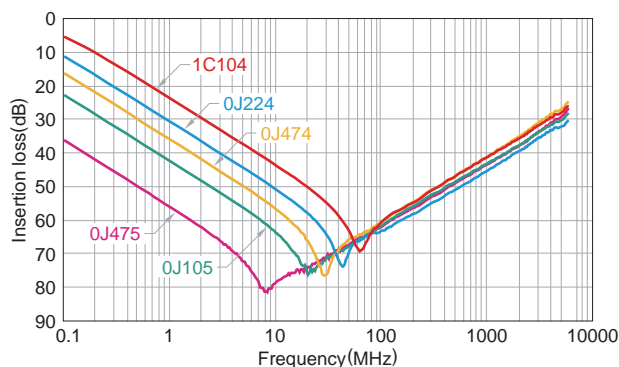

### RATED CURRENT vs. TEMPERATURE CHARACTERISTICS (DERATING)

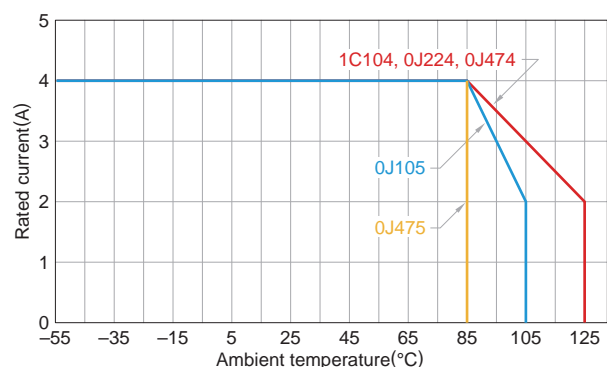

⚠ Please be sure to request delivery specifications that provide further details on the features and specifications of the products for proper and safe use.  
Please note that the contents may change without any prior notice due to reasons such as upgrading.

# YFF-P series YFF18PH type

## SHAPE & DIMENSIONS

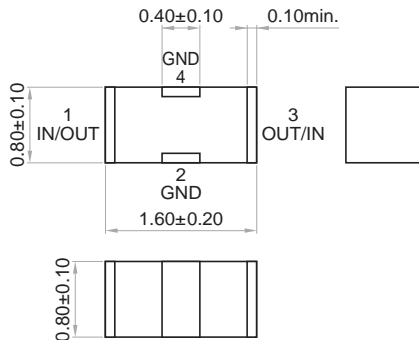

## RECOMMENDED LAND PATTERN

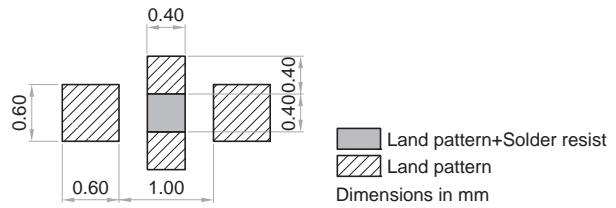

\* Make sure to connect the GND terminal of this product and the GND of the mounting circuit board by using through holes so that the distance between them is the shortest.

## ELECTRICAL CHARACTERISTICS

### CHARACTERISTICS SPECIFICATION TABLES

Insertion loss 40dB frequency range (MHz)	Rated voltage Edc (V)	Rated current Idc (A)	Operating temperature range (°C)	Storage temperature range (After mounting) (°C)	Part No.*
0.4 to 1000	6.3	4	-55 to 85	-55 to 85	YFF18PH0J225MT00□N
0.8 to 1000	6.3	4	-55 to 105	-55 to 105	YFF18PH0J105MT00□N

\* The part numbers are TDK's standard specification products.

\* □: Reel size code, 0 (ø178) or 9 (ø330).

## ELECTRICAL CHARACTERISTICS GRAPH

### INSERTION LOSS vs. FREQUENCY CHARACTERISTICS

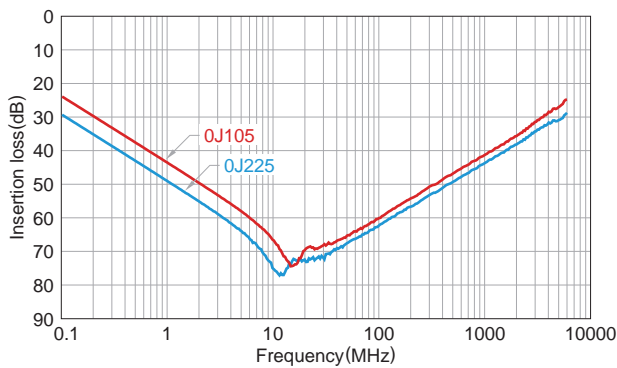

### RATED CURRENT vs. TEMPERATURE CHARACTERISTICS (DERATING)

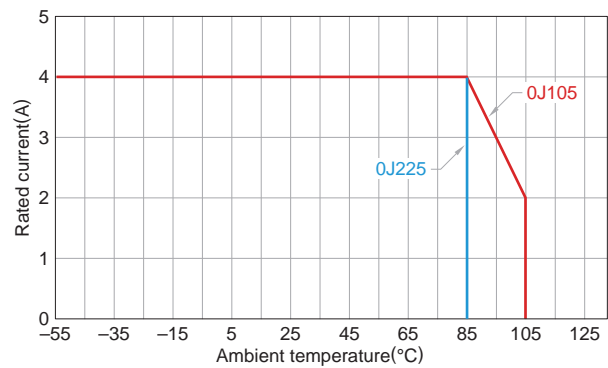

# YFF-P series YFF18PW type

## SHAPE & DIMENSIONS

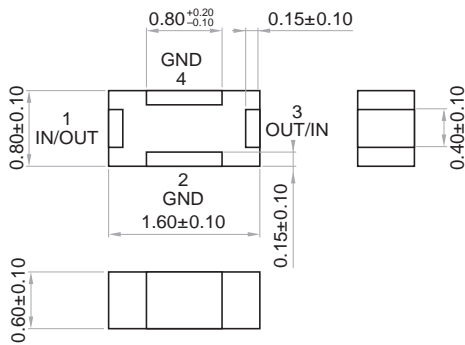

## RECOMMENDED LAND PATTERN

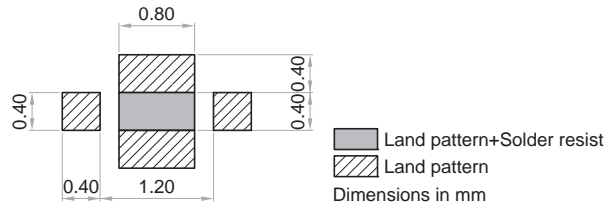

\* Make sure to connect the GND terminal of this product and the GND of the mounting circuit board by using through holes so that the distance between them is the shortest.

## ELECTRICAL CHARACTERISTICS

### CHARACTERISTICS SPECIFICATION TABLES

Insertion loss 40dB frequency range (MHz)	Rated voltage Edc (V)	Rated current Idc (A)	Operating temperature range (°C)	Storage temperature range (After mounting) (°C)	Part No.*
0.2 to 2000	6.3	4	-55 to 85	-55 to 85	YFF18PW0J475MT0H□N
0.8 to 2000	6.3	4	-55 to 105	-55 to 105	YFF18PW0J105MT0H□N
2 to 2000	6.3	4	-55 to 125	-55 to 125	YFF18PW0J474MT0H□N

\* The part numbers are TDK's standard specification products.

\* □: Reel size code, 0 (ø178) or 9 (ø330).

## ELECTRICAL CHARACTERISTICS GRAPH

### INSERTION LOSS vs. FREQUENCY CHARACTERISTICS

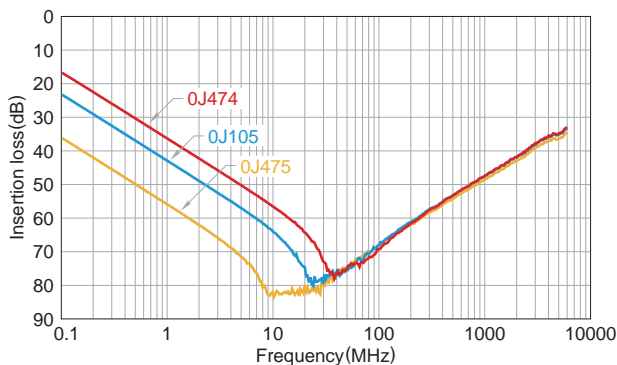

### RATED CURRENT vs. TEMPERATURE CHARACTERISTICS (DERATING)

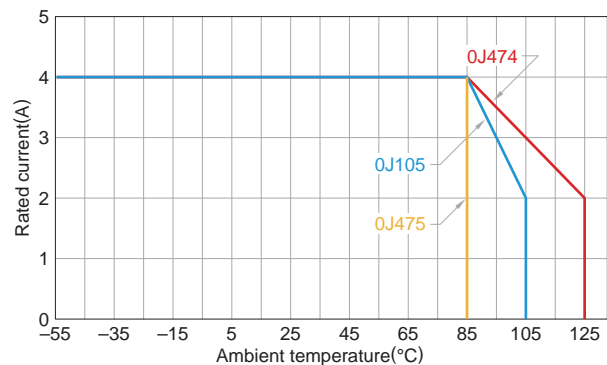

⚠ Please be sure to request delivery specifications that provide further details on the features and specifications of the products for proper and safe use.  
Please note that the contents may change without any prior notice due to reasons such as upgrading.

# YFF-P series YFF21PC type

## SHAPE & DIMENSIONS

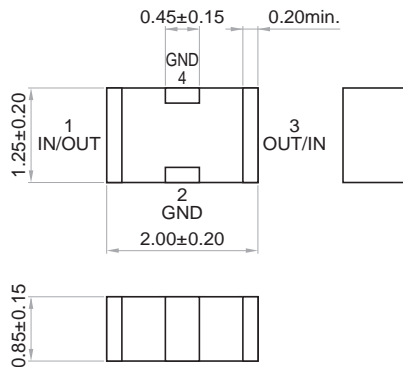

## RECOMMENDED LAND PATTERN

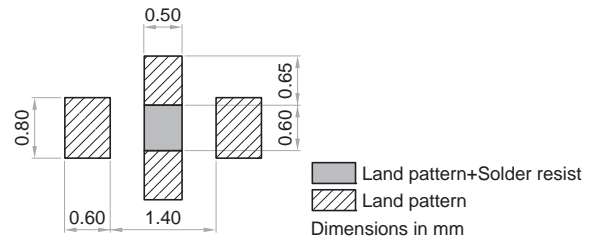

\* Make sure to connect the GND terminal of this product and the GND of the mounting circuit board by using through holes so that the distance between them is the shortest.

## ELECTRICAL CHARACTERISTICS

### CHARACTERISTICS SPECIFICATION TABLES

Insertion loss 40dB frequency range (MHz)	Rated voltage Edc (V)	Rated current Idc (A)	Operating temperature range (°C)	Storage temperature range (After mounting) (°C)	Part No.*
0.04 to 1000	6.3	4	-55 to 85	-55 to 85	YFF21PC0J226MT00□N
0.7 to 1000	10	4	-55 to 85	-55 to 85	YFF21PC1A105MT00□N
2 to 1000	16	2	-55 to 125	-55 to 125	YFF21PC1C474MT00□N
7 to 1000	25	2	-55 to 125	-55 to 125	YFF21PC1E104MT00□N

\* The part numbers are TDK's standard specification products.

\* □: Reel size code, 0 (ø178) or 9 (ø330).

## ELECTRICAL CHARACTERISTICS GRAPH

### INSERTION LOSS vs. FREQUENCY CHARACTERISTICS

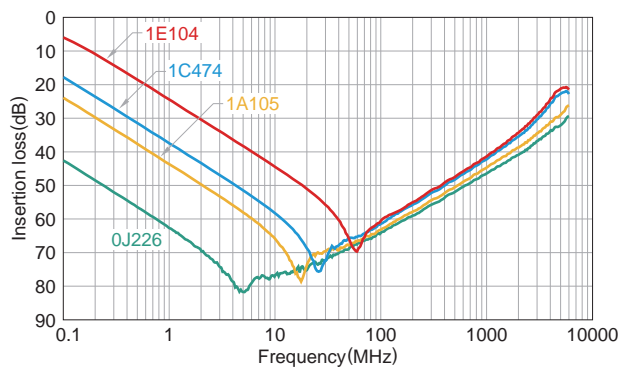

Please be sure to request delivery specifications that provide further details on the features and specifications of the products for proper and safe use. Please note that the contents may change without any prior notice due to reasons such as upgrading.



# YFF-P series YFF31PC type

## SHAPE & DIMENSIONS

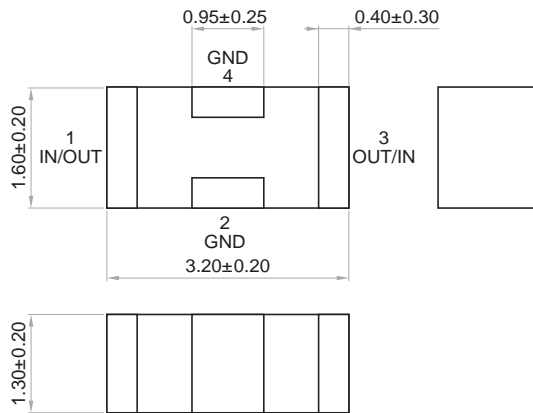

## RECOMMENDED LAND PATTERN

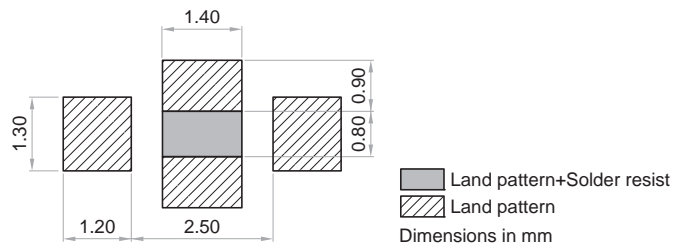

\* Make sure to connect the GND terminal of this product and the GND of the mounting circuit board by using through holes so that the distance between them is the shortest.

## ELECTRICAL CHARACTERISTICS

### CHARACTERISTICS SPECIFICATION TABLES

Insertion loss 40dB frequency range (MHz)	Rated voltage Edc (V)	Rated current Idc (A)	Operating temperature range (°C)	Storage temperature range (After mounting) (°C)	Part No.*
0.7 to 1000	16	2	-55 to 125	-55 to 125	YFF31PC1C105MT00□N
2 to 1000	16	2	-55 to 125	-55 to 125	YFF31PC1C474MT00□N
3 to 600	16	2	-55 to 125	-55 to 125	YFF31PC1C224MT00□N
7 to 1000	16	2	-55 to 125	-55 to 125	YFF31PC1C104MT00□N

\* The part numbers are TDK's standard specification products.

\* □: Reel size code, 0 (ø178) or 9 (ø330).

## ELECTRICAL CHARACTERISTICS GRAPH

### INSERTION LOSS vs. FREQUENCY CHARACTERISTICS

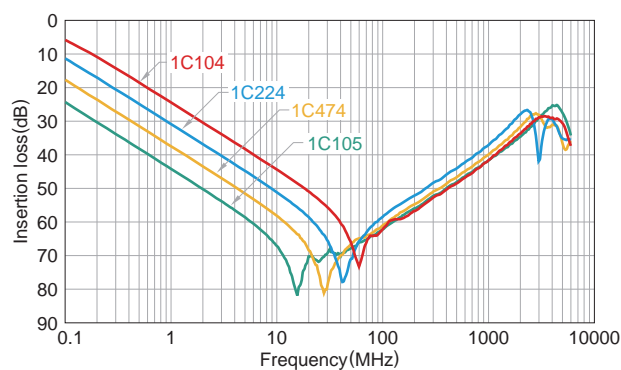

⚠ Please be sure to request delivery specifications that provide further details on the features and specifications of the products for proper and safe use.  
Please note that the contents may change without any prior notice due to reasons such as upgrading.

YFF-P series

# Packaging style

## REEL DIMENSIONS

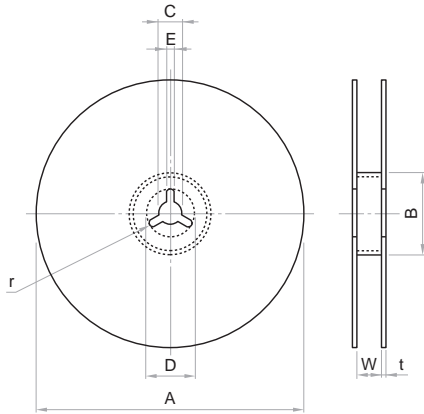

Dimensions in mm

Reel	Dimensions in: mm							
	A	B	C	D	E	W	t	r
ø178	ø178±2.0	ø60±2.0	ø13±0.5	ø21±0.8	2.0±0.5	9.0±0.3	2.0±0.05	1.0
ø330	ø382 max.(ø330 nom.)	ø50 min.	ø13±0.5	ø21±0.8	2.0±0.5	10.0±1.5	2.0±0.05	1.0

## TAPE DIMENSIONS

### Paper tape

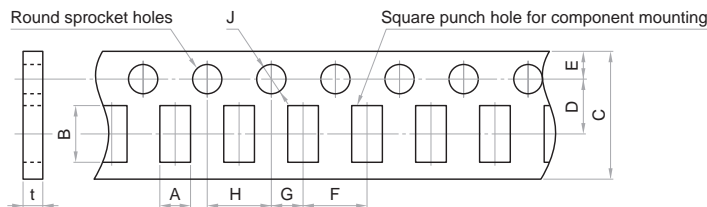

Dimensions in: mm

Type	A	B	C	D	E	F	G	H	J	t
YFF15PC	0.62 typ.	1.12 typ.								0.7 max.
YFF15PC0G435M	0.75 typ.	1.18 typ.	8.00±0.30	3.50±0.05	1.75±0.10	2.00±0.05	2.00±0.05	4.00±0.10	ø1.5+0.1/-0	
YFF15PC0G755M	0.75 typ.	1.30 typ.								0.8 max.
YFF15PC0G106M	0.77 typ.	1.30 typ.								
YFF18PC										
YFF18PH	1.10 typ.	1.90 typ.	8.00±0.30	3.50±0.05	1.75±0.10	4.00±0.10	2.00±0.05	4.00±0.10	ø1.5+0.1/-0	1.2 max.
YFF18PW										
YFF21PC	1.50 typ.	2.30 typ.	8.00±0.30	3.50±0.05	1.75±0.10	4.00±0.10	2.00±0.05	4.00±0.10	ø1.5+0.1/-0	1.2 max.

### Plastic tape

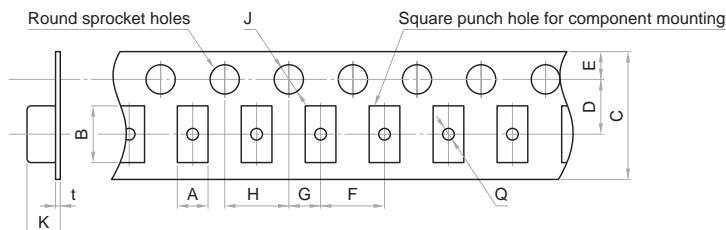

Dimensions in: mm

Type	A	B	C	D	E	F	G	H	J	K	t	Q
YFF31PC	1.90 typ.	3.50 typ.	8.0±0.3	3.5±0.05	1.75±0.1	4.00±0.1	2.0±0.05	4.00±0.1	ø1.5+0.1/-0	2.50 max.	0.30 max.	ø0.50 max.

⚠ Please be sure to request delivery specifications that provide further details on the features and specifications of the products for proper and safe use.  
Please note that the contents may change without any prior notice due to reasons such as upgrading.