

Part Number: ACDC02-41SYKWA-F01

Super Bright Yellow

Features

- 0.2 inch digit height.
- Low current operation.
- Excellent character appearance.
- Mechanically rugged.
- Package :300pcs / reel.
- Gray face, white segment.
- Moisture sensitivity level : level 2a.
- RoHS compliant.

Description

The Super Bright Yellow device is made with AlGaInP (on GaAs substrate) light emitting diode chip.

Package Dimensions & Internal Circuit Diagram

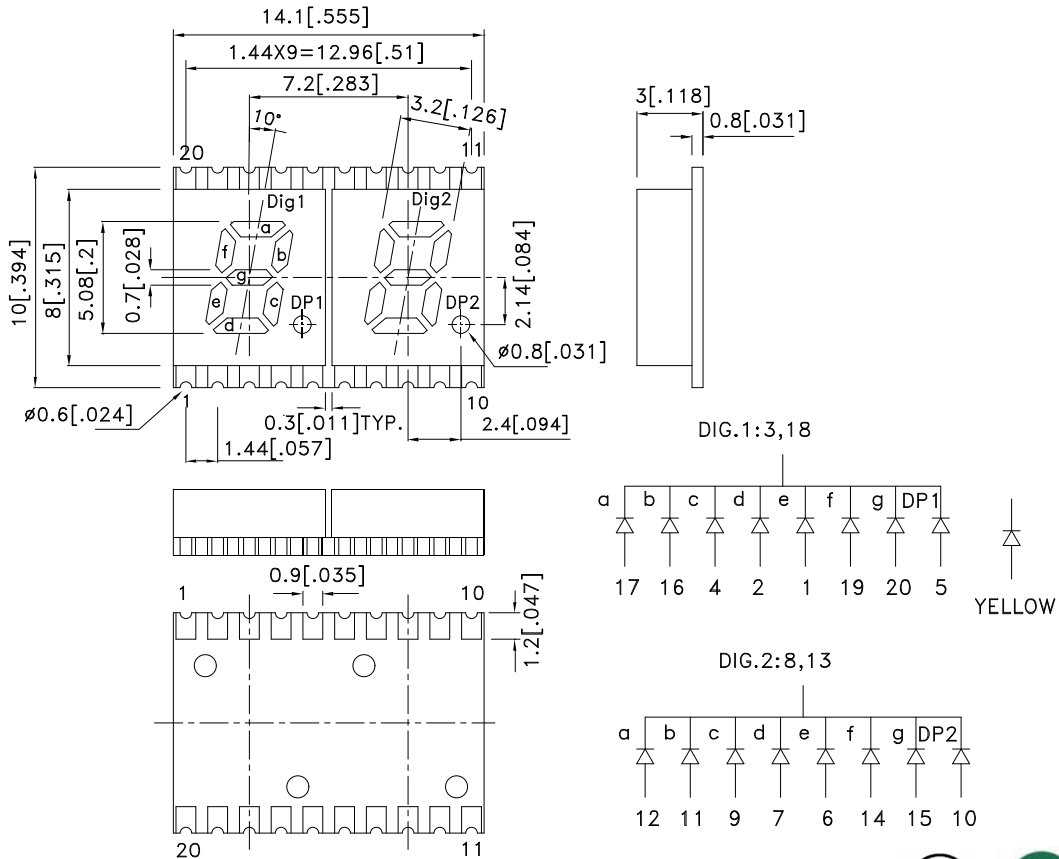

Notes:

1. All dimensions are in millimeters (inches), Tolerance is ± 0.25 (0.01") unless otherwise noted.
2. The specifications, characteristics and technical data described in the datasheet are subject to change without prior notice.
3. The gap between the reflector and PCB shall not exceed 0.25mm.



Selection Guide

Part No.	Dice	Lens Type	Iv (ucd) [1] @ 10mA		Description
			Min.	Typ.	
ACDC02-41SYKWA-F01	Super Bright Yellow (AlGaInP)	White Diffused	21000	50000	Common Cathode, Rt. Hand Decimal.

Note:

1. Luminous intensity/ luminous Flux: +/-15%.

Electrical / Optical Characteristics at TA=25°C

Symbol	Parameter	Device	Typ.	Max.	Units	Test Conditions
λ_{peak}	Peak Wavelength	Super Bright Yellow	590		nm	I _F =20mA
λ_D [1]	Dominant Wavelength	Super Bright Yellow	590		nm	I _F =20mA
$\Delta\lambda_{1/2}$	Spectral Line Half-width	Super Bright Yellow	20		nm	I _F =20mA
C	Capacitance	Super Bright Yellow	20		pF	V _F =0V;f=1MHz
V _F [2]	Forward Voltage	Super Bright Yellow	2.0	2.5	V	I _F =20mA
I _R	Reverse Current	Super Bright Yellow		10	uA	V _R =5V

Notes:

1. Wavelength: +/-1nm.

2. Forward Voltage: +/-0.1V.

Absolute Maximum Ratings at TA=25°C

Parameter	Super Bright Yellow	Units
Power dissipation	75	mW
DC Forward Current	30	mA
Peak Forward Current [1]	175	mA
Reverse Voltage	5	V
Operating / Storage Temperature	-40°C To +85°C	

Note:

1. 1/10 Duty Cycle, 0.1ms Pulse Width.

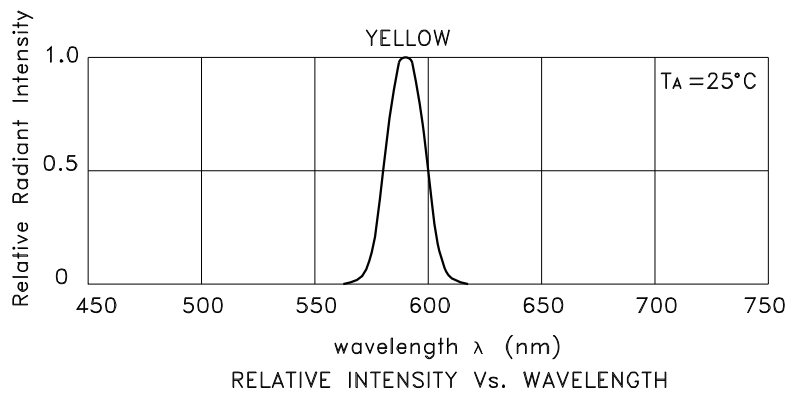

Super Bright Yellow ACDC02-41SYKWA-F01

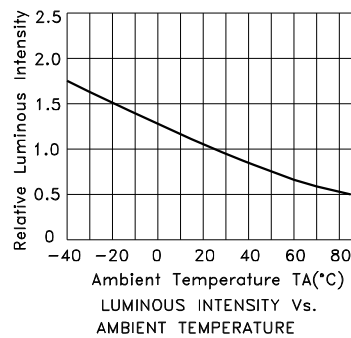
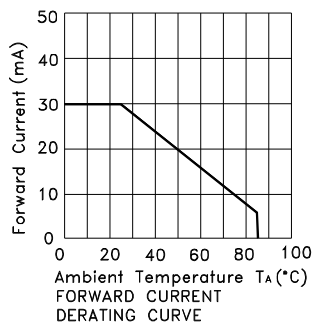
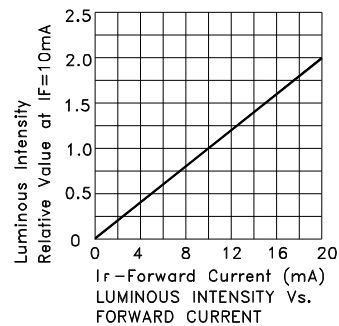
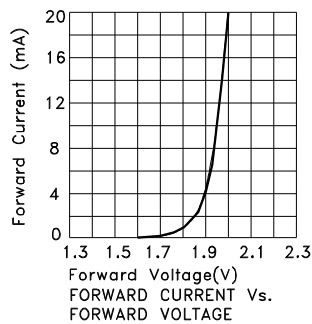

CIRCUIT DESIGN NOTES

1. Protective current-limiting resistors may be necessary to operate the Displays.
2. LEDs mounted in parallel should each be placed in series with its own current-limiting resistor.

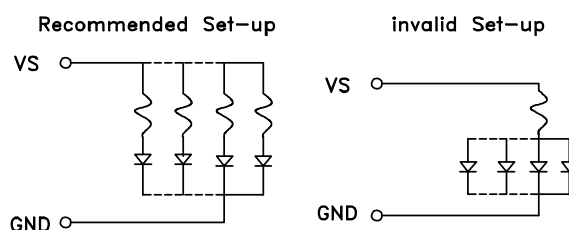

ACDC02-41SYKWA-F01

Reflow Soldering Profile For Lead-free SMT Process.

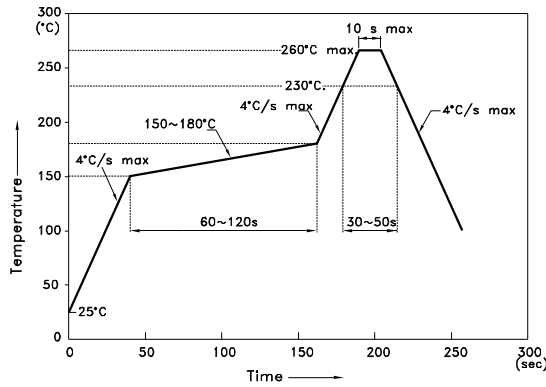

NOTES:

1. We recommend the reflow temperature 245°C(+/-5°C). The maximum soldering temperature should be limited to 260°C.
2. Don't cause stress to the epoxy resin while it is exposed to high temperature.
3. Number of reflow process shall be 2 times or less.

Recommended Soldering Pattern (Units : mm; Tolerance: ± 0.15)

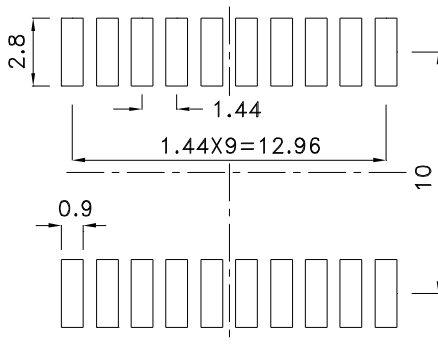

Reel Dimension

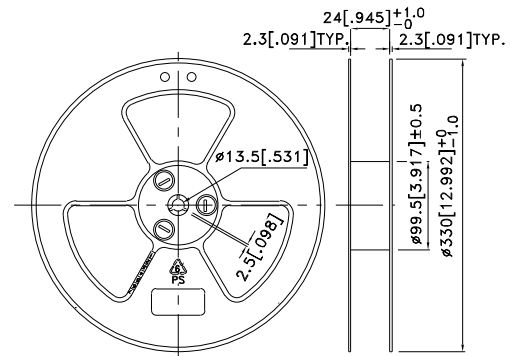

Tape Specifications (Units : mm)

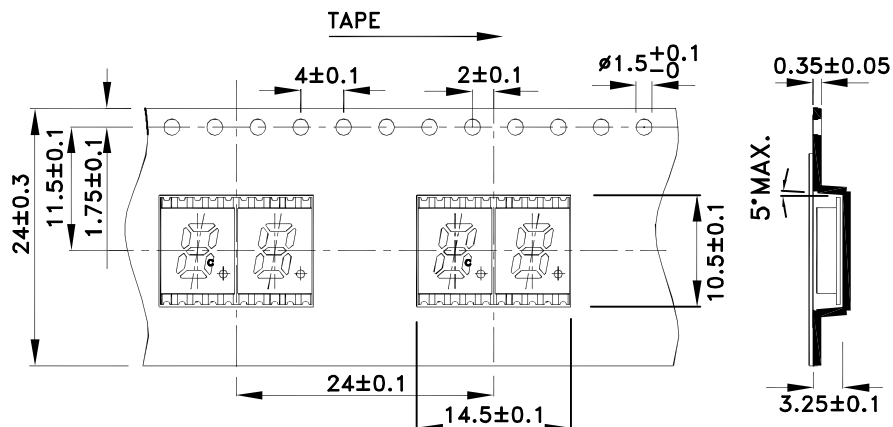

PACKING & LABEL SPECIFICATIONS

ACDC02-41SYKWA-F01

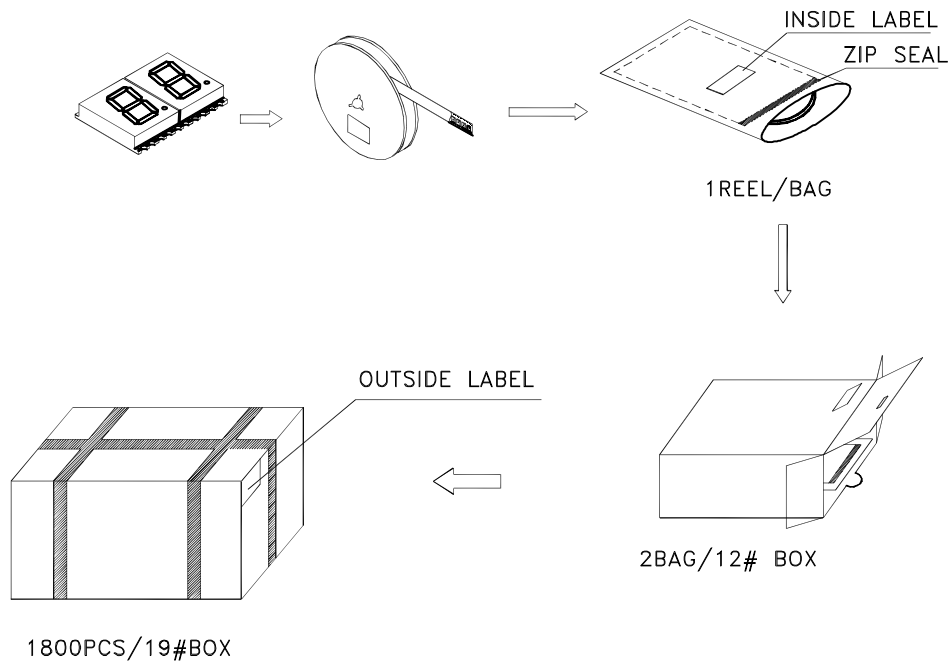

Inside Label On Tape

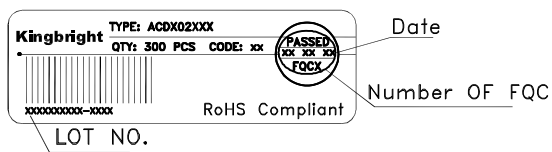

Outside Label On Bag

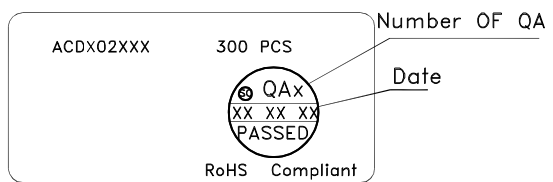

Outside Label On 19#Box

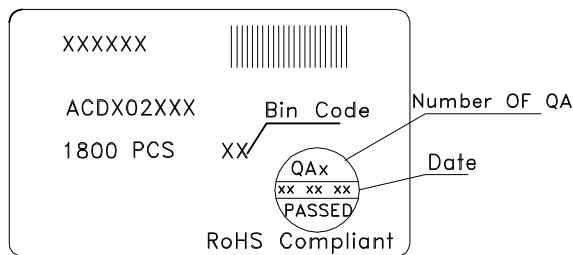

Outside Label On 12#Box

