

SX1272 Development Kit

USER GUIDE

Table of Contents

Table of Contents	2
Index of Figures	3
1 Preamble.....	4
2 Introduction	4
3 Getting Started.....	5
3.1 Evaluation Kit Contents	5
3.2 Ordering information	6
3.3 Updating the firmware	6
4 Eiger Platform Presentation	10
4.1 Platform Description	10
4.2 SX1272 Module Hardware	11
5 Eiger platform for PER Testing	12
5.1 Menu Description	12
5.2 Using the Eiger platform.....	12
5.2.1 System Window.....	13
5.2.2 PER Demo Window.....	15
5.2.3 PER Rx Bar-graph.....	23
6 SX1272SKA Software Description.....	24
6.1 SX1272SKA Quick start Guide	24
6.2 LoRa Mode.....	27
6.2.1 LoRa Menu	27
6.2.2 LoRa Common Window	28
6.2.3 LoRa Parameters Window	29
6.3 FSK Mode	30
6.3.1 FSK Menu	30
6.3.2 Common window.....	31
6.3.3 Transmitter window	32
6.3.4 Receiver window	33
6.3.5 IRQ and Map window	34
6.3.6 Packet Handler window.....	35
6.3.7 Sequencer window	36
6.3.8 Temperature window.....	37
7 How to.....	38
7.1 ... perform a simple transmission / reception in LoRa	38
7.2 ... perform a simple transmission / reception in FSK.....	40
7.3 ... perform Continuous transmission and Reception in LoRa	44
7.4 ... Log the Transmitted or Received packets.....	45
7.5 ... perform a CW or PN9 Tx test on the SX1272	46
7.6 ... check the frequency accuracy of the SX1272 module	46
8 Troubleshooting	47
8.1 The Eiger platform indicates very high PER even in short range	47
8.2 The communication range in Lora is very poor	47
8.3 The SX1272SKA do not detect the device through the USB.....	47
8.4 The Eiger platform does not seem to work anymore	47
8.5 The Eiger platform touch screen is not accurate	47

Index of Figures

Figure 1: SX1272 Development Kit (SX1272DVK1BAS - 868MHz version)	5
Figure 2: Eiger platform description	10
Figure 3: Sx1272 Module Schematic	11
Figure 4: Connect both USB ports to use the SX1272SKA	24
Figure 5: SX1272 window organization	25
Figure 6: Register table	26
Figure 7: SX1272SKA Boot-up windows	28
Figure 8: LoRa Radio parameters window	29
Figure 9: FSK window structure	30
Figure 10: FSK Common window	31
Figure 11: FSK Transmitter window	32
Figure 12: FSK Receiver window	33
Figure 13: FSK IRQ and Map window	34
Figure 14: FSK Packet Handler window	35
Figure 15: FSK Sequencer window	36
Figure 16: FSK Temperature window	37

1 Preamble

This document describes how to use the SX1272 Evaluation kit. This document describes especially the SX1272 Eiger platform and the SX1272 SKA User Interface. We strongly recommend for the user to read thoroughly the datasheet of the SX1272 prior to start working on the device. Most of this document assumes a general knowledge on the SX1272 and modern RF communications.

2 Introduction

The SX1272 is a single-chip integrated circuit ideally suited for today's high performance ISM band RF applications. Added to the renowned, high-performance and low-cost, FSK / OOK RF transceiver modem, the SX1272 is also equipped with the LoRa proprietary transceiver modem. This advanced feature set, including a state of the art packet engine, greatly simplifies system design whilst the high level of integration reduces the external BOM to a handful of passive decoupling and matching components. It is intended for use as high-performance, long range, half-duplex bi-directional RF links, and where stable and constant RF performances are required over the full operating range of the device down to 1.8V.

The SX1272 is intended for applications over a wide frequency range, including the 868 MHz European and the 902-928 MHz North American ISM bands. Coupled with a link budget in excess of 135 dB in FSK in excess of 155 dB in LoRa, the SX1272 really offers the possibility of two modems in one single package. The SX1272 complies with both ETSI and FCC regulatory requirements and is available in a 5x5 mm QFN 28 lead free package.

The SX1272 Evaluation kit, based around the Eiger platform, allows the user to test every aspect of the radio, both from the system and RF point of view.

On one hand, the Eiger platform is a touch screen portable device which has been design to enable quick and easy testing of the PER performances of the SX1272. On the other hand, the SX1272SKA is a PC based evaluation tool which allows in depth testing of the radio.

This document is therefore divided in two parts: the first part present the SX1272 Eiger module and how to perform PER test in LoRa and FSK; the second part of this document present the SX1272 SKA and how it can be used to test every single aspect of the radio.

3 Getting Started

3.1 Evaluation Kit Contents

The SX1272SKA evaluation kit consists of:

- 2 x Eiger platforms
- 2 x SX1272 modules
- 2 x ½ wave dipole antennas
- 2 x Mini-USB cables
- Insert sheet



Figure 1: SX1272 Development Kit (SX1272DVK1BAS - 868MHz version)

3.2 Ordering information

Each of part of the SX1272 Evaluation kit can be ordered as a single entity or in a whole package. When ordering, please refer to the following parts numbers:

SX1272DVK1BAS	SX1272 Development Kit (868MHz version)
SX1272DVK1CAS	SX1272 Development Kit (915MHz version)
SX1272RF1BAS	SX1272 Evaluation Module (868MHz version + antenna)
SX1272RF1CAS	SX1272 Evaluation Module (915MHz version + antenna)

For more information on each of the options available, please, contact your local Semtech representative. The SX1272SKA evaluation software, the firmware, drivers and all SX1272 related materials are available on the Semtech website: <http://www.semtech.com/wireless-rf/rf-transceivers/>

3.3 Updating the firmware

Updating the Eiger platform firmware is straight forward given that the user follows some simple steps. The first step is to install the Eiger platform drivers on the PC used to update the firmware. These drivers, called RLink USB drivers are located in the folder RLinkDrv given with every version of the firmware. To install the driver, simply launch the file RLinkUSBInstall.exe.

Once the RLink drivers are installed, the firmware upgrade is done through the update.bat file which will upload the correct version of the firmware depending on several options related to the Eiger platform or module being used. When launching the application, the following window opens:

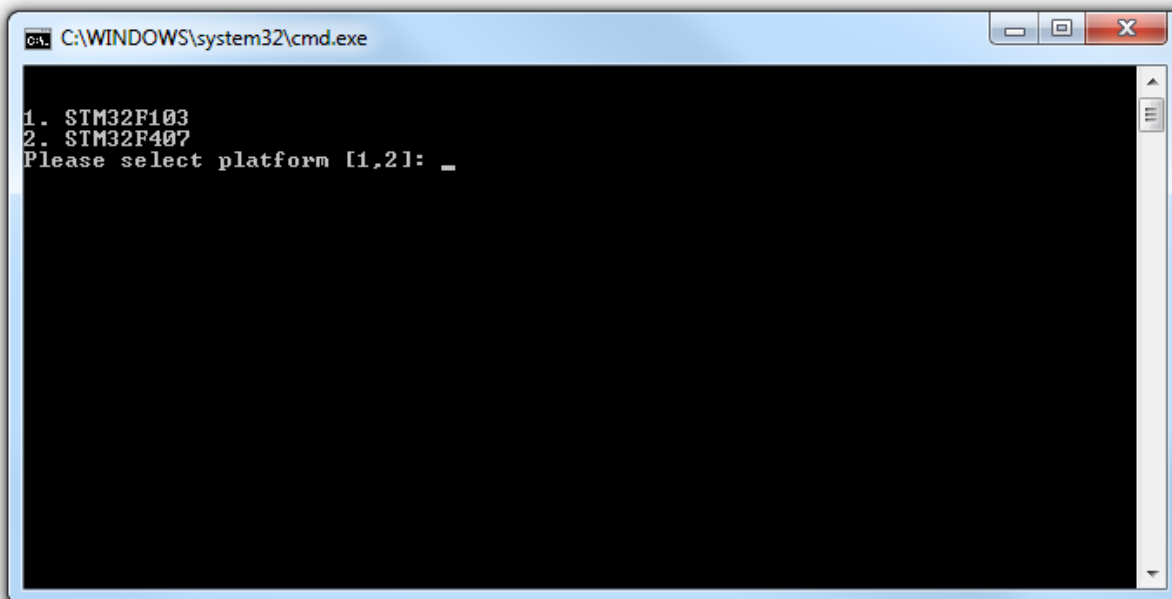

WIRELESS & SENSING PRODUCTS

This window invites the user to select the STM32 daughter board fitted on the Eiger platform. The pictures below should help the user to recognize which daughter board is which. Added to this, the STM32F407 daughter board is equipped with a small camera clearly visible at the back of the module.



STM32F103 Module



STM32F407 Module

The upgrader then needs to know which version of the SX1272 is used with the Eiger platform. Most users should have the Version 2 of the device. In case of doubt, please contact your Semtech representative.

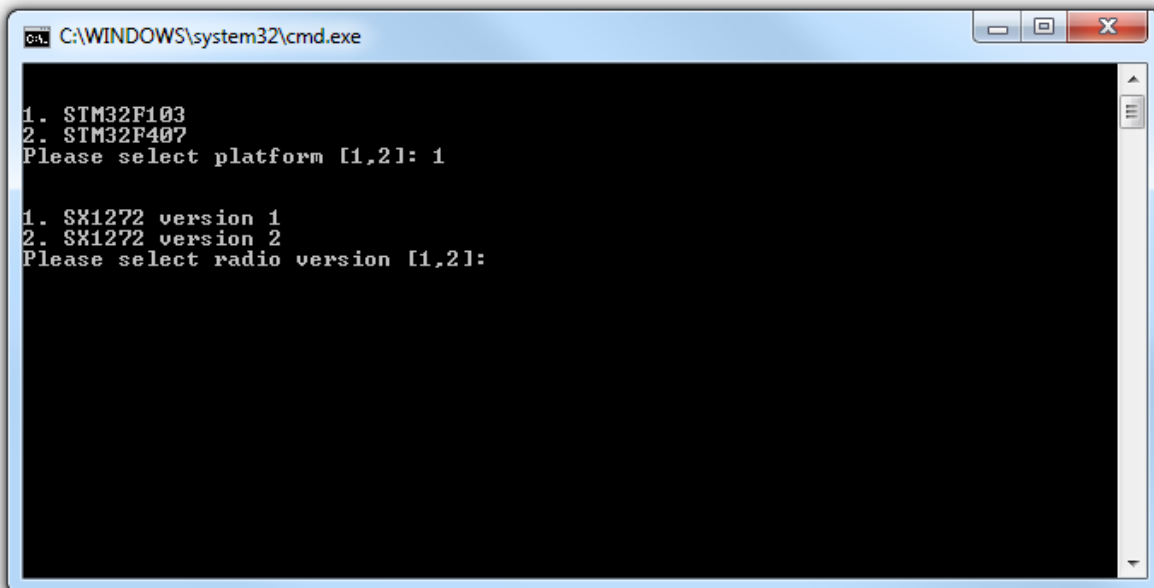

```
C:\WINDOWS\system32\cmd.exe

1. STM32F103
2. STM32F407
Please select platform [1,2]: 1

1. SX1272 version 1
2. SX1272 version 2
Please select radio version [1,2]:
```

If the Eiger platform is not powered up, is wrongly connected or if the RLink drivers are not installed, the following message will be displayed on the screen:

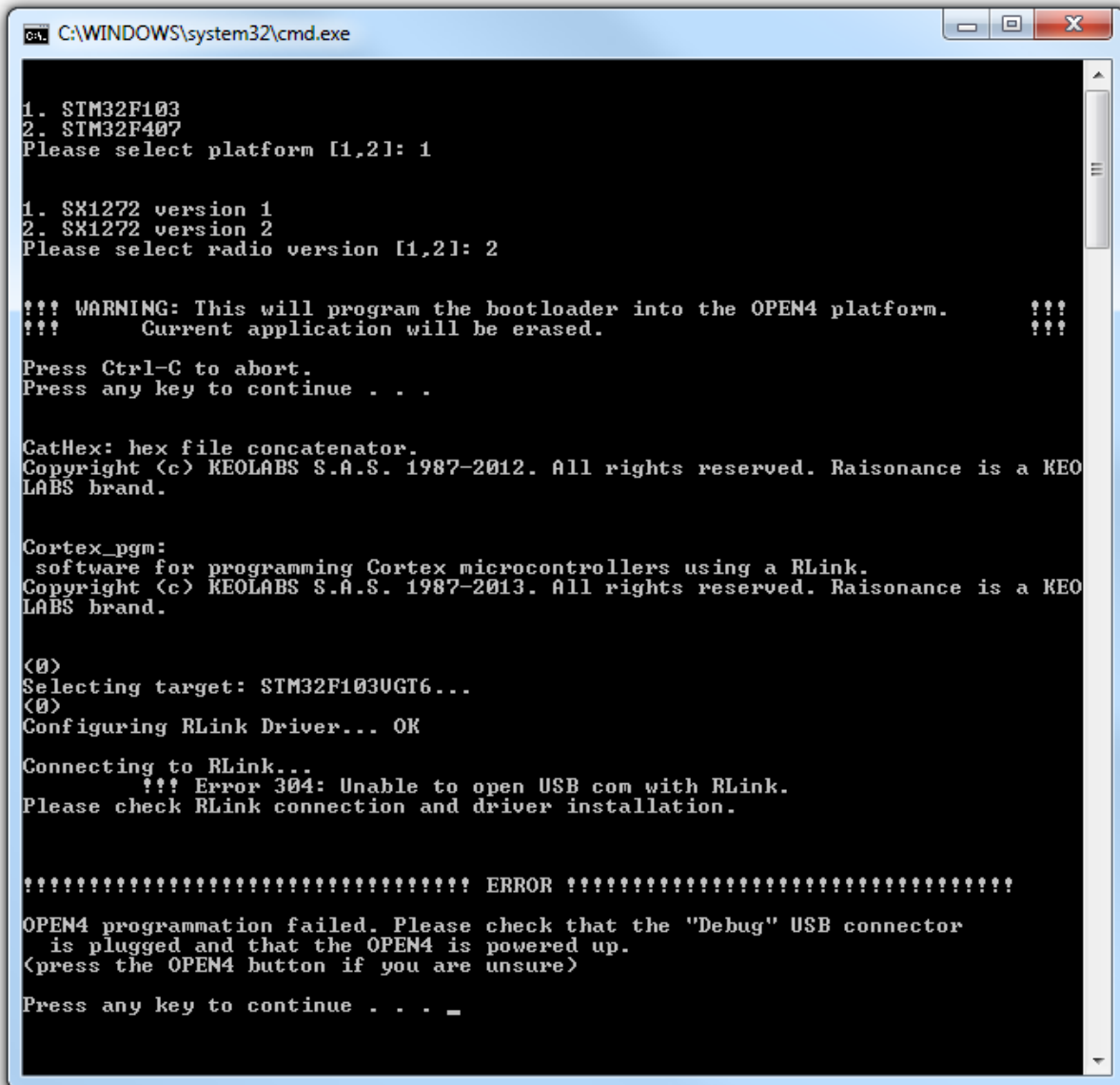

```
C:\WINDOWS\system32\cmd.exe

1. STM32F103
2. STM32F407
Please select platform [1,2]: 1

1. SX1272 version 1
2. SX1272 version 2
Please select radio version [1,2]: 2

!!! WARNING: This will program the bootloader into the OPEN4 platform.      !!!
!!!          Current application will be erased.                            !!!

Press Ctrl-C to abort.
Press any key to continue . . .

CatHex: hex file concatenator.
Copyright (c) KEOLABS S.A.S. 1987-2012. All rights reserved. Raisonance is a KEO
LABS brand.

Cortex_pgm:
software for programming Cortex microcontrollers using a RLink.
Copyright (c) KEOLABS S.A.S. 1987-2013. All rights reserved. Raisonance is a KEO
LABS brand.

<0>
Selecting target: STM32F103UGT6...
<0>
Configuring RLink Driver... OK

Connecting to RLink...
!!! Error 304: Unable to open USB com with RLink.
Please check RLink connection and driver installation.

!!!!!!!!!!!!!!!!!!!!!!!!!!!!!!!!!!!!!!!!!!!!!!!!!!!!!!!!!!!!!!!!!!!!!!!!!!!!!!!!!!!!!!!!!!!!!!!!!!!!!!!!!!!!!!!!!!!!!!!!
OPEN4 programmation failed. Please check that the "Debug" USB connector
is plugged and that the OPEN4 is powered up.
<press the OPEN4 button if you are unsure>

Press any key to continue . . . _
```

In this situation, the user need to make sure the device is correctly powered and turned on. Please, refer to section 4.1 of this document for more information.

This is what the full upgrader should look like at the end of the software update.

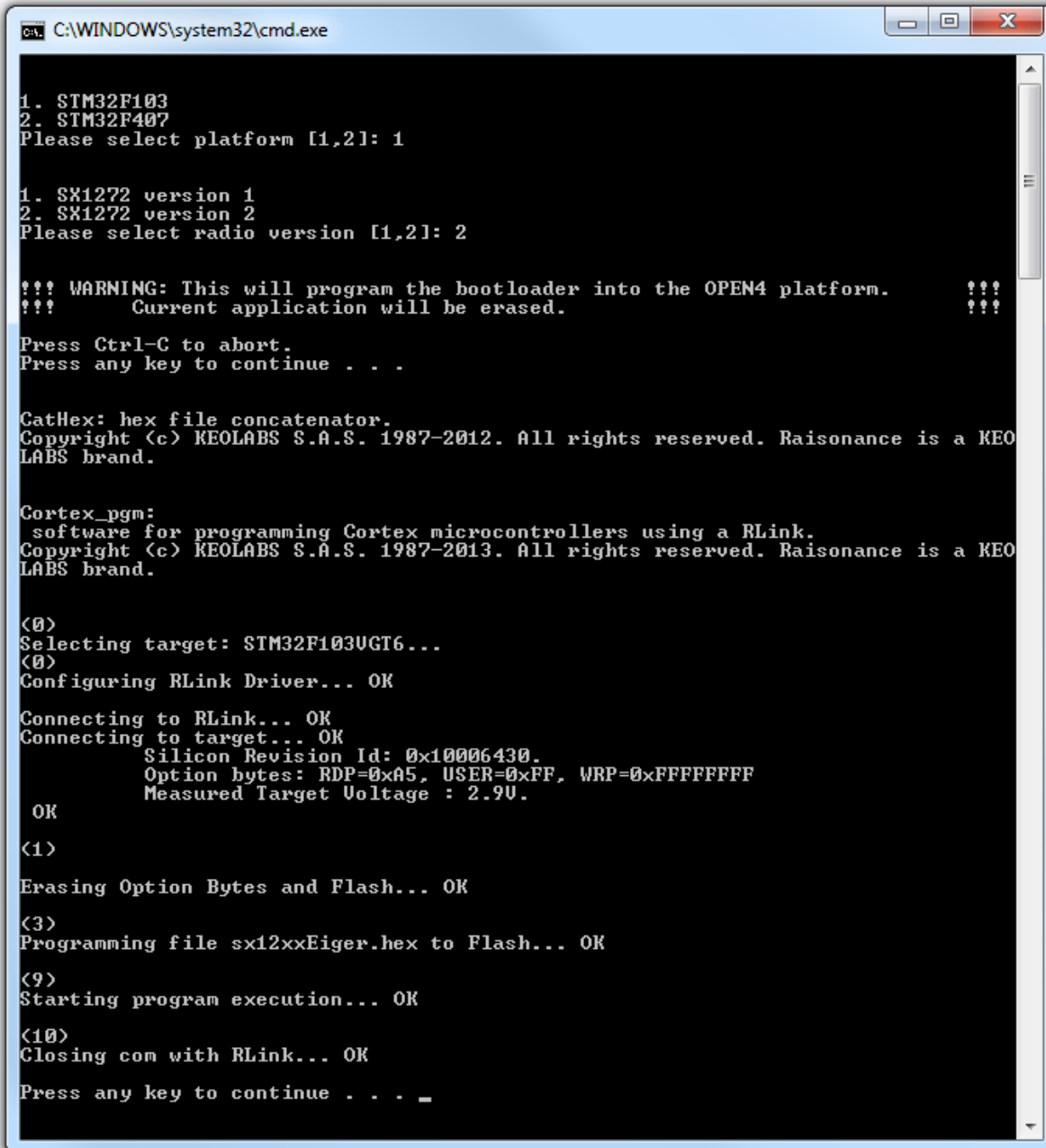

```
C:\WINDOWS\system32\cmd.exe

1. SIM32F103
2. SIM32F407
Please select platform [1,2]: 1

1. SX1272 version 1
2. SX1272 version 2
Please select radio version [1,2]: 2

!!! WARNING: This will program the bootloader into the OPEN4 platform.    !!!
!!!      Current application will be erased.                               !!!

Press Ctrl-C to abort.
Press any key to continue . . .

CatHex: hex file concatenator.
Copyright (c) KEOLABS S.A.S. 1987-2012. All rights reserved. Raisonance is a KEOLABS brand.

Cortex_pgm:
software for programming Cortex microcontrollers using a RLink.
Copyright (c) KEOLABS S.A.S. 1987-2013. All rights reserved. Raisonance is a KEOLABS brand.

<0>
Selecting target: SIM32F103UGT6...
<0>
Configuring RLink Driver... OK

Connecting to RLink... OK
Connecting to target... OK
      Silicon Revision Id: 0x10006430.
      Option bytes: RDP=0xA5, USER=0xFF, WRP=0xFFFFFFFF
      Measured Target Voltage : 2.90.

OK

<1>
Erasing Option Bytes and Flash... OK

<3>
Programming file sx12xxEiger.hex to Flash... OK

<9>
Starting program execution... OK

<10>
Closing com with RLink... OK

Press any key to continue . . . _
```

Once the software has been upgraded, it is recommended to reset all the internal settings on the Eiger platform. For more information on how to achieve this, please, refer to section 5.2.1.1 of this document.

4 Eiger Platform Presentation

4.1 Platform Description

The Eiger platform is intended to enable a quick and easy range test of the sx1272 module. Here most of the modem parameters are pre-configured and the user only needs to set some RF parameters.

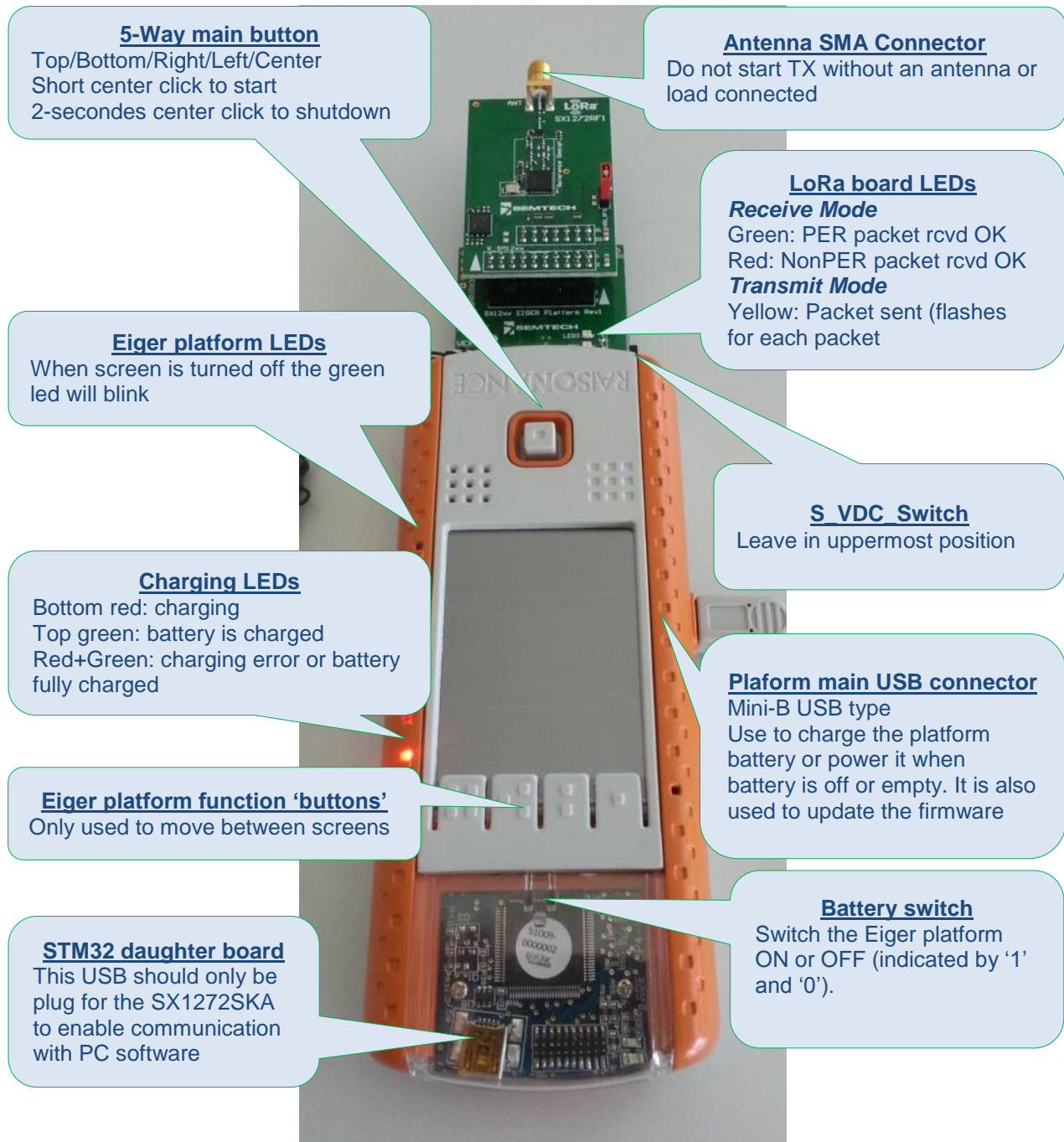

Figure 2: Eiger platform description

4.2 SX1272 Module Hardware

The SX1272SKA is a USB based evaluation software designed to allow simple and easy evaluation of the suitability of the SX1272 for a given application. The low component count reference design implemented in the SX1272RF1xAS reference board is illustrated below in Figure 3.

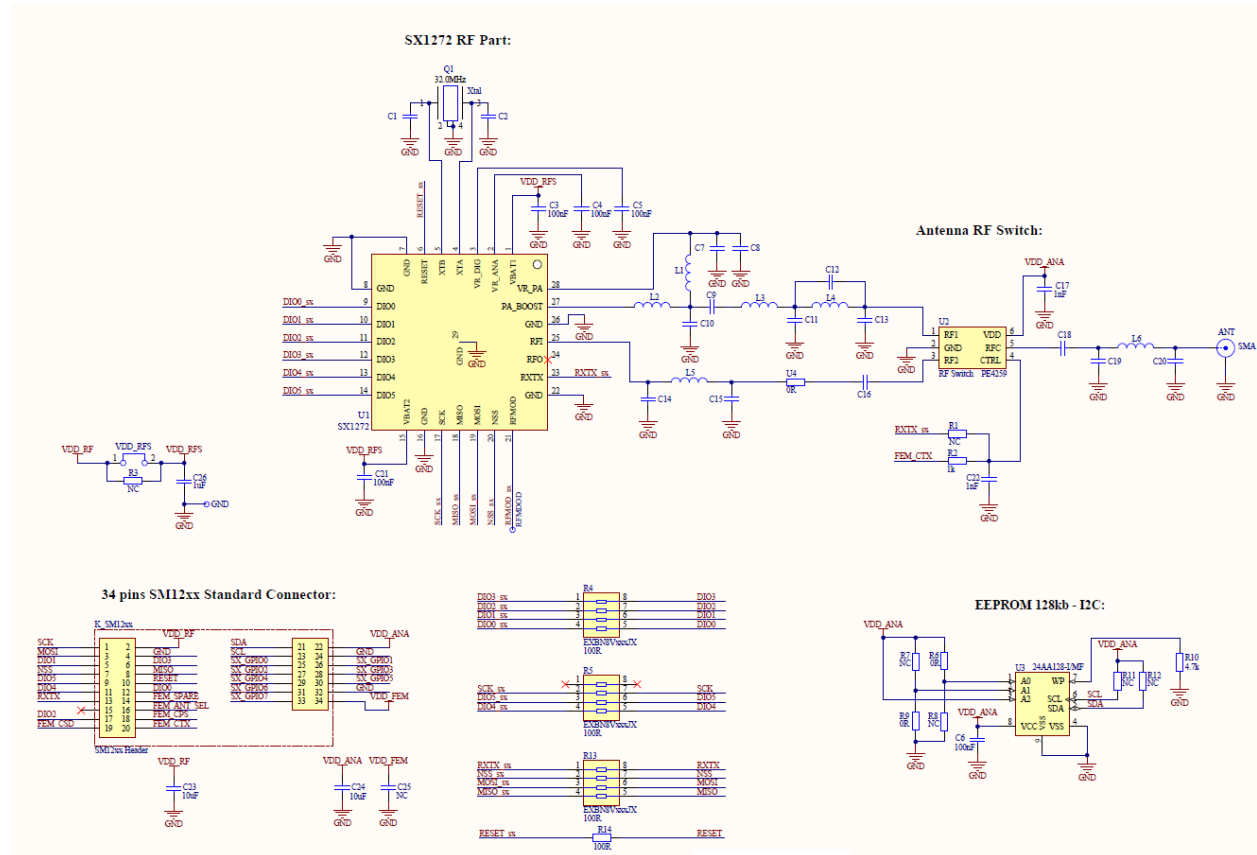

Figure 3: Sx1272 Module Schematic

The circuit has been specifically match to offer the best performances in the 860-930MHz range.

5 Eiger platform for PER Testing

5.1 Menu Description

The Eiger menu is organized around the touch screen which allows the user to set on the fly a limited number of parameters. We will here describe each menu window so that the user can quickly start doing PER testing.

The idea behind the PER demo is to set one of the Eiger platform as a transmitter and the other one as a receiver. Then both platforms can be moved away one from the other, in an urban or in an open field environment, to easily capture the PER between the transmitter and the receiver.

The PER demo operates in FSK or in LoRa modes so that the advantages and drawbacks of each modulation can be seen easily.

5.2 Using the Eiger platform

The home screen is the first window displayed on the control touch screen.

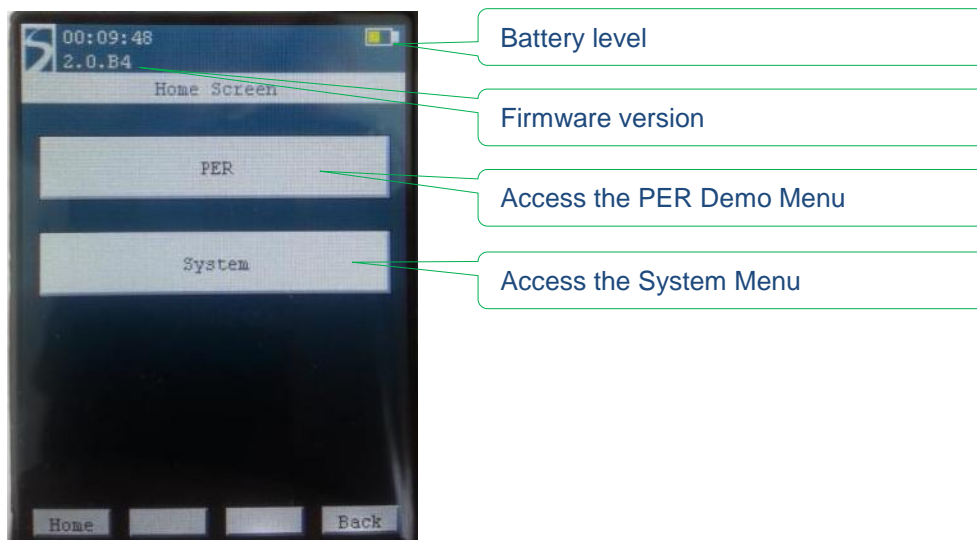

5.2.1 System Window

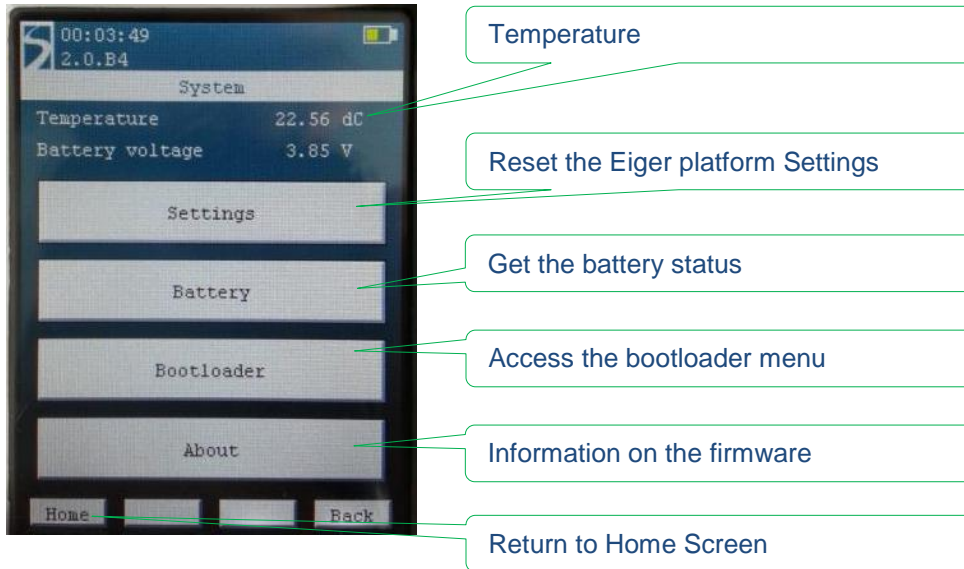

5.2.1.1 Settings

In case of miss-operation or to simply reset the Eiger module into a known state, it is possible the reset the touch screen parameters or to reset the device parameters to their default parameters.

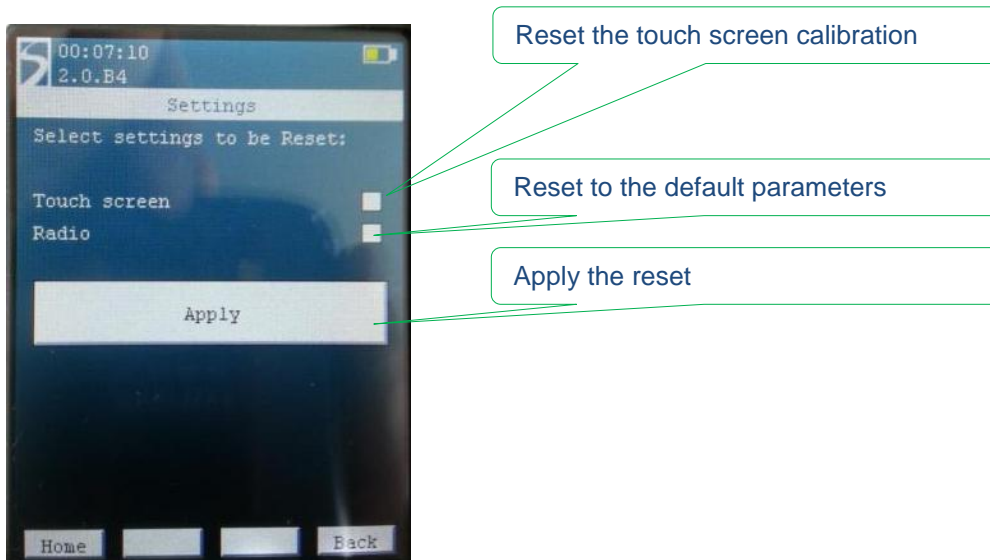

Once a box is ticked, “clicking” on the Apply button will reset the selected parameters. The ticked box will then go un-ticked.

5.2.1.2 Battery



Indicates the battery state

Indicates the battery level

Indicates the voltage delivered by the battery

5.2.1.3 Bootloader

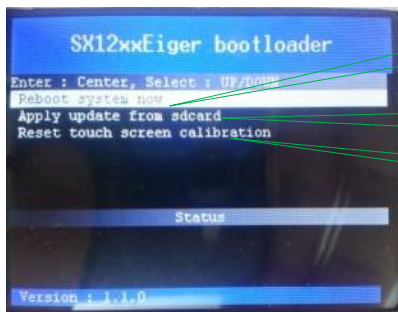

Reboot the system

Update the firmware through an SD card

Reset touch screen calibration

5.2.1.4 About

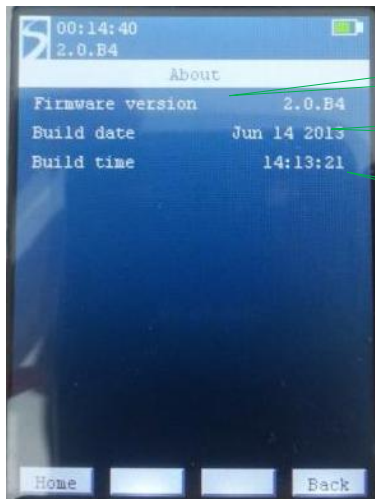

Indicates the Firmware version

Indicates the Build date

Indicates the Build time

5.2.2 PER Demo Window

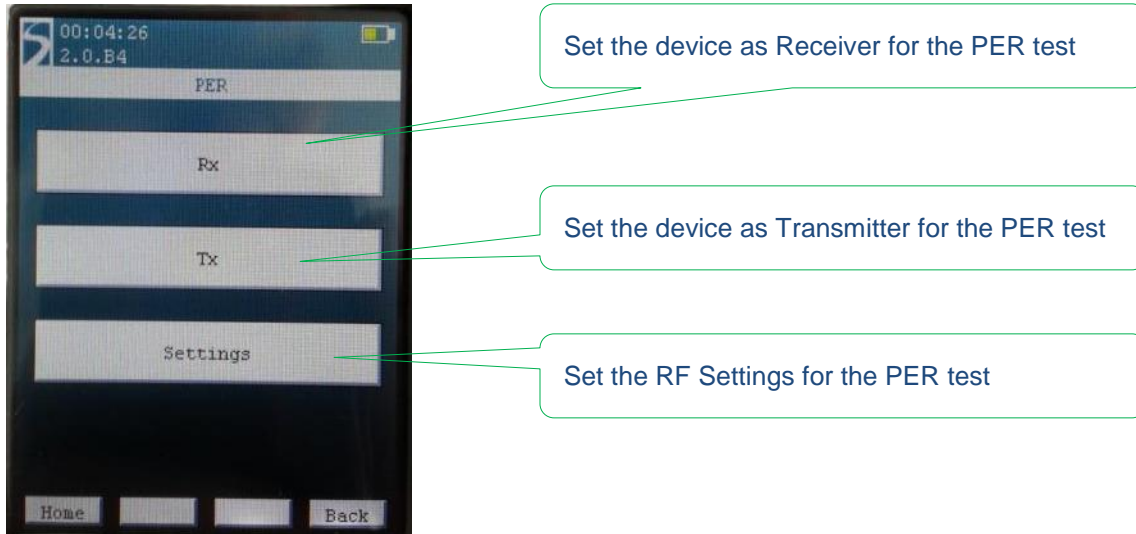

The PER Demo menu is the core of the Eiger platform testing. The menu is divided in three main areas, Tx, Rx and Settings. The PER Settings menu allows the user to set several parameters of the Radio for Tx and Rx.

A text in green indicates that the value can be changed. For example, on the first window of the PER Setting screen, you will see:

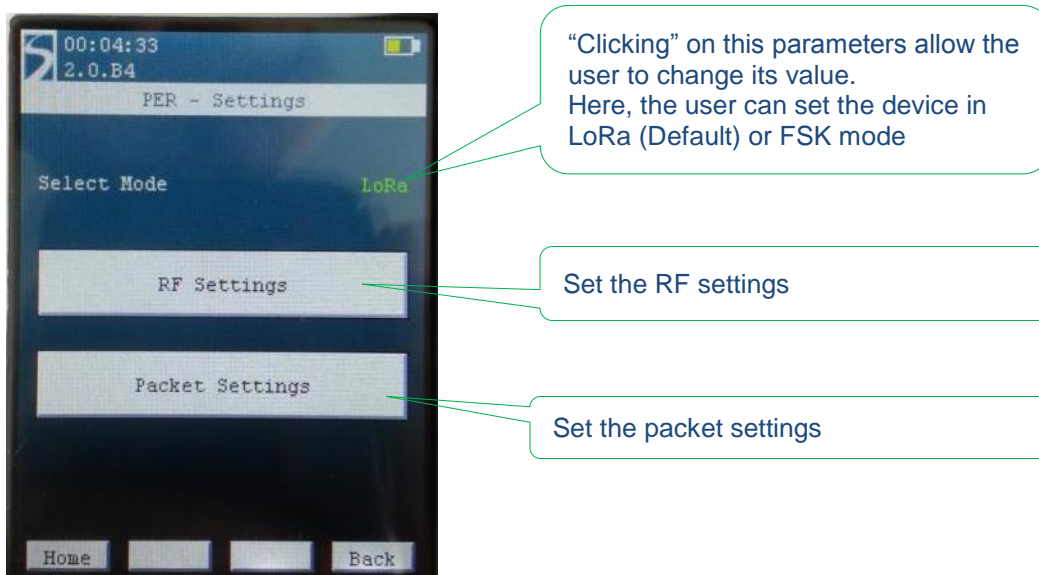

5.2.2.1 PER Settings Menu running in FSK mode

For a given modulation, there is only a limited set of parameters that can be set by the user. Most of the parameters are set automatically in the software to keep the interface user friendly.

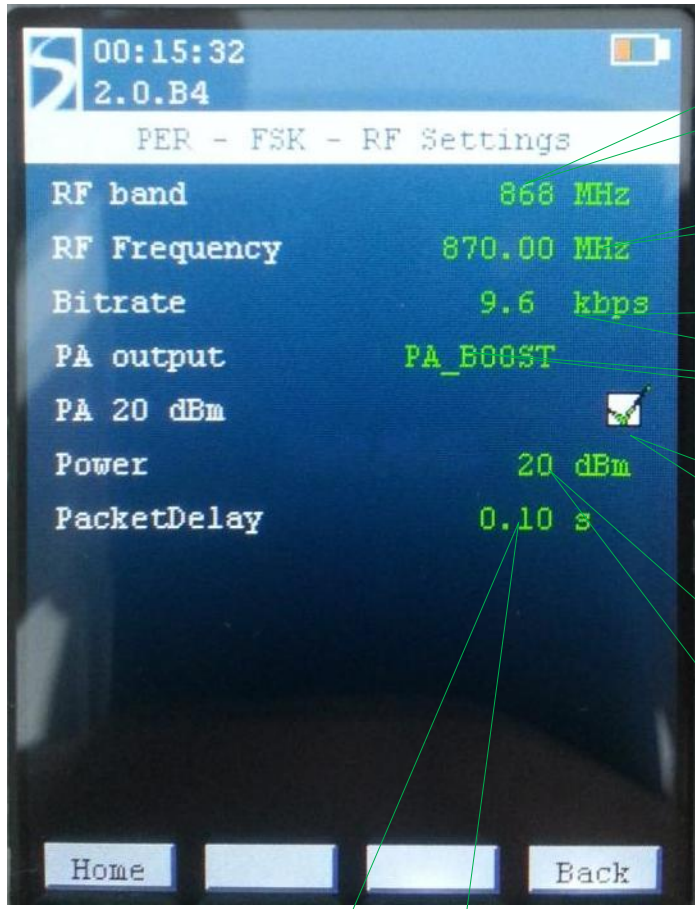

The screenshot shows the 'PER - FSK - RF Settings' menu with the following parameters and values:

- RF band: 868 MHz
- RF Frequency: 870.00 MHz
- Bitrate: 9.6 kbps
- PA output: PA_BOOST
- PA 20 dBm:
- Power: 20 dBm
- PacketDelay: 0.10 s

Callouts provide the following instructions for each parameter:

- Set the RF Band (868MHz or 915MHz)
- Set the RF frequency (within the band)
- Set the Bitrate: 4.8kbps, 9.6kbps, 19.2kbps, 38.4kbps, 57.6kbps or 100kbps
- Set the RF output (module dependent)
- Set the Output Power boost
- Set the RF output power
- Set the inter-packet delay

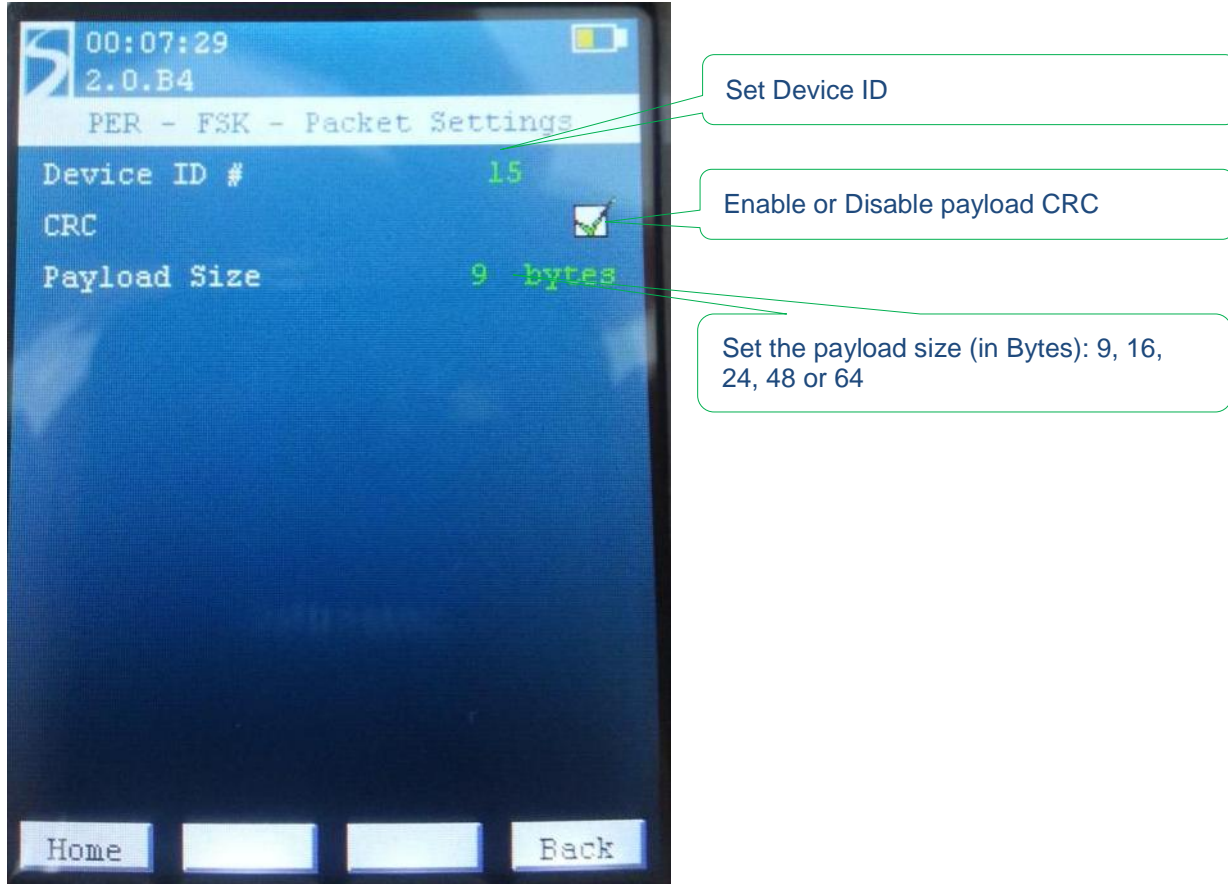
5.2.2.2 PER Packet Settings Menu running in FSK mode

In FSK mode, the payload is built in the following way:

Preamble (8 Bytes)	SyncWord (0x69-0x81-0x7E-0x96)	Payload length (1 Byte)	Payload (Platform ID, 32-bit packet cnt, 'P', 'E', 'R', FCS, 'Padding [xx Bytes]')	CRC (2 Bytes)
-----------------------	-----------------------------------	-------------------------------	---	------------------

The preamble length, the SyncWord and the basic payload structure cannot be changed by the user. However, the payload length is adjustable and the 'Padding' field will increase or decrease depending of the payload size. The CRC can also be enabled or disabled from the packet settings menu. All in all the smallest packet will be 22 bytes long and the longest packet will be 78 bytes long in total.

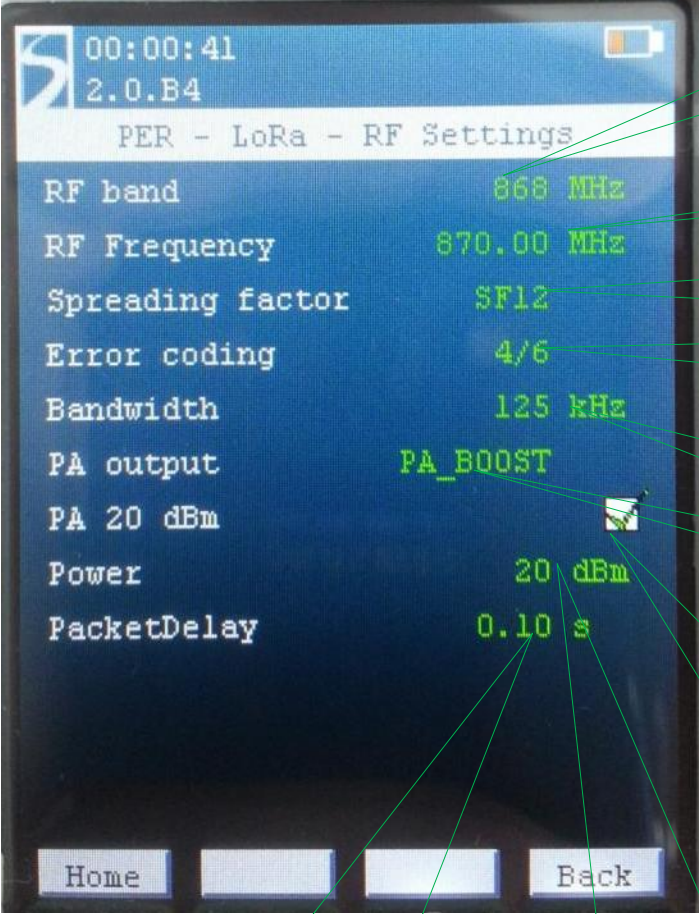
5.2.2.3 PER Settings Menu running in LoRa mode

The screenshot shows the 'PER - LoRa - RF Settings' menu with the following parameters and values:

- RF band: 868 MHz
- RF Frequency: 870.00 MHz
- Spreading factor: SF12
- Error coding: 4/6
- Bandwidth: 125 kHz
- PA output: PA_BOOST
- PA 20 dBm:
- Power: 20 dBm
- PacketDelay: 0.10 s

Callouts provide the following instructions for each parameter:

- Set the RF Band (868MHz or 915MHz)
- Set the RF frequency (within the band)
- Set the Spreading factor: 6, 7, 8, 9, 10, 11 or 12
- Set the Error Coding: 4/5, 4/6, 4/7, 4/8
- Set the Bandwidth: 125KHz, 250KHz or 500KHz
- Set the RF output (module dependent)
- Set the Output Power boost
- Set the inter-packet delay
- Set the RF output power

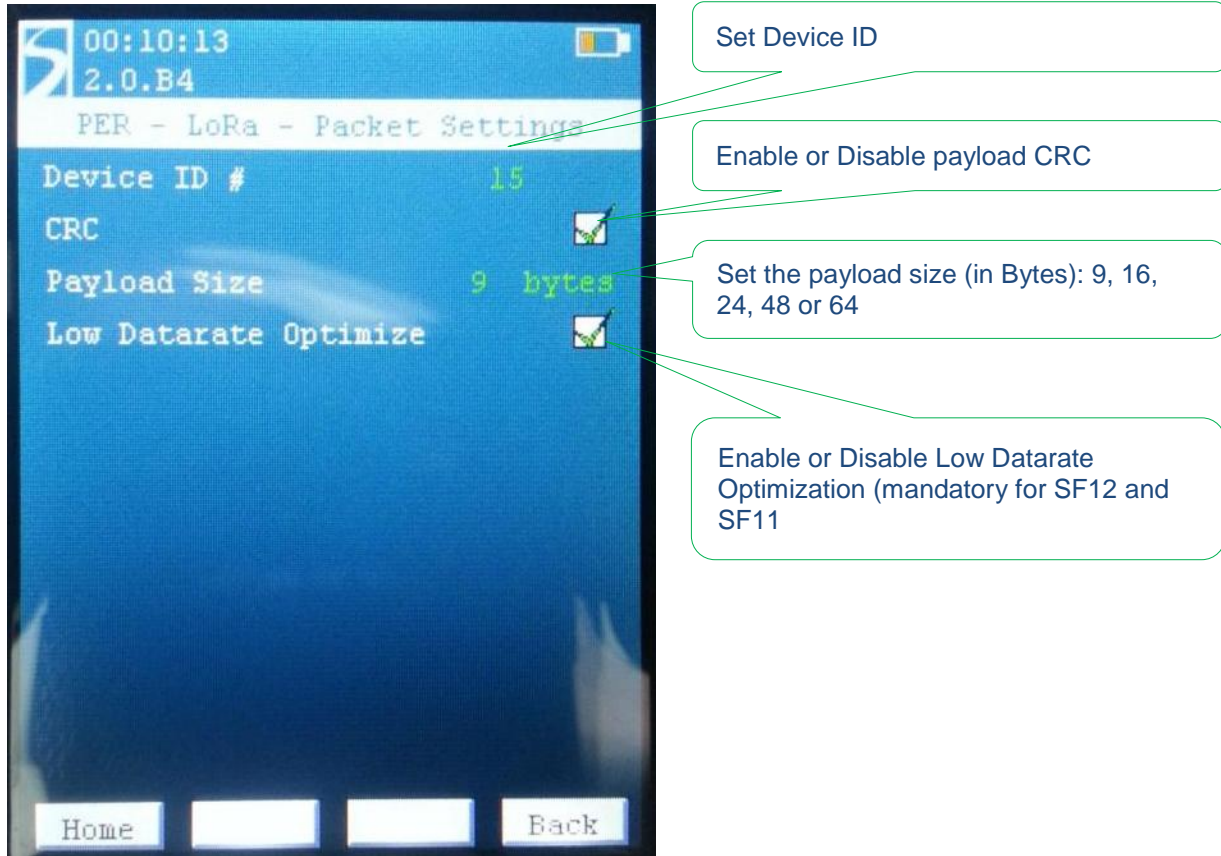
5.2.2.4 PER Packet Settings Menu running in LoRa mode

In LoRa mode, the payload is built in the following way:

Preamble (8 Symb.)	Header (8 Symb.)	Payload (Platform ID, 32-bit packet cnt, 'P', 'E', 'R', FCS, 'Padding [xx Bytes]')	CRC (2 Bytes)
-----------------------	---------------------	---	------------------

The preamble length, the Header and the basic payload structure cannot be changed by the user. However, the payload length is adjustable and the 'Padding' field will increase or decrease depending of the payload size. The CRC can also be enabled or disabled from the packet settings menu.

5.2.2.5 PER TX Mode

Once the RF parameters are set, putting the Eiger module in TX mode will initiate the packet transmission. The TX window displays the RF parameters and the number of packet sent since the beginning of the test.

PER Tx window in Lora mode:

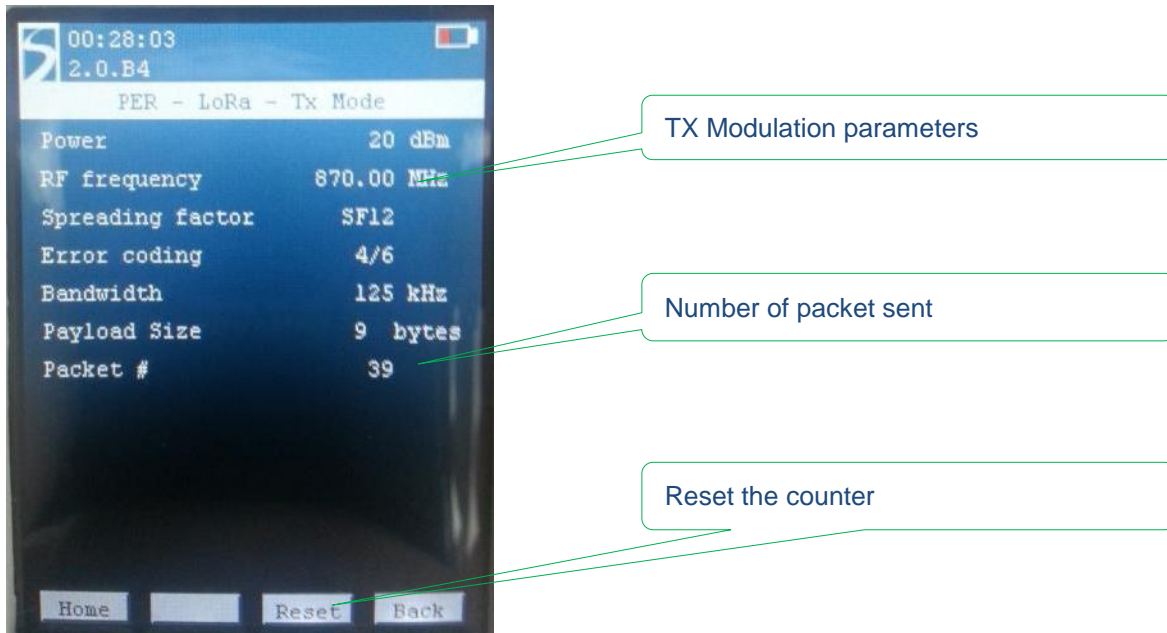

PER Tx window in FSK mode:

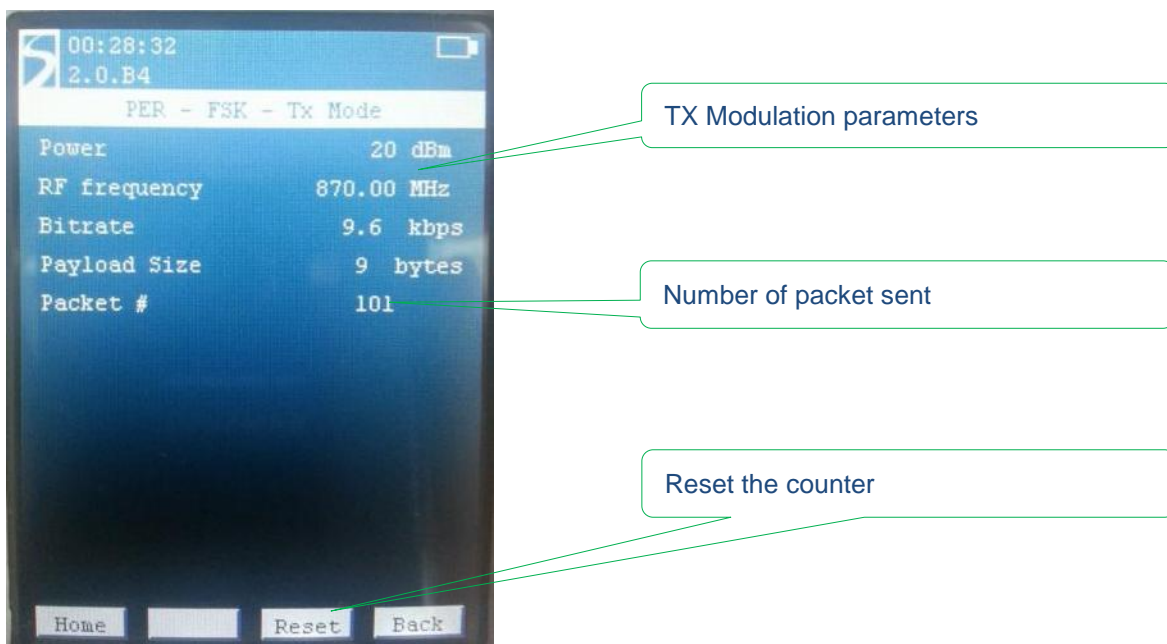

5.2.2.6 PER RX Mode

PER Rx window in Lora mode:

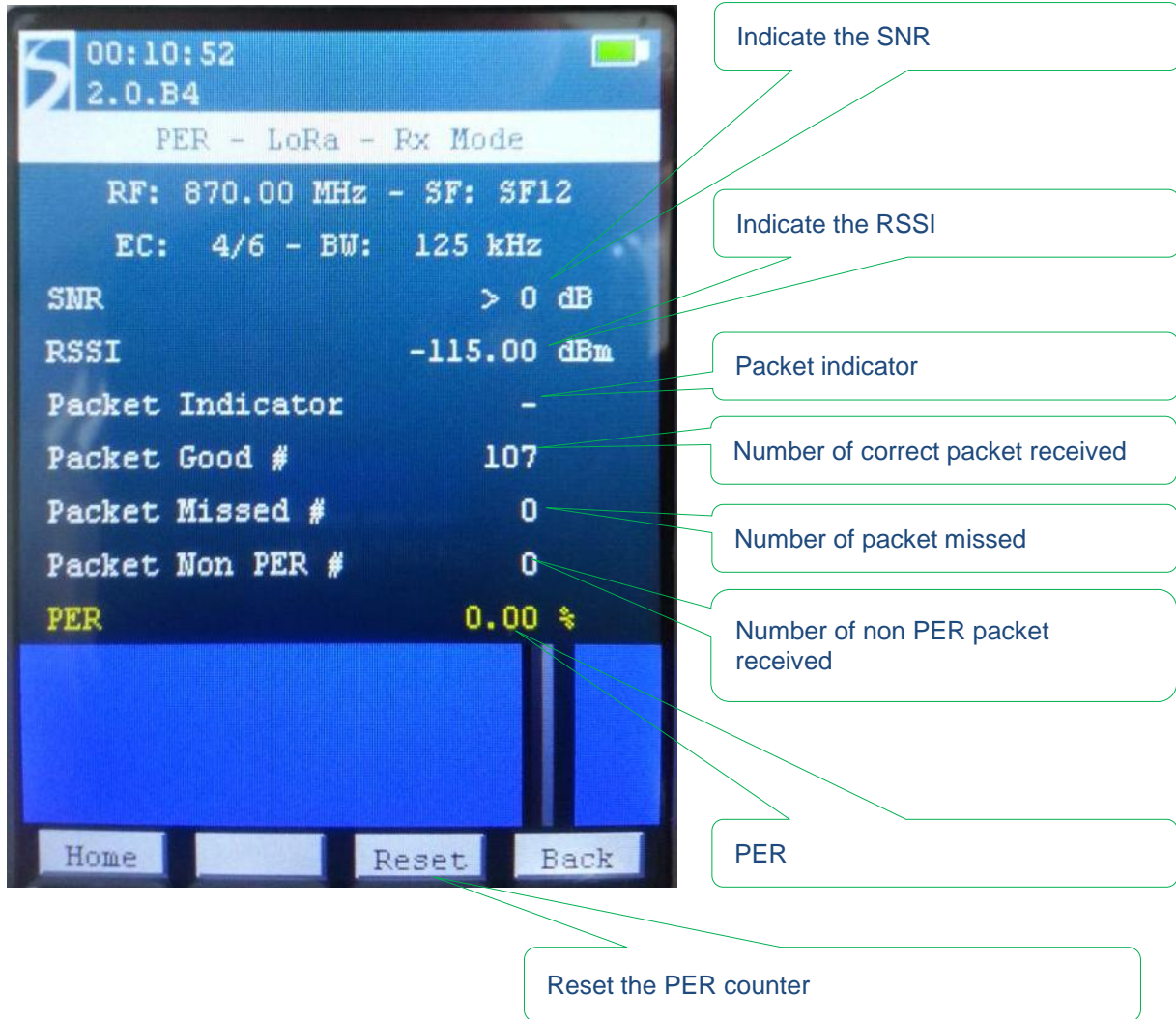

The screenshot shows the following data on the screen:

- 00:10:52 (Time)
- 2.0.B4 (Version)
- PER - LoRa - Rx Mode (Title)
- RF: 870.00 MHz - SF: SF12 (Frequency and Spreading Factor)
- EC: 4/6 - BW: 125 kHz (Error Correction and Bandwidth)
- SNR > 0 dB (Signal-to-Noise Ratio)
- RSSI -115.00 dBm (Received Signal Strength Indicator)
- Packet Indicator - (Indicator)
- Packet Good # 107 (Number of correct packets received)
- Packet Missed # 0 (Number of missed packets)
- Packet Non PER # 0 (Number of non-PER packets received)
- PER 0.00 % (Packet Error Rate)

Callouts from the image:

- Indicate the SNR
- Indicate the RSSI
- Packet indicator
- Number of correct packet received
- Number of packet missed
- Number of non PER packet received
- PER
- Reset the PER counter

In LoRa mode, when sub-noise reception is occurring (SNR < 0), the displayed RSSI value is extrapolated using the SNR indicator. When the SNR > 0, the actual SNR is not computed and the value is clamped.

WIRELESS & SENSING PRODUCTS

PER Rx window in FSK mode:

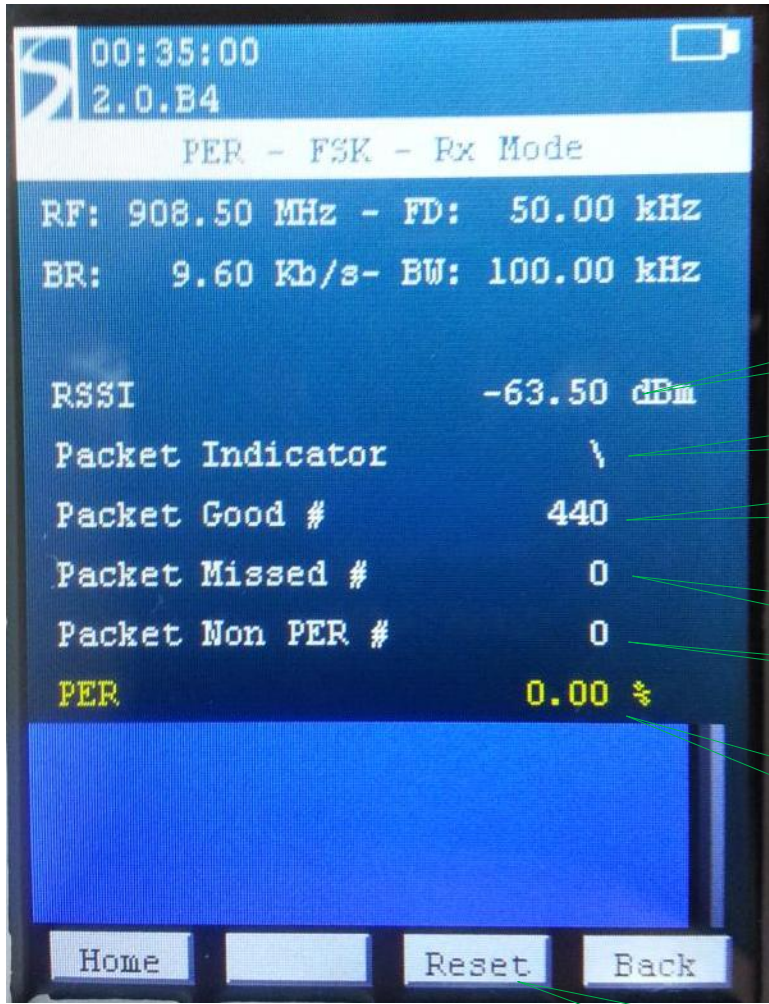

00:35:00
2.0.B4

PER - FSK - Rx Mode

RF: 908.50 MHz - FD: 50.00 kHz
BR: 9.60 Kb/s - BW: 100.00 kHz

RSSI -63.50 dBm

Packet Indicator \

Packet Good # 440

Packet Missed # 0

Packet Non PER # 0

PER 0.00 %

Home Reset Back

Indicate the RSSI

Packet indicator

Number of correct packet received

Number of packet missed

Number of non PER packet received

PER

Reset the PER counter

5.2.3 PER Rx Bar-graph

In Rx mode, a bar-graph indicates the distribution of the error over time. This is especially useful to detect the cause of the error, whether a burst of noise in the frequency band or if the device is in the limit of reception range. The examples below highlight what each case looks like:

Here, the device is at the limit of the reception range

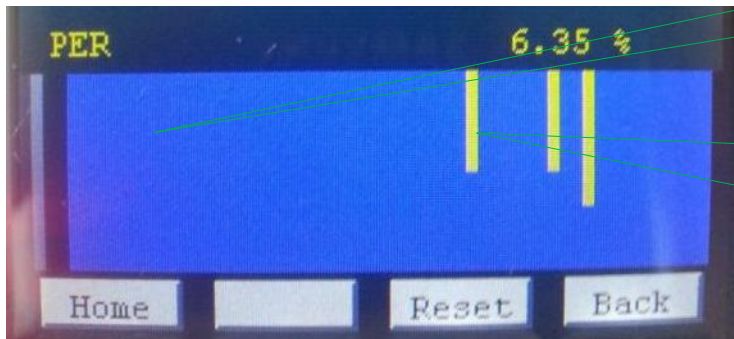

Blue: the reception is good and we are receiving every packet sent

Yellow: We have some disturbance in the frequency band or we are arriving at the limit range of reception and we start missing packets.

As we can see in the picture below, the device lost many packets in a short amount of time.



Yellow: We have had a strong burst of noise in the band and we have missed most of the packet during a small amount of time

The link has improved and we are only missing a few packets after the original noise burst.

6 SX1272SKA Software Description

The SX1272SKA is organized on a PC software GUI communicating through USB with the Eiger platforms. In this situation, the Eiger platforms are only used as a gateway to communicate with the SX1272.

6.1 SX1272SKA Quick start Guide

It is recommended that this user guide is read in conjunction with the SX1272 datasheet.

1. Plug the Eiger Platform USB ports to the computer (one USB is used to power the platform while the other USB is used for communication).
2. Run the SX1272 User Interface software: Start > All Programs > SX1272SKA > SX1272SKA
3. The SX1272SKA should connect automatically to the User Interface Software. If not, click on the USB connect button, located in the top left hand corner of the window toolbar.
4. Once connected the SX1272SKA shows the default configuration of the SX1272 register settings upon power-up. If the EVK is not connected, the GUI screen is grayed out and an error message is displayed in the bottom left hand corner of the status bar.

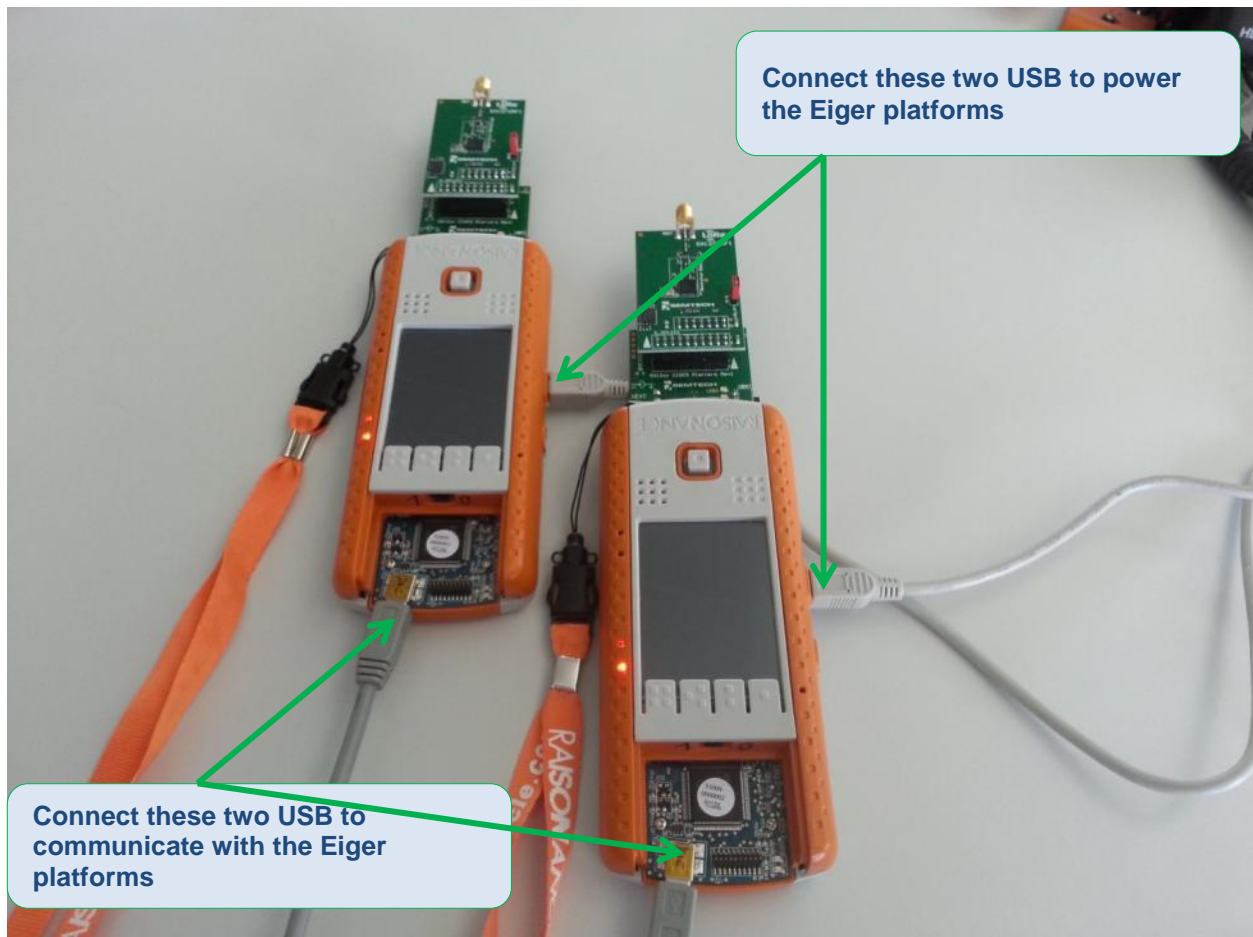

Figure 4: Connect both USB ports to use the SX1272SKA

WIRELESS & SENSING PRODUCTS

The SX1272SKA has been developed to test all the capabilities and features of the FSK and LoRa modems present in the device. However, both modems have different control commands and must be operated independently.

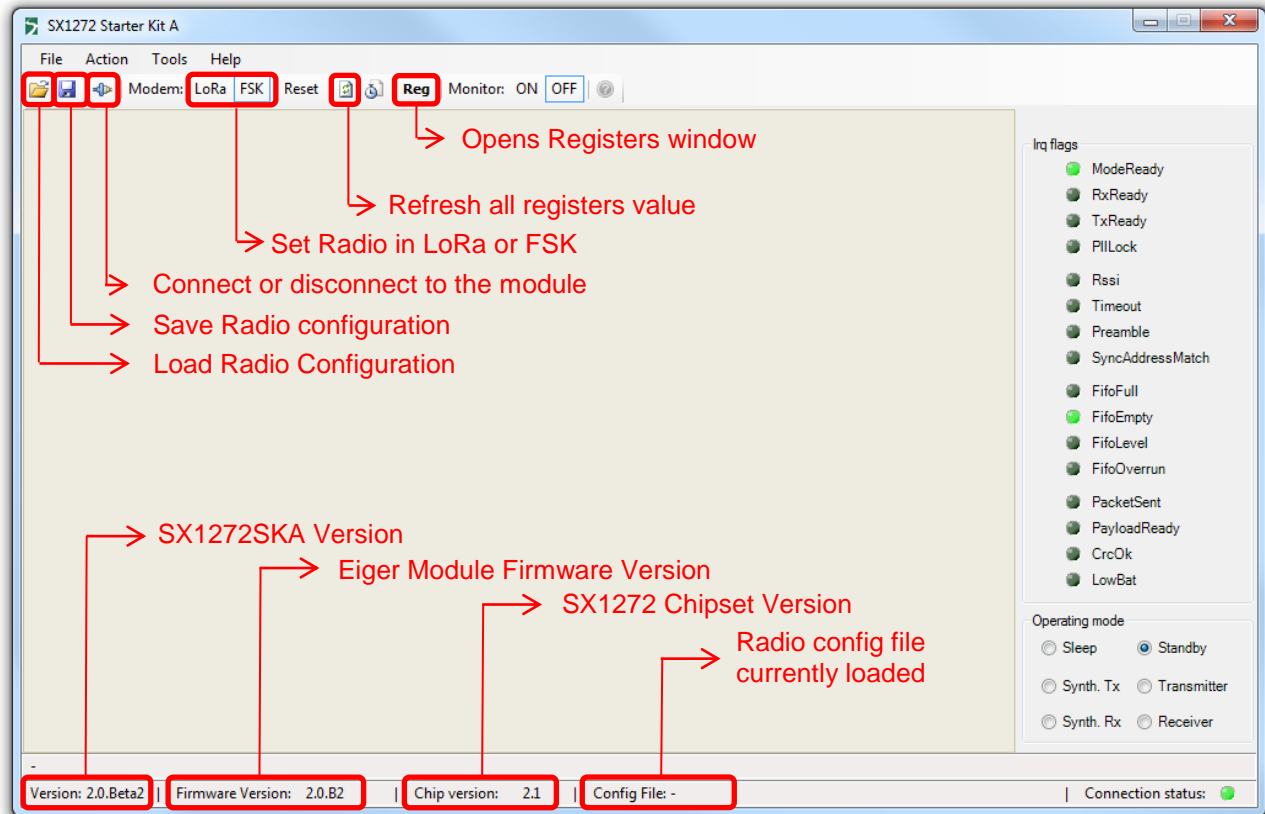

Figure 5: SX1272 window organization

While this approach has limitation on testing the system capability of the device, it allows the user to thoroughly evaluate the device from the radio point of view

This chapter is presenting the various windows and field that controls the radio operations. While some controls can be obvious, some others may need the user to refer to the datasheet to get a full description of the commands.

A load radio configuration is implemented and allows the opening of SX1272SKA configuration files (.cfg). This is implemented through a standard Windows file dialog box and may also be accessed through the short cut buttons of the Window Toolbar.

In the same way, it is possible to save the SX1272SKA configuration files (.cfg). This is implemented through a standard Windows file dialog box. The default file name is the last configuration file saved.

For reference purposes, it is possible to display the register map of the device. This can help the user to refer to the datasheet register when testing the device.

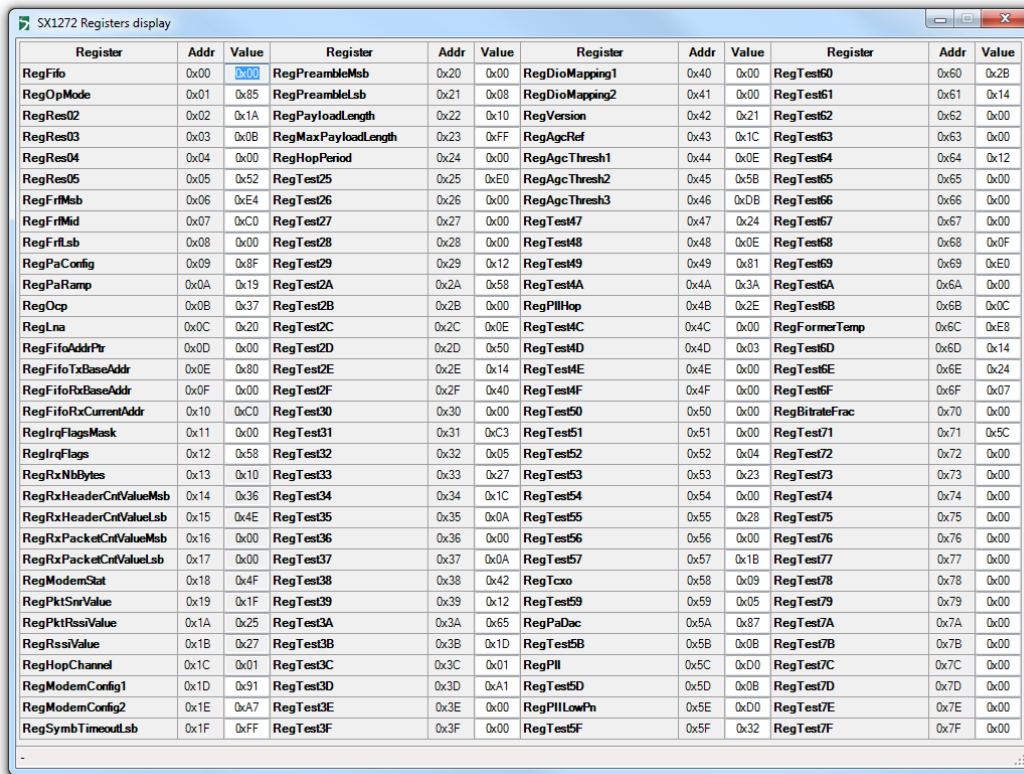

Register	Addr	Value	Register	Addr	Value	Register	Addr	Value	Register	Addr	Value
RegFifo	0x00	0x00	RegPreambleMsb	0x20	0x00	RegDioMapping1	0x40	0x00	RegTest60	0x60	0x2B
RegOpMode	0x01	0x85	RegPreambleLsb	0x21	0x08	RegDioMapping2	0x41	0x00	RegTest61	0x61	0x14
RegRes02	0x02	0x1A	RegPayloadLength	0x22	0x10	RegVersion	0x42	0x21	RegTest62	0x62	0x00
RegRes03	0x03	0x0B	RegMaxPayloadLength	0x23	0xFF	RegAgcRef	0x43	0x1C	RegTest63	0x63	0x00
RegRes04	0x04	0x00	RegHopPeriod	0x24	0x00	RegAgcThresh1	0x44	0x0E	RegTest64	0x64	0x12
RegRes05	0x05	0x52	RegTest25	0x25	0xE0	RegAgcThresh2	0x45	0x5B	RegTest65	0x65	0x00
RegFrfMsb	0x06	0xE4	RegTest26	0x26	0x00	RegAgcThresh3	0x46	0xDB	RegTest66	0x66	0x00
RegFrfMid	0x07	0xC0	RegTest27	0x27	0x00	RegTest47	0x47	0x24	RegTest67	0x67	0x00
RegFrfLsb	0x08	0x00	RegTest28	0x28	0x00	RegTest48	0x48	0x0E	RegTest68	0x68	0x0F
RegPaConfig	0x09	0x8F	RegTest29	0x29	0x12	RegTest49	0x49	0x81	RegTest69	0x69	0xE0
RegPaRamp	0x0A	0x19	RegTest2A	0x2A	0x58	RegTest4A	0x4A	0x3A	RegTest6A	0x6A	0x00
RegOcp	0x0B	0x37	RegTest2B	0x2B	0x00	RegPllHop	0x4B	0x2E	RegTest6B	0x6B	0x0C
RegLna	0x0C	0x20	RegTest2C	0x2C	0x0E	RegTest4C	0x4C	0x00	RegFormerTemp	0x6C	0xE8
RegFifoAddrPtr	0x0D	0x00	RegTest2D	0x2D	0x50	RegTest4D	0x4D	0x03	RegTest6D	0x6D	0x14
RegFifoTxBaseAddr	0x0E	0x80	RegTest2E	0x2E	0x14	RegTest4E	0x4E	0x00	RegTest6E	0x6E	0x24
RegFifoRxBaseAddr	0x0F	0x00	RegTest2F	0x2F	0x40	RegTest4F	0x4F	0x00	RegTest6F	0x6F	0x07
RegFifoRxCurrentAddr	0x10	0xC0	RegTest30	0x30	0x00	RegTest50	0x50	0x00	RegBitrateFrac	0x70	0x00
RegIrfFlagsMask	0x11	0x00	RegTest31	0x31	0xC3	RegTest51	0x51	0x00	RegTest71	0x71	0x5C
RegIrfFlags	0x12	0x58	RegTest32	0x32	0x05	RegTest52	0x52	0x04	RegTest72	0x72	0x00
RegRxBbBytes	0x13	0x10	RegTest33	0x33	0x27	RegTest53	0x53	0x23	RegTest73	0x73	0x00
RegRxHeaderCntValueMsb	0x14	0x36	RegTest34	0x34	0x1C	RegTest54	0x54	0x00	RegTest74	0x74	0x00
RegRxHeaderCntValueLsb	0x15	0x4E	RegTest35	0x35	0x0A	RegTest55	0x55	0x28	RegTest75	0x75	0x00
RegRxPacketCntValueMsb	0x16	0x00	RegTest36	0x36	0x00	RegTest56	0x56	0x00	RegTest76	0x76	0x00
RegRxPacketCntValueLsb	0x17	0x00	RegTest37	0x37	0x0A	RegTest57	0x57	0x1B	RegTest77	0x77	0x00
RegModemStat	0x18	0x4F	RegTest38	0x38	0x42	RegTcxo	0x58	0x09	RegTest78	0x78	0x00
RegPktSnrValue	0x19	0x1F	RegTest39	0x39	0x12	RegTest59	0x59	0x05	RegTest79	0x79	0x00
RegPktRssiValue	0x1A	0x25	RegTest3A	0x3A	0x65	RegPaDac	0x5A	0x87	RegTest7A	0x7A	0x00
RegRssiValue	0x1B	0x27	RegTest3B	0x3B	0x1D	RegTest5B	0x5B	0x0B	RegTest7B	0x7B	0x00
RegHopChannel	0x1C	0x01	RegTest3C	0x3C	0x01	RegPll	0x5C	0xD0	RegTest7C	0x7C	0x00
RegModemConfig1	0x1D	0x31	RegTest3D	0x3D	0xA1	RegTest5D	0x5D	0x0B	RegTest7D	0x7D	0x00
RegModemConfig2	0x1E	0xA7	RegTest3E	0x3E	0x00	RegPllLowPn	0x5E	0xD0	RegTest7E	0x7E	0x00
RegSymbTimeoutLsb	0x1F	0xFF	RegTest3F	0x3F	0x00	RegTest5F	0x5F	0x32	RegTest7F	0x7F	0x00

Figure 6: Register table

For advance user only, it is also possible to read or write the register directly by pressing the <CTRL>+<ALT>+<T> keys of the PC keyboard simultaneously.

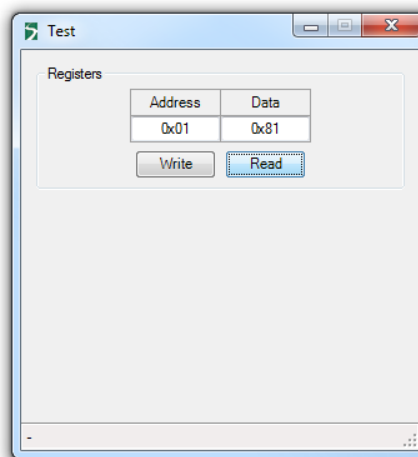

This window allows the user to write to and read from the contents of individual configuration register addresses. Note that address and data are entered in hexadecimal format.

6.2 LoRa Mode

6.2.1 LoRa Menu

By default, when the application is launched, the SX1272SKA is configured in LoRa.

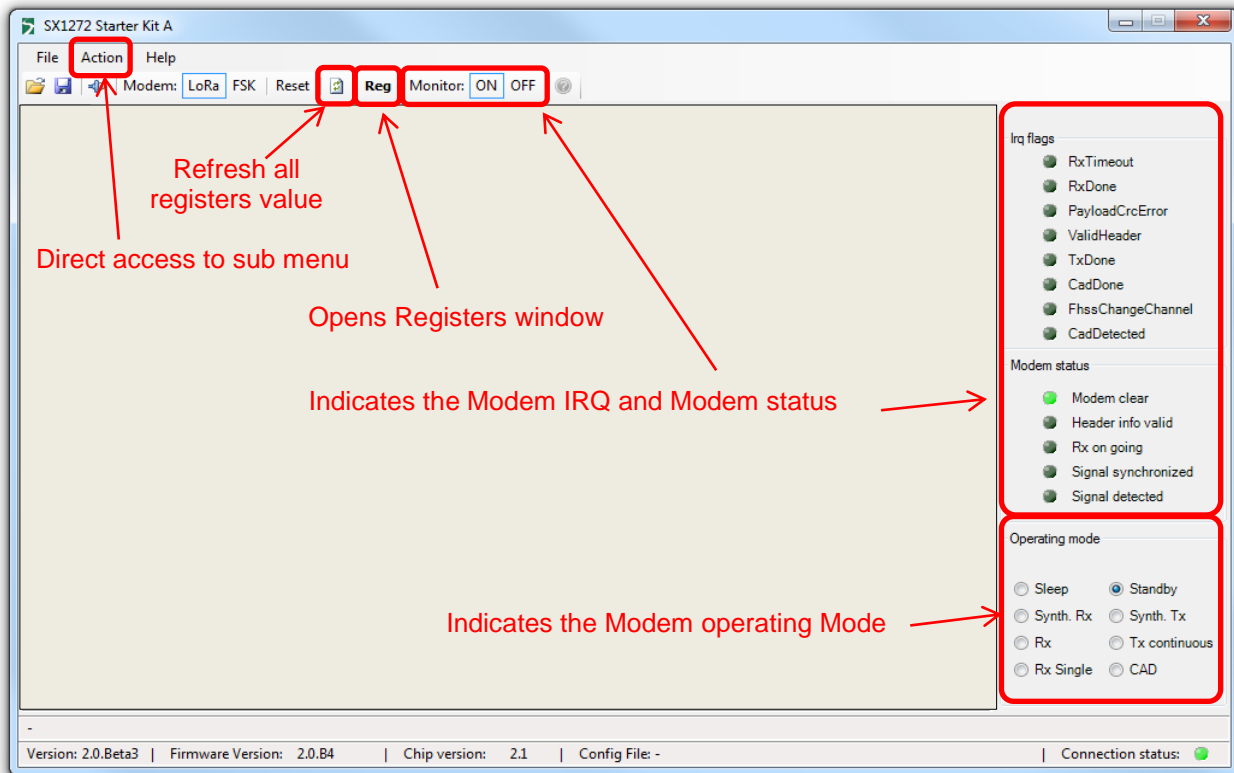

6.2.2 LoRa Common Window

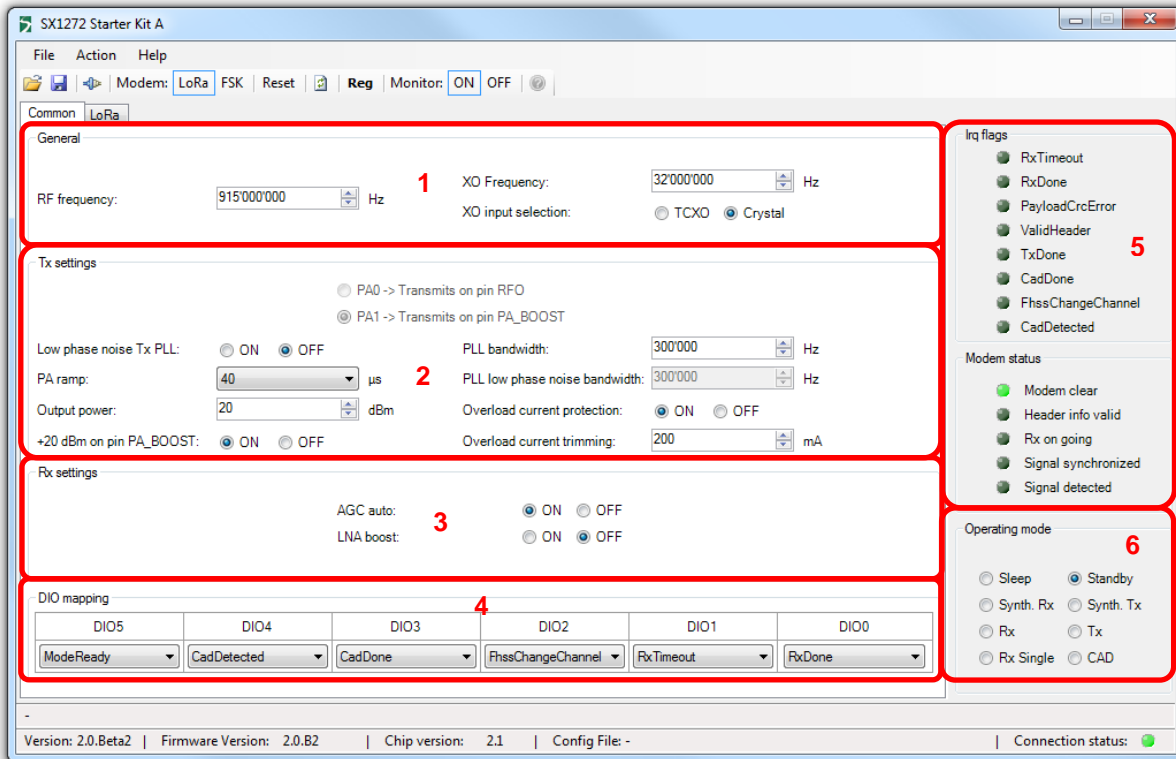

Figure 7: SX1272SKA Boot-up windows

- 1: Set the default basic parameters for the Radio.
- 2: Set the parameters related to the transmission of the data such as output power.
- 3: Set the parameters related to the reception of the data such as AGC or LNA boost settings.
- 4: Set the mapping for the device IO pins. The Status of the IO is then displayed over time in the section 5 of the window.
- 5: This section indicates the modem and DIOs status
- 6: Set the operating mode of the device.

6.2.3 LoRa Parameters Window

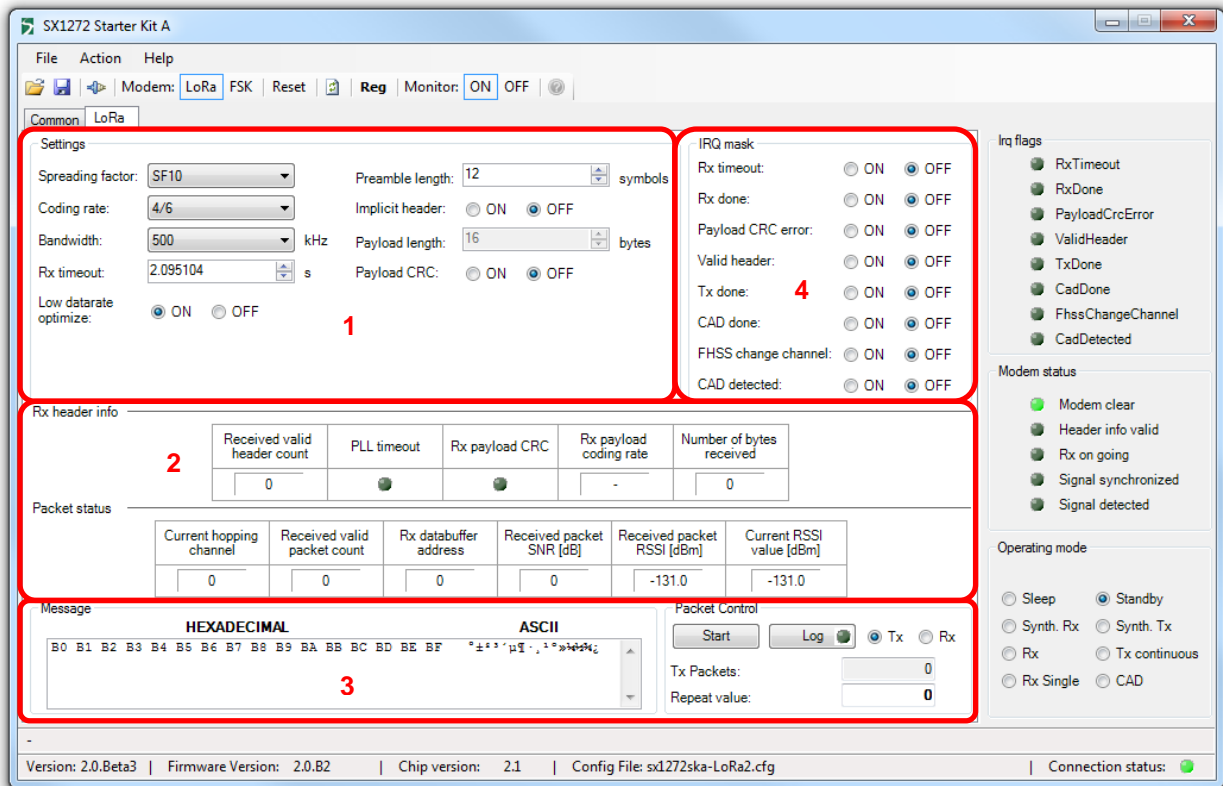

Figure 8: LoRa Radio parameters window

- 1: Set the Radio settings for the LoRa modulation
- 2: Details status of the reception
- 3: Set the payload to be transmitted control the emission or reception of the radio
- 4: Enable or disable the IRQ related to the LoRa modulation

6.3 FSK Mode

6.3.1 FSK Menu

The FSK menu is organized around several windows allowing the user to set the radio step by step. The detail of each window is described from section 5.2.1.1 onward. Some information are however global to the FSK radio operation and are thus displayed on every window as shown on figure 9.

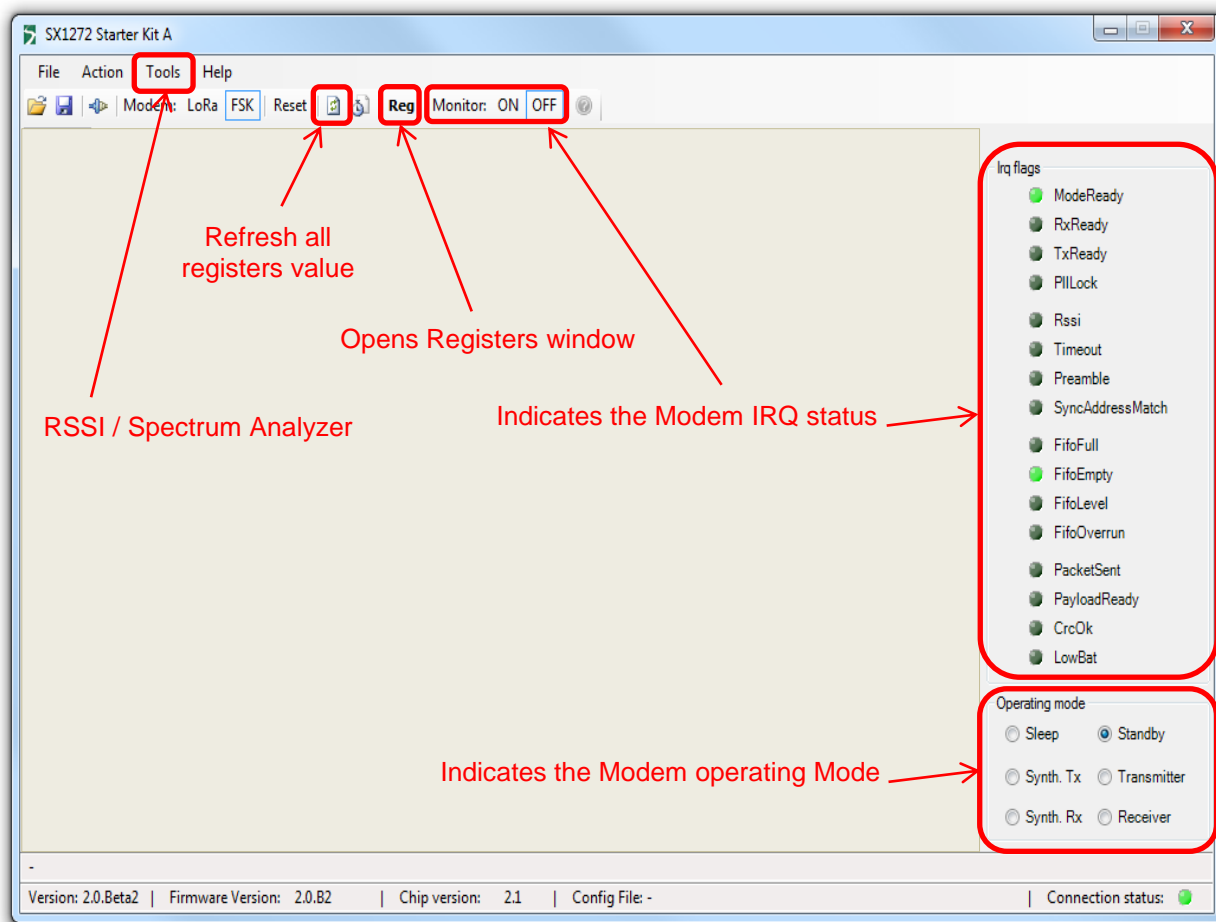

Figure 9: FSK window structure

In FSK mode, it is possible to perform a quantitative spectrum analysis but reading the RSSI value across a range of Frequency. It is also possible to have a qualitative measurement of the RSSI as it is detected by the chipsets. This tool is especially useful when a more expensive spectrum analyzer is not at hand reach.

When Monitor is set to ON, the GUI will constantly scan the status of the FSK IRQ register and displays the status on the right hand side of the GUI. Setting Monitor to OFF disables this features.

6.3.2 Common window

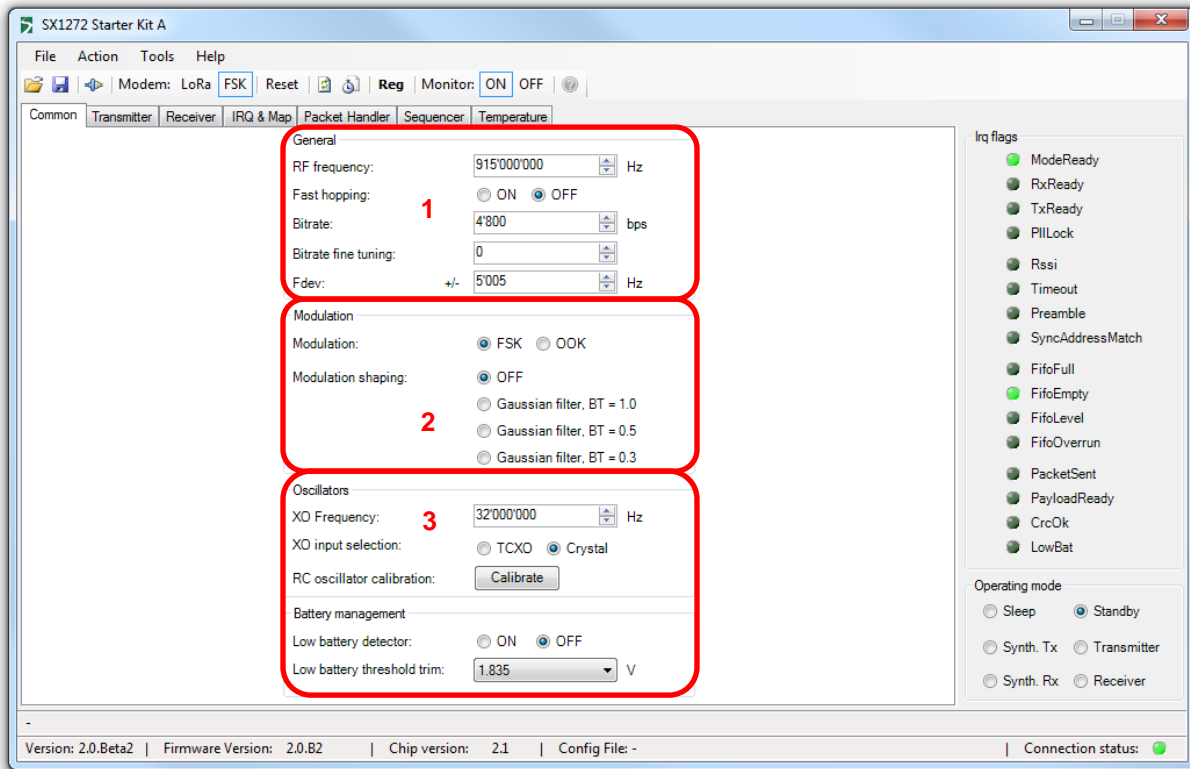

Figure 10: FSK Common window

The Common window allows the user to set the common Tx/Rx parameters for the modulation. Parameters such as the modulation type (FSK or OOK), Frequency, Bitrate, frequency deviation or the oscillator details can be entered in this window.

When Frequency Hopping is used, the control bit “Fast Hoping” need to be set so that the internal PLL can optimize to jump from one frequency to the next in the smallest amount of time.

It is also in this window that the Gaussian Filter parameter is set for the transmission. A general description would be:

- 1: Set the general parameters for the modulation
- 2: Set the modulation Type and the Gaussian filter parameter (Tx Only)
- 3: Set the oscillators parameters

6.3.3 Transmitter window

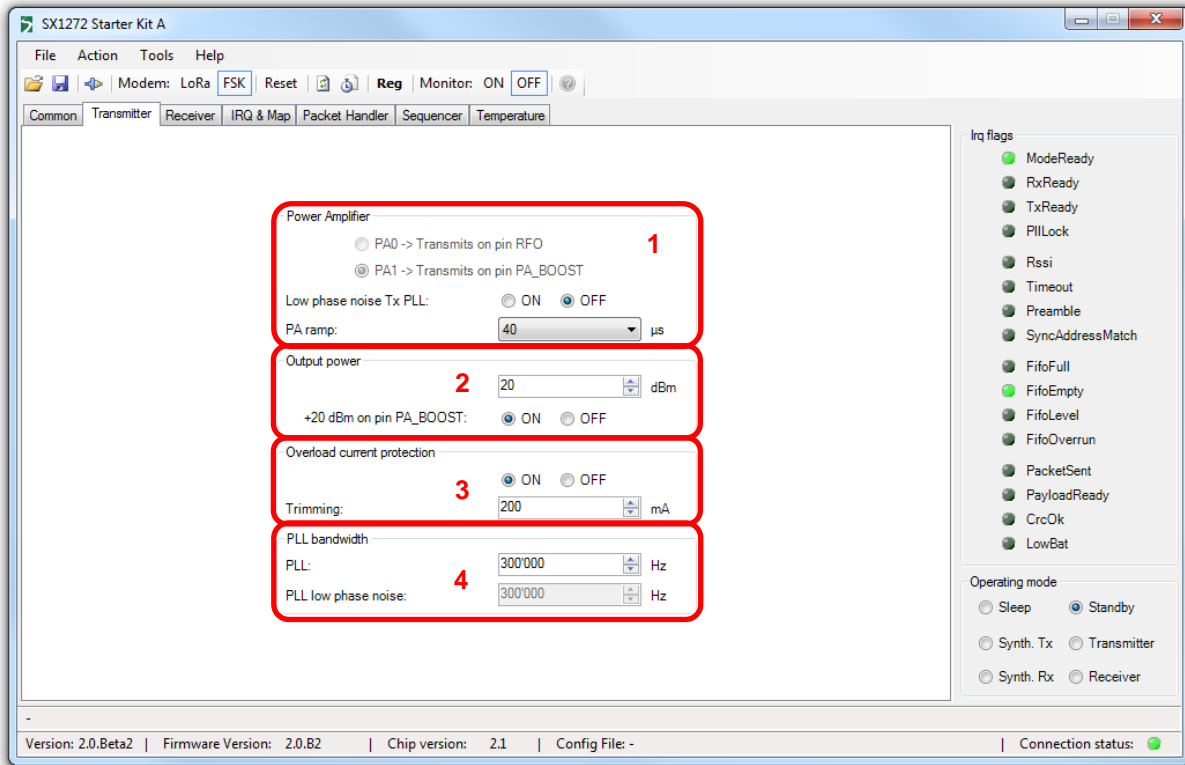

Figure 11: FSK Transmitter window

As indicated through its name, the transmitter window groups the configuration parameters related to the transmission:

- 1: This field allows the user to select the radio output pin. Depending of the SX1272 module version, it may or may not be possible to select the RFO pin as output.
- 2: Set the output power of the radio. The maximum output power is 20dBm.
- 3: Overload current protection
- 4: PLL Bandwidth

6.3.4 Receiver window

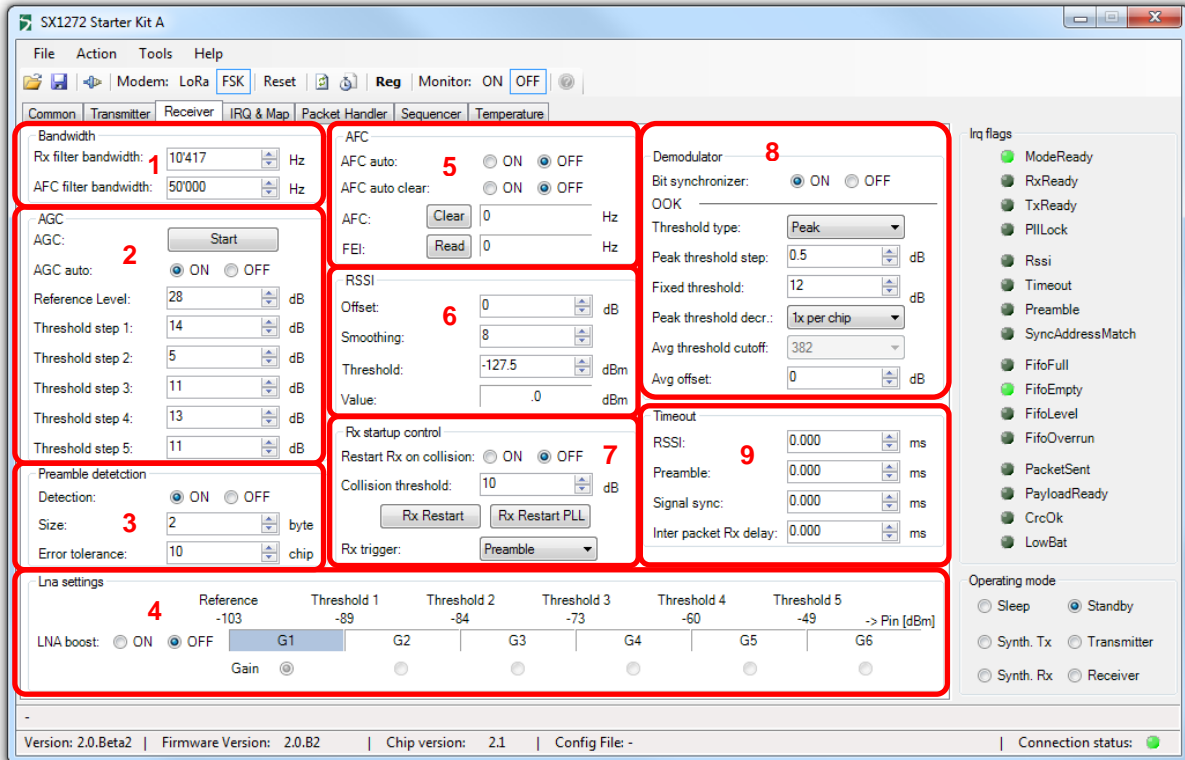

Figure 12: FSK Receiver window

This window allows the user to set the parameters for the packet reception:

- 1: Set the reception bandwidth filter and set the AFC reception bandwidth filter
Please, note that the AFC bandwidth filter is disregarded if AFC Auto is set to OFF
- 2: Enable or disable the AGC and set the step threshold (I am not sure what it does actually)
- 3: Enable or disable the preamble detector and set the preamble detector parameters.
Please, note that the preamble detector must be enabled if the reception is triggered on preamble detection.
- 4: Enable or disable the LNA boost
- 5: Enable or disable the AFC and read the FEI
- 6: Control the RSSI detection. If the reception is triggered on the RSSI detection, these parameters allow controlling the level of RSSI triggering the reception and smoothing the peak detector to avoid false detection in case of random peak in the frequency band.
- 7: These parameters control the events that trig a reception and the behavior of the receiver in case of collision
- 8: Enable or Disable the bit synchronizer and configure the OOK demodulator
- 9: Set internal timing between events

6.3.5 IRQ and Map window

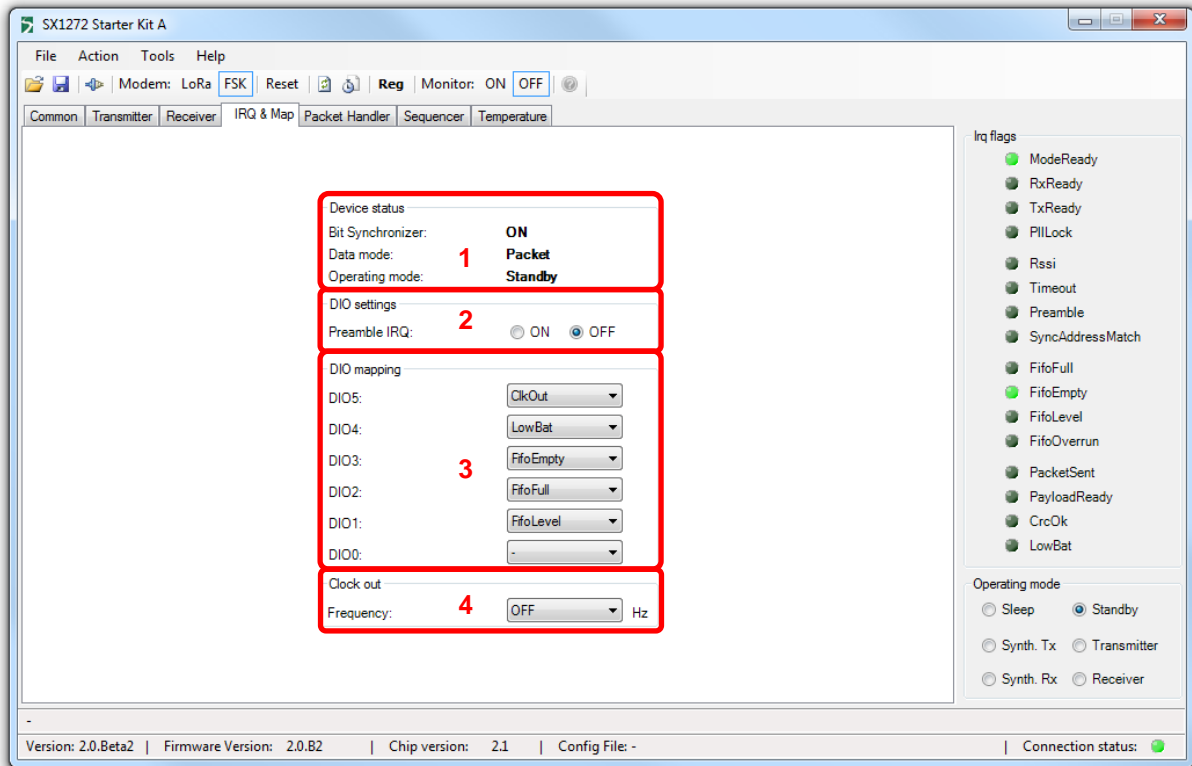

Figure 13: FSK IRQ and Map window

The IRQ and Mapping window is used to set and control the IRQs in the device:

- 1: Indicates the current status of the device
- 2: Enable or disable the preamble detection IRQ (when starting on RSSI detection)
- 3: Configures the IRQ and how they are mapped with the DIOs of the device.
- 4: Disable or Enable and set the clock out of the device

6.3.6 Packet Handler window

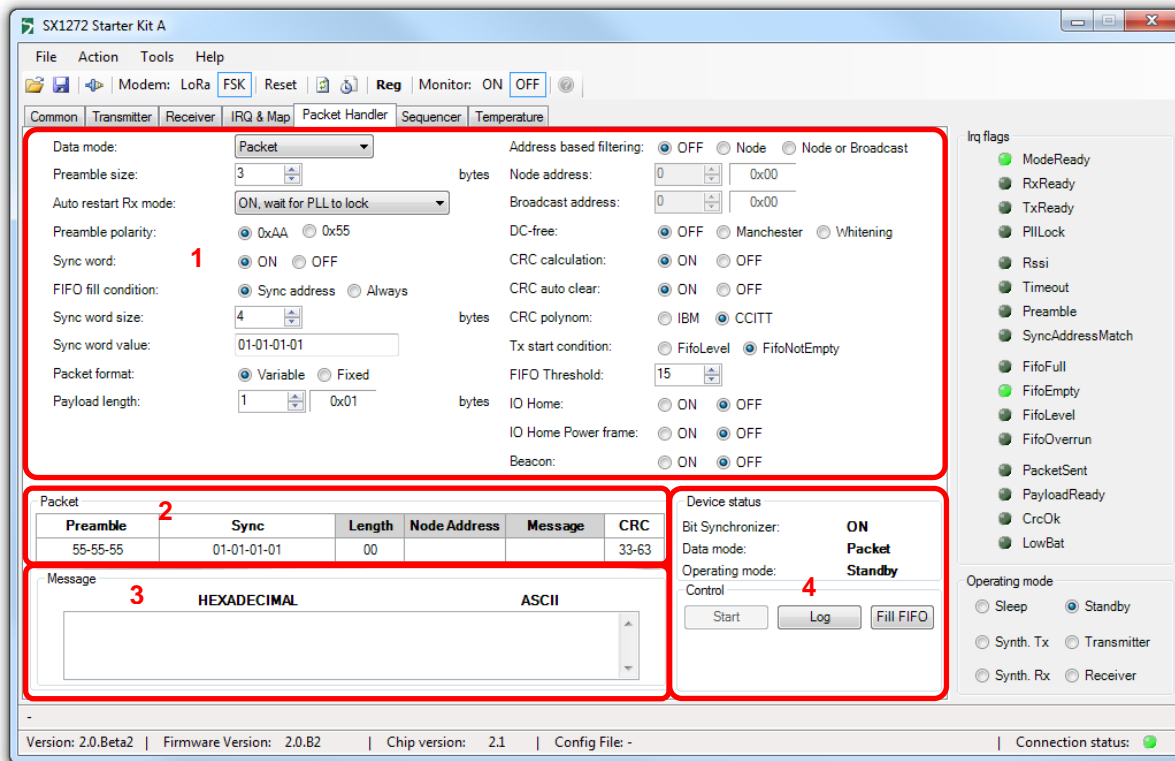

Figure 14: FSK Packet Handler window

The packet handler is the main interface windows to control the transmission or reception of packets once the radio has been setup. Whether in transmission or reception, this window allow the user to defined the packet to be transmitted or to be received

- 1: This field allows the user to define the packet structure.
- 2: Once the packet structure has been defined, this view allows the user that all each field of the packet structure is set correctly.
- 3: Enter the payload to be transmitted or display the payload received.
- 4: Control the packet handler transmission or reception.

6.3.7 Sequencer window

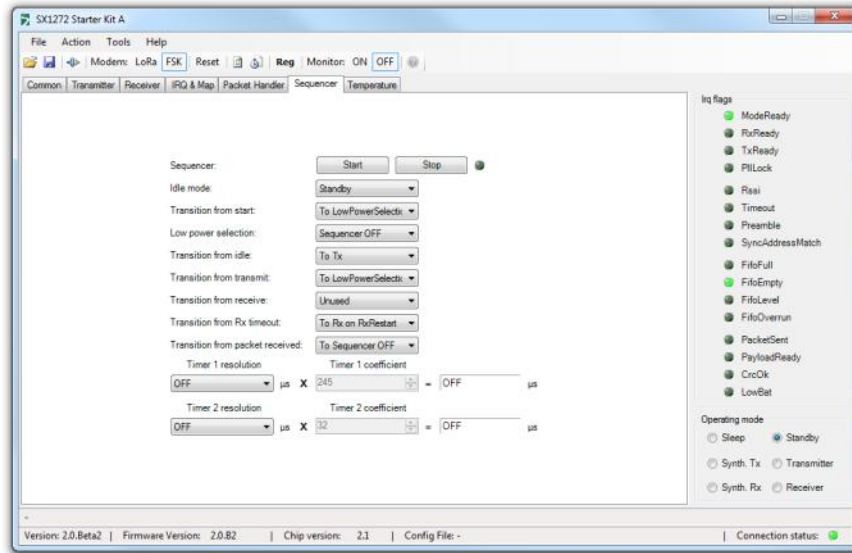

Figure 15: FSK Sequencer window

The sequencer window allows the user to setup the internal state machine of the device and control how the device will react following an event. For more information on the FSK internal state machine, please, refer to the datasheet.

6.3.8 Temperature window

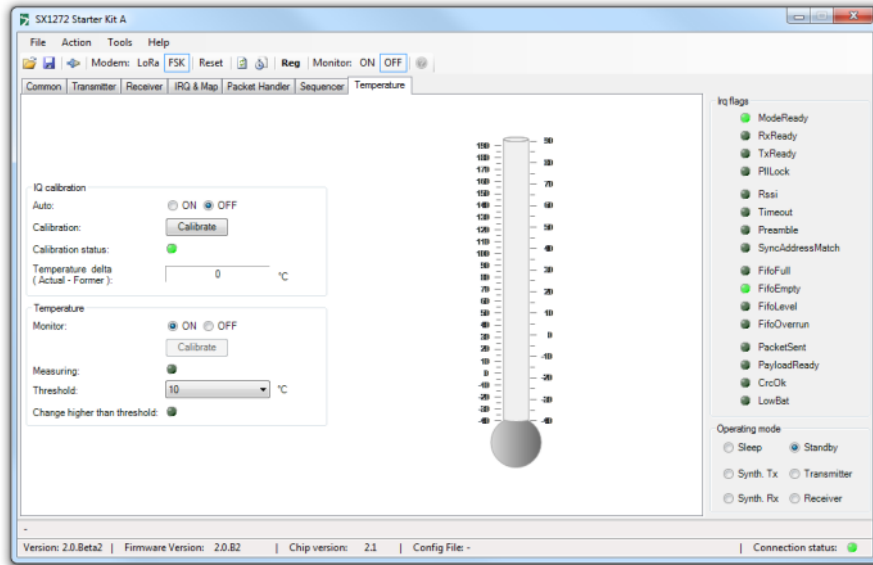

Figure 16: FSK Temperature window

The SX1272 is fitted with an internal temperature sensor. Note that user is prompted to calibrate the SX1272 temperature sensor by clicking on the Calibrate button to access the temperature calibration dialog box. If auto calibration is set, a new calibration will be performed at every temperature change that exceeds the threshold. Threshold value could be set to 5, 10, 15 and 20°C.

7 How to...

7.1 ... perform a simple transmission / reception in LoRa

Performing a simple Transmission – Reception in LoRa is fairly straight forward. First, the user needs to set the RF transmission parameters:

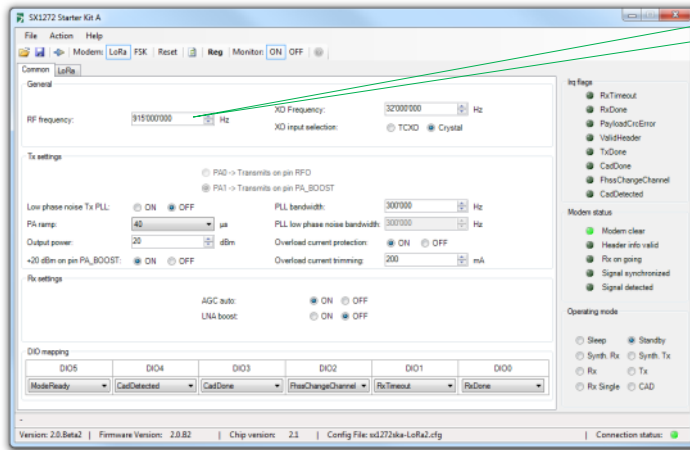

Set the frequency: 915,000,000 Hz

Second, the user needs to set the LoRa modulation parameters:

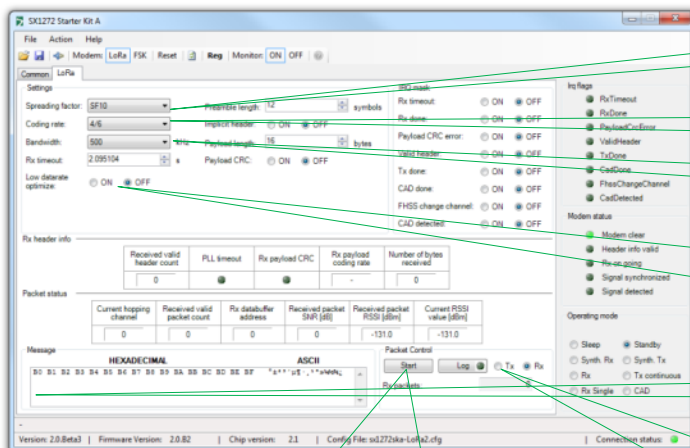

Set the Spreading Factor

Set the Coding Rate

Set the Bandwidth

Optimize transmission for Low Datarate OFF (mandatory for SF11 and SF12 with BW=125KHz)

Set the Payload

Click "Start" to start Transmitting

Set the Device in Transmitter Mode

It is important to notice that the device mode of operation is standby between packets, this is why the Operating mode is left in "Standby".

On the Reception side, the principle is exactly the same. We first need to set the basic radio parameters:

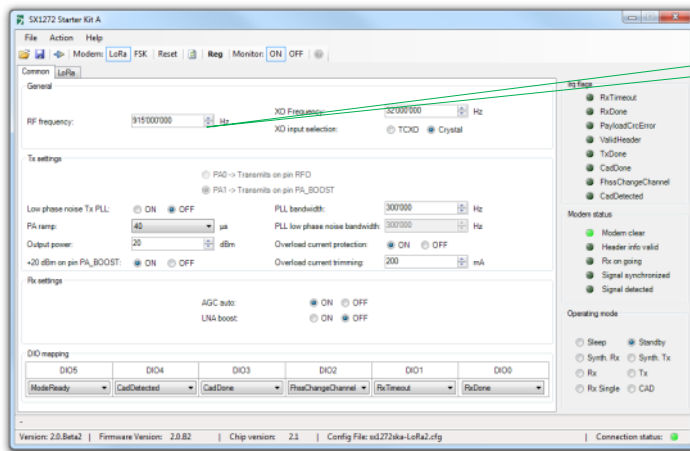

Set the frequency: 915,000,000 Hz

Then we need to set the device in reception after setting the Lora modulation parameters.

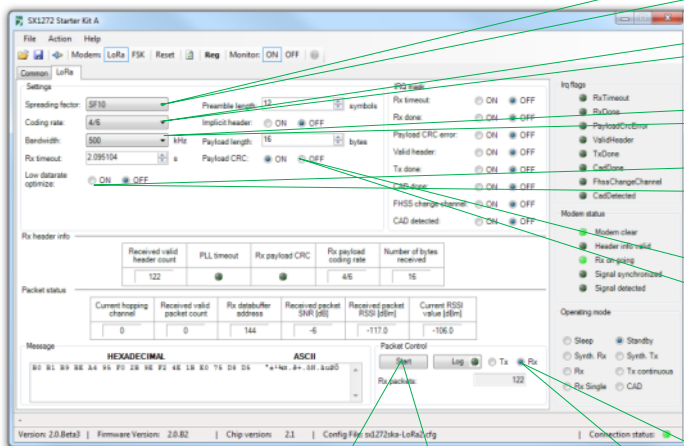

Set the Spreading Factor

Set the Coding Rate

Set the Bandwidth

Optimize transmission for Low datarate
OFF (mandatory for SF11 and SF12)

Enable the payload CRC check

Click "Start" to start Receiving

Set the Device in Receiver Mode

At this stage, the transmission – reception should be complete and the user should see the LEDs blinking on the Eiger platforms.

7.2 ... perform a simple transmission / reception in FSK

First, you need to set the RF parameters for the transmission:

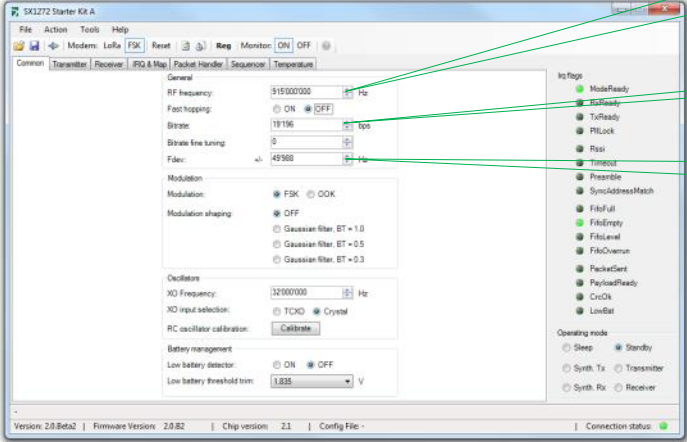

Set the frequency: 915,000,000 Hz

Set the bitrate: 19,200 bps

Set the Frequency deviation: 50,000 Hz

Version: 2.0.Beta2 | Firmware Version: 2.0.B2 | Chip version: 2.1 | Config File: - | Connection status: -

In the transmitter, receiver and IRQ windows, all the parameters can be left at their default values and then we simply need to set our packet structure.

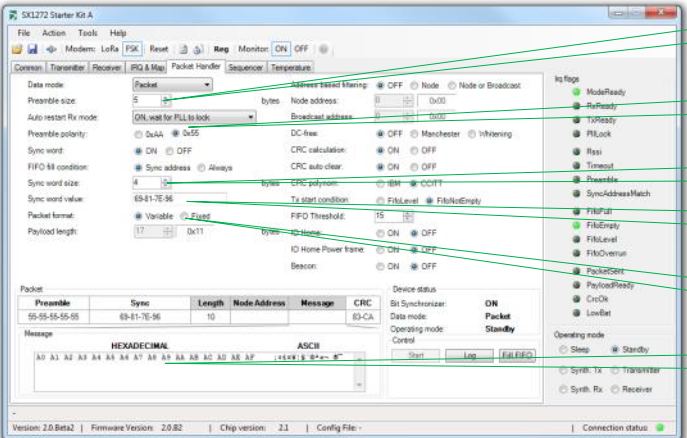

Set the preamble size: 5

Set the preamble polarity: 0x55

Set the Sync Word size: 4

Set the Sync Word: 0x69- 0x81-...

Set the packet length: variable

Set the payload: 0xA1-0xA2-...

Version: 2.0.Beta2 | Firmware Version: 2.0.B2 | Chip version: 2.1 | Config File: - | Connection status: -

WIRELESS & SENSING PRODUCTS

At this stage the radio is fully configured on the transmitter side. We can now set the device in Transmitter mode so that packets are ready to be sent from the device.

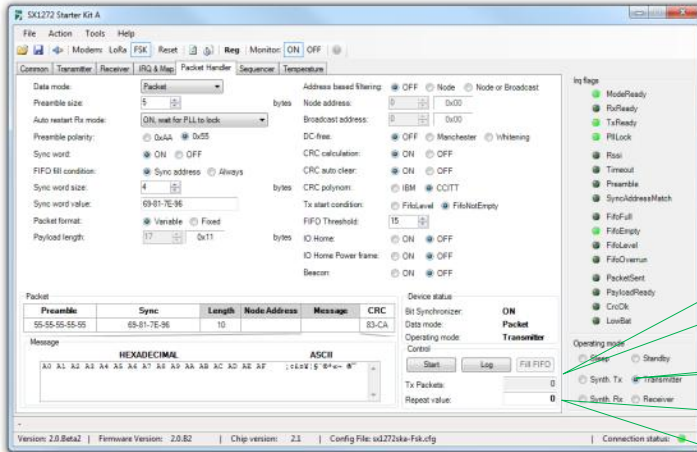

Tx Packets: Indicates the number of packets sent

Set the Device in Transmitter Mode

A small control window appears allowing the user to set the number of packets to be sent. Setting the value to '0' will make the device transmitting indefinitely.

To start sending packets, simply click on the "Start" button.

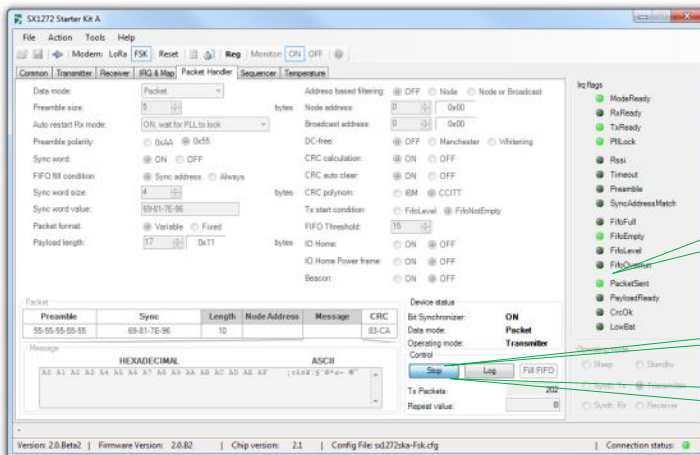

Notice the green LED indicating when a packet is sent

Press "Start" to start sending packets

Press "Stop" to stop sending packets

The device is now sending packet. You can also see the Yellow LED flashing on the Eiger modules to indicate that the device is currently transmitting.

WIRELESS & SENSING PRODUCTS

We must now configure the receiver side. Open a new window of the SX1272SKA and configure the radio as done for the transmitter side. The process is identical:

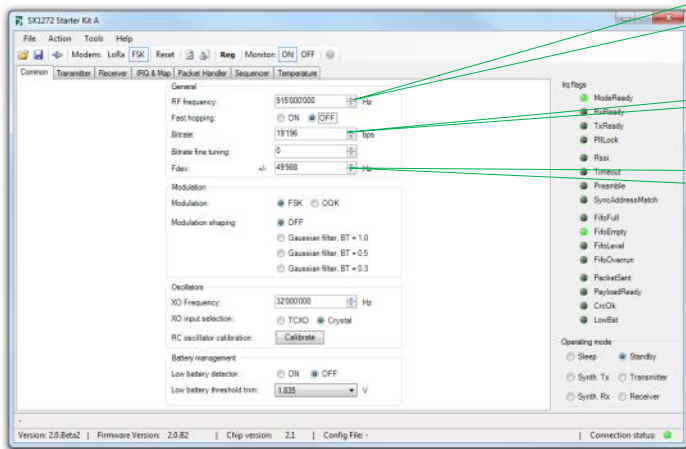

Set the frequency: 915,000,000 Hz

Set the bitrate: 19,200 bps

Set the Frequency deviation: 50,000 Hz

In the receiver, it is necessary to set some parameters to configure the receiver.

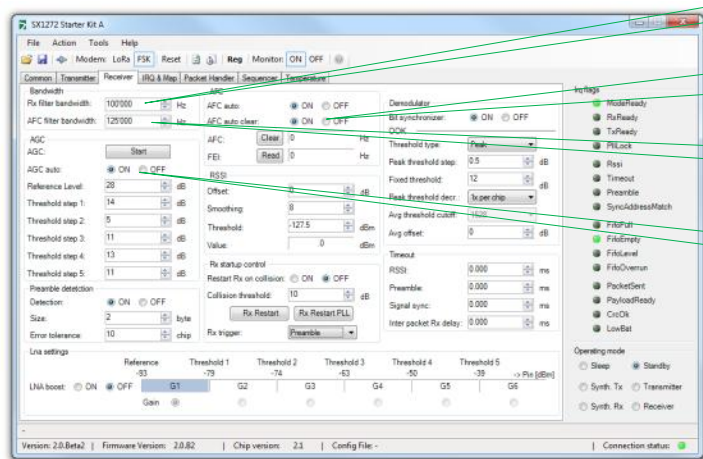

Set the Rx Bandwidth: 100,000 Hz

Set the AFC Auto: ON
Set the AFC Auto clear: ON

Set the Frequency deviation: 50,000 Hz

Set AGC Auto: ON

To finish, the user must simply set the packet handler parameters as in Tx:

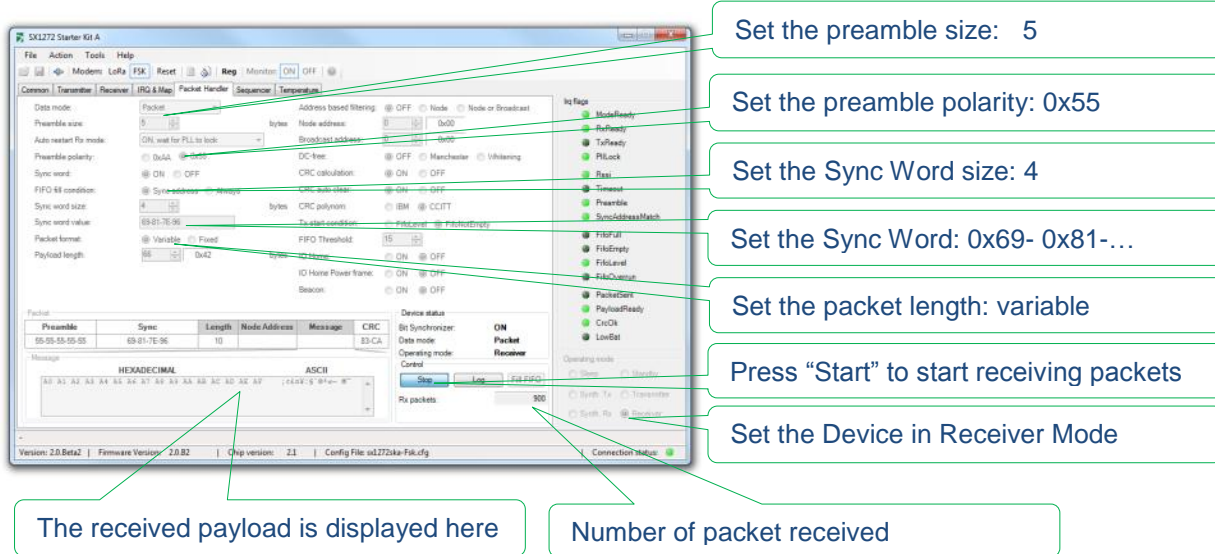

The screenshot shows the SX1272 Starter Kit A software interface. The 'Receiver' tab is selected, and various parameters are configured. Callouts point to specific settings and actions:

- Set the preamble size: 5
- Set the preamble polarity: 0x55
- Set the Sync Word size: 4
- Set the Sync Word: 0x69- 0x81-...
- Set the packet length: variable
- Press "Start" to start receiving packets
- Set the Device in Receiver Mode
- The received payload is displayed here
- Number of packet received

The interface shows a 'Packet' table with the following data:

Preamble	Sync	Length	Node Address	Message	CRC
55-55-55-55	69-81-7E-96	10		0x69-81-7E-96	8D-CA

The 'Device status' section shows 'Bit Synchronizer: ON', 'Data mode: Packet', and 'Operating mode: Receiver'. The 'Rx packets' counter shows 300.

7.3 ... perform Continuous transmission and Reception in LoRa

It is possible to set the SX1272 in Continuous Tx mode to perform a spectral evaluation of the LoRa modulation. In this mode, the SX1272 will be going through the FiFo and send whatever data are present in the RAM.

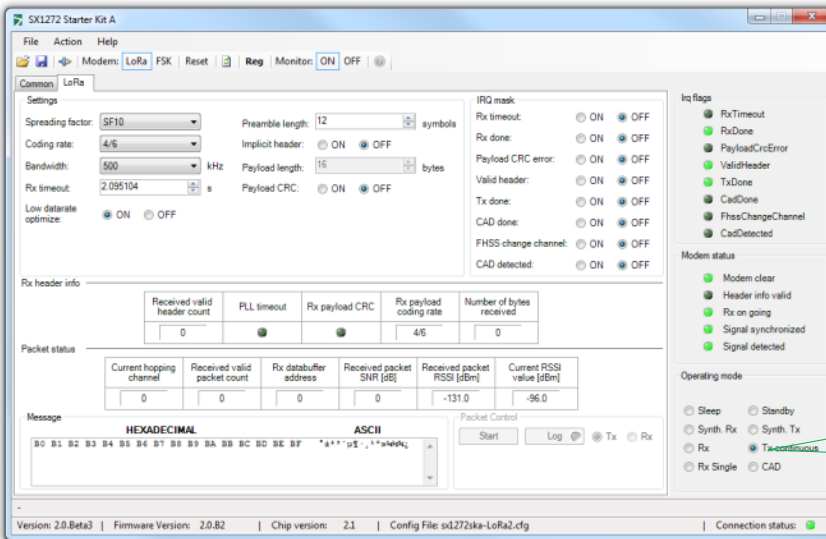

It is also possible to set the device in Continuous Rx mode. In this mode, the device is continuously receiving the packet sent from the transmitter.

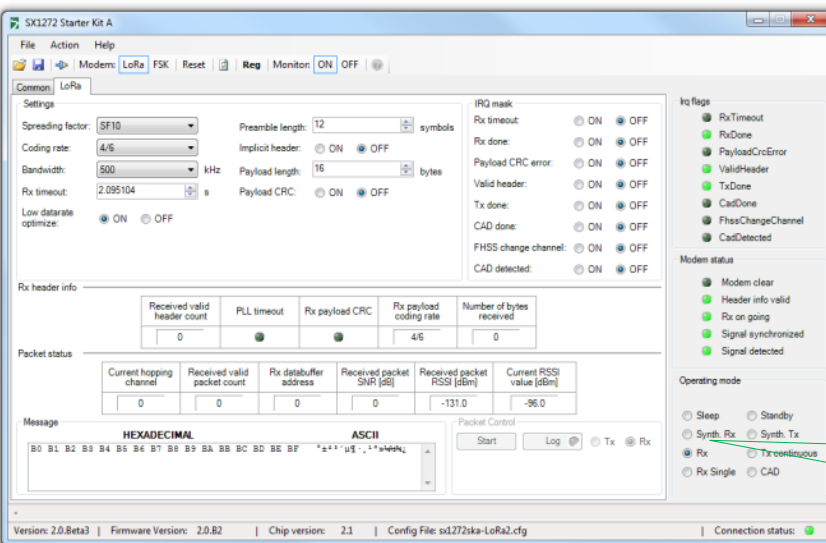

7.4 ... Log the Transmitted or Received packets

The SX1272SKA has a logging facility which allows the user to get the exact time stamps at which a packet has been sent or received and with all the information related to this packet.

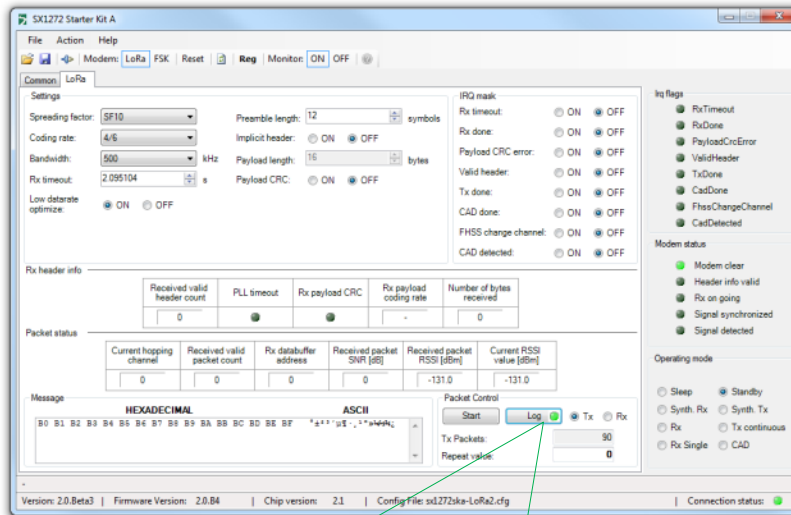

Start the Logging of the transmitted or received packets

Depending if you are in FSK mode or in LoRa mode, a different pop-up window will appear:

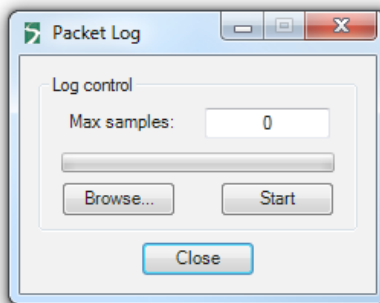

In FSK mode, the packet logger allows to the user to only log a limited amount of packet (indicated by the value “Max Samples”). Then, when the packets are being transmitted or received, the number of desired packets will be logged in the file selected.

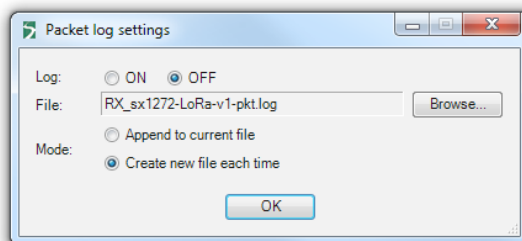

In LoRa mode, the packet logger is enabled or disabled. Once enabled, all transmitted or received packets will be logged in the selected file until the packet logger is disabled.

When enabling the packet logger, it is possible to start a complete new log in a new file or to append an existing file.

7.5 ... perform a CW or PN9 Tx test on the SX1272

The SX1272 does not have a dedicated CW or PN9 Tx test mode implemented. However, it is possible to perform this test manually by setting the device in Tx continuous mode, and feed PN9/15 data stream to the DATA pin (DIO2/DATA), from a signal generator.

7.6 ... check the frequency accuracy of the SX1272 module

There is a very simple way to get the frequency error of the sx1272 modules. The core idea is to set the device in FSK and to set the frequency deviation to 0. In this case, the device will only emit a signal at the center frequency. The difference between the measured value and the set value gives you the frequency error.

8 Troubleshooting

Each Eiger platform, radio module or software kit has been thoroughly tested before to be released for customer evaluation. The section below highlights some of the common issues faced by users and how it can be fixed.

8.1 The Eiger platform indicates very high PER even in short range

There are several reasons which can have a dramatic influence over the performance of the platform. One of the common reasons is that the frequency selected is in the GSM or in another already used frequency band. If the frequency you have selected is already used by another RF system, the communication will obviously be affected. We therefore recommend to the user to check the RF band usage in his location before to start any PER testing.

8.2 The communication range in Lora is very poor

There are two aspects which can limit the LoRa performances: the emission power and the antenna. Please, make sure that we are using enough power to reach the distance you want to achieve. The Eiger platform can output up to 20dBm signals. The other aspect is the antenna, please, make sure the antenna you are using is designed to operate at the frequency region you are transmitting in.

8.3 The SX1272SKA do not detect the device through the USB

This issue is usually caused by a wrong connection of the USB
The step below should fix the issue.

- 1- Make sure the Eiger Platform is powered down (Battery switch set to 0) and is not connected to the PC through the USB.
- 2- Reconnect the side USB to the PC, the red LED on the left side should light up
- 3- Connect the bottom USB to the PC.
- 4- Power the device up (Battery switch set to 1)
- 5- Press the five-way central push button until the screen light up.
- 6- Launch the SX1272SKA on the PC

8.4 The Eiger platform does not seem to work anymore

The battery is probably empty and you should connect the device through the side USB to a computer for a few hours, time for the battery to charge.

8.5 The Eiger platform touch screen is not accurate

This is probably due to a miss-calibration of the touch screen. In this situation, the user should reset the touch screen calibration and perform an accurate calibration using the stylus provided.

© Semtech 2013

All rights reserved. Reproduction in whole or in part is prohibited without the prior written consent of the copyright owner. The information presented in this document does not form part of any quotation or contract, is believed to be accurate and reliable and may be changed without notice. No liability will be accepted by the publisher for any consequence of its use. Publication thereof does not convey nor imply any license under patent or other industrial or intellectual property rights. Semtech assumes no responsibility or liability whatsoever for any failure or unexpected operation resulting from misuse, neglect improper installation, repair or improper handling or unusual physical or electrical stress including, but not limited to, exposure to parameters beyond the specified maximum ratings or operation outside the specified range.

SEMTECH PRODUCTS ARE NOT DESIGNED, INTENDED, AUTHORIZED OR WARRANTED TO BE SUITABLE FOR USE IN LIFE-SUPPORT APPLICATIONS, DEVICES OR SYSTEMS OR OTHER CRITICAL APPLICATIONS. INCLUSION OF SEMTECH PRODUCTS IN SUCH APPLICATIONS IS UNDERSTOOD TO BE UNDERTAKEN SOLELY AT THE CUSTOMER'S OWN RISK. Should a customer purchase or use Semtech products for any such unauthorized application, the customer shall indemnify and hold Semtech and its officers, employees, subsidiaries, affiliates, and distributors harmless against all claims, costs damages and attorney fees

Contact Information

Semtech Corporation
Wireless & Sensing Products Division
200 Flynn Road, Camarillo, CA 93012
Phone: (805) 498-2111 Fax: (805) 498-3804
E-mail: sales@semtech.com
support_rf@semtech.com
Internet: <http://www.semtech.com>