

## LTM4677

# Dual 18A or Single 36A $\mu$ Module Regulator with Digital Power System Management 4x LTM4677; 144A

## DESCRIPTION

Demonstration circuit 2143A-C is a high efficiency, high density,  $\mu$ Module regulator with 4.5V to 16V input range. The output voltage is adjustable from 0.5V to 1.8V, and it can supply 144A maximum load current. The demo board has four LTM<sup>®</sup>4677  $\mu$ Module<sup>®</sup> regulators, and the LTM4677 is a dual 18A or single 36A step-down regulator with PMBus power system management. Please see LTM4677 data sheet for more detailed information

DC2143A-C powers up to default settings and produce power based on configuration resistors without the need for any serial bus communication. This allows easy evaluation of the DC/DC converter. To fully explore the extensive power system management features of the part, download the GUI software LTpowerPlay<sup>®</sup> onto your PC and use

LTC's I<sup>2</sup>C/SMBus/PMBus dongle DC1613A to connect to the board. LTpowerPlay allows the user to reconfigure the part on the fly and store the configuration in EEPROM, view telemetry of voltage, current, temperature and fault status

GUI Download – The software can be downloaded from: <http://www.linear.com/ltpowerplay>

For more details and instructions of LTpowerPlay, please refer to [LTpowerPlay Software GUI](#).

**Design files for this circuit board are available at <http://www.linear.com/demo/DC2143A-C>**

LT, LT, LTC, LTM, Linear Technology, the Linear logo,  $\mu$ Module and LTpowerPlay are registered trademarks of Linear Technology Corporation. All other trademarks are the property of their respective owners.

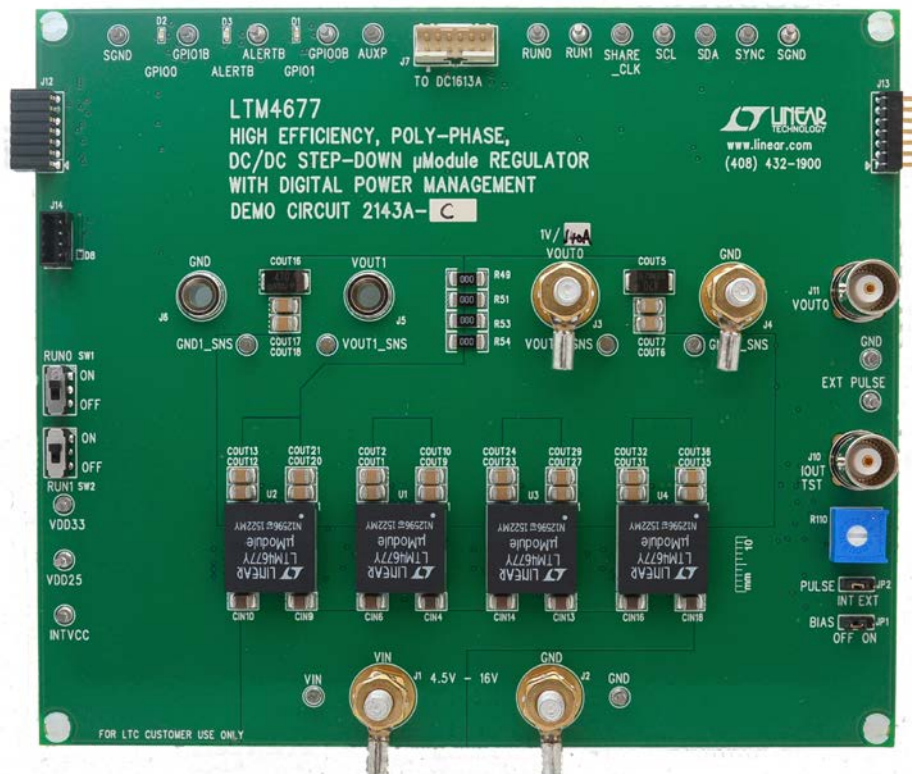

Figure 1. 4x LTM4677; 144A DC2143A-C Demo Circuit

# DEMO MANUAL DC2143A-C

## PERFORMANCE SUMMARY Specifications are at $T_A = 25^\circ\text{C}$

PARAMETER	CONDITION	VALUE
Input Voltage Range		4.5V to 16V
Output Voltage, $V_{OUT0}$	$V_{IN} = 4.5\text{V to }16\text{V}$ , $I_{OUT0} = 0\text{A to }144\text{A}$	0.5V to 1.8V, Default: 1V
Maximum Output Current, $I_{OUT0}$	$V_{IN} = 4.5\text{V to }16\text{V}$ , $V_{OUT} = 0.5\text{V to }1.8\text{V}$	144A
Typical Efficiency	$V_{IN} = 12\text{V}$ , $V_{OUT} = 1.0\text{V}$ , $I_{OUT} = 144\text{A}$	81.8%
Default Switching Frequency		500kHz

## QUICK START PROCEDURE

Table 1. LTM4677 Demo Cards for Up to 144A Point-of-Load Regulation

MAXIMUM OUTPUT CURRENT	NUMBER OF OUTPUT VOLTAGES	NUMBER OF LTM4677 $\mu$ MODULE REGULATORS ON THE BOARD	DEMO BOARD NUMBER
Dual 18A	2	1	DC2066A
72A	1	2	DC2143A-A
108A	1	3	DC2143A-B
144A	1	4	DC2143A-C

Demonstration circuit 2143A-C is easy to set up to evaluate the performance of the LTM4677EY. Refer to Figure 2 for the proper measurement equipment setup and follow the procedure below.

1. With power off, connect the input power supply to  $V_{IN}$  (4.5V to 16V) and GND (input return).
2. Connect the 1.0V output load between  $V_{OUT}$  and GND (Initial load: no load).
3. Connect the DVMs to the input and outputs. Set default switch position: SW1: ON; SW2: ON.
4. Turn on the input power supply and check for the proper output voltages.  $V_{OUT0}$  should be  $1.0\text{V} \pm 1\%$ .
5. Once the proper output voltages are established, adjust the loads within the operating range and observe the output voltage regulation, ripple voltage and other parameters.

6. Connect the dongle and control the output voltages from the GUI. See LTpowerPlay GUI for the LTM4677 Quick Start Guide for details.

Note: When measuring the output or input voltage ripple, do not use the long ground lead on the oscilloscope probe. See Figure 3 for the proper scope probe technique. Short, stiff leads need to be soldered to the (+) and (-) terminals of an output capacitor. The probe's ground ring needs to touch the (-) lead and the probe tip needs to touch the (+) lead.

### Connecting a PC to DC2143A-C

You can use a PC to reconfigure the power management features of the LTM4677 such as: nominal  $V_{OUT}$ , margin set points, OV/UV limits, temperature fault limits, sequencing parameters, the fault log, fault responses, GPIOs and other functionality. The DC1613A dongle may be plugged when  $V_{IN}$  is present.

**QUICK START PROCEDURE**

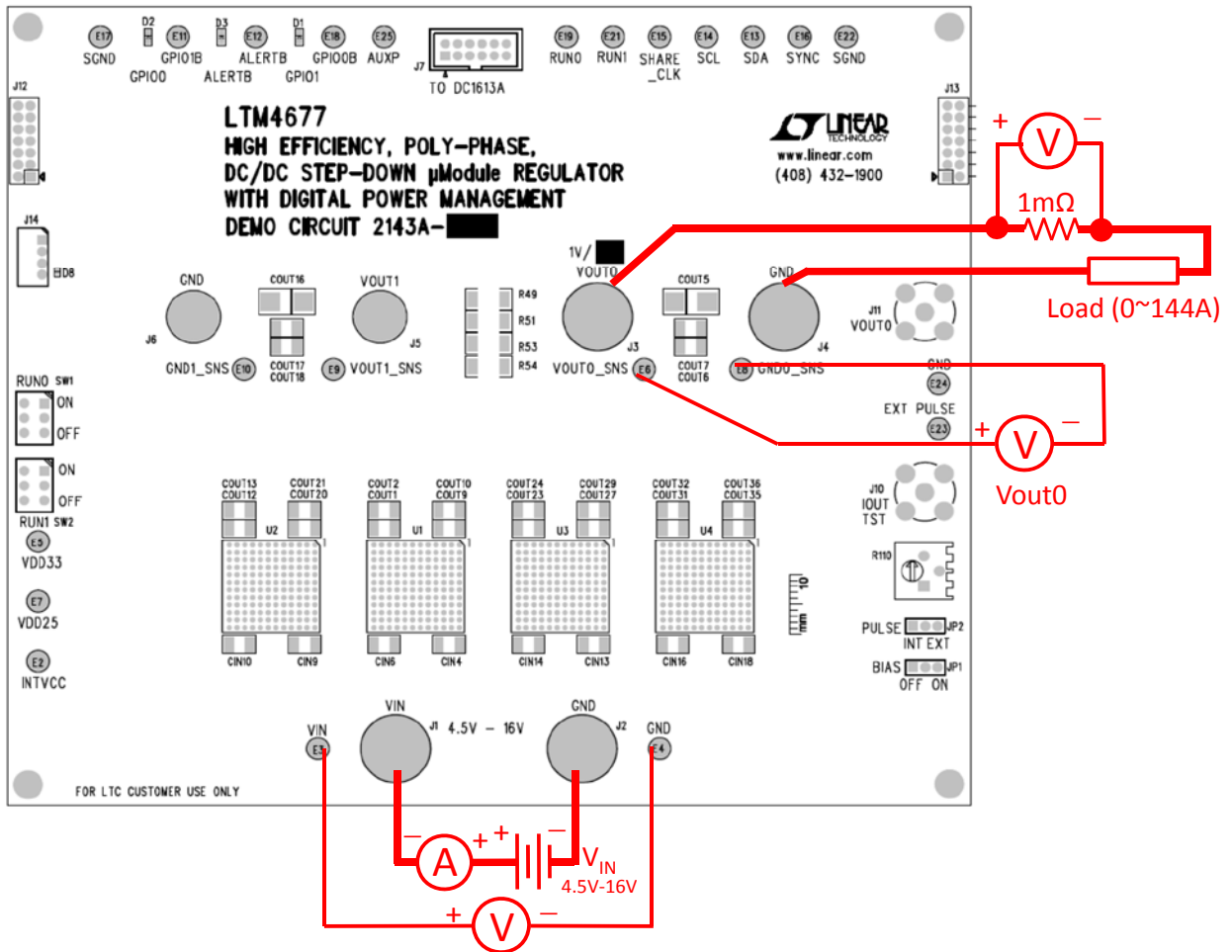

Figure 2. Proper Measurement Equipment Setup

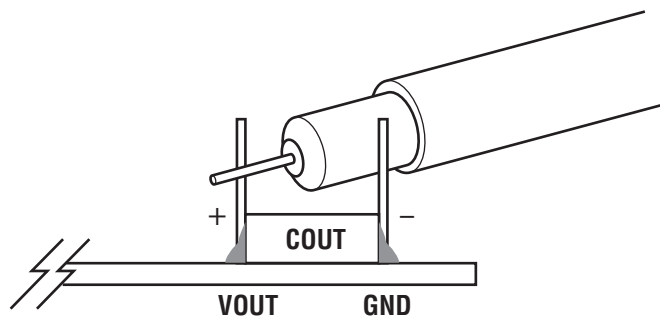

Figure 3. Measuring Output Voltage Ripple

## QUICK START PROCEDURE

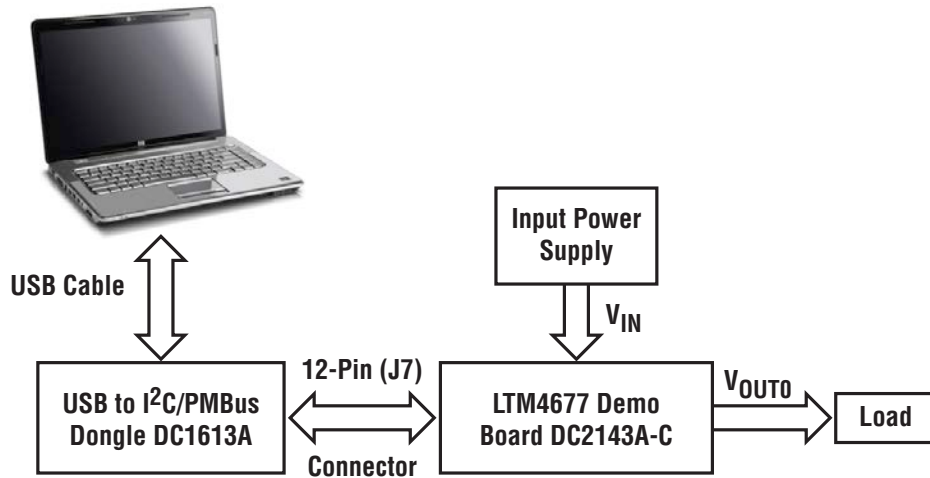
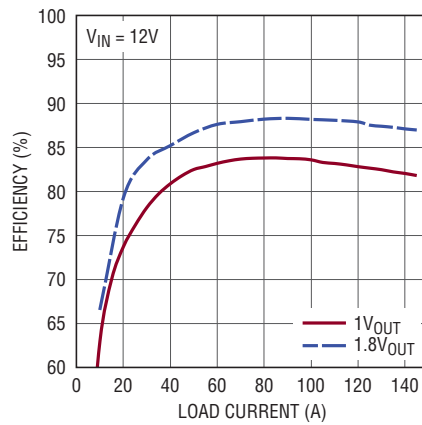
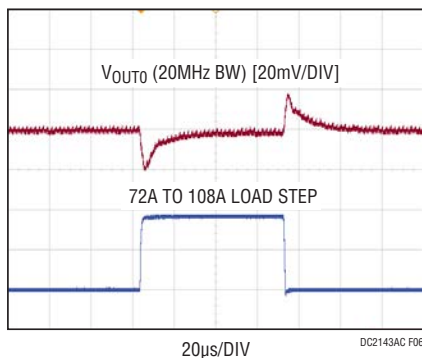

Figure 4. Demo Setup with PC



DC2143AC F05

Figure 5. Efficiency vs Load Current at  $V_{OUT} = 1V$  and  $V_{OUT} = 1.8V$ ,  $f_{sw} = 500kHz$



DC2143AC F06

Figure 6. Output Voltage  $V_{OUT0}$  vs Load Current at  $V_{IN} = 12V$ ,  $V_{OUT0} = 1V$

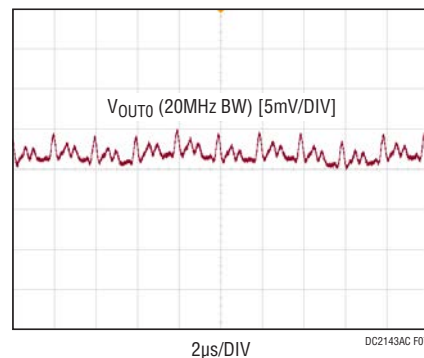

DC2143AC F07

Figure 7. Output Voltage Ripple at  $V_{IN} = 12V$ ,  $V_{OUT0} = 1V$ ,  $I_{OUT0} = 144A$

**QUICK START PROCEDURE**

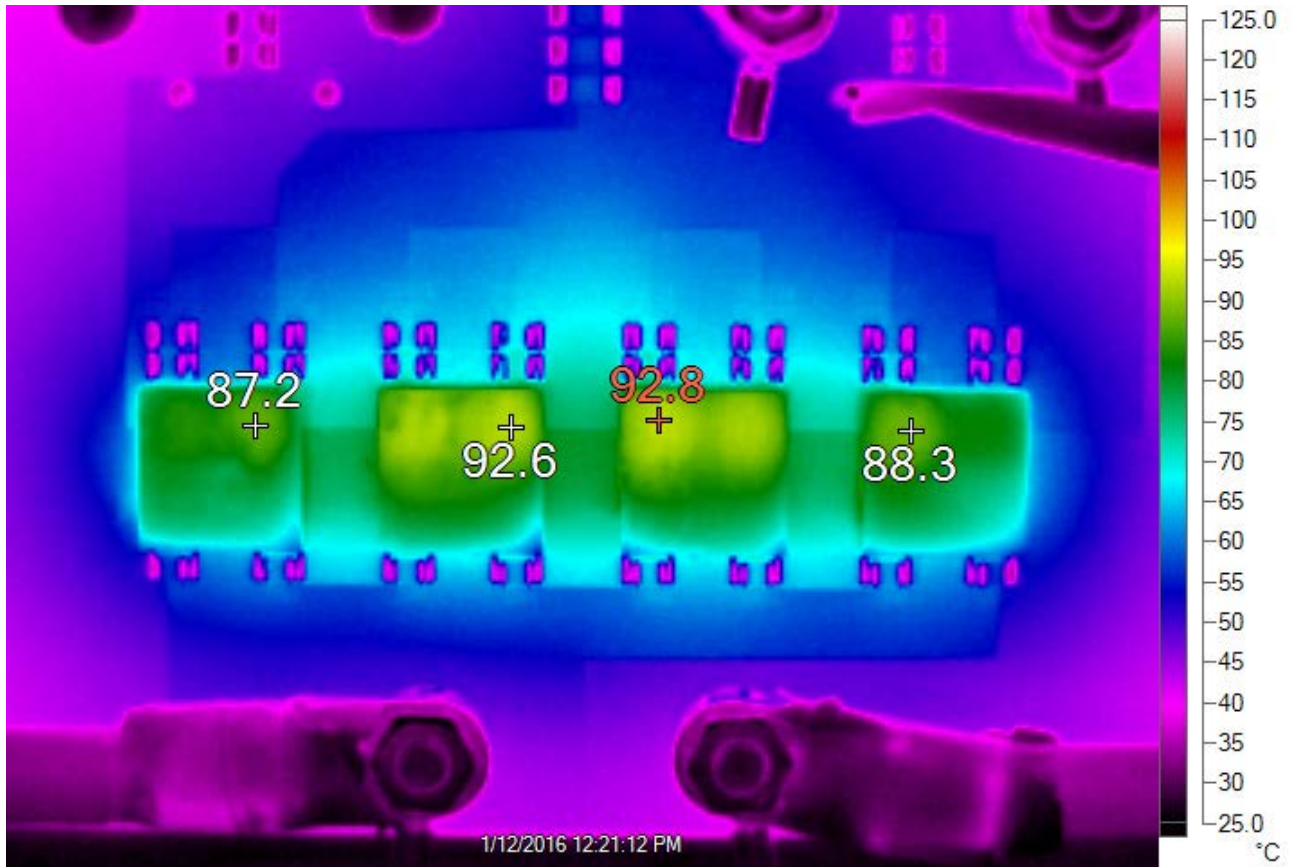

Figure 8. Thermal Performance at  $V_{IN} = 12V$ ,  $V_{OUT0} = 1V$ ,  $I_{OUT0} = 144A$ ,  $T_A = 23.8^{\circ}C$ , Air Flow 400LFM

## LTPowerPLAY SOFTWARE GUI

LTpowerPlay is a powerful Windows based development environment that supports Linear Technology power system management ICs, including the LTM4677, LTC3880, LTC3883, LTC2974 and LTC2978. The software supports a variety of different tasks. You can use LTpowerPlay to evaluate Linear Technology ICs by connecting to a demo board system. LTpowerPlay can also be used in an offline mode (with no hardware present) in order to build a multichip configuration file that can be saved and reloaded at a later time. LTpowerPlay provides unprecedented diagnostic and debug features. It becomes a valuable diagnostic tool during board bring-up to program or tweak the power management scheme in a system, or to diagnose power

issues when bringing up rails. LTpowerPlay utilizes the DC1613A USB-to-SMBus controller to communicate with one of many potential targets, including the LTM4677, the LTC3880 and the LTC3883's demo system, or a customer board. The software also provides an automatic update feature to keep the software current with the latest set of device drivers and documentation. The LTpowerPlay software can be downloaded from:

<http://www.linear.com/ltpowerplay>

To access technical support documents for LTC Digital Power Products visit Help. View online help on the LTpowerPlay menu.

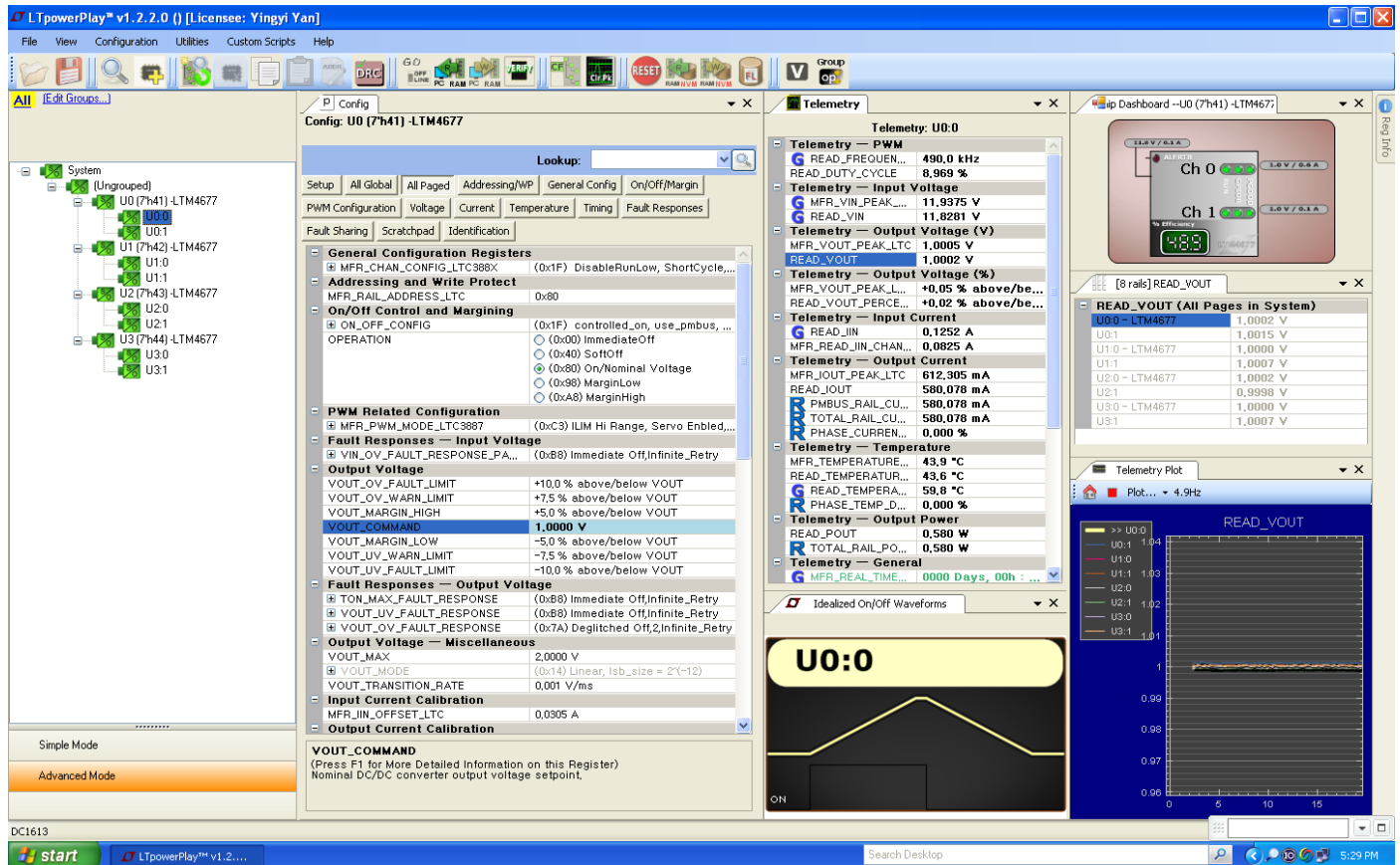
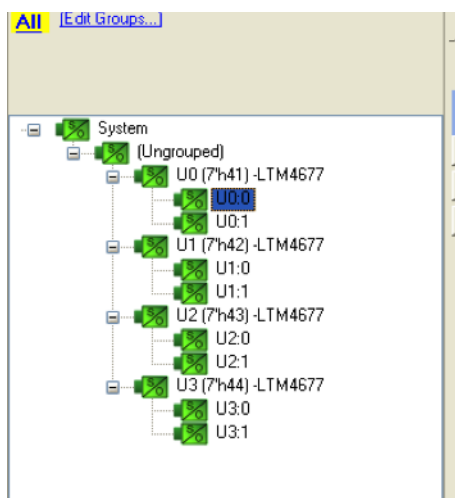

Figure 9. LTpowerPlay Main Interface

## LTPOWERPLAY QUICK START PROCEDURE

The following procedure describes how to use LTpowerPlay to monitor and change the settings of LTM4677.

1. Download and install the LTpowerPlay GUI:  
<http://www.linear.com/ltpowerplay>
2. Launch the LTpowerPlay GUI.
  - a. The GUI should automatically identify the DC2143A-C. The system tree on the left hand side should look like this:



- b. A green message box shows for a few seconds in the lower left hand corner, confirming that LTM4677 is communicating:

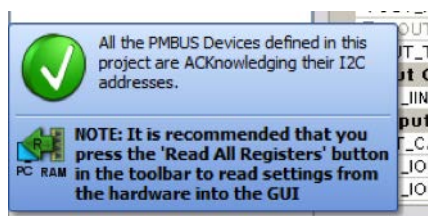

- c. In the Toolbar, click the “R” (RAM to PC) icon to read the RAM from the TM4677. This reads the configuration from the RAM of LTM4677 and loads it into the GUI.



- d. If you want to change the output voltage to a different value, like 1.5V. In the Config tab, type in 1.5 in the VOUT\_COMMAND box, like this:

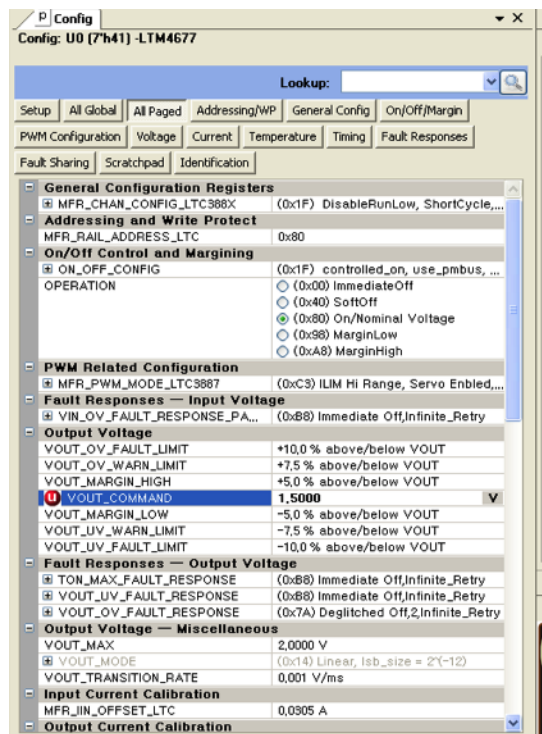

Then, click the “W” (PC to RAM) icon to write these register values to the LTM4677. After finishing this step, you will see the output voltage will change to 1.5V.



If the write is successful, you will see the following message:



- e. You can save the changes into the NVM. In the toolbar, click “RAM to NVM” button, as following



- f. Save the demo board configuration to a (\*.proj) file. Click the Save icon and save the file. Name it whatever you want.

# DEMO MANUAL DC2143A-C

## PARTS LIST

ITEM	QTY	REFERENCE	PART DESCRIPTION	MANUFACTURER/PART NUMBER
<b>Required Circuit Components</b>				
1	18	CIN1, CIN2, CIN4, CIN5, CIN6, CIN7, CIN8, CIN9, CIN10, CIN11, CN12-CN19	CAP, X5R, 10 $\mu$ F, 35V, 10%,1210	MURATA, GRM32ER6YA106KA12L
2	1	CIN3	CAP, 150 $\mu$ F, 35V, ALUMINUM ELECTR.	SUN ELECT., 35CE150AX
3	28	COUT1,COUT2, COUT3, COUT6, COUT7, COUT9, COUT10, COUT11, COUT12, COUT13, COUT14, COUT17, COUT18, COUT20,COUT21, COUT22, COUT23, COUT24, COUT25, COUT27, COUT29, COUT30, COUT31, COUT32, COUT33, COUT35, COUT36, COUT37	CAP, X5R, 100 $\mu$ F, 6.3V, 20% 1210	MURATA, GRM32ER60J107ME20K
4	10	COUT4, COUT5, COUT8, COUT15, COUT16, COUT19, COUT26, COUT28, COUT34, COUT38	POSCAP, 470 $\mu$ F, 2.5V, SP-CAP, D3L	PANASONIC, EEF-LX0E471E4
5	1	C3	CAP., X7R, 220pF, 16V, 10%, 0603	AVX, 0603YC221KAT2A
6	1	C4	CAP., X7R, 6800pF, 16V, 10%,0603	AVX, 0603YC682KAT2A
7	4	C5, C12, C33, C34	CAP., X5R, 0.01 $\mu$ F, 16V, 10%,0603	AVX, 0603YD103KAT2A
8	1	C32	CAP., X5R, 0.1 $\mu$ F, 16V, 10%,0603	MURATA, GRM188R61C104KA01D
9	1	C64	CAP., X5R, 4.7 $\mu$ F, 25V,10%, 0603	MURATA, GRM188R61E475KE11D
10	2	C65, C68	CAP., X7R, 1 $\mu$ F, 25V,10%, 1206	MURATA, GRM31MR71E105KA01L
11	1	C66	CAP., X5R, 0.22 $\mu$ F, 25V,10%, 0805	AVX, 08053D224KAT2A
12	1	C67	CAP., X7R, 0.1 $\mu$ F, 25V,10%, 1206	AVX, 12063C104KAT2A
13	1	C69	CAP., X7R, 150pF, 25V,10%, 0603	AVX, 06033C151KAT2A
14	1	C70	CAP., X5R, 1 $\mu$ F, 25V,10%, 0805	MURATA, GRM216R61E105KA12D
15	2	D1, D2	SMT CHIP LED, GREEN	WURTH ELEKTRONIK, 150060GS75000
16	1	D3	SMT CHIP LED, RED	WURTH ELEKTRONIK, 150060SS75000
17	1	D8	DIODE SCHOTTKY 20V 500MA SOD882 2-PIN	NXP SEMI., PMEG2005AEL, 315
18	1	Q2	MOSFET P-CH 20V 0.58A SOT-23	VISHAY, SI2365EDS-T1-GE3
19	2	Q3, Q4	MOSFET N-CH 60V 115MA SOT-23	FAIRCHILD, 2N7002K
20	2	Q11, Q12	MOSFET N-CH 30V 63A T0252	VISHAY, SUD50N04-8M8P-4GE3
21	1	Q19	MOSFET P-CH 30V 3.5A SOT-23	DIODES INC., DMP3130L-7
22	24	R2, R4, R18, R25, R26, R30, R32, R47, R48, R50, R56, R58, R60, R72, R74, R104, R120, R121, R122, R131, R135, R143	RES., CHIP, 0 $\Omega$ , 1%, 0603	VISHAY CRCW06030000Z0EA
23	15	R6, R7, R8, R9, R10, R11, R12, R15, R35, R36, R39, R64, R78, R116, R130	RES., CHIP, 10k, 1%, 0603	VISHAY CRCW060310K0FKEA
24	1	R14	RES., CHIP, 2k, 1%, 0603	VISHAY CRCW06032K00FKEA
25	4	R16, R41, R125, R129	RES., CHIP, 10 $\Omega$ , 1%, 0603	VISHAY CRCW060310R0FKEA
26	1	R19	RES., CHIP, 787 $\Omega$ , 1%, 0603	VISHAY CRCW0603787RFKEA
27	4	R49, R51, R53, R54	RES., CHIP, 0 $\Omega$ , 1%, 2010	VISHAY CRCW20100000Z0EF
28	2	R85, R124	RES., CHIP, 200 $\Omega$ , 1%, 0603	VISHAY CRCW0603200RFKEA
29	1	R86	RES., CHIP, 127 $\Omega$ , 1%, 0603	VISHAY CRCW0603127RFKEA
30	1	R105	RES., CHIP, 681k, 1%, 0603	VISHAY CRCW0603681KFKEA
31	1	R106	RES., CHIP, 3.3 $\Omega$ , 1%, 0603	VISHAY CRCW06033R30FKEA
32	1	R107	RES., CHIP, 82.5 $\Omega$ , 1%, 0603	VISHAY CRCW060382R5FKEA
33	2	R108, R118	RES., CHIP, 0.01 $\Omega$ , 1%, 2010	VISHAY, WSL2010R0100FEA
34	1	R109	RES., CHIP, 100k, 1%, 0603	VISHAY CRCW0603100KFKEA
35	1	R110	TRIMMING POTENTIOMETER, 5k	BOURNS, 3386P-1-502LF
36	2	R111, R115	RES., CHIP, 20k, 1%, 0603	VISHAY CRCW060320K0FKEA
37	1	R112	RES., CHIP, 100 $\Omega$ , 1%, 0603	VISHAY CRCW0603100RFKEA
38	1	R113	RES., CHIP, 1.4k, 1%, 0603	VISHAY CRCW06031K40FKEA



## PARTS LIST

ITEM	QTY	REFERENCE	PART DESCRIPTION	MANUFACTURER/PART NUMBER
39	1	R114	RES., CHIP, 154k, 1%, 0603	VISHAY CRCW0603154KFKEA
40	1	R117	RES., CHIP, 2Ω, 1%, 0603	VISHAY CRCW06032R00FKEA
41	1	R123	RES., CHIP, 1M, 1%, 0603	VISHAY CRCW06031M00FKEA
42	2	R134, R144	RES., CHIP, 4.99k, 1%, 0603	VISHAY CRCW06034K99FKEA
43	1	R141	RES., CHIP, 15.8k, 1%, 0603	VISHAY CRCW060315K8FKEA
44	2	U1, U2	IC, LTM4677EY	LINEAR TECH., LTM4677EY#PBF
45	2	U3, U4	IC, LTM4677EY	LINEAR TECH., LTM4677EY#PBF
46	1	U6	IC., LT1129CS8-5, S8	LINEAR TECH. LT1129CS8-5#PBF
47	1	U7	IC., LTC6992-1, S6-TSOT	LINEAR TECH. LTC6992CS6-1#PBF
48	1	U8	IC., LT1803IS5, S5-TSOT	LINEAR TECH. LT1803IS5#PBF
49	1	U9	IC., EEPROM 2KBIT 400kHz 8-TSSOP	MICROCHIP, 24LC025-I/ST
50	2	R40, R42	RES., CHIP, 1.65k, 1%, 0603	VISHAY CRCW06031K65FKEA
51	2	R65, R80	RES., CHIP, 2.43k, 1%, 0603	VISHAY CRCW06032K43FKEA
52	2	R66, R79	RES., CHIP, 3.24k, 1%, 0603	VISHAY CRCW06033K24FKEA

### Additional Demo Board Circuit Components

1	0	COUT39, COUT40, COUT41, COUT42, COUT43, COUT44, COUT45, COUT46	OPTIONAL D3L	
2	0	C1, C2, C6, C8, C9, C10, C11, C13, C14, C15, C16, C17, C18, C19, C20	OPTIONAL 0603	
3	0	C7	OPTIONAL 0603	
4	0	D4, D5	DIODE SOD323 OPTIONAL	
5	0	R1, R3, R5, R13, R17, R20, R21, R22, R23, R24, R27, R28, R29, R31, R33, R34, R37, R38, R43, R44, R45, R46, R57, R59, R61, R62, R63, R67, R68, R69, R70, R71, R73, R75, R76, R77, R81, R82, R83, R84, R119, R126, R127, R128, R132, R133, R136, R137, R139, R140, R142	RES., OPTIONAL 0603	
6	0	R102, R103	RES., OPTIONAL 2512	
7	0	R138	RES., OPTIONAL 1206	

### Hardware: For Demo Board Only

1	23	E2-E19, E21-E25	TESTPOINT, TURRET .062"	MILL-MAX, 2308-2-00-80-00-00-07-0
2	2	JP1, JP2	CONN., HEADER, 1x3, 2mm	WURTH ELEKTRONIK, 62000311121
3	2	JP1, JP2	SHUNT, 2mm	WURTH ELEKTRONIK, 60800213421
4	4	J1, J2, J3, J4	STUD, TEST PIN	PEM, KFH-032-10
5	8	J1, J2, J3, J4 (x2)	NUT, BRASS 10-32	ANY, #10-32M/S
6	4	J1, J2, J3, J4	RING, LUG #10	KEYSTONE, 8205
7	4	J1, J2, J3, J4	WASHER, TIN PLATED BRASS	ANY, #10
8	2	J5, J6	JACK, BANANA	KEYSTONE, 575-4
9	1	J7	CONN HEADER 12POS 2MM STR DL PCB	FCI, 98414-G06-12ULF
10	2	J10, J11	CONN, BNC, 5PINS	CONNEX, 112404
11	1	J12	CONN RECEIPT 2MM DUAL R/A 14POS (F)	SULLINS, NPPN072FJFN-RC
12	1	J13	HEADER, 14POS 2MM R/A GOLD (M)	MOLEX, 87760-1416
13	1	J14	HEADER, 4 PINS, SHROUDED	HIROSE, DF3A-4P-2DSA
14	2	SW1, SW2	SWITCH, SLIDE DPDT 300MA 6V	C&K., JS202011CQN
15	4	(STAND-OFF)	STAND-OFF, NYLON 0.50" TALL, SNAP ON	WURTH ELEKTRONIK, 702935000
16	1		FAB, PRINTED CIRCUIT BOARD	DEMO CIRCUIT 2143A
17	2		STENCIL (TOP AND BOTTOM)	STENCIL DC2143A

# DEMO MANUAL DC2143A-C

## SCHEMATIC DIAGRAM

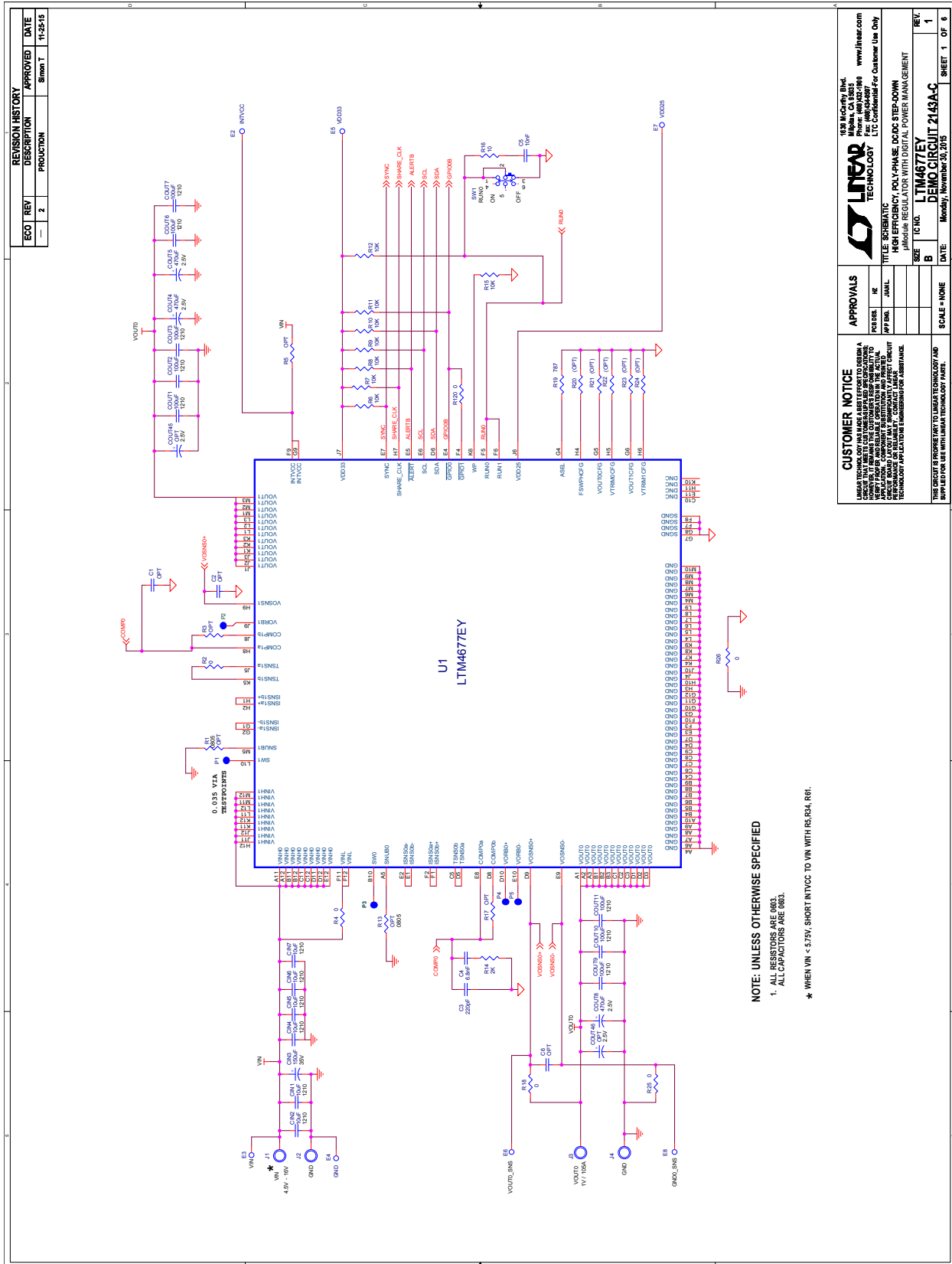

SCHEMATIC DIAGRAM

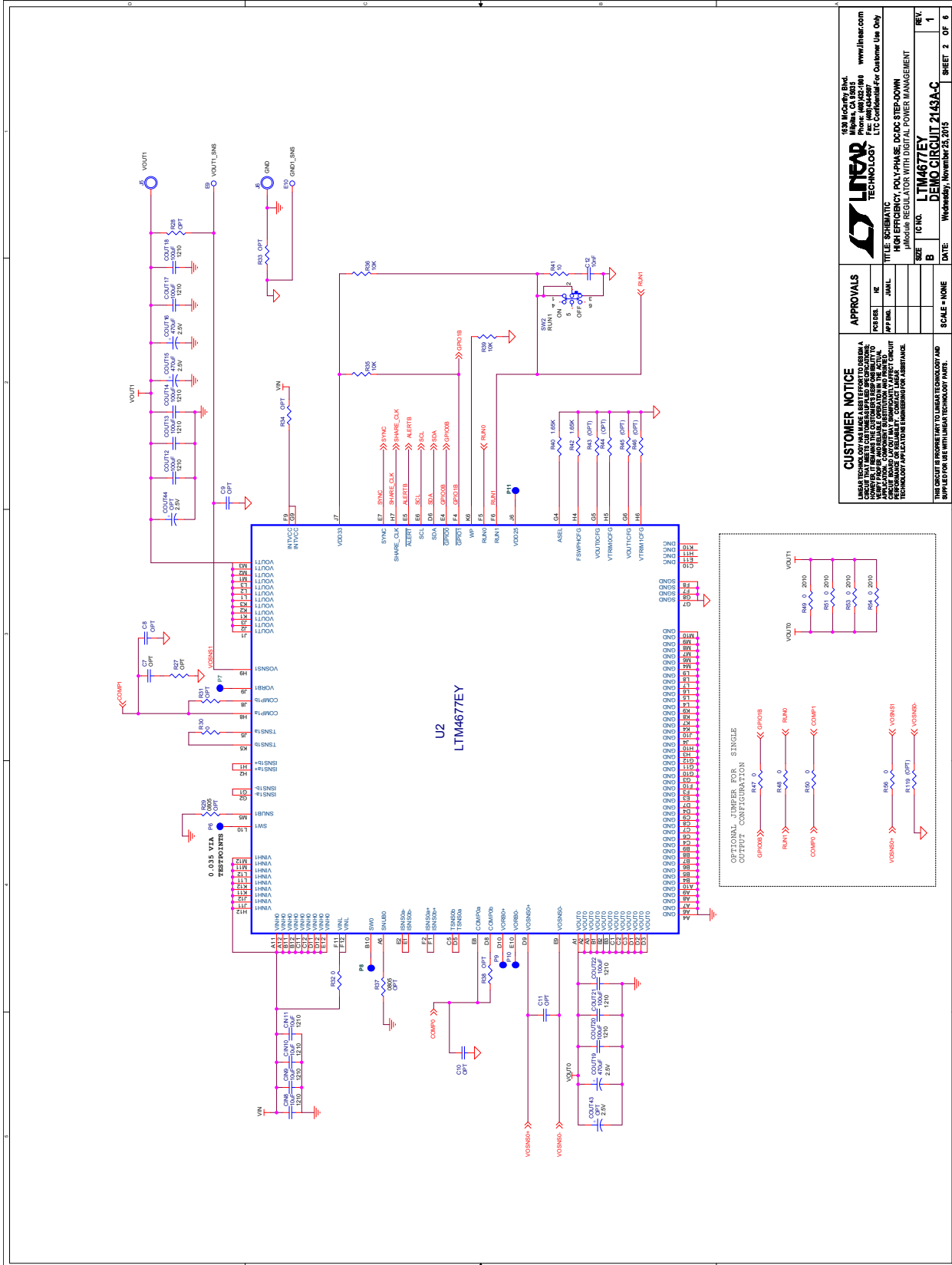

**CUSTOMER NOTICE**  
 LINEAR TECHNOLOGY HAS MADE A BEST EFFORT TO OBTAIN A CORRECT AND COMPLETE SCHEMATIC AND BOM FOR THIS DEMO MANUAL. HOWEVER, THE SCHEMATIC AND BOM ARE PROVIDED AS A GUIDE ONLY. CUSTOMER MUST VERIFY THE SCHEMATIC AND BOM AGAINST THE ACTUAL HARDWARE AND CONTACT LINEAR TECHNOLOGY FOR ASSISTANCE IN ANY APPLICATIONS OR QUESTIONS REGARDING THIS DEMO MANUAL.

**APPROVALS**

DESIGNER	RE
APPRAISER	JMIL

**SCALE** = NONE

**SIZE** = B

**IC NO.** = LTM4677EY

**DATE** = Wednesday, November 25, 2015

**DEMO CIRCUIT 2143A-C**

**SHEET 2 OF 6**

1930 Industry Blvd.  
 Milpitas, CA 95035  
 Tel: 415.964.8800  
 Fax: 415.964.8807  
 www.linear.com

**LINEAR TECHNOLOGY**

µModule, REGULATOR WITH DIGITAL POWER MANAGEMENT  
 HIGH EFFICIENCY, POLY-PHASE, DCDC STEP-DOWN

# DEMO MANUAL DC2143A-C

## SCHEMATIC DIAGRAM

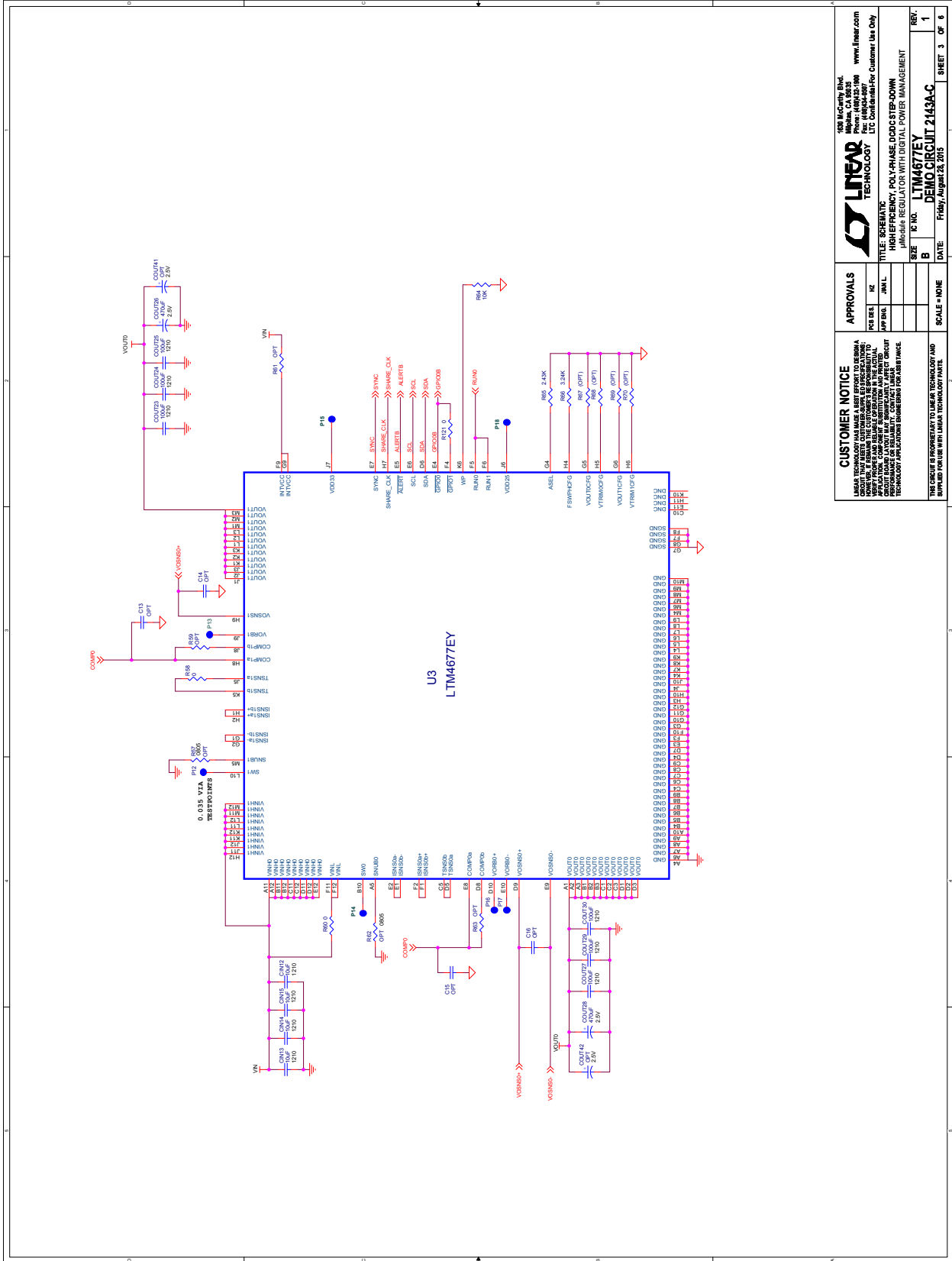

**CUSTOMER NOTICE**  
 LINEAR TECHNOLOGY HAS MADE A BEST EFFORT TO DESIGN A CIRCUIT THAT MEETS THE SPECIFICATIONS AND PERFORMANCE CHARACTERISTICS OF THE IC. THE USER MUST VERIFY THAT THE CIRCUIT MEETS THE SPECIFICATIONS AND PERFORMANCE CHARACTERISTICS OF THE IC IN THE APPLICATION. THE USER MUST VERIFY THAT THE CIRCUIT MEETS THE SPECIFICATIONS AND PERFORMANCE CHARACTERISTICS OF THE IC IN THE APPLICATION. THE USER MUST VERIFY THAT THE CIRCUIT MEETS THE SPECIFICATIONS AND PERFORMANCE CHARACTERISTICS OF THE IC IN THE APPLICATION.

**APPROVALS**

DESIGNER	DATE
CHECKED	DATE
APP'D	DATE

SCALE = NONE

REV. 1

DATE: Friday, August 28, 2015

SHEET 3 OF 6

1628 McCarty Blvd.  
 Phoenix, CA 95028  
 Tel: (408) 291-5000  
 Fax: (408) 291-5007  
 www.linear.com  
 LTM4677EY  
 HIGH-FREQUENCY, POLY-PHASE, DCM STEP-DOWN  
 μMODULE REGULATOR WITH DIGITAL POWER MANAGEMENT



SCHEMATIC DIAGRAM

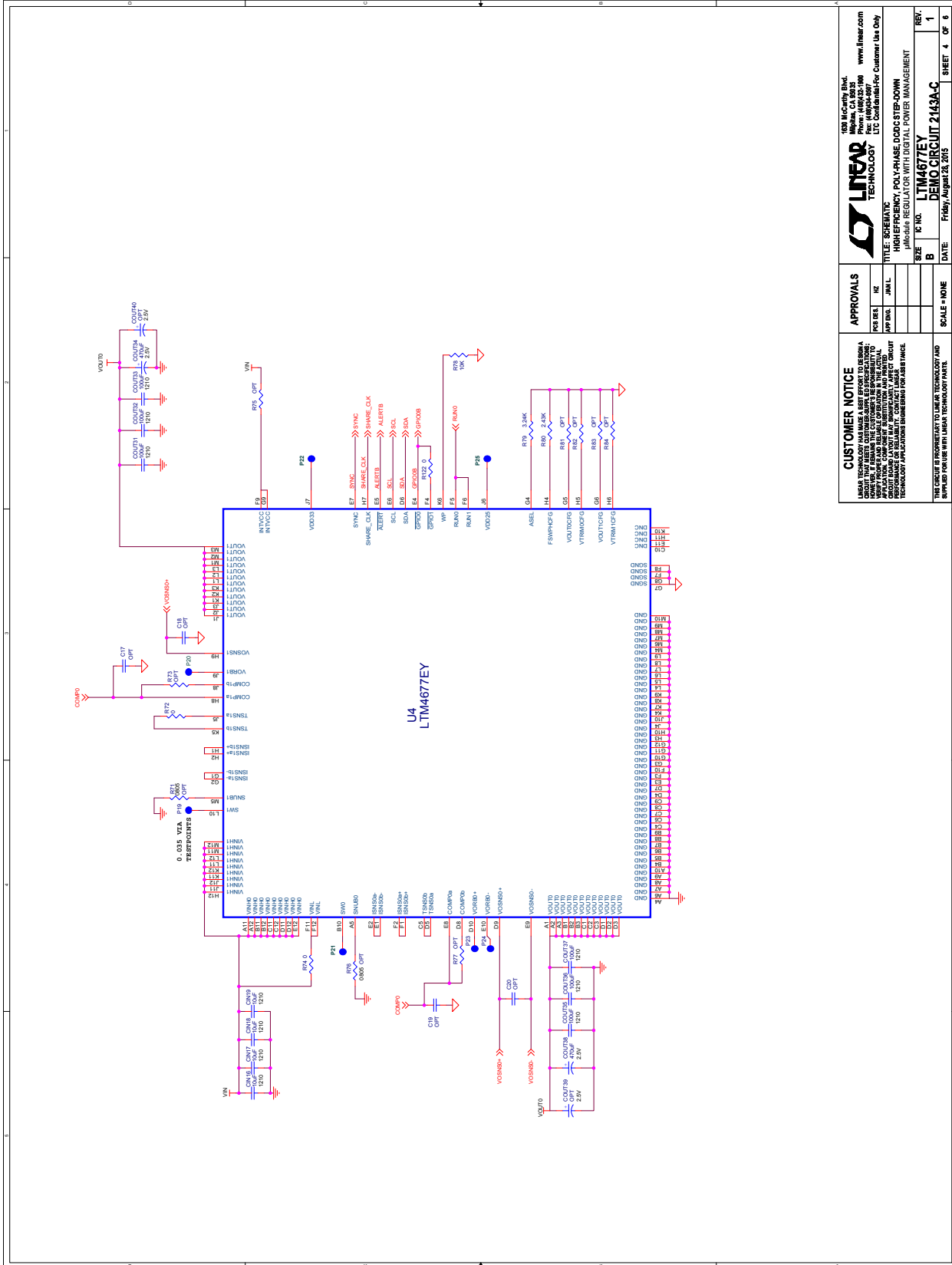

**CUSTOMER NOTICE**  
 LINEAR TECHNOLOGY MAKES A BEST EFFORT TO DESIGN A CIRCUIT THAT WILL OPERATE AS DESCRIBED IN THE DEMO MANUAL. HOWEVER, THE USER MUST VERIFY THE ACTUAL PERFORMANCE OF THE CIRCUIT UNDER ALL OPERATING CONDITIONS. LINEAR TECHNOLOGY ASSUMES NO LIABILITY FOR USER DAMAGE TO PROPERTY OR PERSONS ARISING FROM THE USE OF THIS CIRCUIT.

**APPROVALS**

DESIGNER	CHK
APP'N	APR'N
SCALE	SCALE
SCALE	SCALE

DATE: Friday, August 28, 2015

IC NO. **LTM4677EY**

DEMO CIRCUIT 2143A-C

REVISIONS

REV.	1
DATE	Friday, August 28, 2015
SHEET	4 OF 6



**SCHEMATIC DIAGRAM**

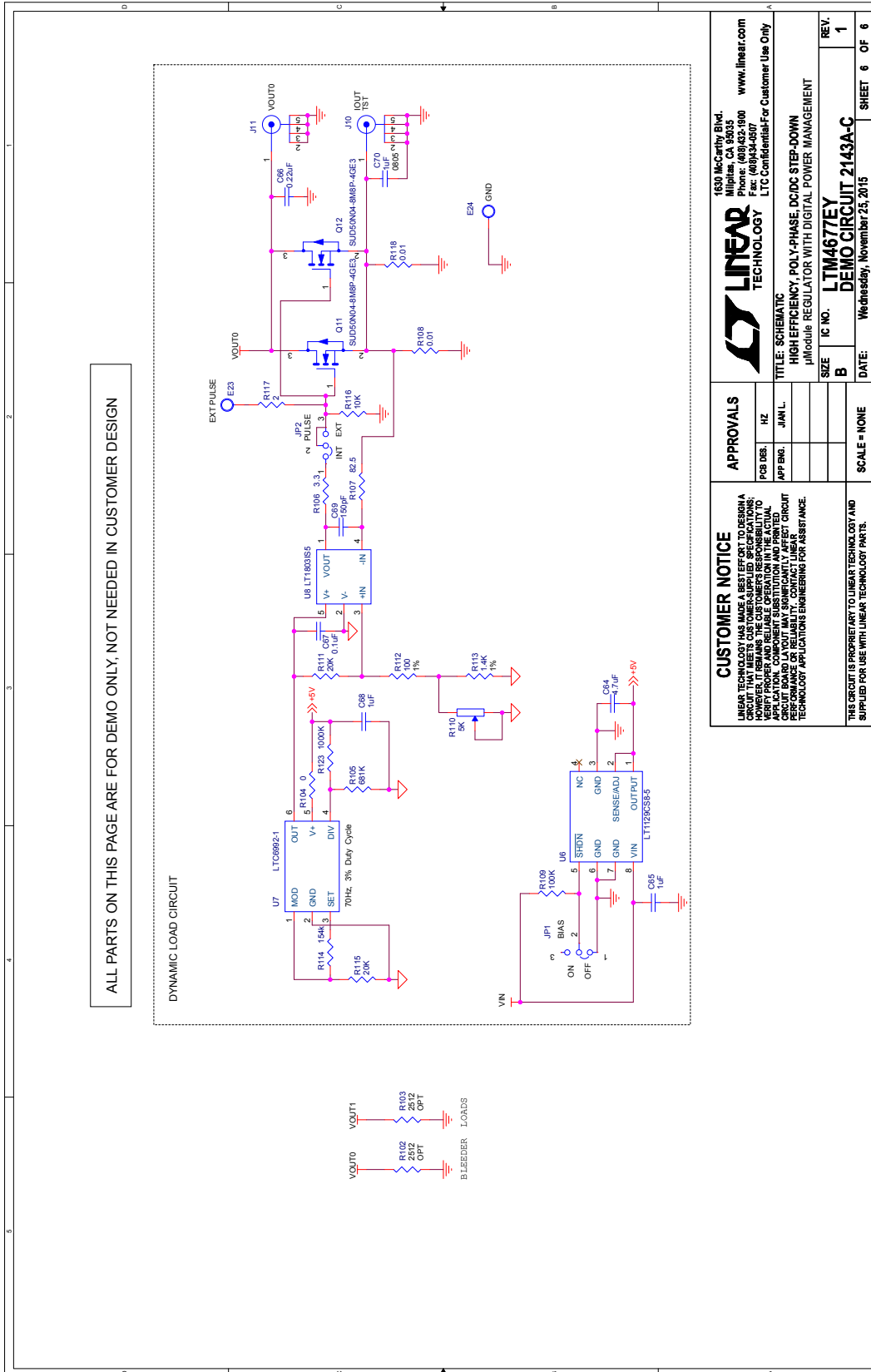

<b>APPROVALS</b>		<p>1830 McCarthy Blvd. Milpitas, CA 95035 Phone: (408)432-8900 www.linear.com Fax: (408)434-4507 LTC Confidential-For Customer Use Only</p>
FCS DES.	HZ	
TITLE: SCHEMATIC		HIGH EFFICIENCY, POLY-PHASE, DC/DC STEP-DOWN μModule REGULATOR WITH DIGITAL POWER MANAGEMENT
APP ENG.	JAN L.	
SCALE = NONE		SIZE IC NO. <b>LTM4677EY</b> <b>DEMO CIRCUIT 2143A-C</b>
SHEET 6 OF 6		
DATE: Wednesday, November 25, 2015		REV. 1
CUSTOMER NOTICE LINEAR TECHNOLOGY HAS MADE A BEST EFFORT TO DESIGN A PROTOTYPE BOARD FOR DEMO PURPOSES ONLY. CUSTOMERS VERIFY PROPER AND RELIABLE OPERATION IN THE ACTUAL CIRCUIT BOARD LAYOUT MAY SIGNIFICANTLY AFFECT CIRCUIT PERFORMANCE OR RELIABILITY. CONTACT LINEAR TECHNOLOGY APPLICATION ENGINEERING FOR ASSISTANCE.		THIS CIRCUIT IS PROPRIETARY TO LINEAR TECHNOLOGY AND SUPPLIED FOR USE WITH LINEAR TECHNOLOGY PARTS.



# DEMO MANUAL DC2143A-C

---

## DEMONSTRATION BOARD IMPORTANT NOTICE

Linear Technology Corporation (LTC) provides the enclosed product(s) under the following **AS IS** conditions:

This demonstration board (DEMO BOARD) kit being sold or provided by Linear Technology is intended for use for **ENGINEERING DEVELOPMENT OR EVALUATION PURPOSES ONLY** and is not provided by LTC for commercial use. As such, the DEMO BOARD herein may not be complete in terms of required design-, marketing-, and/or manufacturing-related protective considerations, including but not limited to product safety measures typically found in finished commercial goods. As a prototype, this product does not fall within the scope of the European Union directive on electromagnetic compatibility and therefore may or may not meet the technical requirements of the directive, or other regulations.

If this evaluation kit does not meet the specifications recited in the DEMO BOARD manual the kit may be returned within 30 days from the date of delivery for a full refund. **THE FOREGOING WARRANTY IS THE EXCLUSIVE WARRANTY MADE BY THE SELLER TO BUYER AND IS IN LIEU OF ALL OTHER WARRANTIES, EXPRESSED, IMPLIED, OR STATUTORY, INCLUDING ANY WARRANTY OF MERCHANTABILITY OR FITNESS FOR ANY PARTICULAR PURPOSE. EXCEPT TO THE EXTENT OF THIS INDEMNITY, NEITHER PARTY SHALL BE LIABLE TO THE OTHER FOR ANY INDIRECT, SPECIAL, INCIDENTAL, OR CONSEQUENTIAL DAMAGES.**

The user assumes all responsibility and liability for proper and safe handling of the goods. Further, the user releases LTC from all claims arising from the handling or use of the goods. Due to the open construction of the product, it is the user's responsibility to take any and all appropriate precautions with regard to electrostatic discharge. Also be aware that the products herein may not be regulatory compliant or agency certified (FCC, UL, CE, etc.).

No License is granted under any patent right or other intellectual property whatsoever. **LTC assumes no liability for applications assistance, customer product design, software performance, or infringement of patents or any other intellectual property rights of any kind.**

LTC currently services a variety of customers for products around the world, and therefore this transaction **is not exclusive**.

**Please read the DEMO BOARD manual prior to handling the product.** Persons handling this product must have electronics training and observe good laboratory practice standards. **Common sense is encouraged.**

This notice contains important safety information about temperatures and voltages. For further safety concerns, please contact a LTC application engineer.

Mailing Address:

Linear Technology  
1630 McCarthy Blvd.  
Milpitas, CA 95035

Copyright © 2004, Linear Technology Corporation