

SPECIFICATION

- Part No. : **MA131.A.LK.002**
- Product Name : MA131 GPS/GLONASS/GALILEO and ISM Band
915MHz
2 in 1 Combination Hercules Screw Mount
(Permanent Thread Mount)
- Features : Stable and High efficiency
4dBi Gain 915MHz (902MHz to 928MHz) ISM Band
-200mm RG316 SMA(M)
GPS/GLONASS/GALILEO -Two Stage 27dB+LNA
- 200mm RG174 SMA(M)
Low profile - Height 28.5mm, diameter 47.8mm
Robust, UV and Vandal resistant PC
housing IP67/IP69K Water Resistant
RoHS Compliant

Photo:



1. Introduction

The MA131 Hercules antenna is a GPS/GLONASS/GALILEO and ISM Band 915MHz combination 2in1 high performance solution for the most reliable asset tracking and remote monitoring. The integrated metal thread-mount allows for external use on vehicles and outdoor assets worldwide.

The 915MHz ISM Band antenna is ideally mounted on a ground-plane but works well also in free-space mounting conditions. The omni-directional gain pattern, with a peak gain of 4dBi when using shorter cable lengths, ensures constant reception and transmission.

The GPS/GLONASS/GALILEO antenna has been optimized to work on both GPS/GALILEO and GLONASS bands, allowing the antenna to see the maximum amount of satellites in the sky and improving tracking accuracy enormously especially in built up areas, such as urban canyons where traditional GPS-only solutions struggle to maintain a lock driving around corners. A front-end SAW filter attenuates any nearby out of band wireless transmissions so the GPS/GALILEO LNA is not driven into compression or damaged.

The Hercules is also prized by the leading wireless device brands globally due to its unique mechanical construction. The compact size and rugged polycarbonate construction, which can withstand direct attack and hazards such as tree-branches, coupled with a waterproof rating of IP67 and IP69K (waterproof against high pressure industrial cleaning from top and bottom sides) are un-matched in the industry.

The standard cable length and connector option is 200mm RG316 and SMA(M). The cable length and connector are customizable. Taoglas supplies low loss extension cables according to your requirement. Maximum cable length should not go beyond 5 meters in order to maintain adequate antenna performance. The Hercules is also available in White. Contact your regional sales office for further information.

2. Specification

ELECTRICAL ISM Band 915MHz						
Operation Frequency (MHz)		915 MHz				
Cable length (M)		0.2	1	2	3	5
In the free space	Average Gain (dB)	-2.91	-3.71	-4.21	-5.01	-6.62
	Efficiency (%)	51.08	42.49	37.86	31.49	21.79
	Peak Gain	0.83	0.04	-0.46	-1.26	-2.86
Cable length (M)		0.2	1	2	3	5
On the 30x30cm ground plane	Average Gain (dB)	-2.94	-3.74	-4.24	-5.04	-6.64
	Efficiency (%)	50.79	42.24	37.65	31.31	21.67
	Peak Gain	4.32	3.52	3.02	2.21	0.62
Max VSWR		2:1				
Max. Return Loss (dB)		-10				
Polarization		Linear				
Impedance		50 Ohms				
Max Input Power		5 Watts				

ELECTRICAL GPS-GLONASS-GALILEO	
Frequency	1574~1606MHz
Impedance	50 ohm
VSWR	2.0 Max
GPS Patch Gain @ Zenith	-1.4dBi Passive Gain @ Zenith
GLONASS Patch Gain @ Zenith	-1.3dBi Passive Gain @ Zenith
Out Band Rejection	fo = 1575.42MHz
	fo ± 30 MHz 5dB Min.
	fo ± 50 MHz 20dB Min.
	fo ± 100 MHz 25dB Min.
Input Voltage	Typ. 2.5~5.5V
Total Gain @ Zenith	27dB typical at 3.0V
Current Consumption	10mA typical at 3.0V
Noise Figure	1.3dB typical

MECHANICAL	
Dimension (mm)	Height = 28.5 mm and Diameter = 47.8 mm
Cable length	200mm RG316 of ISM Band antenna – Fully Customizable 200mm RG174 of GPS/GLONASS antenna –Fully Customizable
Connector	Both are SMA(M)ST – Fully Customizable
Casing	UV Resistant PC
Base and Thread	Nickel Plated Steel
Thread Diameter	18 mm
Weather proof gasket	CR4305
Sealant	Rubber Stopper
Weight	140g (200mm cable length)
ENVIRONMENTAL RATINGS	
Protection	IP67 & IP69K
Corrosion	5% NaCl for 48hrs - Nickel plated zinc base and thread
Temperature Range	-40°C to +85°C
Thermal Shock	100 cycles -40°C to +85°C
Humidity	Non-condensing 65°C 95% RH
Shock (Drop Test)	1m drop on concrete 6 axes
Cable Pull	8 Kgf
Recommended Torque Setting for Mounting	24.5N·m
Maximum Torque Setting for Mounting	29.5N·m

3. Antenna Characteristics

3.1 Test Setup

MA.131.A.LK.002 antenna was tested with R&S ZNB-8 network analyzer.

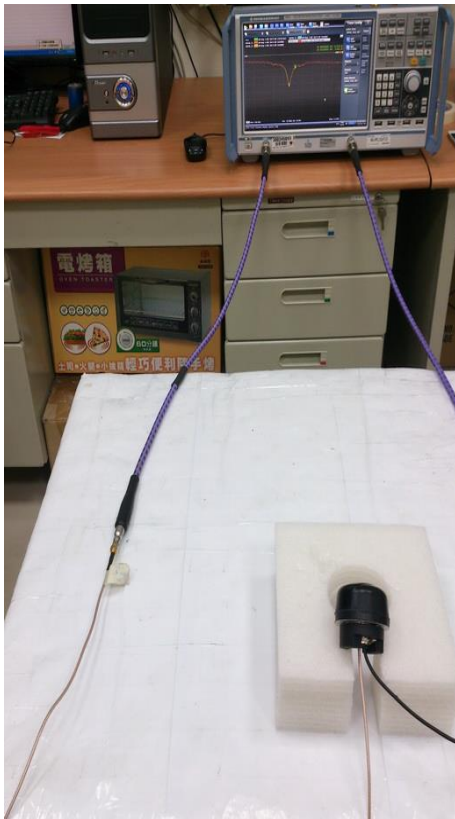

In free space



On 30x30 ground plane

Taoglas measured the antenna with two states - in free space, and mounted on a 30x30cm ground plane

4. 915MHz Antenna

4.1 Return Loss

4.1.1 In free space

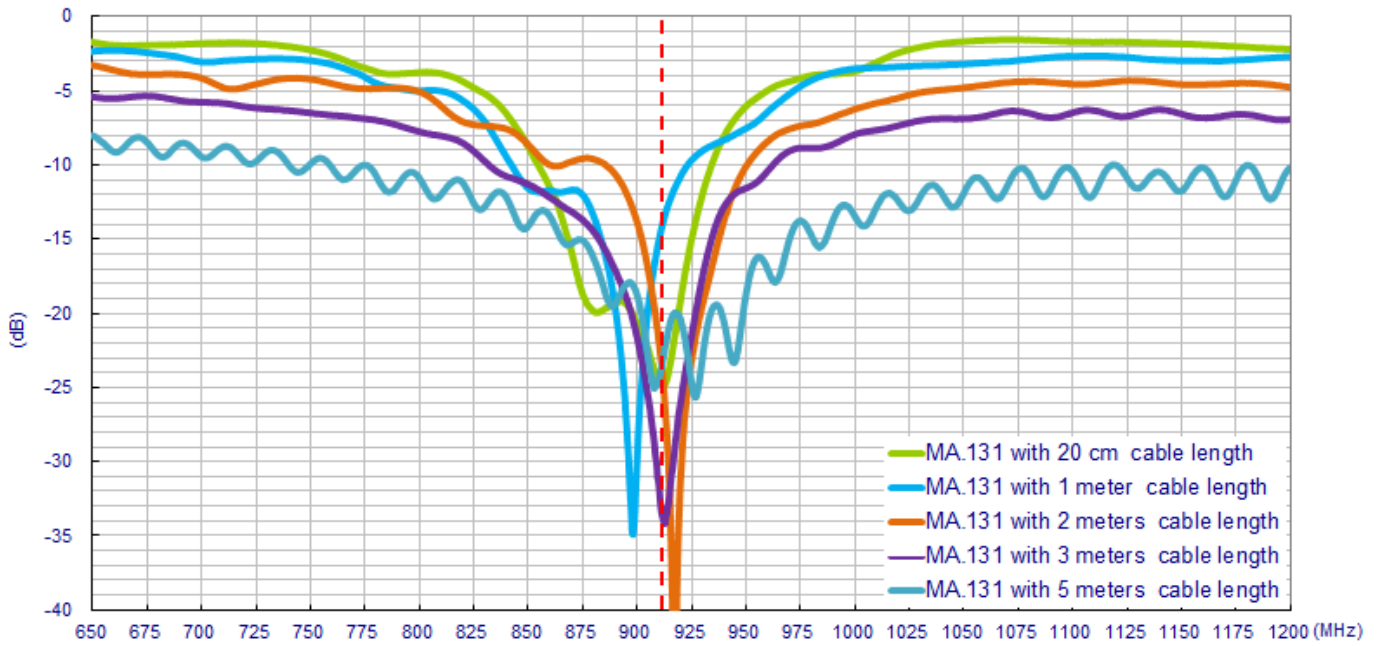

4.1.2 On 30X30cm ground plane

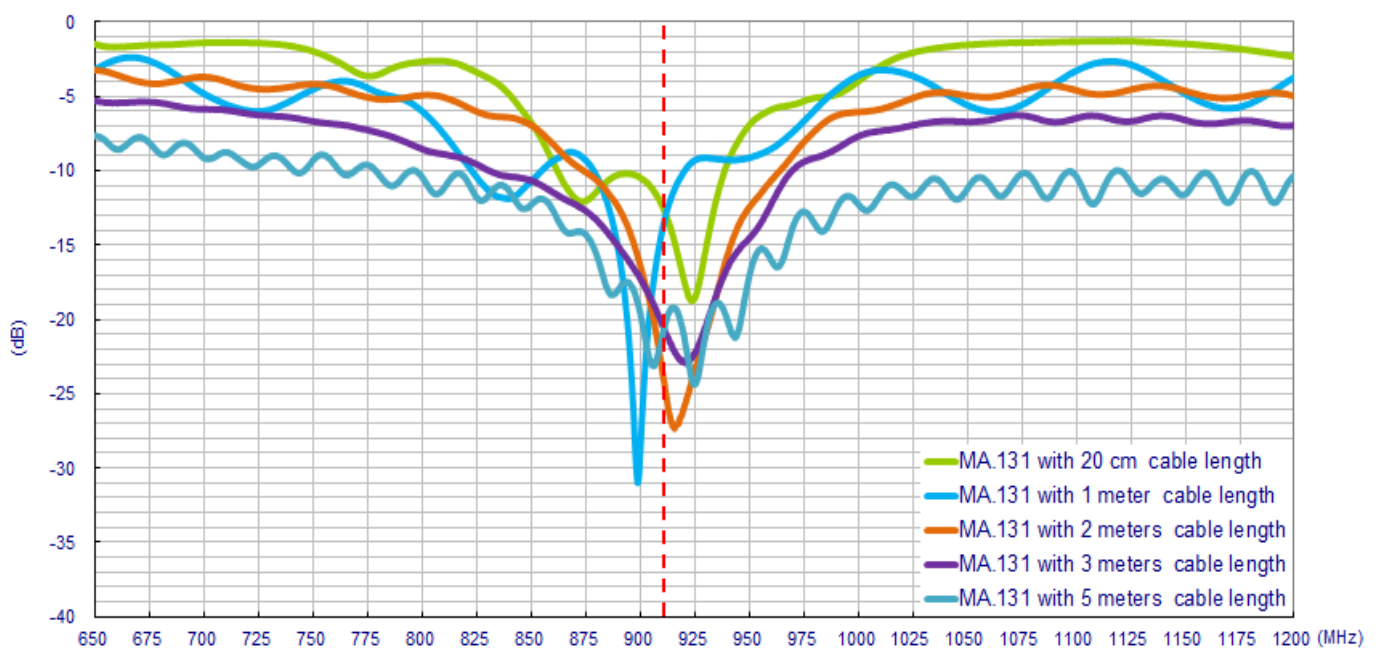

4.2 Average Gain

4.2.1 In free space

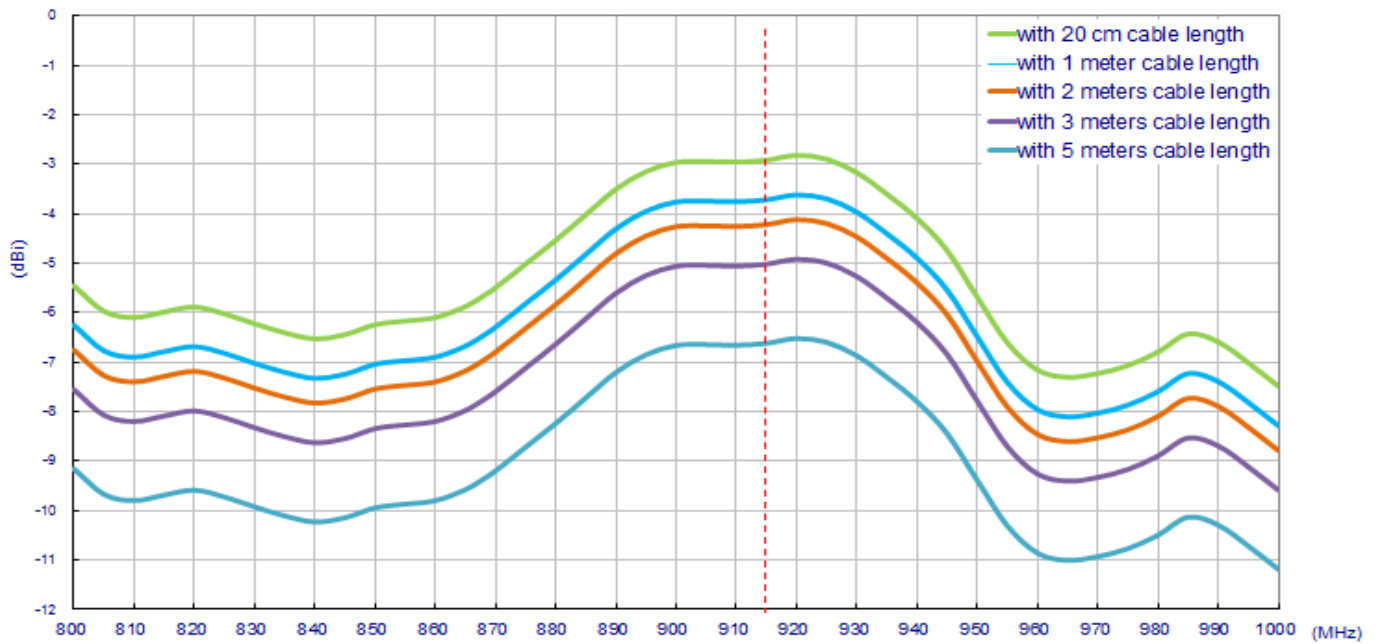

4.2.2 On 30x30cm ground plane

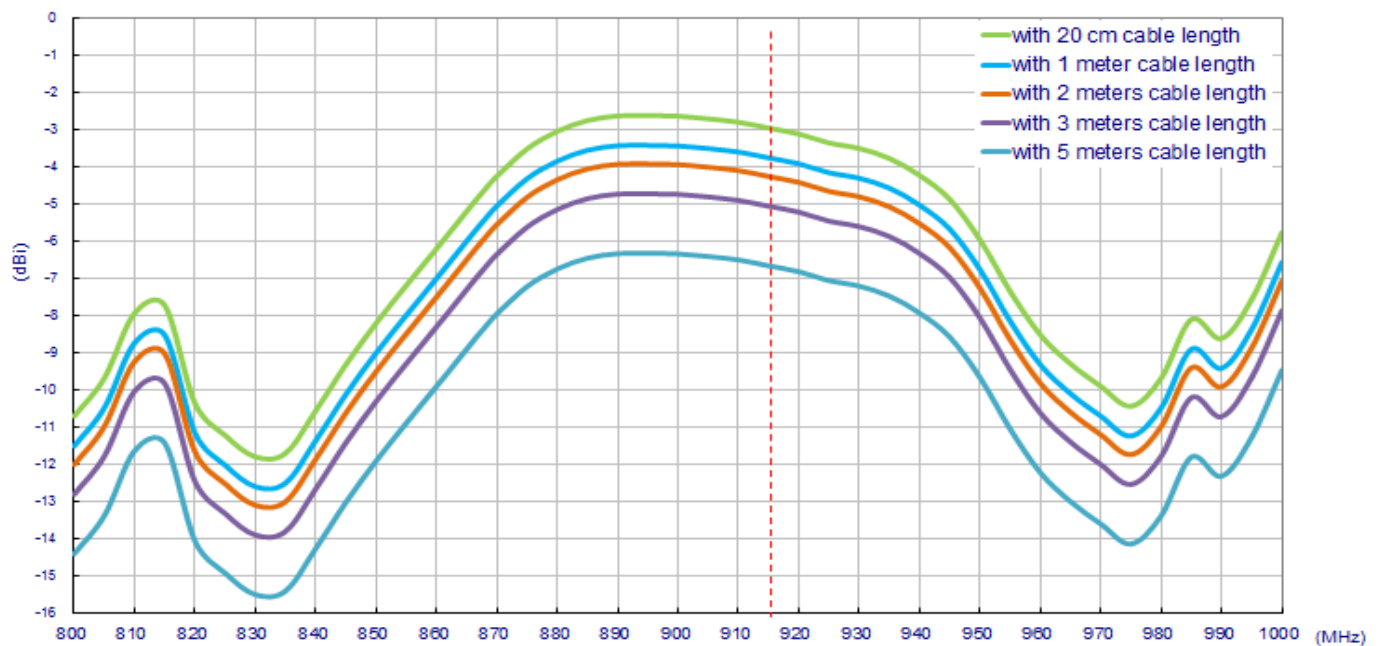

4.3 Efficiency

4.3.1 In free space

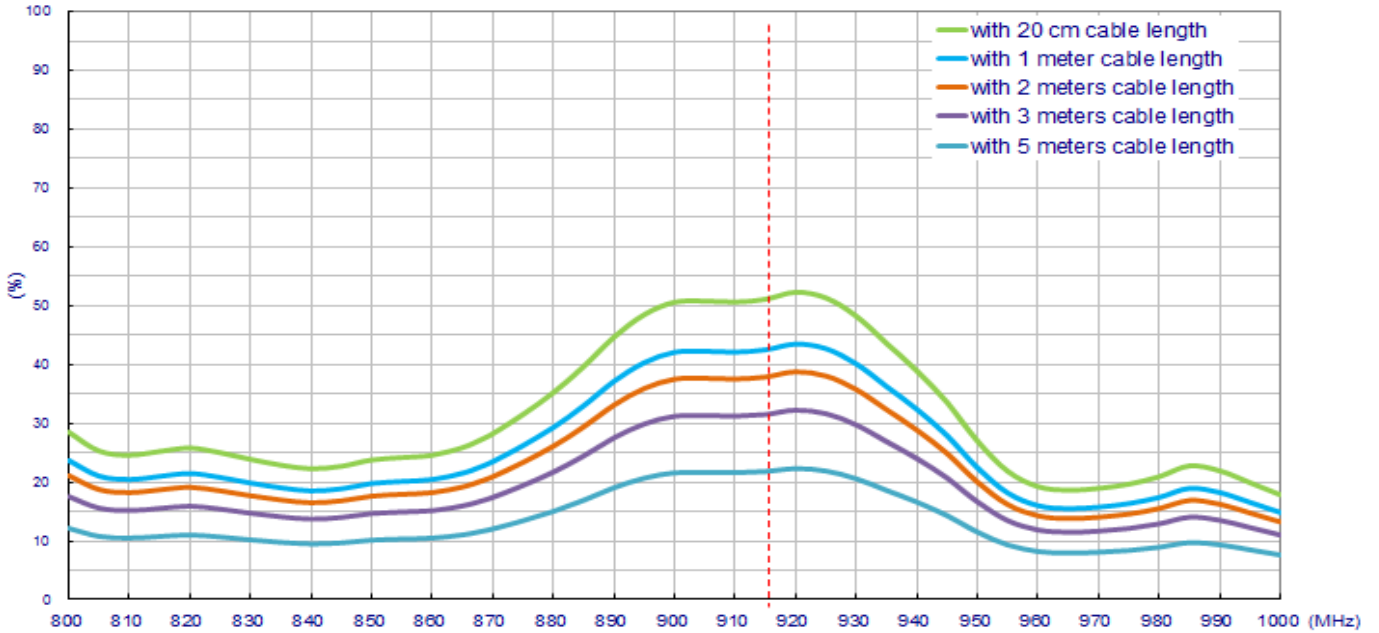

4.3.2 On 30x30cm ground plane

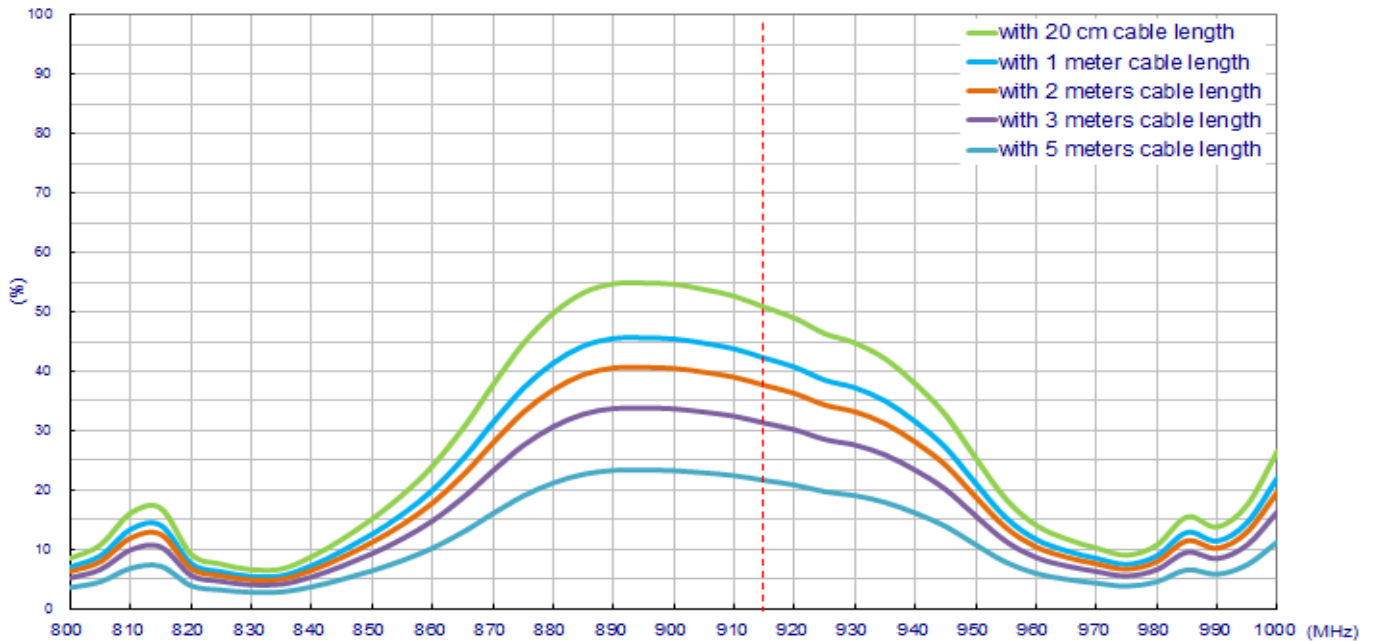

4.4 Peak Gain

4.4.1 In free space

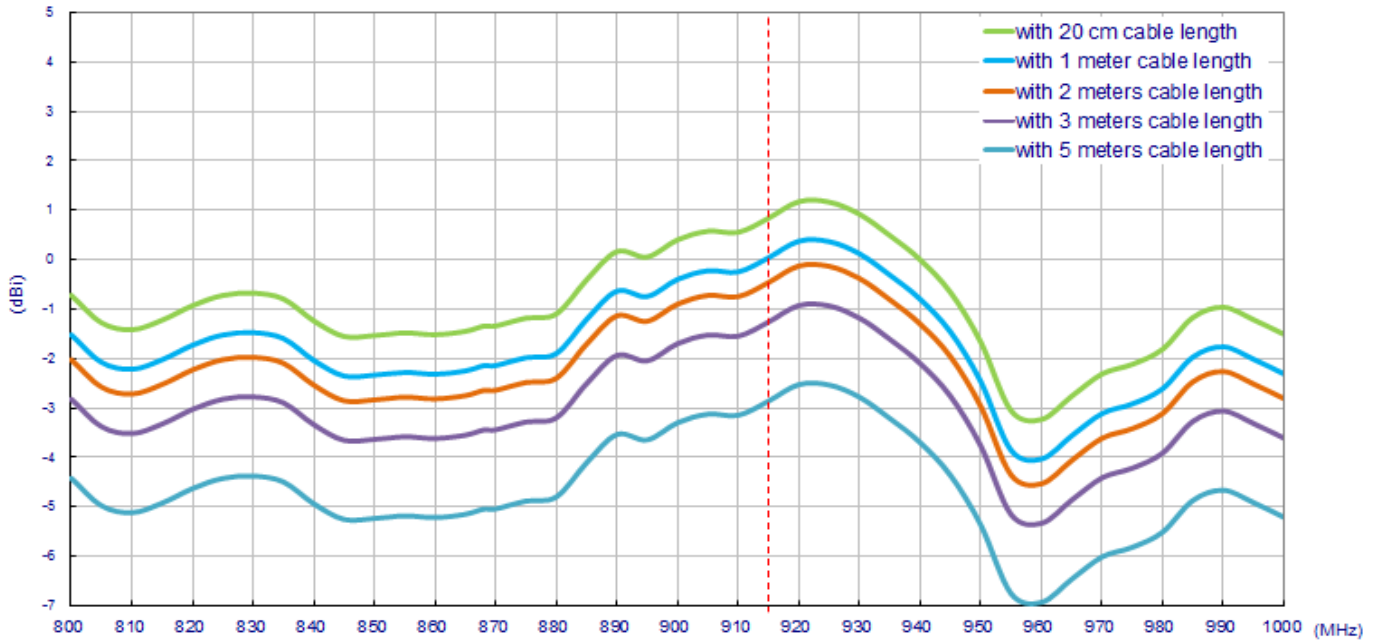

4.4.2 On 30x30cm ground plane

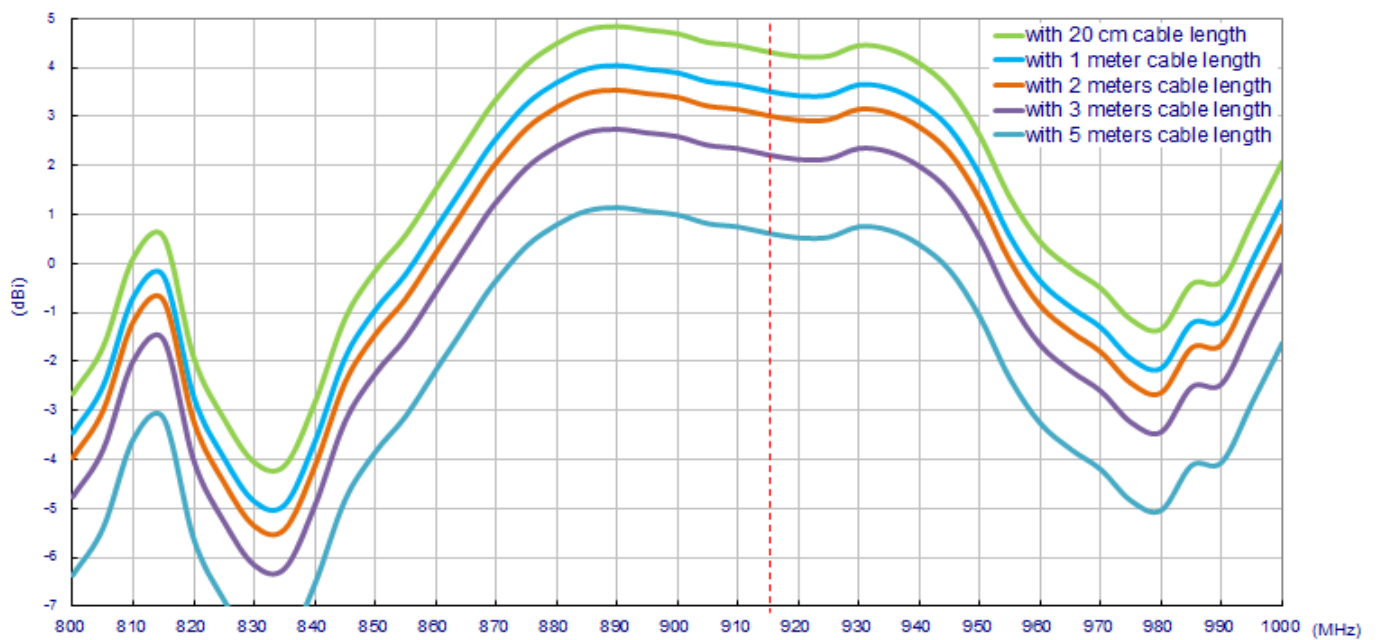

4.5 Antenna Radiation Patterns

4.5.1 Antenna Setup

The antenna radiation pattern test setup is shown below.

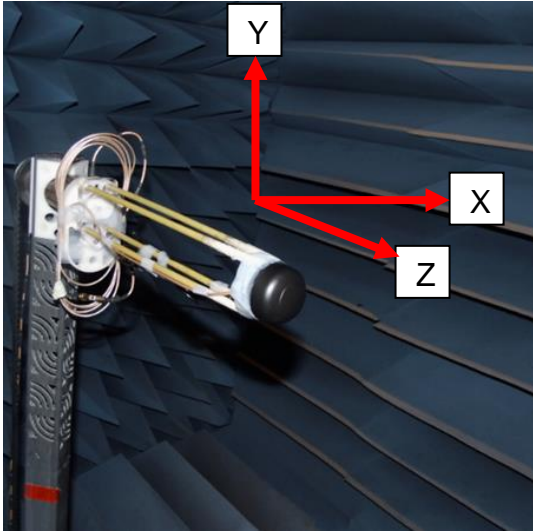

In free space

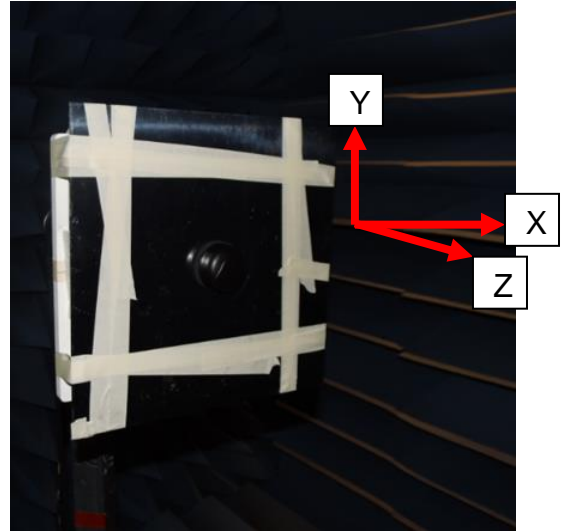

On 30x30 ground plane

4.5.2 Antenna Radiation Patterns In free space XY Plane

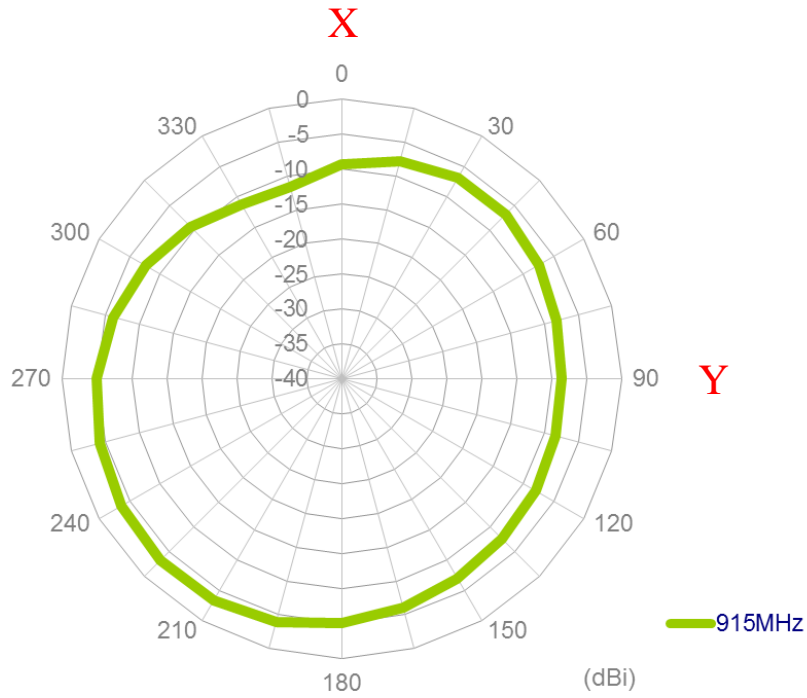

XZ Plane

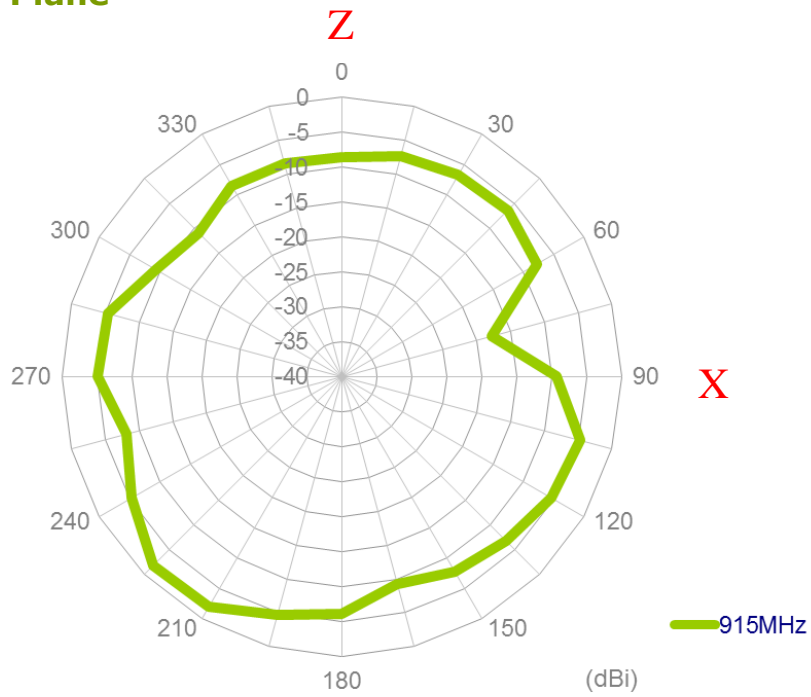

YZ Plane

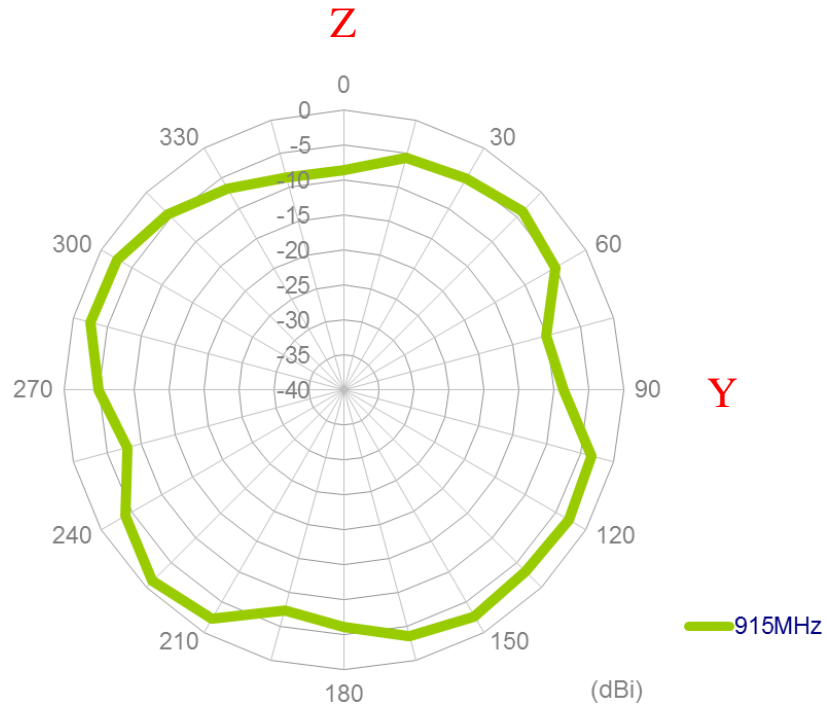

**On the ground plane
XY Plane**

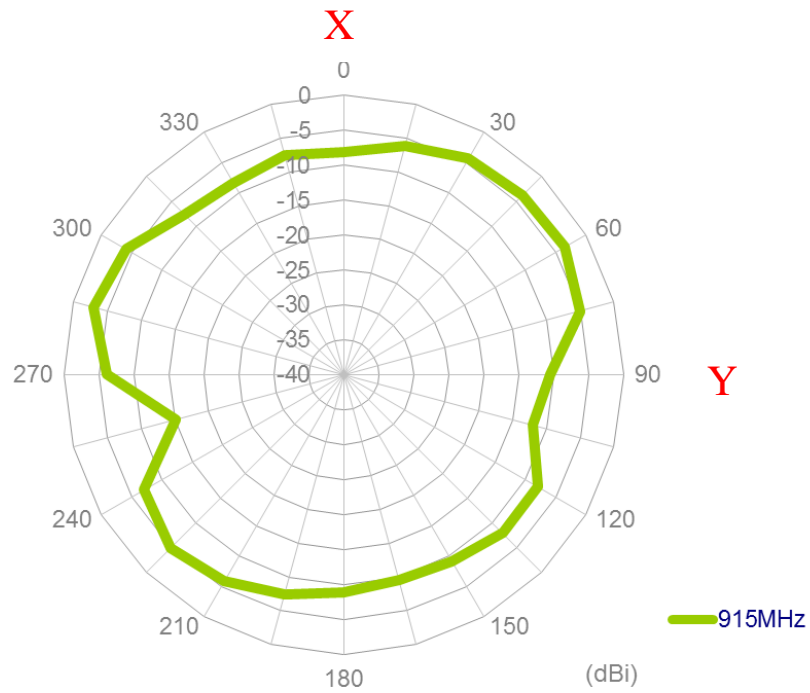

XZ Plane

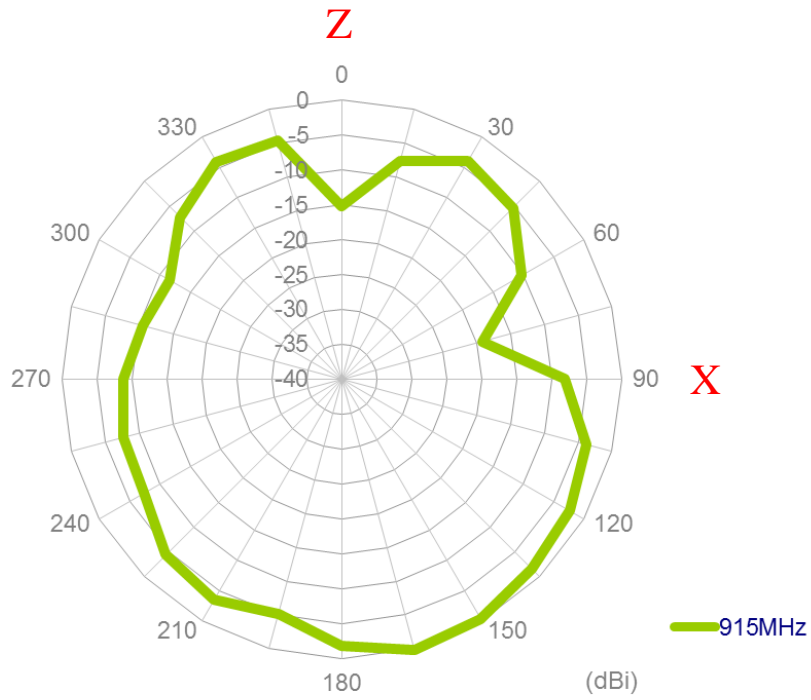

YZ Plane

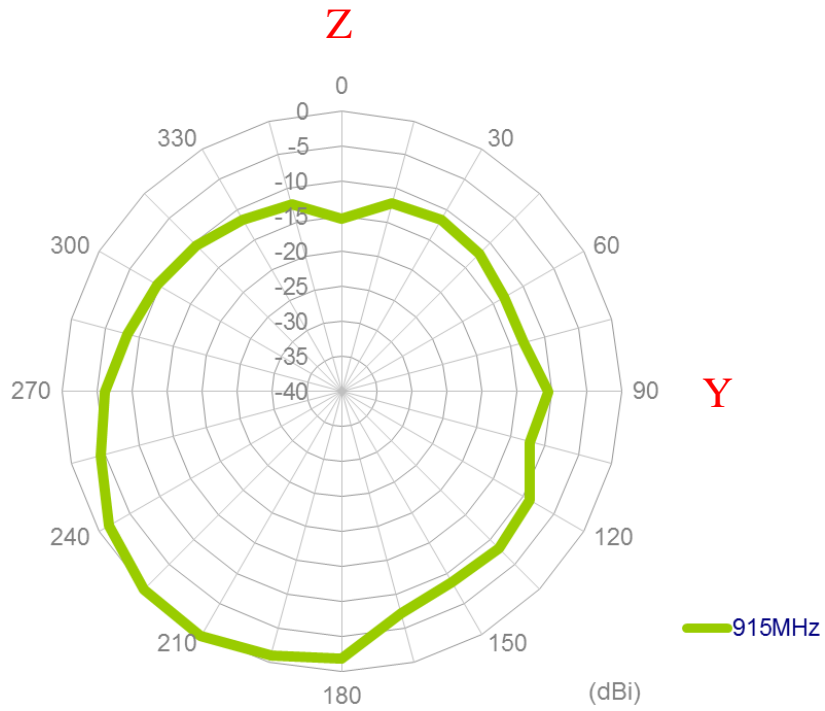

5. GPS-GLONASS-GALILEO Antenna

5.1 System Block Diagram

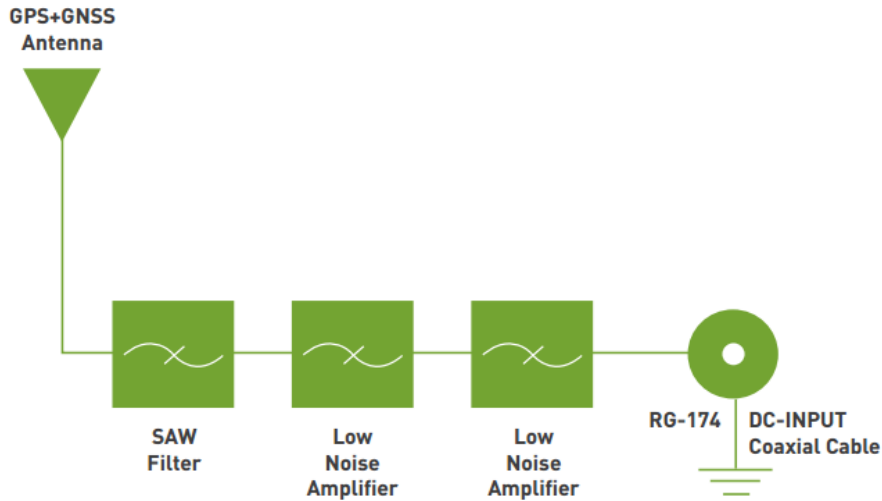

5.2 GPS-GLONASS-GALILEO Passive Antenna Result

5.2.1 Return Loss

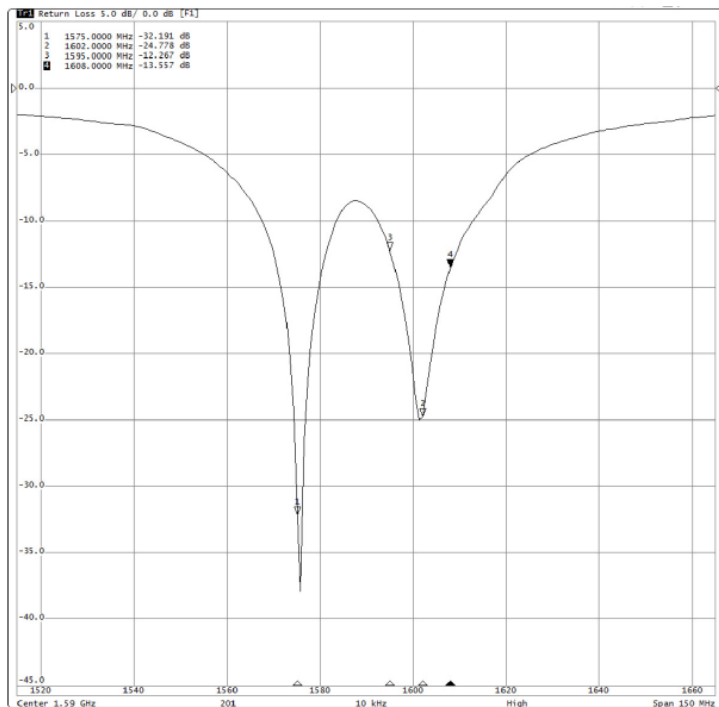

Return Loss : 1575.42 MHz -32.19 dB
 1602.6 MHz -24.77 dB

5.2.2 VSWR

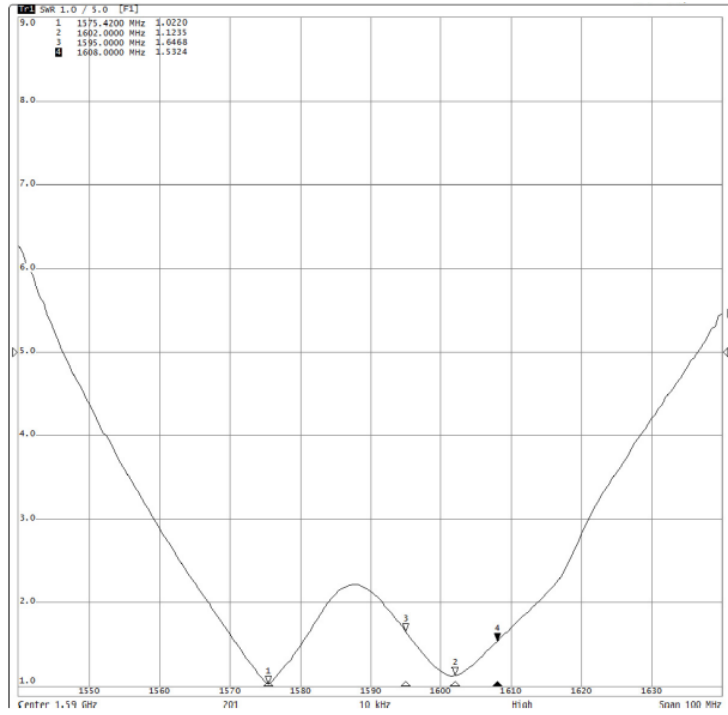

5.2.3 Smith Chart

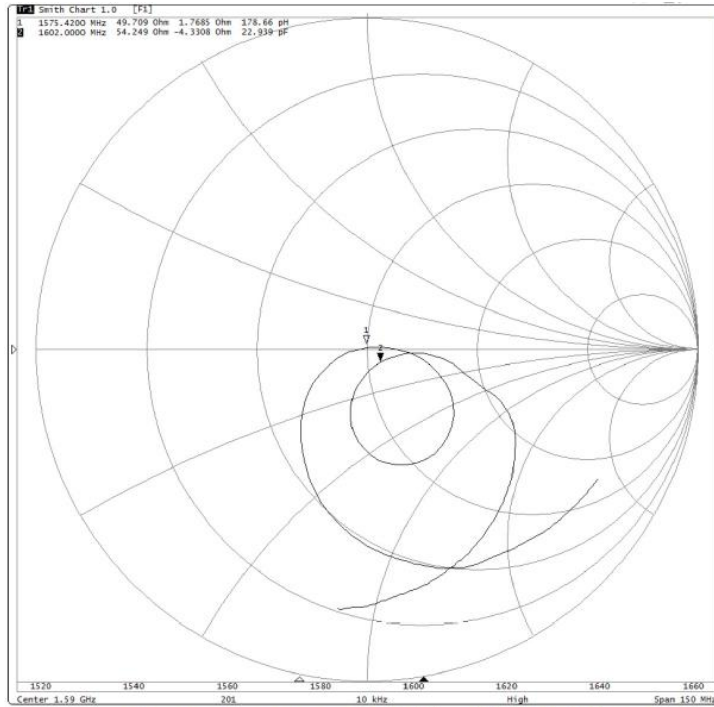

Impedance : 49.70 +j1.76 Ohm

Impedance : 54.24 -j4.33 Ohm

5.3 GPS-GLONASS-GALILEO Radiation Patterns

XZ-Plane

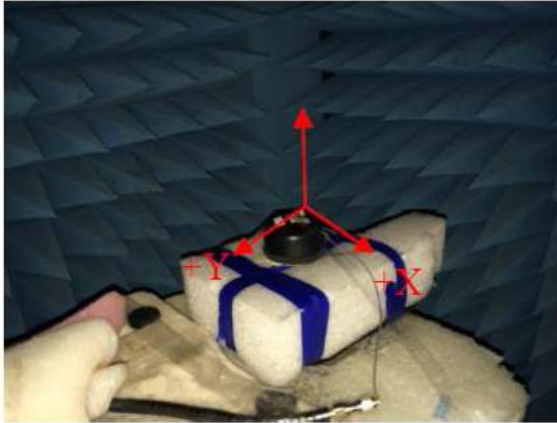

YZ-Plane

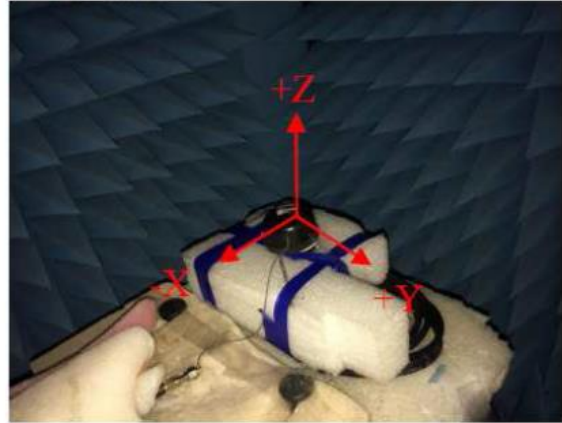

5.3.1.1 1575.42 MHz XZ-Plane

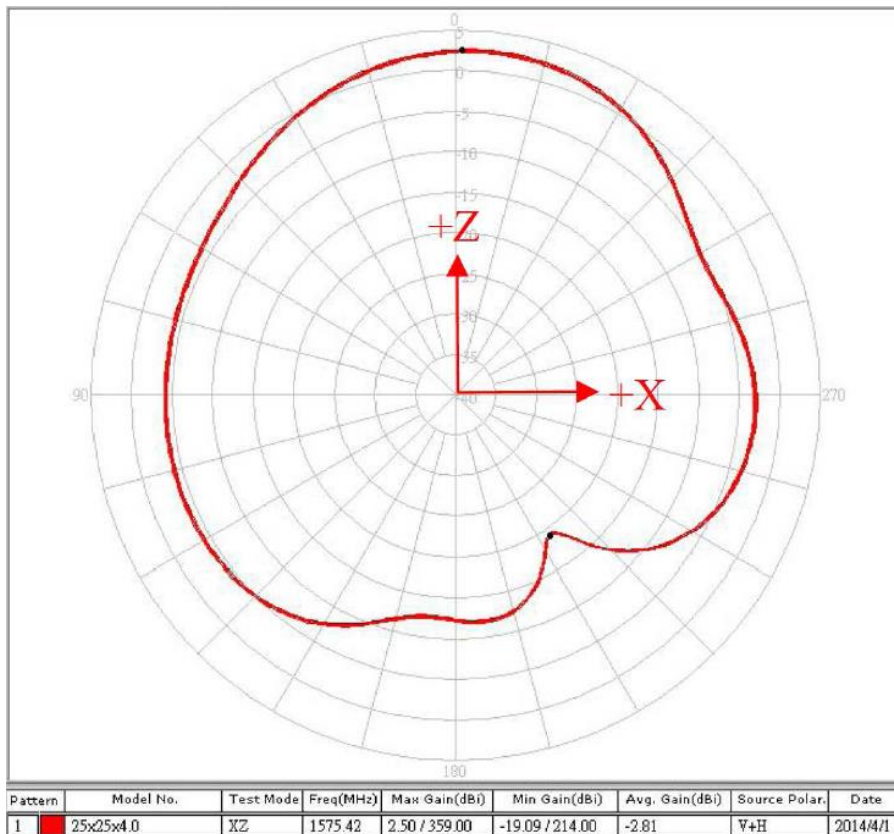

5.3.2 1575.42 MHz YZ-Plane

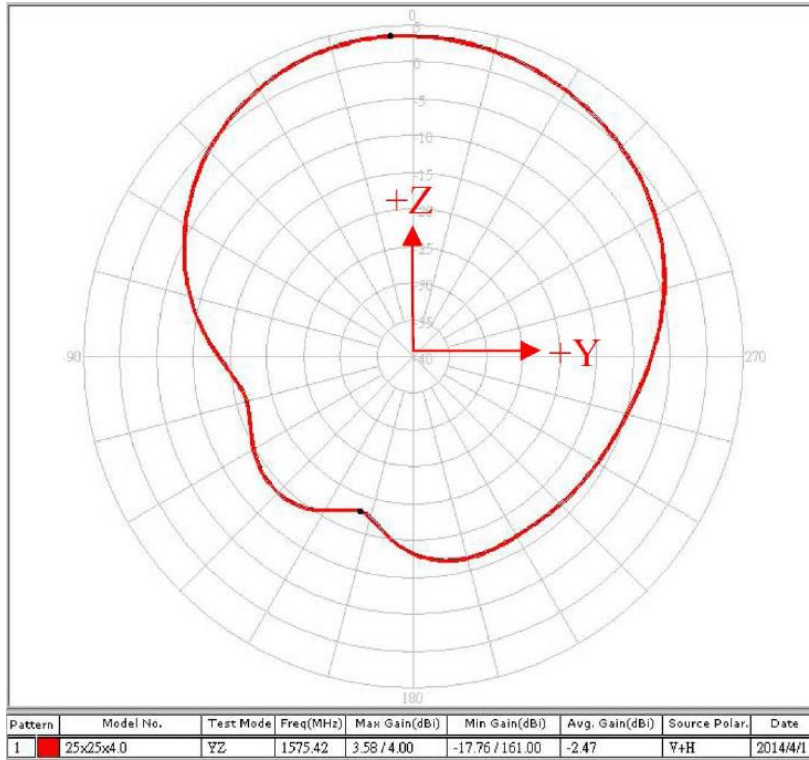

5.3.3 1602 MHz XZ-Plane

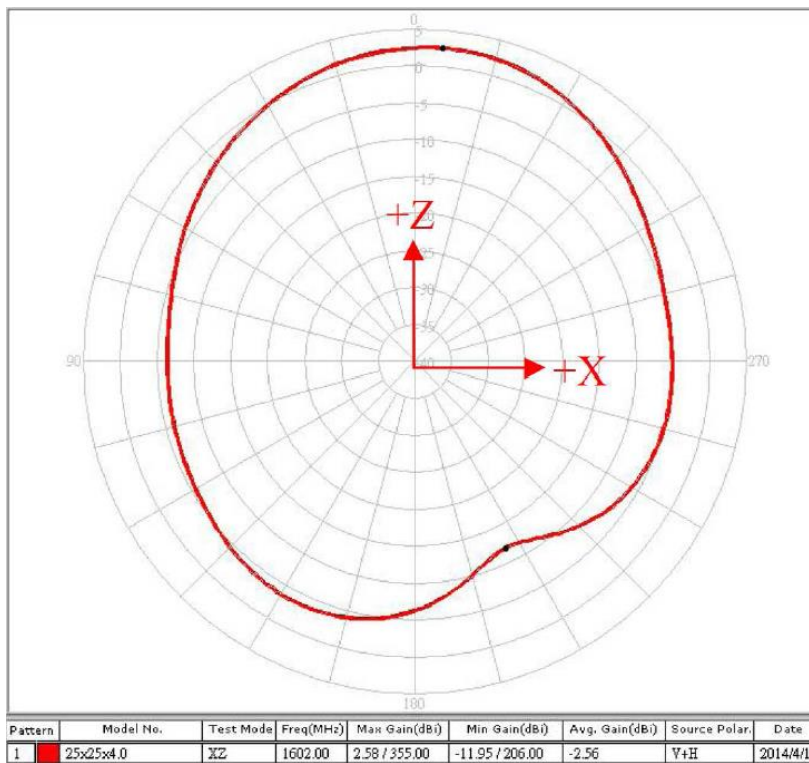

5.3.4 1606 MHz YZ-Plane

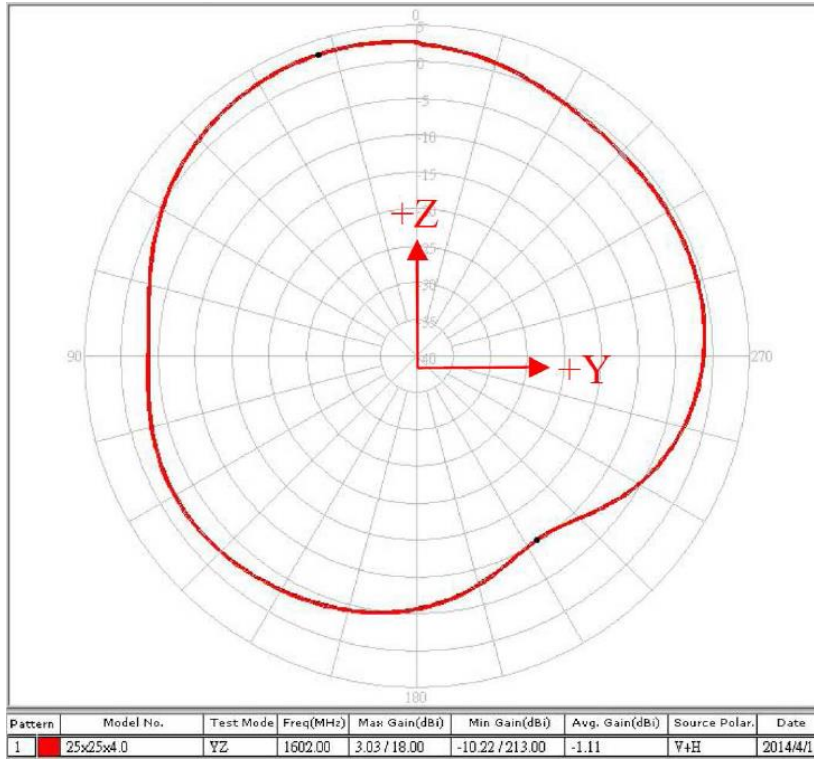

5.4 GPS-GLONASS-GALILEO – Low Noise Amplifier

5.4.1 S21_Gain

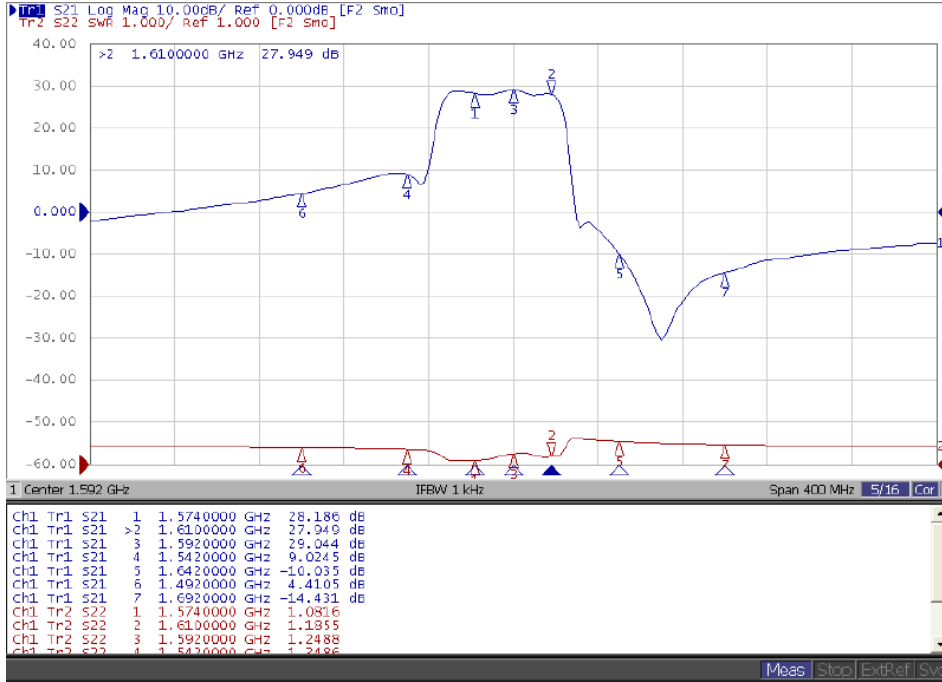

5.4.2 Noise Figure

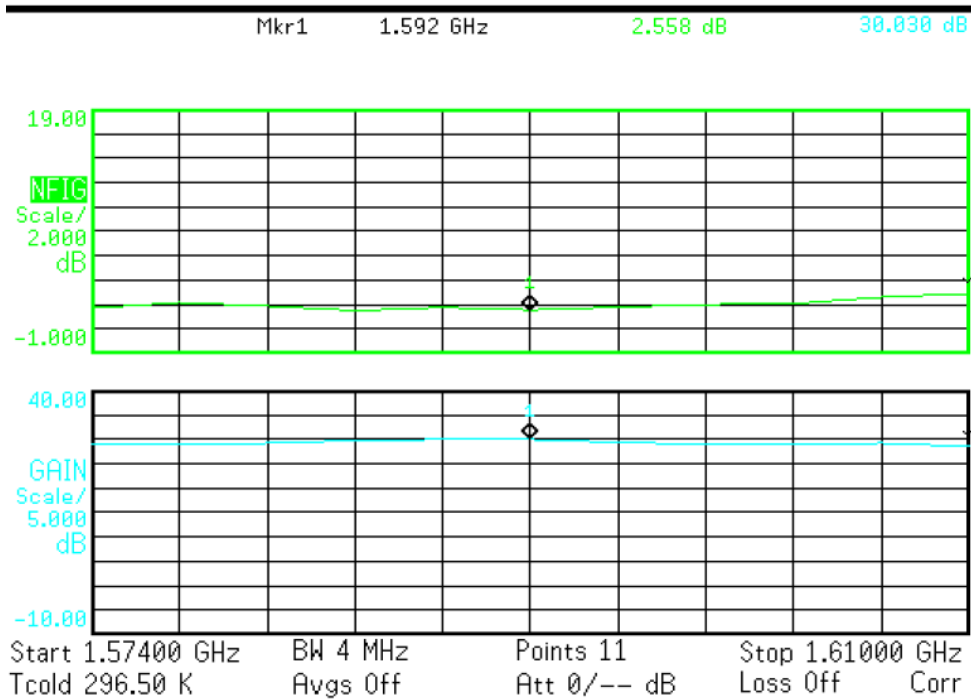

6. Drawing

Top View

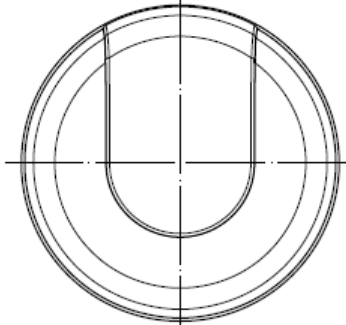

Front View

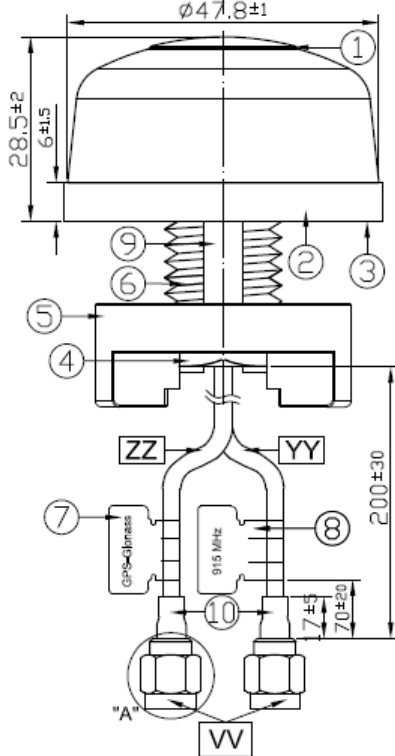

	Name	Material	Finish	QTY
1	Housing	PC	Black	1
2	Closed Cell Foam	CR 4305	Black	1
3	3M Double Adhesive	3M 9448 HK	White LIner	1
4	M18 Inner Nut	Carbon Steel	Ni Plated	1
5	Outer Nut Cover	ABS	Black	1
6	Hercules Metal Base	Zinc alloy	Ni Plated	1
7	GPS-Glonass Label	Coated Paper	Orange	1
8	915 MHz Label	Coated Paper	Olive Drab	1
9	Rubber Stopper	Rubber	Black	1
10	Heat Shrink Tube	PE	Black	2

	Name	Spec	Finish	QTY
VV	Connector Type	SMA(M)ST	Gold	2
YY	Cable Type	RG-316	Brown	1
ZZ	Cable Type	RG-174	Black	1

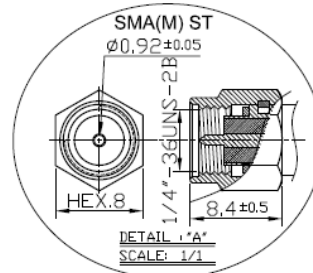

Side View

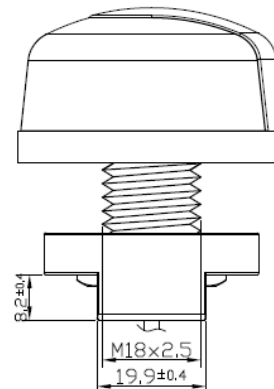

Bottom Thread View

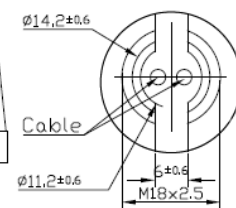

7. Installation

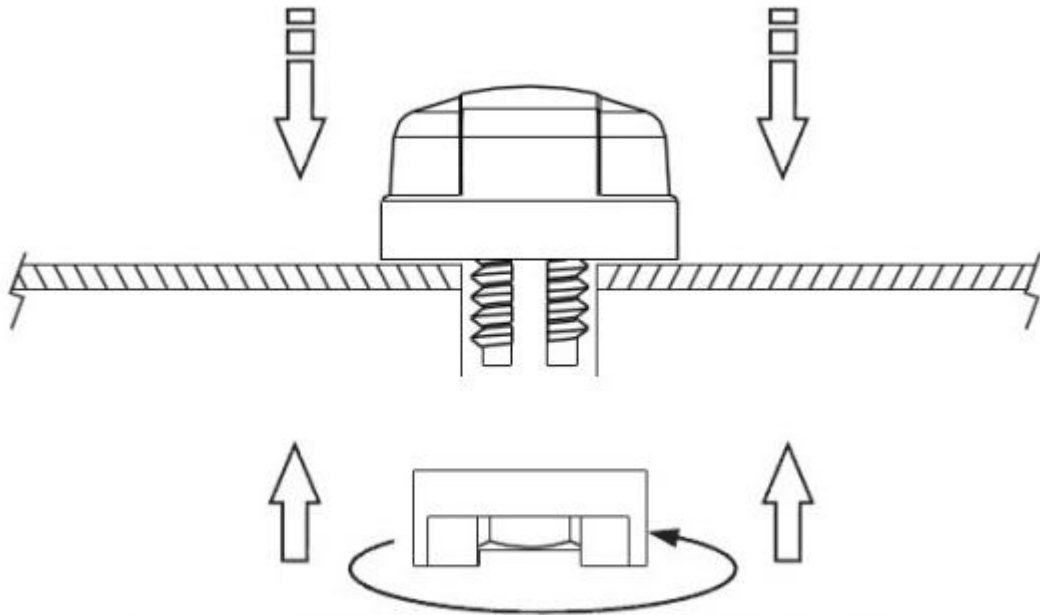

Recommended torque for Mounting is 24.5N·m
Maximum torque for mounting is 29.4N·m

8. Packaging

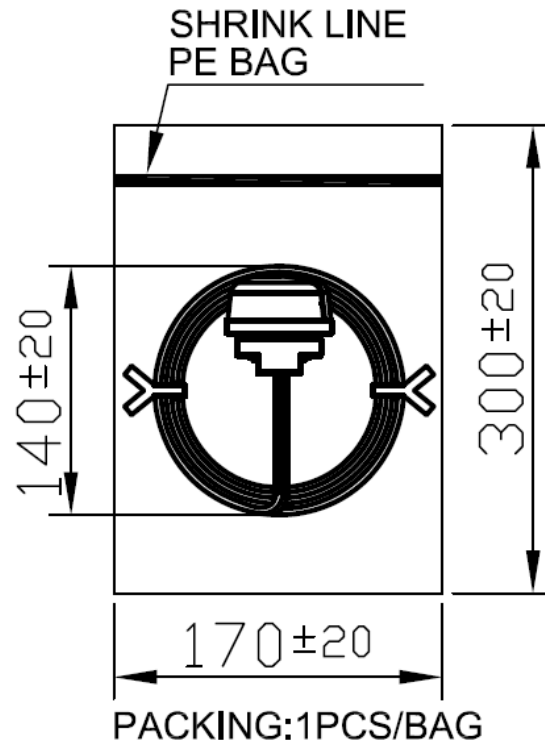

Taoglas makes no warranties based on the accuracy or completeness of the contents of this document and reserves the right to make changes to specifications and product descriptions at any time without notice. Taoglas reserves all rights to this document and the information contained herein.

Reproduction, use or disclosure to third parties without express permission is strictly prohibited.

Copyright © Taoglas Ltd.