

The S-8424A Series is a CMOS IC designed for use in the switching circuits of primary and backup power supplies on a single chip. It consists of two voltage regulators, three voltage detectors, a power supply switch and its controller, as well as other functions.

In addition to the switching function between the primary and backup power supply, the S-8424A Series can provide the micro controllers with three types of voltage detection output signals corresponding to the power supply voltage. Moreover adopting a special sequence for switch control enables the effective use of the backup power supply, making this IC ideal for configuring a backup system.

### ■ Features

- Low power consumption
  - Normal operation: 15  $\mu$ A Max. ( $V_{IN} = 6$  V)
  - Backup: 2.1  $\mu$ A Max.
- Voltage regulator
  - Output voltage tolerance :  $\pm 2$  %
  - Output voltage: Independently selectable in 0.1 V steps in the range of 2.3 V to 5.4 V
- Three built-in voltage detectors (CS,  $\overline{\text{PREEND}}$ ,  $\overline{\text{RESET}}$ )
  - Detection voltage precision:  $\pm 2$  %
  - Detection voltage: Selectable in 0.1 V steps in the range of 2.4 V to 5.3 V (CS voltage detector)
  - Selectable in 0.1 V steps in the range of 1.7 V to 3.4 V ( $\overline{\text{PREEND}}$ ,  $\overline{\text{RESET}}$  voltage detector)
- Switching circuit for primary power supply and backup power supply configurable on one chip
- Efficient use of backup power supply possible
- Special sequence
  - Backup voltage is not output when the primary power supply voltage does not reach the initial voltage at which the switch unit operates.
- Lead-free, Sn 100%, halogen-free<sup>\*1</sup>

\*1. Refer to “**■ Product Name Structure**” for details.

### ■ Packages

- 8-Pin TSSOP
- 8-Pin SON(B)

### ■ Applications

- Video camera recorders
- Still video cameras
- Memory cards
- SRAM backup equipment

■ **Product Name Structure**

**1. Product name**

**(1) 8-Pin TSSOP**

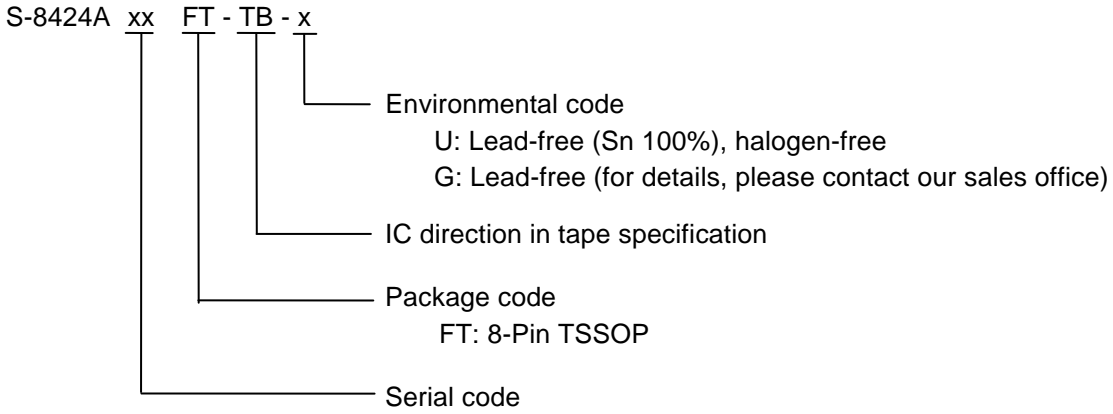

**(2) 8-Pin SON(B)**

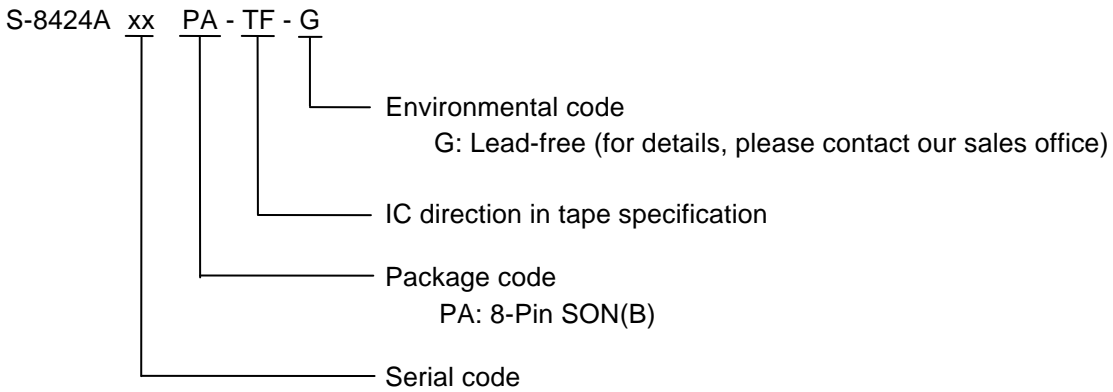

**2. Package**

Package Name		Drawing Code		
		Package	Tape	Reel
8-Pin TSSOP	Environmental code = G	FT008-A-P-SD	FT008-E-C-SD	FT008-E-R-SD
	Environmental code = U	FT008-A-P-SD	FT008-E-C-SD	FT008-E-R-S1
8-Pin SON(B)		PA008-B-P-SD	PA008-B-C-SD	PA008-B-R-SD

### 3. Product name list

Type \ Part No.	Package	Output Voltage (V)		CS Voltage (V)		RESET Voltage (V)		PREEND Voltage (V)		Switch Voltage (V)
		V <sub>RO</sub>	V <sub>OUT</sub>	-V <sub>DET1</sub>	+V <sub>DET1</sub>	-V <sub>DET2</sub>	+V <sub>DET2</sub>	-V <sub>DET3</sub>	+V <sub>DET3</sub>	V <sub>SW1</sub>
S-8424AAAFT-TB-x	8-Pin TSSOP	3.000	3.000	3.300	3.401	2.200	2.312	2.600	2.748	+V <sub>DET1</sub> × 0.85
S-8424AAAPA-TF-G	8-Pin SON(B)									
S-8424AABFT-TB-x	8-Pin TSSOP	3.300	3.300	4.000	4.129	2.300	2.420	2.500	2.640	+V <sub>DET1</sub> × 0.77
S-8424AACFT-TB-x	8-Pin TSSOP	3.200	3.200	3.300	3.401	2.400	2.528	2.600	2.748	+V <sub>DET1</sub> × 0.85
S-8424AADFT-TB-x	8-Pin TSSOP	5.000	5.000	4.600	4.753	2.300	2.420	2.500	2.640	+V <sub>DET1</sub> × 0.77
S-8424AAEFT-TB-x	8-Pin TSSOP	3.150	3.150	4.200	4.337	2.300	2.420	2.500	2.640	+V <sub>DET1</sub> × 0.77
S-8424AAFFT-TB-x	8-Pin TSSOP	3.200	3.200	4.400	4.545	2.400	2.528	2.600	2.748	+V <sub>DET1</sub> × 0.77
S-8424AAGFT-TB-x	8-Pin TSSOP	2.800	2.800	4.400	4.545	2.400	2.528	2.600	2.748	+V <sub>DET1</sub> × 0.77
S-8424AAHFT-TB-x	8-Pin TSSOP	5.000	5.000	4.600	4.753	2.550	2.690	2.700	2.856	+V <sub>DET1</sub> × 0.77
S-8424AAJFT-TB-x	8-Pin TSSOP	3.100	3.100	4.400	4.545	2.200	2.312	2.600	2.748	+V <sub>DET1</sub> × 0.77
S-8424AAKFT-TB-x	8-Pin TSSOP	3.200	3.200	4.600	4.753	2.400	2.528	2.600	2.748	+V <sub>DET1</sub> × 0.77

**Caution** Set the CS voltage so that the switch voltage (V<sub>SW1</sub>) is equal to or greater than the RESET detection voltage (-V<sub>DET2</sub>).

**Remark 1.** The selection range is as follows.

- V<sub>RO</sub>, V<sub>OUT</sub>: 2.3 to 5.4 V (0.1 V steps)
- V<sub>DET1</sub>: 2.4 to 5.3 V (0.1 V steps)
- V<sub>DET2</sub>: 1.7 to 3.4 V (0.1 V steps)
- V<sub>DET3</sub>: 1.7 to 3.4 V (0.1 V steps)
- V<sub>SW1</sub>: +V<sub>DET1</sub> × 0.85 or +V<sub>DET1</sub> × 0.77

2. If a product with a voltage other than above is required, contact our sales representative.

3. x: G or U

4. Please select products of environmental code = U for Sn 100%, halogen-free products.

■ Block Diagram

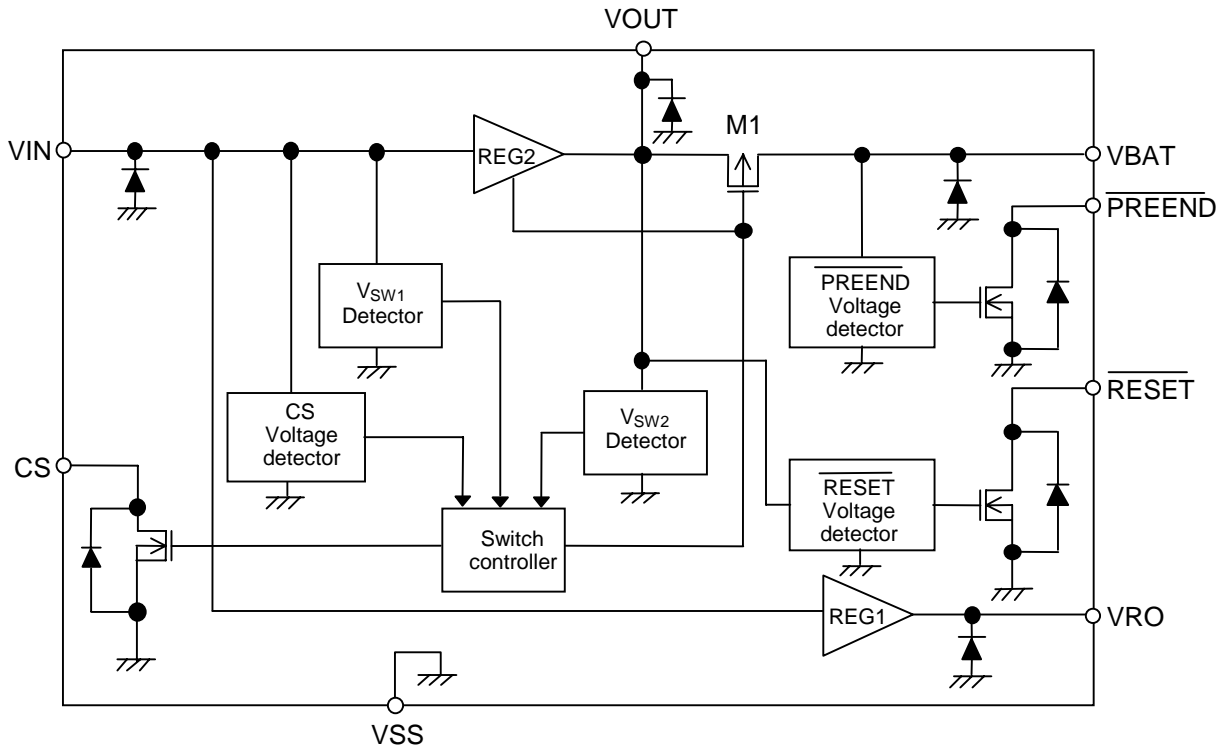
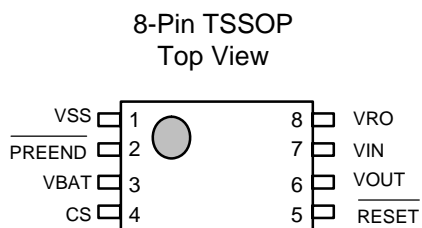

Figure 1 Block Diagram

■ **Pin Configurations**

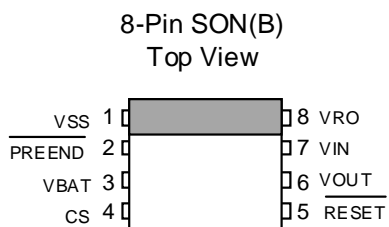

**Figure 2**

**Table 1**

Pin No.	Symbol	Description
1	VSS	Ground
2	$\overline{\text{PREEND}}$	Output pin of $\overline{\text{PREEND}}$ voltage detector
3	VBAT <sup>*1</sup>	Backup power supply input pin
4	CS	Output pin of CS voltage detector
5	$\overline{\text{RESET}}$	Output pin of $\overline{\text{RESET}}$ voltage detector
6	VOUT <sup>*2</sup>	Output pin of voltage regulator 2
7	VIN <sup>*3</sup>	Primary power supply input pin
8	VRO <sup>*4</sup>	Output pin of voltage regulator 1

**\*1 to \*4.** Mount capacitors between VSS (GND pin) and the VIN, VBAT, VOUT, and VRO pins. (Refer to the “**Standard Circuit**”)



**Figure 3**

**Table 2**

Pin No.	Symbol	Description
1	VSS	Ground
2	$\overline{\text{PREEND}}$	Output pin of $\overline{\text{PREEND}}$ voltage detector
3	VBAT <sup>*1</sup>	Backup power supply input pin
4	CS	Output pin of CS voltage detector
5	$\overline{\text{RESET}}$	Output pin of $\overline{\text{RESET}}$ voltage detector
6	VOUT <sup>*2</sup>	Output pin of voltage regulator 2
7	VIN <sup>*3</sup>	Primary power supply input pin
8	VRO <sup>*4</sup>	Output pin of voltage regulator 1

**\*1 to \*4.** Mount capacitors between VSS (GND pin) and the VIN, VBAT, VOUT, and VRO pins. (Refer to the “**Standard Circuit**”)

■ Absolute Maximum Ratings

Table 3 Absolute Maximum Ratings

(Unless otherwise specified: Ta = 25°C)

Parameter	Symbol	Ratings	Unit	
Primary power supply input voltage	$V_{IN}$	$V_{SS}-0.3$ to $V_{SS}+18$	V	
Backup power supply input voltage	$V_{BAT}$			
Output voltage of voltage regulator	$V_{RO}, V_{OUT}$	$V_{SS}-0.3$ to $V_{IN}+0.3$		
CS output voltage	$V_{CS}$			
RESET output voltage	$V_{RESET}$			
PREEND output voltage	$V_{PREEND}$			
Power dissipation	8-Pin TSSOP	$P_D$	mW	
	8-Pin SON(B)			
		300 (When not mounted on board)		
		$700^{*1}$		
		300 (When not mounted on board)		
		$750^{*1}$		
Operating ambient temperature	$T_{opr}$	-40 to +85	°C	
Storage temperature	$T_{stg}$	-40 to +125		

\*1. When mounted on board

[Mounted board]

- (1) Board size: 114.3 mm × 76.2 mm × t1.6 mm
- (2) Board name: JEDEC STANDARD51-7

**Caution** The absolute maximum ratings are rated values exceeding which the product could suffer physical damage. These values must therefore not be exceeded under any conditions.

(1) When mounted on board

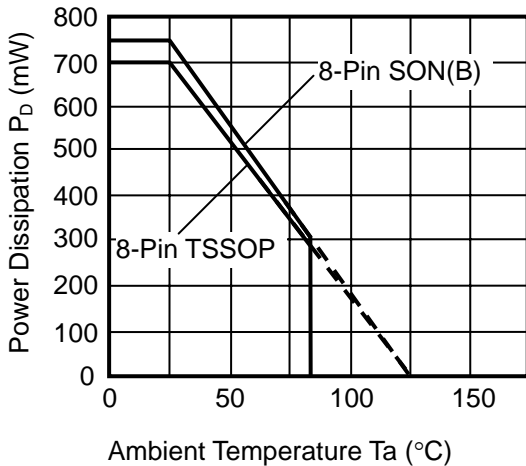

(2) When not mounted on board

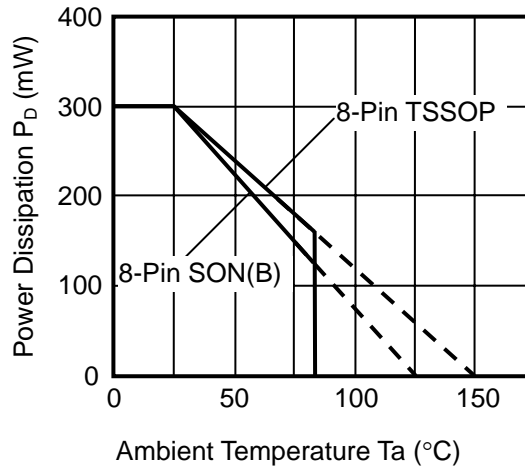

Figure 4 Power Dissipation of Package

■ Electrical Characteristics

1. S-8424AAxx

Table 4 Electrical Characteristics

(Unless otherwise specified: Ta = 25°C)

	Parameter	Symbol	Conditions	Min.	Typ.	Max.	Unit	Test Circuit	
Voltage regulator	Output voltage 1	$V_{RO}$	$V_{IN} = 7.2\text{ V}, I_{RO} = 3\text{ mA}$	2.940	3.000	3.060	V	1	
	Dropout voltage 1	$V_{drop1}$	$V_{IN} = 7.2\text{ V}, I_{RO} = 3\text{ mA}$	—	41	59	mV		
	Load stability 1	$\Delta V_{RO1}$	$V_{IN} = 7.2\text{ V}, I_{RO} = 0.1\text{ to }10\text{ mA}$	—	50	100	mV		
	Input stability 1	$\Delta V_{RO2}$	$V_{IN} = 4\text{ to }16\text{ V}, I_{RO} = 3\text{ mA}$	—	5	20	mV		
	Output voltage temperature coefficient 1	$\frac{\Delta V_{RO}}{\Delta T_a \bullet V_{RO}}$	Ta = -40°C to +85°C	—	±100	—	ppm/°C		
	Output voltage 2	$V_{OUT}$	$V_{IN} = 7.2\text{ V}, I_{OUT} = 23\text{ mA}$	2.940	3.000	3.060	V		
	Dropout voltage 2	$V_{drop2}$	$V_{IN} = 7.2\text{ V}, I_{OUT} = 23\text{ mA}$	—	187	252	mV		
	Load stability 2	$\Delta V_{OUT1}$	$V_{IN} = 7.2\text{ V}, I_{OUT} = 0.1\text{ to }60\text{ mA}$	—	50	100	mV		
	Input stability 2	$\Delta V_{OUT2}$	$V_{IN} = 4\text{ to }16\text{ V}, I_{OUT} = 23\text{ mA}$	—	5	20	mV		
	Output voltage temperature coefficient 2	$\frac{\Delta V_{OUT}}{\Delta T_a \bullet V_{OUT}}$	Ta = -40°C to +85°C	—	±100	—	ppm/°C		
	Primary power input voltage	$V_{IN}$	—	—	—	16	V		
Voltage detector	CS detection voltage	$-V_{DET1}$	$V_{IN}$ voltage detection	3.234	3.300	3.366	V	2	
	CS release voltage	$+V_{DET1}$	—	3.319	3.401	3.482	V		
	RESET detection voltage	$-V_{DET2}$	$V_{OUT}$ voltage detection	2.156	2.200	2.244	V		
	RESET release voltage	$+V_{DET2}$	—	2.256	2.312	2.367	V		
	PREEND detection voltage	$-V_{DET3}$	$V_{BAT}$ voltage detection	2.548	2.600	2.652	V		
	PREEND release voltage	$+V_{DET3}$	—	2.682	2.748	2.814	V		
	Operating voltage	$V_{opr}$	$V_{IN}$ or $V_{BAT}$	1.7	—	16	V		
	Detection voltage temperature coefficient	$\frac{\Delta - V_{DET1}}{\Delta T_a \bullet -V_{DET1}}$	Ta = -40°C to +85°C	—	±100	—	ppm/°C		
			Ta = -40°C to +85°C	—	±100	—	ppm/°C		
			Ta = -40°C to +85°C	—	±100	—	ppm/°C		
Sink current	$I_{SINK}$	$V_{DS} = 0.5\text{ V}, V_{IN} = V_{BAT} = 2.0\text{ V}$	RESET	1.50	2.30	—	mA	3	
			PREEND	1.50	2.30	—	mA		
			CS	1.50	2.30	—	mA		
Leakage current	$I_{LEAK}$	$V_{DS} = 16\text{ V}, V_{IN} = 16\text{ V}$	—	—	0.1	μA			
Switch unit	Switch voltage	$V_{SW1}$	$V_{BAT} = 2.8\text{ V}, V_{IN}$ voltage detection	$+V_{DET1} \times 0.83$	$+V_{DET1} \times 0.85$	$+V_{DET1} \times 0.87$	V	4	
	CS output inhibit voltage	$V_{SW2}$	$V_{BAT} = 3.0\text{ V}, V_{OUT}$ voltage detection	$V_{OUT} \times 0.93$	$V_{OUT} \times 0.95$	$V_{OUT} \times 0.97$	V	5	
	$V_{BAT}$ switch leakage current	$I_{LEAK}$	$V_{IN} = 3.6\text{ V}, V_{BAT} = 0\text{ V}$	—	—	0.1	μA	6	
	$V_{BAT}$ switch resistance	$R_{SW}$	$V_{IN} = \text{Open}, V_{BAT} = 3.0\text{ V}, I_{OUT} = 10\text{ to }500\text{ }\mu\text{A}$	—	30	60	Ω	7	
	Switch voltage temperature coefficient	$\frac{\Delta V_{SW1}}{\Delta T_a \bullet V_{SW1}}$	Ta = -40°C to +85°C	—	±100	—	ppm/°C	4	
	CS output inhibit voltage temperature coefficient	$\frac{\Delta V_{SW2}}{\Delta T_a \bullet V_{SW2}}$	Ta = -40°C to +85°C	—	±100	—	ppm/°C	5	
Total	Current consumption	$I_{SS1}$	$V_{IN} = 3.6\text{ V}, V_{BAT} = 3.0\text{ V}, \text{Unload}$	—	7	15	μA	8	
				—	0.26	0.50	μA		
		$I_{BAT1}$	$V_{IN} = \text{Open}, V_{BAT} = 3.0\text{ V}, \text{Unload}$	Ta = 25°C	—	1.0	2.1		μA
				Ta = 85°C	—	—	3.5		μA
Backup power supply input voltage	$V_{BAT}$	—	1.7	—	4.0	V	7		

Remark The number in the Test Circuit column corresponds to the circuit number in the "Test Circuit" section.

2. S-8424AABxx

Table 5 Electrical Characteristics

(Unless otherwise specified: Ta = 25°C)

	Parameter	Symbol	Conditions	Min.	Typ.	Max.	Unit	Test Circuit
Voltage regulator	Output voltage 1	$V_{RO}$	$V_{IN} = 6\text{ V}, I_{RO} = 30\text{ mA}$	3.234	3.300	3.366	V	1
	Dropout voltage 1	$V_{drop1}$	$V_{IN} = 6\text{ V}, I_{RO} = 30\text{ mA}$	—	356	474	mV	
	Load stability 1	$\Delta V_{RO1}$	$V_{IN} = 6\text{ V}, I_{RO} = 0.1\text{ to }40\text{ mA}$	—	50	100	mV	
	Input stability 1	$\Delta V_{RO2}$	$V_{IN} = 6\text{ to }16\text{ V}, I_{RO} = 30\text{ mA}$	—	5	20	mV	
	Output voltage temperature coefficient 1	$\frac{\Delta V_{RO}}{\Delta Ta \cdot V_{RO}}$	Ta = -40°C to +85°C	—	±100	—	ppm/°C	
	Output voltage 2	$V_{OUT}$	$V_{IN} = 6\text{ V}, I_{OUT} = 50\text{ mA}$	3.234	3.300	3.366	V	
	Dropout voltage 2	$V_{drop2}$	$V_{IN} = 6\text{ V}, I_{OUT} = 50\text{ mA}$	—	401	540	mV	
	Load stability 2	$\Delta V_{OUT1}$	$V_{IN} = 6\text{ V}, I_{OUT} = 0.1\text{ to }60\text{ mA}$	—	50	100	mV	
	Input stability 2	$\Delta V_{OUT2}$	$V_{IN} = 6\text{ to }16\text{ V}, I_{OUT} = 50\text{ mA}$	—	5	20	mV	
	Output voltage temperature coefficient 2	$\frac{\Delta V_{OUT}}{\Delta Ta \cdot V_{OUT}}$	Ta = -40°C to +85°C	—	±100	—	ppm/°C	
	Primary power input voltage	$V_{IN}$	—	—	—	16	V	
Voltage detector	CS detection voltage	$-V_{DET1}$	$V_{IN}$ voltage detection	3.920	4.000	4.080	V	2
	CS release voltage	$+V_{DET1}$	—	4.030	4.129	4.228	V	
	RESET detection voltage	$-V_{DET2}$	$V_{OUT}$ voltage detection	2.254	2.300	2.346	V	
	RESET release voltage	$+V_{DET2}$	—	2.362	2.420	2.478	V	
	PREEND detection voltage	$-V_{DET3}$	$V_{BAT}$ voltage detection	2.450	2.500	2.550	V	
	PREEND release voltage	$+V_{DET3}$	—	2.576	2.640	2.703	V	
	Operating voltage	$V_{OPR}$	$V_{IN}$ or $V_{BAT}$	1.7	—	16	V	
	Detection voltage temperature coefficient	$\frac{\Delta - V_{DET1}}{\Delta Ta \cdot -V_{DET1}}$	Ta = -40°C to +85°C	—	±100	—	ppm/°C	
		$\frac{\Delta - V_{DET2}}{\Delta Ta \cdot -V_{DET2}}$	Ta = -40°C to +85°C	—	±100	—	ppm/°C	
		$\frac{\Delta - V_{DET3}}{\Delta Ta \cdot -V_{DET3}}$	Ta = -40°C to +85°C	—	±100	—	ppm/°C	
Sink current	$I_{SINK}$	$V_{DS} = 0.5\text{ V}, V_{IN} = V_{BAT} = 2.0\text{ V}$	RESET	1.50	2.30	—	mA	3
			PREEND	1.50	2.30	—	mA	
			CS	1.50	2.30	—	mA	
Leakage current	$I_{LEAK}$	$V_{DS} = 16\text{ V}, V_{IN} = 16\text{ V}$	—	—	0.1	μA		
Switch unit	Switch voltage	$V_{SW1}$	$V_{BAT} = 2.8\text{ V}, V_{IN}$ voltage detection	$+V_{DET1} \times 0.75$	$+V_{DET1} \times 0.77$	$+V_{DET1} \times 0.79$	V	4
	CS output inhibit voltage	$V_{SW2}$	$V_{BAT} = 3.0\text{ V}$ $V_{OUT}$ voltage detection	$V_{OUT} \times 0.93$	$V_{OUT} \times 0.95$	$V_{OUT} \times 0.97$	V	5
	$V_{BAT}$ switch leakage current	$I_{LEAK}$	$V_{IN} = 6\text{ V}, V_{BAT} = 0\text{ V}$	—	—	0.1	μA	6
	$V_{BAT}$ switch resistance	$R_{SW}$	$V_{IN} = \text{Open}, V_{BAT} = 3.0\text{ V}, I_{OUT} = 10\text{ to }500\text{ }\mu\text{A}$	—	30	60	Ω	7
	Switch voltage temperature coefficient	$\frac{\Delta V_{SW1}}{\Delta Ta \cdot V_{SW1}}$	Ta = -40°C to +85°C	—	±100	—	ppm/°C	4
	CS output inhibit voltage temperature coefficient	$\frac{\Delta V_{SW2}}{\Delta Ta \cdot V_{SW2}}$	Ta = -40°C to +85°C	—	±100	—	ppm/°C	5
Total	Current consumption	$I_{SS1}$	$V_{IN} = 6\text{ V}, V_{BAT} = 3.0\text{ V}, \text{Unload}$	—	7	15	μA	8
		$I_{BAT1}$		—	0.26	0.50	μA	
	$I_{BAT2}$	$V_{IN} = \text{Open}, V_{BAT} = 3.0\text{ V}, \text{Unload}$	Ta = 25°C	—	1.0	2.1	μA	
		Ta = 85°C	—	—	3.5	μA		
Backup power supply input voltage	$V_{BAT}$	—	1.7	—	4.0	V	7	

Remark The number in the Test Circuit column corresponds to the circuit number in the "Test Circuit" section.



3. S-8424AACxx

Table 6 Electrical Characteristics

(Unless otherwise specified: Ta = 25°C)

	Parameter	Symbol	Conditions	Min.	Typ.	Max.	Unit	Test Circuit
Voltage regulator	Output voltage 1	$V_{RO}$	$V_{IN} = 3.6\text{ V}$ , $I_{RO} = 15\text{ mA}$	3.136	3.200	3.264	V	1
	Dropout voltage 1	$V_{drop1}$	$V_{IN} = 3.6\text{ V}$ , $I_{RO} = 15\text{ mA}$	—	181	243	mV	
	Load stability 1	$\Delta V_{RO1}$	$V_{IN} = 3.6\text{ V}$ , $I_{RO} = 0.1\text{ to }20\text{ mA}$	—	50	100	mV	
	Input stability 1	$\Delta V_{RO2}$	$V_{IN} = 3.6\text{ to }16\text{ V}$ , $I_{RO} = 15\text{ mA}$	—	5	20	mV	
	Output voltage temperature coefficient 1	$\frac{\Delta V_{RO}}{\Delta Ta \bullet V_{RO}}$	Ta = -40°C to +85°C	—	±100	—	ppm/°C	
	Output voltage 2	$V_{OUT}$	$V_{IN} = 3.6\text{ V}$ , $I_{OUT} = 15\text{ mA}$	3.136	3.200	3.264	V	
	Dropout voltage 2	$V_{drop2}$	$V_{IN} = 3.6\text{ V}$ , $I_{OUT} = 15\text{ mA}$	—	123	167	mV	
	Load stability 2	$\Delta V_{OUT1}$	$V_{IN} = 3.6\text{ V}$ , $I_{OUT} = 0.1\text{ to }20\text{ mA}$	—	50	100	mV	
	Input stability 2	$\Delta V_{OUT2}$	$V_{IN} = 3.6\text{ to }16\text{ V}$ , $I_{OUT} = 15\text{ mA}$	—	5	20	mV	
	Output voltage temperature coefficient 2	$\frac{\Delta V_{OUT}}{\Delta Ta \bullet V_{OUT}}$	Ta = -40°C to +85°C	—	±100	—	ppm/°C	
	Primary power input voltage	$V_{IN}$	—	—	—	16	V	
Voltage detector	CS detection voltage	$-V_{DET1}$	$V_{IN}$ voltage detection	3.234	3.300	3.366	V	2
	CS release voltage	$+V_{DET1}$	—	3.319	3.401	3.482	V	
	RESET detection voltage	$-V_{DET2}$	$V_{OUT}$ voltage detection	2.352	2.400	2.448	V	
	RESET release voltage	$+V_{DET2}$	—	2.467	2.528	2.589	V	
	PREEND detection voltage	$-V_{DET3}$	$V_{BAT}$ voltage detection	2.548	2.600	2.652	V	
	PREEND release voltage	$+V_{DET3}$	—	2.682	2.748	2.814	V	
	Operating voltage	$V_{OPF}$	$V_{IN}$ or $V_{BAT}$	1.7	—	16	V	
	Detection voltage temperature coefficient	$\frac{\Delta - V_{DET1}}{\Delta Ta \bullet -V_{DET1}}$	Ta = -40°C to +85°C	—	±100	—	ppm/°C	
		$\frac{\Delta - V_{DET2}}{\Delta Ta \bullet -V_{DET2}}$	Ta = -40°C to +85°C	—	±100	—	ppm/°C	
		$\frac{\Delta - V_{DET3}}{\Delta Ta \bullet -V_{DET3}}$	Ta = -40°C to +85°C	—	±100	—	ppm/°C	
Sink current	$I_{SINK}$	$V_{DS} = 0.5\text{ V}$ , $V_{IN} = V_{BAT} = 2.0\text{ V}$	RESET	1.50	2.30	—	mA	3
			PREEND	1.50	2.30	—	mA	
			CS	1.50	2.30	—	mA	
Leakage current	$I_{LEAK}$	$V_{DS} = 16\text{ V}$ , $V_{IN} = 16\text{ V}$	—	—	0.1	μA		
Switch unit	Switch voltage	$V_{SW1}$	$V_{BAT} = 2.8\text{ V}$ , $V_{IN}$ voltage detection	$+V_{DET1} \times 0.83$	$+V_{DET1} \times 0.85$	$+V_{DET1} \times 0.87$	V	4
	CS output inhibit voltage	$V_{SW2}$	$V_{BAT} = 3.0\text{ V}$ , $V_{OUT}$ voltage detection	$V_{OUT} \times 0.93$	$V_{OUT} \times 0.95$	$V_{OUT} \times 0.97$	V	5
	$V_{BAT}$ switch leakage current	$I_{LEAK}$	$V_{IN} = 3.6\text{ V}$ , $V_{BAT} = 0\text{ V}$	—	—	0.1	μA	6
	$V_{BAT}$ switch resistance	$R_{SW}$	$V_{IN} = \text{Open}$ , $V_{BAT} = 3.0\text{ V}$ , $I_{OUT} = 10\text{ to }500\text{ }\mu\text{A}$	—	30	60	Ω	7
	Switch voltage temperature coefficient	$\frac{\Delta V_{SW1}}{\Delta Ta \bullet V_{SW1}}$	Ta = -40°C to +85°C	—	±100	—	ppm/°C	4
	CS output inhibit voltage temperature coefficient	$\frac{\Delta V_{SW2}}{\Delta Ta \bullet V_{SW2}}$	Ta = -40°C to +85°C	—	±100	—	ppm/°C	5
Total	Current consumption	$I_{SS1}$	$V_{IN} = 3.6\text{ V}$ , $V_{BAT} = 3.0\text{ V}$ , Unload	—	7	15	μA	8
				$I_{BAT1}$	—	0.26	0.50	
		$I_{BAT2}$	$V_{IN} = \text{Open}$ , $V_{BAT} = 3.0\text{ V}$ , Unload	Ta = 25°C	—	1.0	2.1	
	Ta = 85°C			—	—	3.5	μA	
Backup power supply input voltage	$V_{BAT}$	—	1.7	—	4.0	V	7	

Remark The number in the Test Circuit column corresponds to the circuit number in the "Test Circuit" section.

4. S-8424AADxx

Table 7 Electrical Characteristics

(Unless otherwise specified: Ta = 25°C)

	Parameter	Symbol	Conditions	Min.	Typ.	Max.	Unit	Test Circuit
Voltage regulator	Output voltage 1	V <sub>RO</sub>	V <sub>IN</sub> = 6 V, I <sub>RO</sub> = 30 mA	4.900	5.000	5.100	V	1
	Dropout voltage 1	V <sub>drop1</sub>	V <sub>IN</sub> = 6 V, I <sub>RO</sub> = 30 mA	—	356	474	mV	
	Load stability 1	ΔV <sub>RO1</sub>	V <sub>IN</sub> = 6 V, I <sub>RO</sub> = 0.1 to 40 mA	—	50	100	mV	
	Input stability 1	ΔV <sub>RO2</sub>	V <sub>IN</sub> = 6 to 16 V, I <sub>RO</sub> = 30 mA	—	5	20	mV	
	Output voltage temperature coefficient 1	$\frac{\Delta V_{RO}}{\Delta T_a \bullet V_{RO}}$	Ta = -40°C to +85°C	—	±100	—	ppm/°C	
	Output voltage 2	V <sub>OUT</sub>	V <sub>IN</sub> = 6 V, I <sub>OUT</sub> = 50 mA	4.900	5.000	5.100	V	
	Dropout voltage 2	V <sub>drop2</sub>	V <sub>IN</sub> = 6 V, I <sub>OUT</sub> = 50 mA	—	401	540	mV	
	Load stability 2	ΔV <sub>OUT1</sub>	V <sub>IN</sub> = 6 V, I <sub>OUT</sub> = 0.1 to 60 mA	—	50	100	mV	
	Input stability 2	ΔV <sub>OUT2</sub>	V <sub>IN</sub> = 6 to 16 V, I <sub>OUT</sub> = 50 mA	—	5	20	mV	
	Output voltage temperature coefficient 2	$\frac{\Delta V_{OUT}}{\Delta T_a \bullet V_{OUT}}$	Ta = -40°C to +85°C	—	±100	—	ppm/°C	
	Primary power input voltage	V <sub>IN</sub>	—	—	—	16	V	
	Voltage detector	CS detection voltage	-V <sub>DET1</sub>	V <sub>IN</sub> voltage detection	4.508	4.600	4.692	
CS release voltage		+V <sub>DET1</sub>	—	4.639	4.753	4.867	V	
RESET detection voltage		-V <sub>DET2</sub>	V <sub>OUT</sub> voltage detection	2.254	2.300	2.346	V	
RESET release voltage		+V <sub>DET2</sub>	—	2.362	2.420	2.478	V	
PREEND detection voltage		-V <sub>DET3</sub>	V <sub>BAT</sub> voltage detection	2.450	2.500	2.550	V	
PREEND release voltage		+V <sub>DET3</sub>	—	2.576	2.640	2.703	V	
Operating voltage		V <sub>OPF</sub>	V <sub>IN</sub> or V <sub>BAT</sub>	1.7	—	16	V	
Detection voltage temperature coefficient		$\frac{\Delta - V_{DET1}}{\Delta T_a \bullet -V_{DET1}}$	Ta = -40°C to +85°C	—	±100	—	ppm/°C	
		$\frac{\Delta - V_{DET2}}{\Delta T_a \bullet -V_{DET2}}$	Ta = -40°C to +85°C	—	±100	—	ppm/°C	
		$\frac{\Delta - V_{DET3}}{\Delta T_a \bullet -V_{DET3}}$	Ta = -40°C to +85°C	—	±100	—	ppm/°C	
Sink current	I <sub>SINK</sub>	V <sub>DS</sub> = 0.5 V, V <sub>IN</sub> = V <sub>BAT</sub> = 2.0 V	RESET	1.50	2.30	—	mA	3
			PREEND	1.50	2.30	—	mA	
			CS	1.50	2.30	—	mA	
Leakage current	I <sub>LEAK</sub>	V <sub>DS</sub> = 16 V, V <sub>IN</sub> = 16 V	—	—	0.1	μA		
Switch unit	Switch voltage	V <sub>SW1</sub>	V <sub>BAT</sub> = 2.8 V, V <sub>IN</sub> voltage detection	+V <sub>DET1</sub> × 0.75	+V <sub>DET1</sub> × 0.77	+V <sub>DET1</sub> × 0.79	V	4
	CS output inhibit voltage	V <sub>SW2</sub>	V <sub>BAT</sub> = 3.0 V, V <sub>OUT</sub> voltage detection	V <sub>OUT</sub> × 0.93	V <sub>OUT</sub> × 0.95	V <sub>OUT</sub> × 0.97	V	5
	V <sub>BAT</sub> switch leakage current	I <sub>LEAK</sub>	V <sub>IN</sub> = 6 V, V <sub>BAT</sub> = 0 V	—	—	0.1	μA	6
	V <sub>BAT</sub> switch resistance	R <sub>SW</sub>	V <sub>IN</sub> = Open, V <sub>BAT</sub> = 3.0 V, I <sub>OUT</sub> = 10 to 500 μA	—	30	60	Ω	7
	Switch voltage temperature coefficient	$\frac{\Delta V_{SW1}}{\Delta T_a \bullet V_{SW1}}$	Ta = -40°C to +85°C	—	±100	—	ppm/°C	4
	CS output inhibit voltage temperature coefficient	$\frac{\Delta V_{SW2}}{\Delta T_a \bullet V_{SW2}}$	Ta = -40°C to +85°C	—	±100	—	ppm/°C	5
Total	Current consumption	I <sub>SS1</sub>	V <sub>IN</sub> = 6 V, V <sub>BAT</sub> = 3.0 V, Unload	—	7	15	μA	8
		I <sub>BAT1</sub>		—	0.26	0.50	μA	
	I <sub>BAT2</sub>	V <sub>IN</sub> = Open, V <sub>BAT</sub> = 3.0 V, Unload	Ta = 25°C	—	1.0	2.1	μA	
			Ta = 85°C	—	—	3.5	μA	
Backup power supply input voltage	V <sub>BAT</sub>	—	1.7	—	4.0	V	7	

Remark The number in the Test Circuit column corresponds to the circuit number in the "Test Circuit" section.

5. S-8424AAExx

Table 8 Electrical Characteristics

(Unless otherwise specified: Ta = 25°C)

	Parameter	Symbol	Conditions	Min.	Typ.	Max.	Unit	Test Circuit	
Voltage regulator	Output voltage 1	$V_{RO}$	$V_{IN} = 6\text{ V}, I_{RO} = 30\text{ mA}$	3.087	3.150	3.213	V	1	
	Dropout voltage 1	$V_{drop1}$	$V_{IN} = 6\text{ V}, I_{RO} = 30\text{ mA}$	—	356	474	mV		
	Load stability 1	$\Delta V_{RO1}$	$V_{IN} = 6\text{ V}, I_{RO} = 0.1\text{ to }30\text{ mA}$	—	50	100	mV		
	Input stability 1	$\Delta V_{RO2}$	$V_{IN} = 6\text{ to }16\text{ V}, I_{RO} = 30\text{ mA}$	—	5	20	mV		
	Output voltage temperature coefficient 1	$\frac{\Delta V_{RO}}{\Delta T_a \bullet V_{RO}}$	$T_a = -40^\circ\text{C to }+85^\circ\text{C}$	—	$\pm 100$	—	ppm/°C		
	Output voltage 2	$V_{OUT}$	$V_{IN} = 6\text{ V}, I_{OUT} = 50\text{ mA}$	3.087	3.150	3.213	V		
	Dropout voltage 2	$V_{drop2}$	$V_{IN} = 6\text{ V}, I_{OUT} = 50\text{ mA}$	—	401	540	mV		
	Load stability 2	$\Delta V_{OUT1}$	$V_{IN} = 6\text{ V}, I_{OUT} = 0.1\text{ to }60\text{ mA}$	—	50	100	mV		
	Input stability 2	$\Delta V_{OUT2}$	$V_{IN} = 6\text{ to }16\text{ V}, I_{OUT} = 50\text{ mA}$	—	5	20	mV		
	Output voltage temperature coefficient 2	$\frac{\Delta V_{OUT}}{\Delta T_a \bullet V_{OUT}}$	$T_a = -40^\circ\text{C to }+85^\circ\text{C}$	—	$\pm 100$	—	ppm/°C		
	Primary power input voltage	$V_{IN}$	—	—	—	16	V		
Voltage detector	CS detection voltage	$-V_{DET1}$	$V_{IN}$ voltage detection	4.116	4.200	4.284	V	2	
	CS release voltage	$+V_{DET1}$	—	4.233	4.337	4.441	V		
	RESET detection voltage	$-V_{DET2}$	$V_{OUT}$ voltage detection	2.254	2.300	2.346	V		
	RESET release voltage	$+V_{DET2}$	—	2.362	2.420	2.478	V		
	PREEND detection voltage	$-V_{DET3}$	$V_{BAT}$ voltage detection	2.450	2.500	2.550	V		
	PREEND release voltage	$+V_{DET3}$	—	2.576	2.640	2.703	V		
	Operating voltage	$V_{OPF}$	$V_{IN}$ or $V_{BAT}$	1.7	—	16	V		
	Detection voltage temperature coefficient	$\frac{\Delta - V_{DET1}}{\Delta T_a \bullet -V_{DET1}}$	$T_a = -40^\circ\text{C to }+85^\circ\text{C}$	—	$\pm 100$	—	ppm/°C		
			$T_a = -40^\circ\text{C to }+85^\circ\text{C}$	—	$\pm 100$	—	ppm/°C		
			$T_a = -40^\circ\text{C to }+85^\circ\text{C}$	—	$\pm 100$	—	ppm/°C		
Sink current	$I_{SINK}$	$V_{DS} = 0.5\text{ V}, V_{IN} = V_{BAT} = 2.0\text{ V}$	RESET	1.50	2.30	—	mA		
			PREEND	1.50	2.30	—	mA		
			CS	1.50	2.30	—	mA		
Leakage current	$I_{LEAK}$	$V_{DS} = 16\text{ V}, V_{IN} = 16\text{ V}$	—	—	0.1	μA			
Switch unit	Switch voltage	$V_{SW1}$	$V_{BAT} = 2.8\text{ V}, V_{IN}$ voltage detection	$+V_{DET1} \times 0.75$	$+V_{DET1} \times 0.77$	$+V_{DET1} \times 0.79$	V	4	
	CS output inhibit voltage	$V_{SW2}$	$V_{BAT} = 3.0\text{ V}, V_{OUT}$ voltage detection	$V_{OUT} \times 0.93$	$V_{OUT} \times 0.95$	$V_{OUT} \times 0.97$	V	5	
	$V_{BAT}$ switch leakage current	$I_{LEAK}$	$V_{IN} = 6\text{ V}, V_{BAT} = 0\text{ V}$	—	—	0.1	μA	6	
	$V_{BAT}$ switch resistance	$R_{SW}$	$V_{IN} = \text{Open}, V_{BAT} = 3.0\text{ V}, I_{OUT} = 10\text{ to }500\text{ }\mu\text{A}$	—	30	60	Ω	7	
	Switch voltage temperature coefficient	$\frac{\Delta V_{SW1}}{\Delta T_a \bullet V_{SW1}}$	$T_a = -40^\circ\text{C to }+85^\circ\text{C}$	—	$\pm 100$	—	ppm/°C	4	
	CS output inhibit voltage temperature coefficient	$\frac{\Delta V_{SW2}}{\Delta T_a \bullet V_{SW2}}$	$T_a = -40^\circ\text{C to }+85^\circ\text{C}$	—	$\pm 100$	—	ppm/°C	5	
Total	Current consumption	$I_{SS1}$	$V_{IN} = 6\text{ V}, V_{BAT} = 3.0\text{ V}, \text{Unload}$	—	7	15	μA	8	
				$I_{BAT1}$	—	0.26	0.50		μA
		$I_{BAT2}$	$V_{IN} = \text{Open}, V_{BAT} = 3.0\text{ V}, \text{Unload}$	$T_a = 25^\circ\text{C}$	—	1.0	2.1		μA
				$T_a = 85^\circ\text{C}$	—	—	3.5		μA
Backup power supply input voltage	$V_{BAT}$	—	1.7	—	4.0	V	7		

Remark The number in the Test Circuit column corresponds to the circuit number in the "Test Circuit" section.

6. S-8424AAFxx

Table 9 Electrical Characteristics

(Unless otherwise specified: Ta = 25°C)

	Parameter	Symbol	Conditions	Min.	Typ.	Max.	Unit	Test Circuit	
Voltage regulator	Output voltage 1	$V_{RO}$	$V_{IN} = 6\text{ V}, I_{RO} = 30\text{ mA}$	3.136	3.200	3.264	V	1	
	Dropout voltage 1	$V_{drop1}$	$V_{IN} = 6\text{ V}, I_{RO} = 30\text{ mA}$	—	356	474	mV		
	Load stability 1	$\Delta V_{RO1}$	$V_{IN} = 6\text{ V}, I_{RO} = 0.1\text{ to }30\text{ mA}$	—	50	100	mV		
	Input stability 1	$\Delta V_{RO2}$	$V_{IN} = 6\text{ to }16\text{ V}, I_{RO} = 30\text{ mA}$	—	5	20	mV		
	Output voltage temperature coefficient 1	$\frac{\Delta V_{RO}}{\Delta Ta \cdot V_{RO}}$	Ta = -40°C to +85°C	—	±100	—	ppm/°C		
	Output voltage 2	$V_{OUT}$	$V_{IN} = 6\text{ V}, I_{OUT} = 50\text{ mA}$	3.136	3.200	3.264	V		
	Dropout voltage 2	$V_{drop2}$	$V_{IN} = 6\text{ V}, I_{OUT} = 50\text{ mA}$	—	401	540	mV		
	Load stability 2	$\Delta V_{OUT1}$	$V_{IN} = 6\text{ V}, I_{OUT} = 0.1\text{ to }50\text{ mA}$	—	50	100	mV		
	Input stability 2	$\Delta V_{OUT2}$	$V_{IN} = 6\text{ to }16\text{ V}, I_{OUT} = 50\text{ mA}$	—	5	20	mV		
	Output voltage temperature coefficient 2	$\frac{\Delta V_{OUT}}{\Delta Ta \cdot V_{OUT}}$	Ta = -40°C to +85°C	—	±100	—	ppm/°C		
	Primary power input voltage	$V_{IN}$	—	—	—	16	V		
Voltage detector	CS detection voltage	$-V_{DET1}$	$V_{IN}$ voltage detection	4.312	4.400	4.488	V	2	
	CS release voltage	$+V_{DET1}$	—	4.436	4.545	4.654	V		
	RESET detection voltage	$-V_{DET2}$	$V_{OUT}$ voltage detection	2.352	2.400	2.448	V		
	RESET release voltage	$+V_{DET2}$	—	2.467	2.528	2.589	V		
	PREEND detection voltage	$-V_{DET3}$	$V_{BAT}$ voltage detection	2.548	2.600	2.652	V		
	PREEND release voltage	$+V_{DET3}$	—	2.682	2.748	2.814	V		
	Operating voltage	$V_{OPF}$	$V_{IN}$ or $V_{BAT}$	1.7	—	16	V		
	Detection voltage temperature coefficient	$\frac{\Delta - V_{DET1}}{\Delta Ta \cdot -V_{DET1}}$	Ta = -40°C to +85°C	—	±100	—	ppm/°C		
		$\frac{\Delta - V_{DET2}}{\Delta Ta \cdot -V_{DET2}}$	Ta = -40°C to +85°C	—	±100	—	ppm/°C		
		$\frac{\Delta - V_{DET3}}{\Delta Ta \cdot -V_{DET3}}$	Ta = -40°C to +85°C	—	±100	—	ppm/°C		
Sink current	$I_{SINK}$	$V_{DS} = 0.5\text{ V}, V_{IN} = V_{BAT} = 2.0\text{ V}$	RESET	1.50	2.30	—	mA	3	
			PREEND	1.50	2.30	—	mA		
			CS	1.50	2.30	—	mA		
Leakage current	$I_{LEAK}$	$V_{DS} = 16\text{ V}, V_{IN} = 16\text{ V}$	—	—	0.1	μA			
Switch unit	Switch voltage	$V_{SW1}$	$V_{BAT} = 2.8\text{ V}, V_{IN}$ voltage detection	$+V_{DET1} \times 0.75$	$+V_{DET1} \times 0.77$	$+V_{DET1} \times 0.79$	V	4	
	CS output inhibit voltage	$V_{SW2}$	$V_{BAT} = 3.0\text{ V}, V_{OUT}$ voltage detection	$V_{OUT} \times 0.93$	$V_{OUT} \times 0.95$	$V_{OUT} \times 0.97$	V	5	
	$V_{BAT}$ switch leakage current	$I_{LEAK}$	$V_{IN} = 6\text{ V}, V_{BAT} = 0\text{ V}$	—	—	0.1	μA	6	
	$V_{BAT}$ switch resistance	$R_{SW}$	$V_{IN} = \text{Open}, V_{BAT} = 3.0\text{ V}, I_{OUT} = 10\text{ to }500\text{ }\mu\text{A}$	—	30	60	Ω	7	
	Switch voltage temperature coefficient	$\frac{\Delta V_{SW1}}{\Delta Ta \cdot V_{SW1}}$	Ta = -40°C to +85°C	—	±100	—	ppm/°C	4	
	CS output inhibit voltage temperature coefficient	$\frac{\Delta V_{SW2}}{\Delta Ta \cdot V_{SW2}}$	Ta = -40°C to +85°C	—	±100	—	ppm/°C	5	
Total	Current consumption	$I_{SS1}$	$V_{IN} = 6\text{ V}, V_{BAT} = 3.0\text{ V}, \text{Unload}$	—	7	15	μA	8	
		$I_{BAT1}$		—	0.26	0.50	μA		
		$I_{BAT2}$	$V_{IN} = \text{Open}, V_{BAT} = 3.0\text{ V}, \text{Unload}$	Ta = 25°C	—	1.0	2.1		μA
				Ta = 85°C	—	—	3.5		μA
Backup power supply input voltage	$V_{BAT}$	—	1.7	—	4.0	V	7		

Remark The number in the Test Circuit column corresponds to the circuit number in the "Test Circuit" section.

**7. S-8424AAGxx**

**Table 10 Electrical Characteristics**

(Unless otherwise specified: Ta = 25°C)

	Parameter	Symbol	Conditions	Min.	Typ.	Max.	Unit	Test Circuit	
Voltage regulator	Output voltage 1	V <sub>RO</sub>	V <sub>IN</sub> = 6 V, I <sub>RO</sub> = 30 mA	2.744	2.800	2.856	V	1	
	Dropout voltage 1	V <sub>drop1</sub>	V <sub>IN</sub> = 6 V, I <sub>RO</sub> = 30 mA	—	356	474	mV		
	Load stability 1	ΔV <sub>RO1</sub>	V <sub>IN</sub> = 6 V, I <sub>RO</sub> = 0.1 to 30 mA	—	50	100	mV		
	Input stability 1	ΔV <sub>RO2</sub>	V <sub>IN</sub> = 6 to 16 V, I <sub>RO</sub> = 30 mA	—	5	20	mV		
	Output voltage temperature coefficient 1	$\frac{\Delta V_{RO}}{\Delta T_a \bullet V_{RO}}$	Ta = -40°C to +85°C	—	±100	—	ppm/°C		
	Output voltage 2	V <sub>OUT</sub>	V <sub>IN</sub> = 6 V, I <sub>OUT</sub> = 50 mA	2.744	2.800	2.856	V		
	Dropout voltage 2	V <sub>drop2</sub>	V <sub>IN</sub> = 6 V, I <sub>OUT</sub> = 50 mA	—	401	540	mV		
	Load stability 2	ΔV <sub>OUT1</sub>	V <sub>IN</sub> = 6 V, I <sub>OUT</sub> = 0.1 to 50 mA	—	50	100	mV		
	Input stability 2	ΔV <sub>OUT2</sub>	V <sub>IN</sub> = 6 to 16 V, I <sub>OUT</sub> = 50 mA	—	5	20	mV		
	Output voltage temperature coefficient 2	$\frac{\Delta V_{OUT}}{\Delta T_a \bullet V_{OUT}}$	Ta = -40°C to +85°C	—	±100	—	ppm/°C		
	Primary power input voltage	V <sub>IN</sub>	—	—	—	16	V		
Voltage detector	CS detection voltage	-V <sub>DET1</sub>	V <sub>IN</sub> voltage detection	4.312	4.400	4.488	V	2	
	CS release voltage	+V <sub>DET1</sub>		4.436	4.545	4.654	V		
	detection voltage	-V <sub>DET2</sub>	V <sub>OUT</sub> voltage detection	2.352	2.400	2.448	V		
	RESET release voltage	+V <sub>DET2</sub>		2.467	2.528	2.589	V		
	PREEND detection voltage	-V <sub>DET3</sub>	V <sub>BAT</sub> voltage detection	2.548	2.600	2.652	V		
	PREEND release voltage	+V <sub>DET3</sub>		2.682	2.748	2.814	V		
	Operating voltage	V <sub>odr</sub>	V <sub>IN</sub> or V <sub>BAT</sub>	1.7	—	16	V		
	Detection voltage temperature coefficient	$\frac{\Delta - V_{DET1}}{\Delta T_a \bullet -V_{DET1}}$	Ta = -40°C to +85°C	—	±100	—	ppm/°C		
			Ta = -40°C to +85°C	—	±100	—	ppm/°C		
			Ta = -40°C to +85°C	—	±100	—	ppm/°C		
Sink current	I <sub>SINK</sub>	V <sub>DS</sub> = 0.5 V, V <sub>IN</sub> = V <sub>BAT</sub> = 2.0 V	RESET	1.50	2.30	—	mA		
			PREEND	1.50	2.30	—	mA		
			CS	1.50	2.30	—	mA		
Leakage current	I <sub>LEAK</sub>	V <sub>DS</sub> = 16 V, V <sub>IN</sub> = 16 V	—	—	0.1	μA			
Switch unit	Switch voltage	V <sub>SW1</sub>	V <sub>BAT</sub> = 2.8 V, V <sub>IN</sub> voltage detection	+V <sub>DET1</sub> × 0.75	+V <sub>DET1</sub> × 0.77	+V <sub>DET1</sub> × 0.79	V	4	
	CS output inhibit voltage	V <sub>SW2</sub>	V <sub>BAT</sub> = 3.0 V, V <sub>OUT</sub> voltage detection	V <sub>OUT</sub> × 0.93	V <sub>OUT</sub> × 0.95	V <sub>OUT</sub> × 0.97	V	5	
	V <sub>BAT</sub> switch leakage current	I <sub>LEAK</sub>	V <sub>IN</sub> = 6 V, V <sub>BAT</sub> = 0 V	—	—	0.1	μA	6	
	V <sub>BAT</sub> switch resistance	R <sub>SW</sub>	V <sub>IN</sub> = Open, V <sub>BAT</sub> = 3.0 V, I <sub>OUT</sub> = 10 to 500 μA	—	30	60	Ω	7	
	Switch voltage temperature coefficient	$\frac{\Delta V_{SW1}}{\Delta T_a \bullet V_{SW1}}$	Ta = -40°C to +85°C	—	±100	—	ppm/°C	4	
	CS output inhibit voltage temperature coefficient	$\frac{\Delta V_{SW2}}{\Delta T_a \bullet V_{SW2}}$	Ta = -40°C to +85°C	—	±100	—	ppm/°C	5	
Total	Current consumption	I <sub>SS1</sub>	V <sub>IN</sub> = 6 V, V <sub>BAT</sub> = 3.0 V, Unload	—	7	15	μA	8	
				I <sub>BAT1</sub>	—	0.26	0.50		μA
		I <sub>BAT2</sub>	V <sub>IN</sub> = Open, V <sub>BAT</sub> = 3.0 V, Unload	Ta = 25°C	—	1.0	2.1		μA
				Ta = 85°C	—	—	3.5		μA
Backup power supply input voltage	V <sub>BAT</sub>	—	1.7	—	4.0	V	7		

**Remark** The number in the Test Circuit column corresponds to the circuit number in the "Test Circuit" section.

8. S-8424AAHxx

Table 11 Electrical Characteristics

(Unless otherwise specified: Ta = 25°C)

	Parameter	Symbol	Conditions	Min.	Typ.	Max.	Unit	Test Circuit
Voltage regulator	Output voltage 1	$V_{RO}$	$V_{IN} = 6\text{ V}, I_{RO} = 30\text{ mA}$	4.900	5.000	5.100	V	1
	Dropout voltage 1	$V_{drop1}$	$V_{IN} = 6\text{ V}, I_{RO} = 30\text{ mA}$	—	356	474	mV	
	Load stability 1	$\Delta V_{RO1}$	$V_{IN} = 6\text{ V}, I_{RO} = 0.1\text{ to }40\text{ mA}$	—	50	100	mV	
	Input stability 1	$\Delta V_{RO2}$	$V_{IN} = 6\text{ to }16\text{ V}, I_{RO} = 30\text{ mA}$	—	5	20	mV	
	Output voltage temperature coefficient 1	$\frac{\Delta V_{RO}}{\Delta Ta \bullet V_{RO}}$	Ta = -40°C to +85°C	—	±100	—	ppm/°C	
	Output voltage 2	$V_{OUT}$	$V_{IN} = 6\text{ V}, I_{OUT} = 50\text{ mA}$	4.900	5.000	5.100	V	
	Dropout voltage 2	$V_{drop2}$	$V_{IN} = 6\text{ V}, I_{OUT} = 50\text{ mA}$	—	401	540	mV	
	Load stability 2	$\Delta V_{OUT1}$	$V_{IN} = 6\text{ V}, I_{OUT} = 0.1\text{ to }60\text{ mA}$	—	50	100	mV	
	Input stability 2	$\Delta V_{OUT2}$	$V_{IN} = 6\text{ to }16\text{ V}, I_{OUT} = 50\text{ mA}$	—	5	20	mV	
	Output voltage temperature coefficient 2	$\frac{\Delta V_{OUT}}{\Delta Ta \bullet V_{OUT}}$	Ta = -40°C to +85°C	—	±100	—	ppm/°C	
	Primary power input voltage	$V_{IN}$	—	—	—	16	V	
Voltage detector	CS detection voltage	$-V_{DET1}$	$V_{IN}$ voltage detection	4.508	4.600	4.692	V	2
	CS release voltage	$+V_{DET1}$		4.639	4.753	4.867	V	
	RESET detection voltage	$-V_{DET2}$	$V_{OUT}$ voltage detection	2.499	2.550	2.601	V	
	RESET release voltage	$+V_{DET2}$		2.625	2.690	2.754	V	
	PREEND detection voltage	$-V_{DET3}$	$V_{BAT}$ voltage detection	2.646	2.700	2.754	V	
	PREEND release voltage	$+V_{DET3}$		2.787	2.856	2.924	V	
	Operating voltage	$V_{OPF}$	$V_{IN}$ or $V_{BAT}$	1.7	—	16	V	
	Detection voltage temperature coefficient	$\frac{\Delta - V_{DET1}}{\Delta Ta \bullet -V_{DET1}}$	Ta = -40°C to +85°C	—	±100	—	ppm/°C	
		$\frac{\Delta - V_{DET2}}{\Delta Ta \bullet -V_{DET2}}$	Ta = -40°C to +85°C	—	±100	—	ppm/°C	
		$\frac{\Delta - V_{DET3}}{\Delta Ta \bullet -V_{DET3}}$	Ta = -40°C to +85°C	—	±100	—	ppm/°C	
Sink current	$I_{SINK}$	$V_{DS} = 0.5\text{ V}, V_{IN} = V_{BAT} = 2.0\text{ V}$	RESET	1.50	2.30	—	mA	3
			PREEND	1.50	2.30	—	mA	
			CS	1.50	2.30	—	mA	
Leakage current	$I_{LEAK}$	$V_{DS} = 16\text{ V}, V_{IN} = 16\text{ V}$	—	—	0.1	μA		
Switch unit	Switch voltage	$V_{SW1}$	$V_{BAT} = 2.8\text{ V}, V_{IN}$ voltage detection	$+V_{DET1} \times 0.75$	$+V_{DET1} \times 0.77$	$+V_{DET1} \times 0.79$	V	4
	CS output inhibit voltage	$V_{SW2}$	$V_{BAT} = 3.0\text{ V}, V_{OUT}$ voltage detection	$V_{OUT} \times 0.93$	$V_{OUT} \times 0.95$	$V_{OUT} \times 0.97$	V	5
	$V_{BAT}$ switch leakage current	$I_{LEAK}$	$V_{IN} = 6\text{ V}, V_{BAT} = 0\text{ V}$	—	—	0.1	μA	6
	$V_{BAT}$ switch resistance	$R_{SW}$	$V_{IN} = \text{Open}, V_{BAT} = 3.0\text{ V}, I_{OUT} = 10\text{ to }500\text{ μA}$	—	30	60	Ω	7
	Switch voltage temperature coefficient	$\frac{\Delta V_{SW1}}{\Delta Ta \bullet V_{SW1}}$	Ta = -40°C to +85°C	—	±100	—	ppm/°C	4
	CS output inhibit voltage temperature coefficient	$\frac{\Delta V_{SW2}}{\Delta Ta \bullet V_{SW2}}$	Ta = -40°C to +85°C	—	±100	—	ppm/°C	5
Total	Current consumption	$I_{SS1}$	$V_{IN} = 6\text{ V}, V_{BAT} = 3.0\text{ V}, \text{Unload}$	—	7	15	μA	8
		$I_{BAT1}$		—	0.26	0.50	μA	
	$I_{BAT2}$	$V_{IN} = \text{Open}, V_{BAT} = 3.0\text{ V}, \text{Unload}$	Ta = 25°C	—	1.0	2.1	μA	
			Ta = 85°C	—	—	3.5	μA	
Backup power supply input voltage	$V_{BAT}$	—	1.7	—	4.0	V	7	

Remark The number in the Test Circuit column corresponds to the circuit number in the "Test Circuit" section.

9. S-8424AAJFxx

Table 12 Electrical Characteristics

(Unless otherwise specified: Ta = 25°C)

	Parameter	Symbol	Conditions	Min.	Typ.	Max.	Unit	Test Circuit
Voltage regulator	Output voltage 1	$V_{RO}$	$V_{IN} = 6\text{ V}, I_{RO} = 10\text{ mA}$	3.038	3.100	3.162	V	1
	Dropout voltage 1	$V_{drop1}$	$V_{IN} = 6\text{ V}, I_{RO} = 10\text{ mA}$	—	123	167	mV	
	Load stability 1	$\Delta V_{RO1}$	$V_{IN} = 6\text{ V}, I_{RO} = 0.1\text{ to }15\text{ mA}$	—	50	100	mV	
	Input stability 1	$\Delta V_{RO2}$	$V_{IN} = 6\text{ to }16\text{ V}, I_{RO} = 10\text{ mA}$	—	5	20	mV	
	Output voltage temperature coefficient 1	$\frac{\Delta V_{RO}}{\Delta T_a \bullet V_{RO}}$	Ta = -40°C to +85°C	—	±100	—	ppm/°C	
	Output voltage 2	$V_{OUT}$	$V_{IN} = 6\text{ V}, I_{OUT} = 50\text{ mA}$	3.038	3.100	3.162	V	
	Dropout voltage 2	$V_{drop2}$	$V_{IN} = 6\text{ V}, I_{OUT} = 50\text{ mA}$	—	401	540	mV	
	Load stability 2	$\Delta V_{OUT1}$	$V_{IN} = 6\text{ V}, I_{OUT} = 0.1\text{ to }60\text{ mA}$	—	50	100	mV	
	Input stability 2	$\Delta V_{OUT2}$	$V_{IN} = 6\text{ to }16\text{ V}, I_{OUT} = 50\text{ mA}$	—	5	20	mV	
	Output voltage temperature coefficient 2	$\frac{\Delta V_{OUT}}{\Delta T_a \bullet V_{OUT}}$	Ta = -40°C to +85°C	—	±100	—	ppm/°C	
	Primary power input voltage	$V_{IN}$	—	—	—	16	V	
Voltage detector	CS detection voltage	$-V_{DET1}$	$V_{IN}$ voltage detection	4.312	4.400	4.488	V	2
	CS release voltage	$+V_{DET1}$	—	4.436	4.545	4.654	V	
	RESET detection voltage	$-V_{DET2}$	$V_{OUT}$ voltage detection	2.156	2.200	2.244	V	
	RESET release voltage	$+V_{DET2}$	—	2.256	2.312	2.367	V	
	PREEND detection voltage	$-V_{DET3}$	$V_{BAT}$ voltage detection	2.548	2.600	2.652	V	
	PREEND release voltage	$+V_{DET3}$	—	2.682	2.748	2.814	V	
	Operating voltage	$V_{OPF}$	$V_{IN}$ or $V_{BAT}$	1.7	—	16	V	
	Detection voltage temperature coefficient	$\frac{\Delta - V_{DET1}}{\Delta T_a \bullet -V_{DET1}}$	Ta = -40°C to +85°C	—	±100	—	ppm/°C	
		$\frac{\Delta - V_{DET2}}{\Delta T_a \bullet -V_{DET2}}$	Ta = -40°C to +85°C	—	±100	—	ppm/°C	
		$\frac{\Delta - V_{DET3}}{\Delta T_a \bullet -V_{DET3}}$	Ta = -40°C to +85°C	—	±100	—	ppm/°C	
Sink current	$I_{SINK}$	$V_{DS} = 0.5\text{ V}, V_{IN} = V_{BAT} = 2.0\text{ V}$	RESET	1.50	2.30	—	mA	3
			PREEND	1.50	2.30	—	mA	
			CS	1.50	2.30	—	mA	
Leakage current	$I_{LEAK}$	$V_{DS} = 16\text{ V}, V_{IN} = 16\text{ V}$	—	—	0.1	μA		
Switch unit	Switch voltage	$V_{SW1}$	$V_{BAT} = 2.8\text{ V}, V_{IN}$ voltage detection	$+V_{DET1} \times 0.75$	$+V_{DET1} \times 0.77$	$+V_{DET1} \times 0.79$	V	4
	CS output inhibit voltage	$V_{SW2}$	$V_{BAT} = 3.0\text{ V}, V_{OUT}$ voltage detection	$V_{OUT} \times 0.93$	$V_{OUT} \times 0.95$	$V_{OUT} \times 0.97$	V	5
	$V_{BAT}$ switch leakage current	$I_{LEAK}$	$V_{IN} = 6\text{ V}, V_{BAT} = 0\text{ V}$	—	—	0.1	μA	6
	$V_{BAT}$ switch resistance	$R_{SW}$	$V_{IN} = \text{Open}, V_{BAT} = 3.0\text{ V}, I_{OUT} = 10\text{ to }500\text{ }\mu\text{A}$	—	30	60	Ω	7
	Switch voltage temperature coefficient	$\frac{\Delta V_{SW1}}{\Delta T_a \bullet V_{SW1}}$	Ta = -40°C to +85°C	—	±100	—	ppm/°C	4
	CS output inhibit voltage temperature coefficient	$\frac{\Delta V_{SW2}}{\Delta T_a \bullet V_{SW2}}$	Ta = -40°C to +85°C	—	±100	—	ppm/°C	5
Total	Current consumption	$I_{SS1}$	$V_{IN} = 6\text{ V}, V_{BAT} = 3.0\text{ V}, \text{Unload}$	—	7	15	μA	8
				$I_{BAT1}$	—	0.26	0.50	
		$I_{BAT2}$	$V_{IN} = \text{Open}, V_{BAT} = 3.0\text{ V}, \text{Unload}$	Ta = 25°C	—	1.0	2.1	
	Ta = 85°C			—	—	3.5	μA	
Backup power supply input voltage	$V_{BAT}$	—	1.7	—	4.0	V	7	

Remark The number in the Test Circuit column corresponds to the circuit number in the "Test Circuit" section.

10. S-8424AAKxx

Table 13 Electrical Characteristics

(Unless otherwise specified: Ta = 25°C)

	Parameter	Symbol	Conditions	Min.	Typ.	Max.	Unit	Test Circuit
Voltage regulator	Output voltage 1	$V_{RO}$	$V_{IN} = 6\text{ V}$ , $I_{RO} = 10\text{ mA}$	3.136	3.200	3.264	V	1
	Dropout voltage 1	$V_{drop1}$	$V_{IN} = 6\text{ V}$ , $I_{RO} = 10\text{ mA}$	—	123	167	mV	
	Load stability 1	$\Delta V_{RO1}$	$V_{IN} = 6\text{ V}$ , $I_{RO} = 0.1\text{ to }15\text{ mA}$	—	50	100	mV	
	Input stability 1	$\Delta V_{RO2}$	$V_{IN} = 6\text{ to }16\text{ V}$ , $I_{RO} = 10\text{ mA}$	—	5	20	mV	
	Output voltage temperature coefficient 1	$\frac{\Delta V_{RO}}{\Delta T_a \bullet V_{RO}}$	Ta = -40°C to +85°C	—	±100	—	ppm/°C	
	Output voltage 2	$V_{OUT}$	$V_{IN} = 6\text{ V}$ , $I_{OUT} = 50\text{ mA}$	3.136	3.200	3.264	V	
	Dropout voltage 2	$V_{drop2}$	$V_{IN} = 6\text{ V}$ , $I_{OUT} = 50\text{ mA}$	—	401	540	mV	
	Load stability 2	$\Delta V_{OUT1}$	$V_{IN} = 6\text{ V}$ , $I_{OUT} = 0.1\text{ to }60\text{ mA}$	—	50	100	mV	
	Input stability 2	$\Delta V_{OUT2}$	$V_{IN} = 6\text{ to }16\text{ V}$ , $I_{OUT} = 50\text{ mA}$	—	5	20	mV	
	Output voltage temperature coefficient 2	$\frac{\Delta V_{OUT}}{\Delta T_a \bullet V_{OUT}}$	Ta = -40°C to +85°C	—	±100	—	ppm/°C	
	Primary power input voltage	$V_{IN}$	—	—	—	16	V	
Voltage detector	CS detection voltage	$-V_{DET1}$	$V_{IN}$ voltage detection	4.508	4.600	4.692	V	2
	CS release voltage	$+V_{DET1}$	—	4.639	4.753	4.867	V	
	RESET detection voltage	$-V_{DET2}$	$V_{OUT}$ voltage detection	2.352	2.400	2.448	V	
	RESET release voltage	$+V_{DET2}$	—	2.467	2.528	2.589	V	
	PREEND detection voltage	$-V_{DET3}$	$V_{BAT}$ voltage detection	2.548	2.600	2.652	V	
	PREEND release voltage	$+V_{DET3}$	—	2.682	2.748	2.814	V	
	Operating voltage	$V_{OPF}$	$V_{IN}$ or $V_{BAT}$	1.7	—	16	V	
	Detection voltage temperature coefficient	$\frac{\Delta - V_{DET1}}{\Delta T_a \bullet -V_{DET1}}$	Ta = -40°C to +85°C	—	±100	—	ppm/°C	
		$\frac{\Delta - V_{DET2}}{\Delta T_a \bullet -V_{DET2}}$	Ta = -40°C to +85°C	—	±100	—	ppm/°C	
		$\frac{\Delta - V_{DET3}}{\Delta T_a \bullet -V_{DET3}}$	Ta = -40°C to +85°C	—	±100	—	ppm/°C	
Sink current	$I_{SINK}$	$V_{DS} = 0.5\text{ V}$ , $V_{IN} = V_{BAT} = 2.0\text{ V}$	RESET	1.50	2.30	—	mA	3
			PREEND	1.50	2.30	—	mA	
			CS	1.50	2.30	—	mA	
Leakage current	$I_{LEAK}$	$V_{DS} = 16\text{ V}$ , $V_{IN} = 16\text{ V}$	—	—	0.1	μA		
Switch unit	Switch voltage	$V_{SW1}$	$V_{BAT} = 2.8\text{ V}$ , $V_{IN}$ voltage detection	$+V_{DET1} \times 0.75$	$+V_{DET1} \times 0.77$	$+V_{DET1} \times 0.79$	V	4
	CS output inhibit voltage	$V_{SW2}$	$V_{BAT} = 3.0\text{ V}$ , $V_{OUT}$ voltage detection	$V_{OUT} \times 0.93$	$V_{OUT} \times 0.95$	$V_{OUT} \times 0.97$	V	5
	$V_{BAT}$ switch leakage current	$I_{LEAK}$	$V_{IN} = 6\text{ V}$ , $V_{BAT} = 0\text{ V}$	—	—	0.1	μA	6
	$V_{BAT}$ switch resistance	$R_{SW}$	$V_{IN} = \text{Open}$ , $V_{BAT} = 3.0\text{ V}$ , $I_{OUT} = 10\text{ to }500\text{ }\mu\text{A}$	—	30	60	Ω	7
	Switch voltage temperature coefficient	$\frac{\Delta V_{SW1}}{\Delta T_a \bullet V_{SW1}}$	Ta = -40°C to +85°C	—	±100	—	ppm/°C	4
	CS output inhibit voltage temperature coefficient	$\frac{\Delta V_{SW2}}{\Delta T_a \bullet V_{SW2}}$	Ta = -40°C to +85°C	—	±100	—	ppm/°C	5
Total	Current consumption	$I_{SS1}$	$V_{IN} = 6\text{ V}$ , $V_{BAT} = 3.0\text{ V}$ , Unload	—	7	15	μA	8
		$I_{BAT1}$		—	0.26	0.50	μA	
	$I_{BAT2}$	$V_{IN} = \text{Open}$ , $V_{BAT} = 3.0\text{ V}$ , Unload	Ta = 25°C	—	1.0	2.1	μA	
			Ta = 85°C	—	—	3.5	μA	
Backup power supply input voltage	$V_{BAT}$	—	1.7	—	4.0	V	7	

Remark The number in the Test Circuit column corresponds to the circuit number in the "Test Circuit" section.



■ Test Circuit

1.

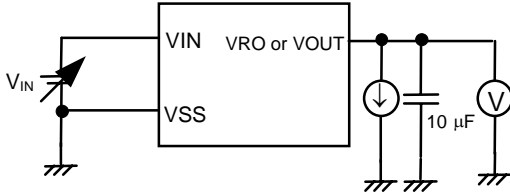

2.

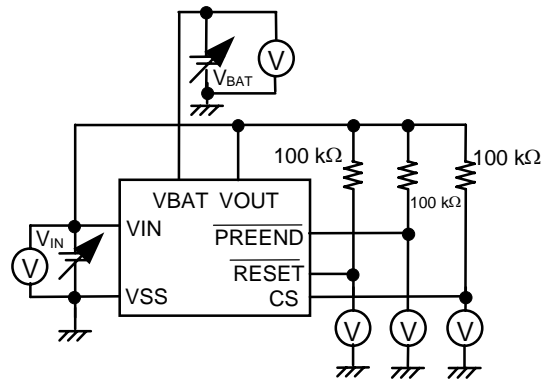

To measure  $V_{DET3}$ , apply 6 V to  $V_{IN}$ .

3.

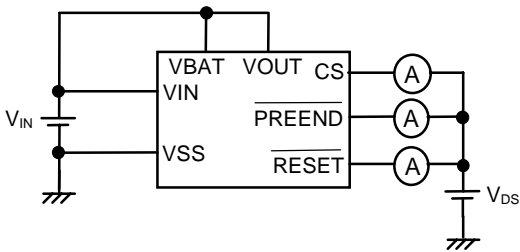

4.

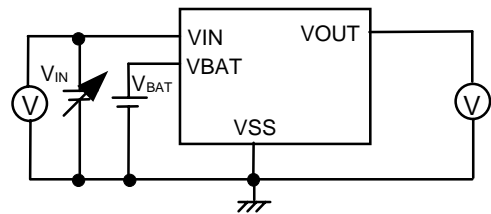

Measure the value after applying 6 V to  $V_{IN}$ .

5.

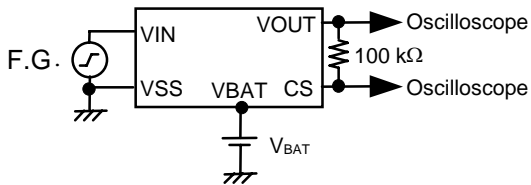

6.

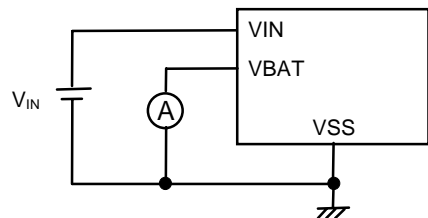

7.

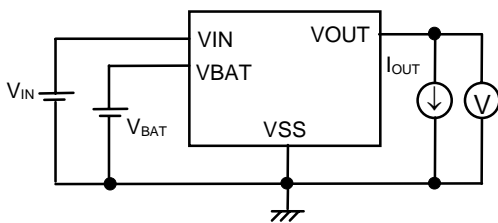

Leave open and measure the value after applying 6 V to  $V_{IN}$ .

8.

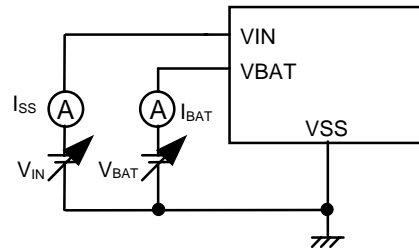

To measure  $I_{BAT2}$ , apply 6 V to  $V_{IN}$  and then leave  $V_{IN}$  open and measure  $I_{BAT}$ .

Figure 5 Test Circuit

■ Operation Timing Chart

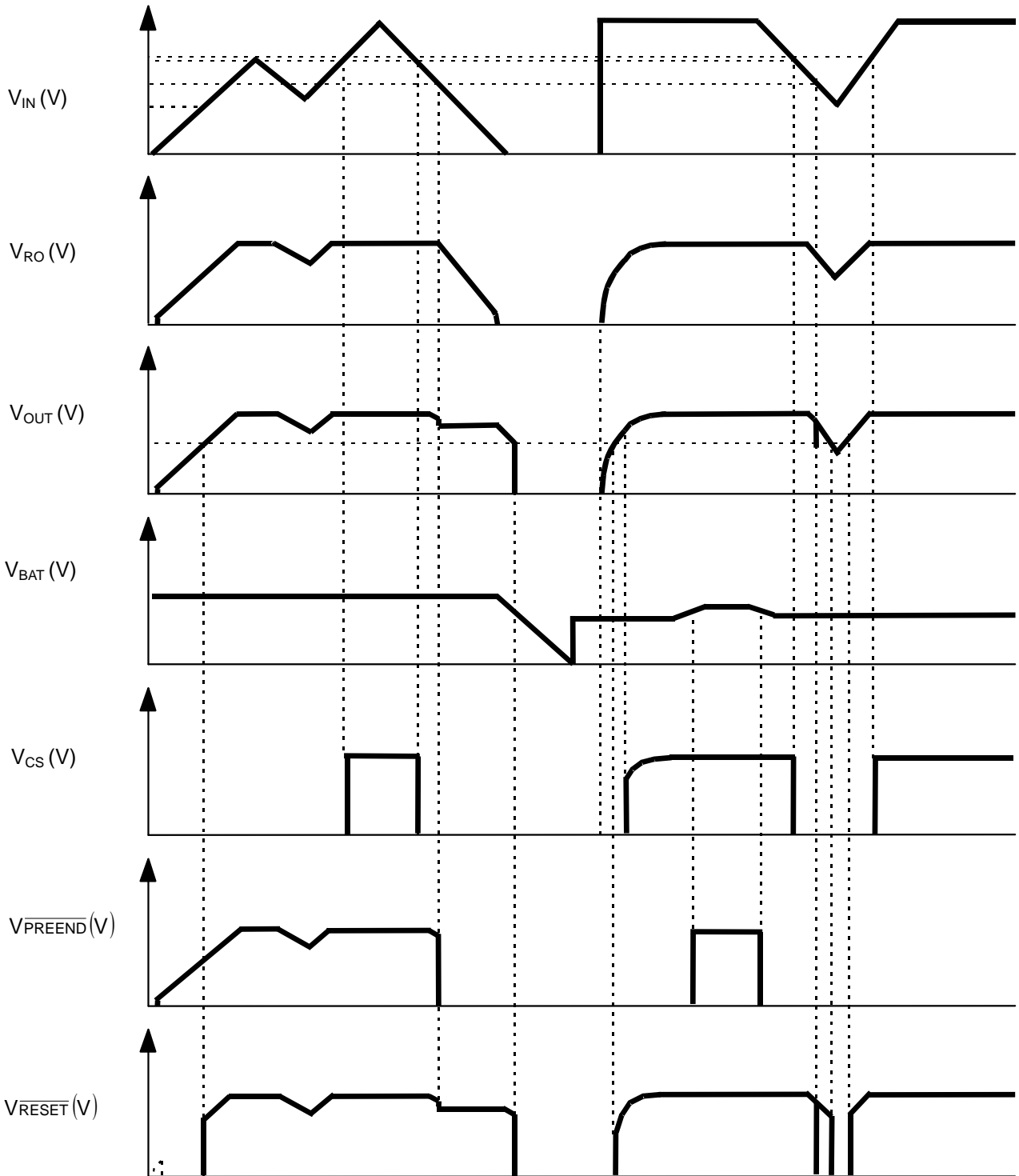

**Remark** CS,  $\overline{PREEND}$  and  $\overline{RESET}$  are pulled up to  $V_{OUT}$ . Y-axis is an arbitrary scale.

Figure 6 Operation Timing Chart

## ■ Operation

The internal configuration of the S-8424A Series is as follows.

- Voltage regulator 1, which stabilizes input voltage ( $V_{IN}$ ) and outputs it to  $V_{RO}$
- Voltage regulator 2, which stabilizes input voltage ( $V_{IN}$ ) and outputs it to  $V_{OUT}$
- CS voltage detector, which monitors input voltage ( $V_{IN}$ )
- $\overline{PREEND}$  voltage detector, which monitors output voltage ( $V_{BAT}$ )
- $\overline{RESET}$  voltage detector, which monitors output voltage ( $V_{OUT}$ )
- Switch unit

The functions and operations of the above-listed elements are described below.

### 1. Voltage Regulators

The S-8424A Series features on-chip voltage regulators with a small dropout voltage. The voltage of the VRO and VOUT pins (the output pins of the voltage regulator) can separately be selected for the output voltage in 0.1 V steps between the range of 2.3 to 5.4 V.

#### [Dropout voltage $V_{drop1}$ , $V_{drop2}$ ]

Assume that the voltage output from the VRO pin is  $V_{RO(E)}$  under the conditions of output voltage 1 described in the electrical characteristics table.  $V_{IN1}$  is defined as the input voltage at which output voltage from the VRO pin becomes 98% of  $V_{RO(E)}$  when the input voltage  $V_{IN}$  is decreased. Then, the dropout voltage  $V_{drop1}$  is calculated by the following expression.

$$V_{drop1} = V_{IN1} - V_{RO(E)} \times 0.98$$

Similarly, assume that the voltage of the VOUT pin is  $V_{OUT(E)}$  under the conditions of output voltage 2 described in the electrical characteristics table.  $V_{IN2}$  is defined as the input voltage at which the output voltage from the VOUT pin becomes 98% of  $V_{OUT(E)}$ . Then, the dropout voltage  $V_{drop2}$  is calculated by the following expression.

$$V_{drop2} = V_{IN2} - V_{OUT(E)} \times 0.98$$

### 2. Voltage Detector

The S-8424A Series incorporates three high-precision, low power consuming voltage detectors with hysteresis characteristics. The power of the CS voltage detector is supplied from the VIN and VBAT pins. Therefore, the output is stable as long as the primary or backup power supplies are within the operating voltage range (1.7 to 16 V). All outputs are Nch open-drain, and need pull-up resistors of about 100 k $\Omega$ .

#### 2.1 CS Voltage Detector

The CS voltage detector monitors the input voltage  $V_{IN}$  (VIN pin voltage). The detection voltage can be selected from between 2.4 and 5.3 V in 0.1 V steps. The result of detection is output at the CS pin: "Low" for lower voltage than the detection level and "High" for higher voltage than the release level (however, when the VOUT pin voltage is the CS output inhibit voltage ( $V_{SW2}$ ), a low level is output).

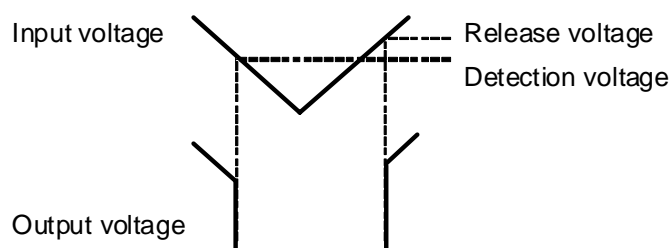

Figure 7 Definition of Detection and Release Voltages

**2.2  $\overline{\text{PREEND}}$  Voltage Detector**

The  $\overline{\text{PREEND}}$  voltage detector monitors the input voltage  $V_{\text{BAT}}$  (VBAT pin voltage). The detection voltage can be selected from between 1.7 V and 3.4 V in 0.1 V steps. A higher voltage can also be selected keeping a constant difference with the  $\overline{\text{RESET}}$  voltage. This function enables the warning that the backup battery is running out. The detection result is output to the  $\overline{\text{PREEND}}$  pin: “Low” for lower voltages than the detection voltage and “High” for higher voltages than the release voltage. The power supply of the  $\overline{\text{PREEND}}$  voltage detector is supplied from the VIN pin. The output is valid only when the voltage is supplied from the VIN pin to the VOUT pin ( $V_{\text{IN}} \geq V_{\text{SW1}}$ ). The output is the low level when the voltage is supplied from the VBAT pin to the VOUT pin ( $V_{\text{IN}} < V_{\text{SW1}}$ ).

**2.3  $\overline{\text{RESET}}$  Voltage Detector**

The  $\overline{\text{RESET}}$  voltage detector monitors the output voltage  $V_{\text{OUT}}$  (VOUT pin voltage). The detection voltage can be selected from between 1.7 V and 3.4 V in 0.1 V steps. The result of detection is output at the  $\overline{\text{RESET}}$  pin: “Low” for lower voltages than the detection level and “High” for higher voltages than the release level.  $\overline{\text{RESET}}$  outputs the normal logic if the VOUT pin voltage is 1.0 V or more.

**Caution** The  $\overline{\text{PREEND}}$  and  $\overline{\text{RESET}}$  voltage detectors use the different pins, respectively. Practically, the current is taken from the VBAT side, and consider the I/O voltage difference ( $V_{\text{dif}}$ ) of M1 when M1 is ON.

**3. Switch Unit**

The switch unit consists of the  $V_{\text{SW1}}$  and  $V_{\text{SW2}}$  detectors, a switch controller, voltage regulator 2, and switch transistor M1 (Refer to “Figure 8 Switch Unit”).

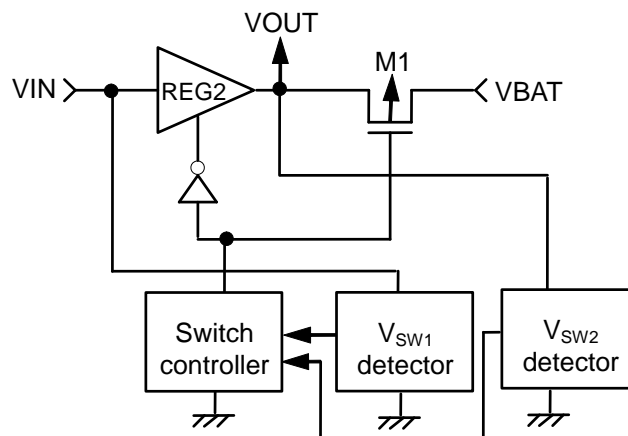

**Figure 8 Switch Unit**

**3.1  $V_{\text{SW1}}$  Detector**

The  $V_{\text{SW1}}$  detector monitors the power supply voltage  $V_{\text{IN}}$  and sends the results of detection to the switch controller. The detection voltage ( $V_{\text{SW1}}$ ) can be set to  $77 \pm 2\%$  or  $85 \pm 2\%$  of the CS release voltage  $+V_{\text{DET1}}$ .

### 3.2 $V_{SW2}$ Detector

The  $V_{SW2}$  detector monitors the VOUT pin voltage and keeps the CS release voltage output low until the VOUT pin voltage rises to  $V_{SW2}$  voltage. The CS pin output then changes from low to high if the VIN pin voltage is more than the CS release voltage ( $+V_{DET1}$ ) when the VOUT pin voltage rises to  $95 \pm 2\%$  of the output voltage of voltage regulator 2 ( $V_{OUT}$ ). The CS pin output changes from high to low regardless of the  $V_{SW2}$  voltage when the VIN pin voltage drops to less than the CS detection voltage ( $-V_{DET1}$ ). The CS pin output remains high if the VIN pin voltage stays higher than the CS detection voltage ( $-V_{DET1}$ ) when the VOUT pin voltage drops to less than the  $V_{SW2}$  voltage due to an undershoot.

### 3.3 Switch Controller

The switch controller controls voltage regulator 2 and switch transistor M1. There are two statuses corresponding to the power supply voltage  $V_{IN}$  (or power supply voltage  $V_{BAT}$ ) sequence: a special sequence status and a normal sequence status. When the power supply voltage  $V_{IN}$  rises and becomes equal to or exceeds the CS release voltage ( $+V_{DET1}$ ), the normal sequence status is entered, but until then the special sequence status is maintained.

#### (1) Special sequence status

The switch controller sets voltage regulator 2 ON and switch transistor M1 OFF from the initial status until the primary power supply voltage  $V_{IN}$  is connected and reaches more than the CS release voltage ( $+V_{DET1}$ ) in order to prevent consumption of the backup power supply regardless of the  $V_{SW1}$  detector status. This status is called the special sequence status.

#### (2) Normal sequence status

The switch controller enters the normal sequence status from the special sequence status once the primary power supply voltage  $V_{IN}$  reaches more than the CS release voltage ( $+V_{DET1}$ ).

Once the normal sequence is entered, the switch controller switches voltage regulator 2 and switch transistor M1 ON/OFF as shown in **Table 14** according to the power supply voltage  $V_{IN}$ . The time required for voltage regulator 2 to be switched from OFF to ON is a few hundred  $\mu\text{s}$  at most. During this interval, voltage regulator 2 and switch transistor M1 may both switch OFF and the VOUT pin voltage may drop. To prevent this, connect a capacitor of 10  $\mu\text{F}$  or more to the VOUT pin.

When the VOUT pin voltage becomes lower than the  $\overline{\text{RESET}}$  detection voltage, the status returns to the special sequence status.

**Table 14 ON/OFF Switching of Voltage Regulator 2 and Switch Transistor M1 According to Power Supply Voltage ( $V_{IN}$ )**

Power Supply Voltage ( $V_{IN}$ )	Voltage Regulator 2	Switch Transistor M1	VOUT Pin Voltage
$V_{IN} > V_{SW1}$	ON	OFF	$V_{OUT}$
$V_{IN} < V_{SW1}$	OFF	ON	$V_{BAT} - V_{dif}$

### 3.4 Switch Transistor M1

Voltage regulator 2 is also used to switch from VIN pin to VOUT pin. Therefore, no reverse current flows from VOUT pin to VIN pin when voltage regulator 2 is OFF. The output voltage of voltage regulator 2 can be selected from between 2.3 V and 5.4 V in 0.1 V steps.

The on-resistance of switch transistor M1 is 60  $\Omega$  or lower ( $I_{OUT} = 10$  to 500  $\mu\text{A}$ ).

Therefore, when M1 is switched ON and VOUT pin is connected to VBAT pin, the voltage drop ( $V_{dif}$ ) caused by M1 is  $60 \times I_{OUT}$  (output current) at maximum., and  $V_{BAT} - V_{dif}$  (max.) is output to the VOUT pin at minimum.

When voltage regulator 2 is ON and M1 is OFF, the leakage current of M1 is kept below 0.1  $\mu\text{A}$  max. ( $V_{IN} = 6$  V,  $T_a = 25^\circ\text{C}$ ) with the VBAT pin grounded (VSS pin).

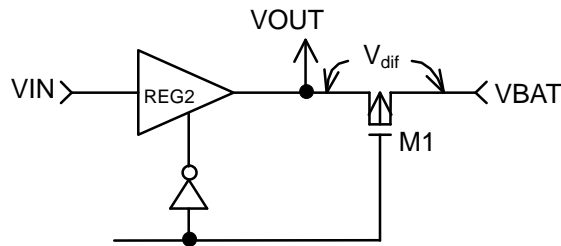

Figure 9 Definition of  $V_{dif}$

■ Transient Response

1. Line Transient Response Against Input Voltage Variation

The input voltage variation differs depending on whether the power supply input (0 V to 10 V square wave) is applied or the power supply variation (6 V and 10 V square waves) is applied. This section describes the ringing waveforms and parameter dependency of each type. The test circuit is shown for reference.

Power supply application: 0 V to 10 V Square wave

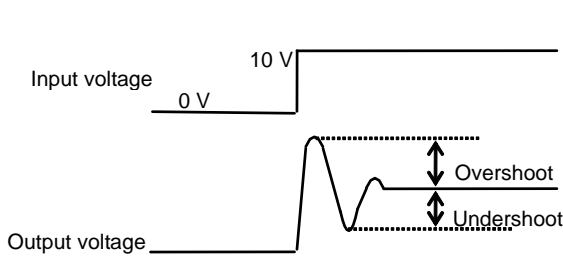

Figure 10 Power Supply Application: 0 V to 10 V Square Wave

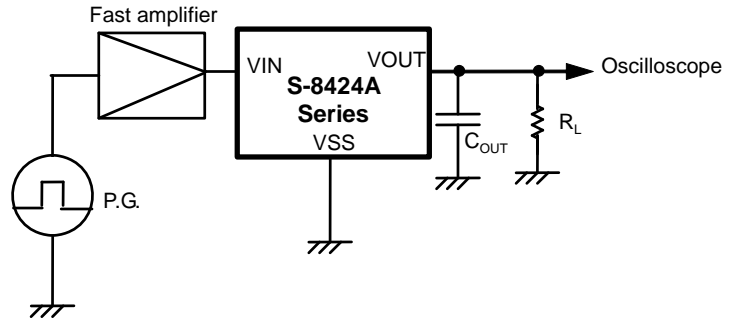

Figure 11 Test Circuit

Power Supply Application

VOUT pin

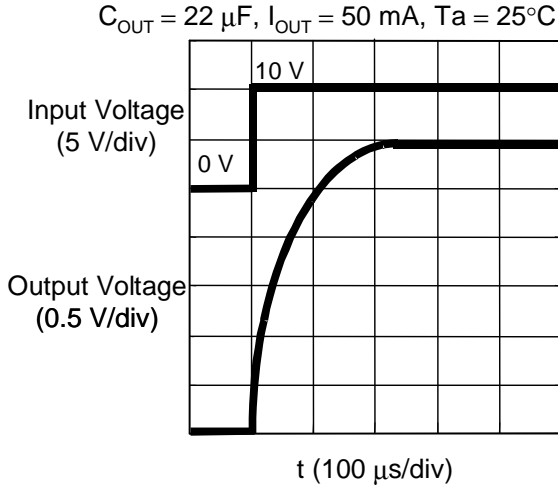

Figure 12 Ringing Waveform of Power Supply Application (VOUT Pin)

VRO pin

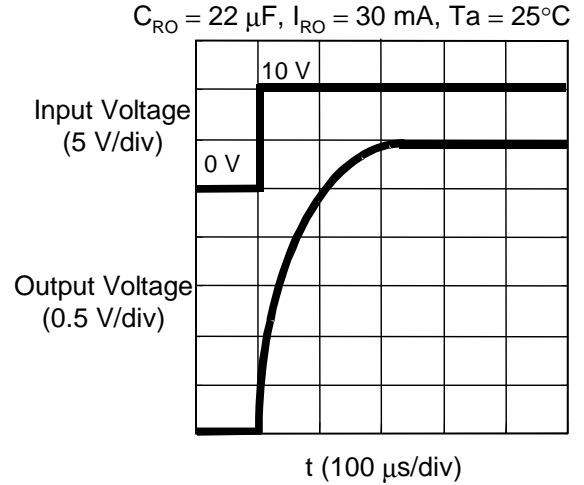
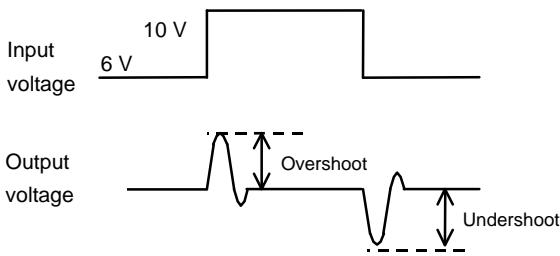
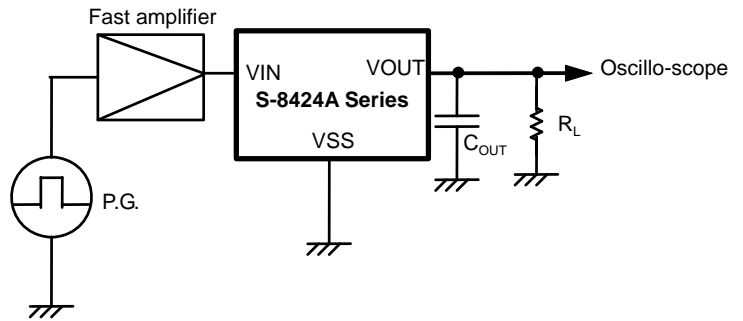

Figure 13 Ringing Waveform of Power Supply Application (VRO Pin)

Power supply variation: 6 V and 10 V square waves



**Figure 14 Power Supply Variation:  
6 V and 10 V Square Waves**



**Figure 15 Test Circuit**

**Power Supply Variation**

**VOUT pin**

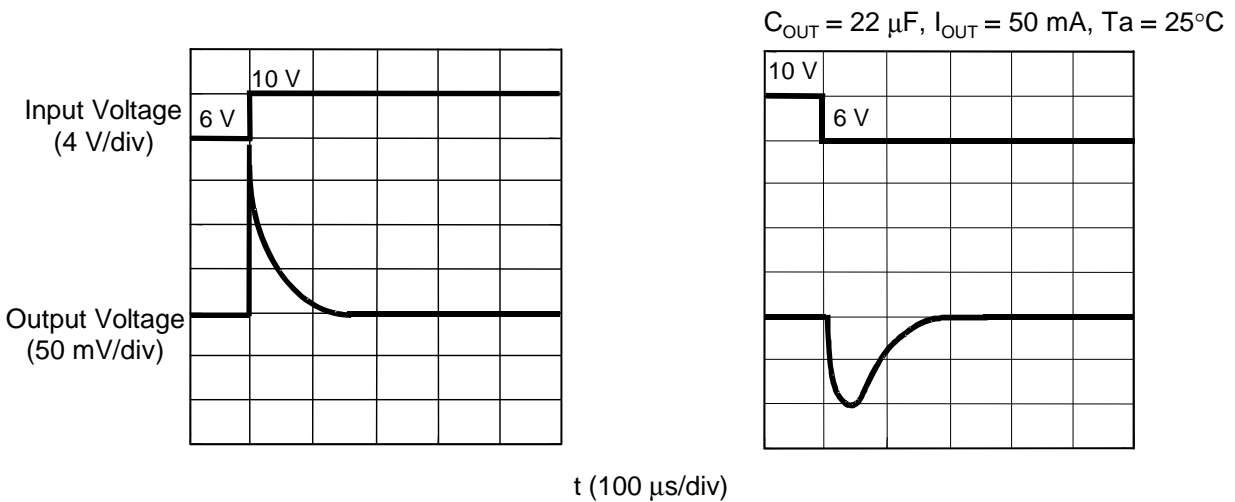

**Figure 16 Ringing Waveform of Power Supply Variation (VOUT Pin)**

**VRO pin**

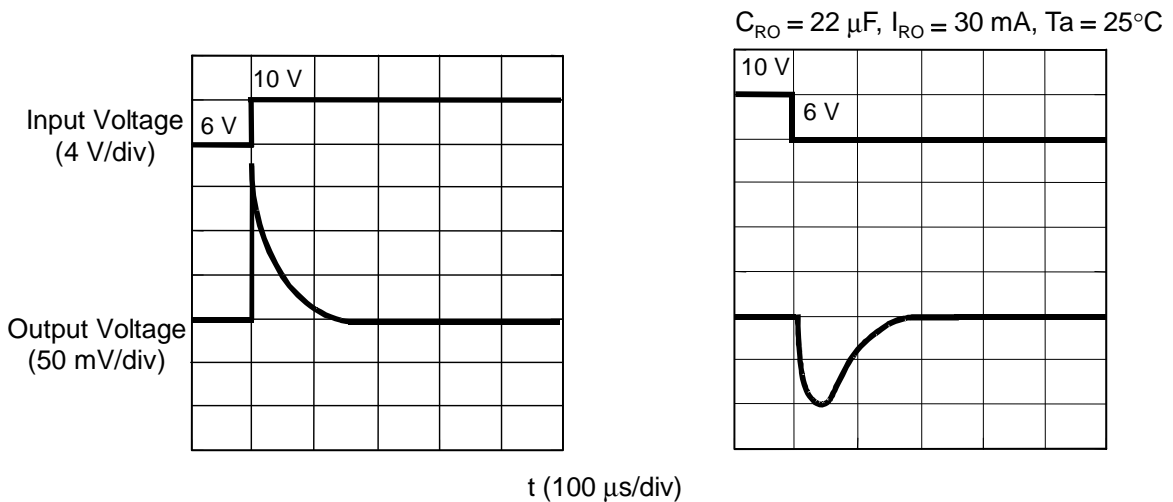

**Figure 17 Ringing Waveform of Power Supply Variation (VRO Pin)**



Reference data: Dependency of output current ( $I_{OUT}$ ), load capacitance ( $C_{OUT}$ ), input variation width ( $\Delta V_{IN}$ ), temperature ( $T_a$ )

For reference, the following pages describe the results of measuring the ringing amounts at the VOUT and VRO pins using the output current ( $I_{OUT}$ ), load capacitance ( $C_{OUT}$ ), input variation width ( $\Delta V_{IN}$ ), and temperature ( $T_a$ ) as parameters.

**1.1  $I_{OUT}$  Dependency**

**(1) VOUT pin**

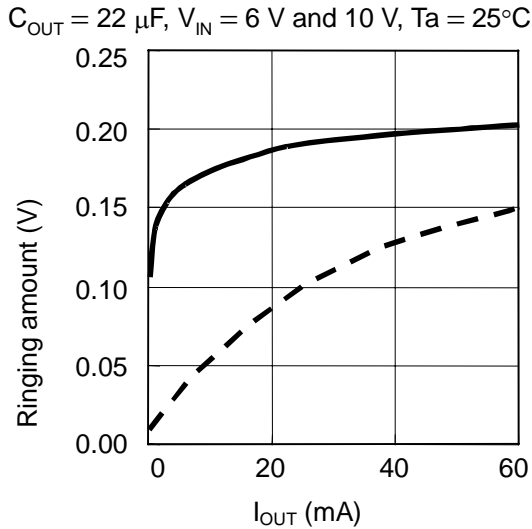

**(2) VRO pin**

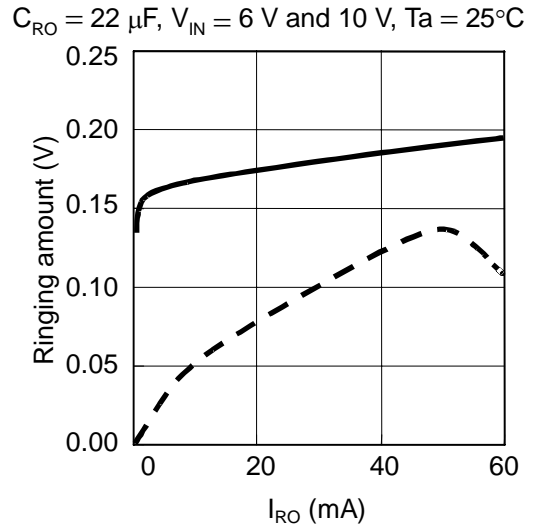

**1.2  $C_{OUT}$  Dependency**

**(1) VOUT pin**

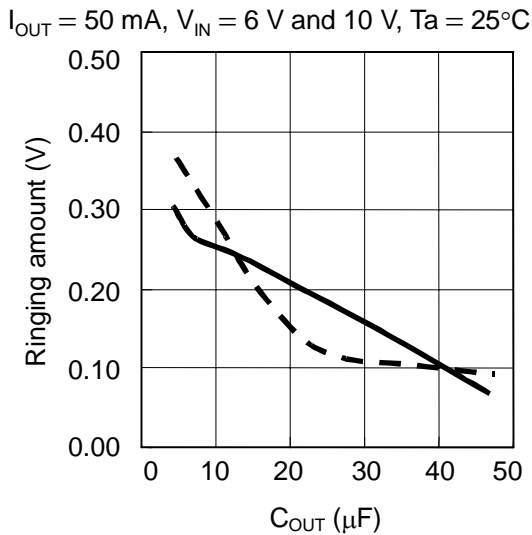

**(2) VRO pin**

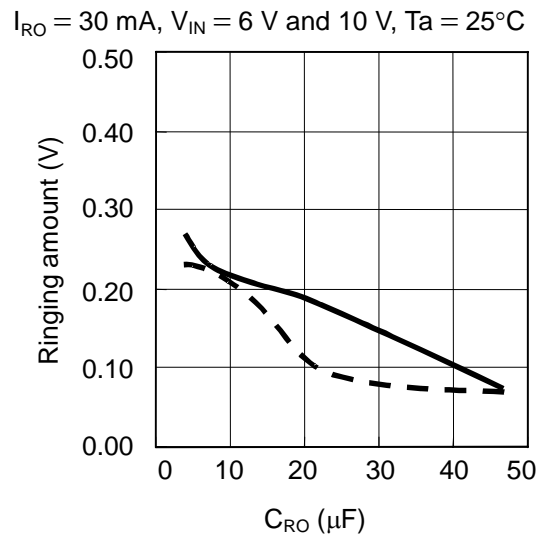

— Overshoot  
 - - Undershoot

1.3  $\Delta V_{IN}$  Dependency

$\Delta V_{IN}$  shows the difference between the low voltage fixed to 6 V and the high voltage.  
 For example,  $\Delta V_{IN} = 2$  V means the difference between 6 V and 8 V.

(1) VOUT pin

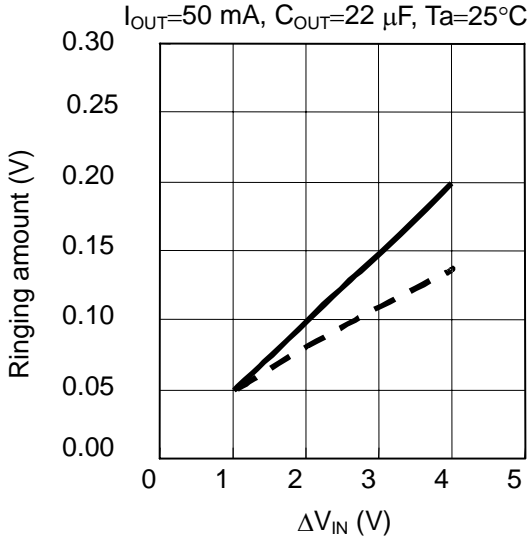

(2) VRO pin

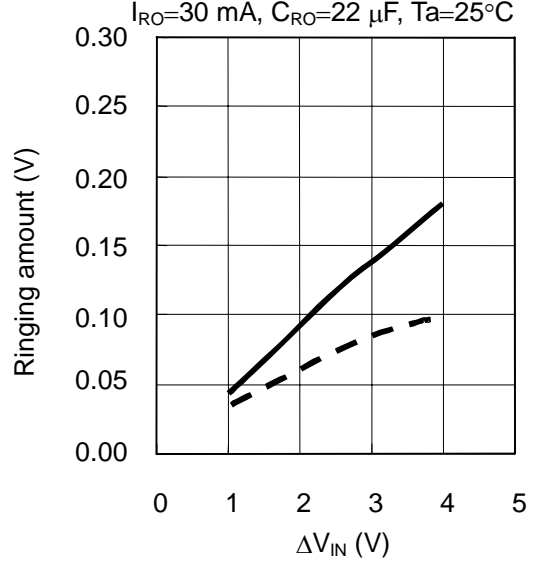

1.4 Temperature Dependency

(1) VOUT pin

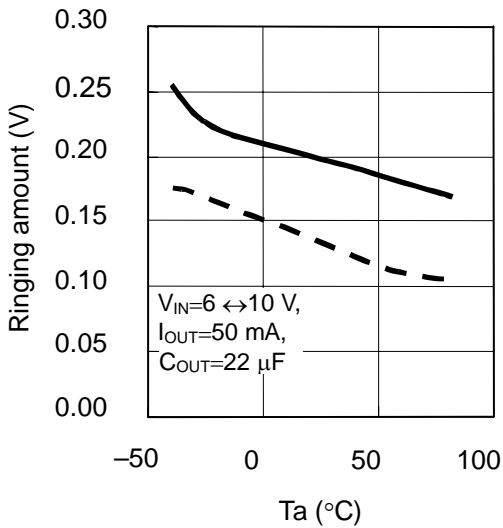

(2) VRO pin

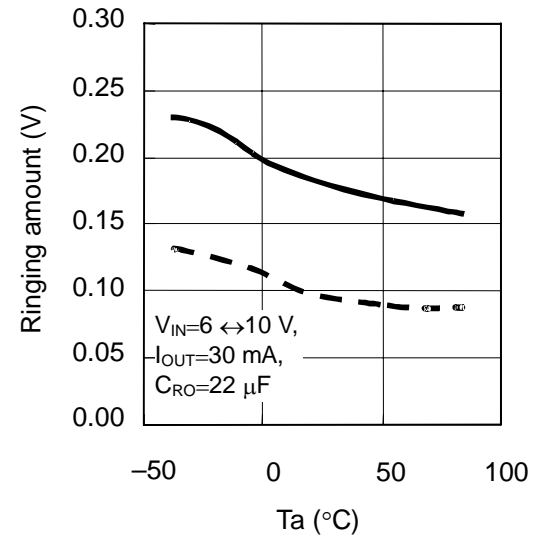

— Overshoot  
 - - - Undershoot

2. Load Transient Response Based on Output Current Fluctuation

The overshoot and undershoot are caused in the output voltage if the output current fluctuates between 10  $\mu$ A and 50 mA ( $V_{RO}$  is between 10  $\mu$ A and 30 mA) while the input voltage is constant. **Figure 18** shows the output voltage variation due to the output current. **Figure 19** shows the test circuit for reference. The latter half of this section describes ringing waveform and parameter dependency.

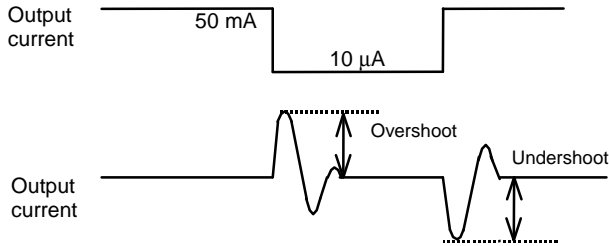

Figure 18 Output Voltage Variation due to Output Current

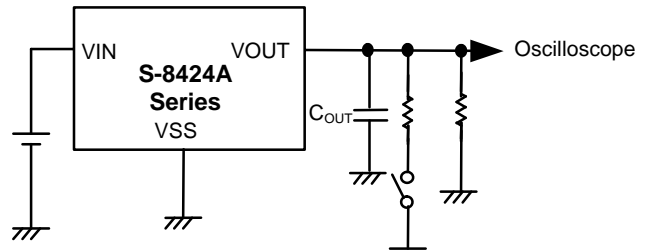
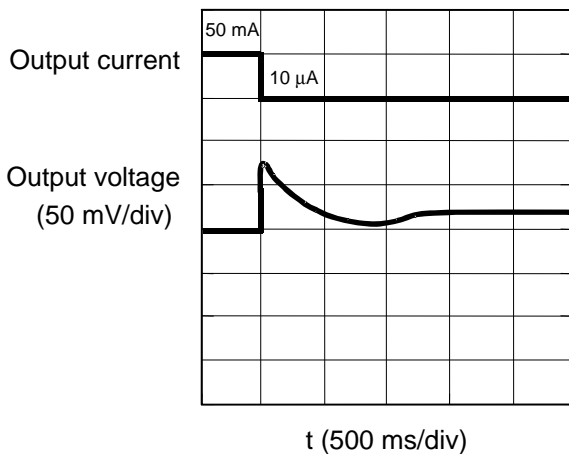

Figure 19 Test Circuit

**Figure 20** shows the ringing waveforms at the VOUT pin and **Figure 21** shows the ringing waveforms at the VRO pin due to the load variation, respectively.

VOUT pin



$V_{IN} = 6.0 \text{ V}, C_{OUT} = 22 \mu\text{F}, T_a = 25^\circ\text{C}$

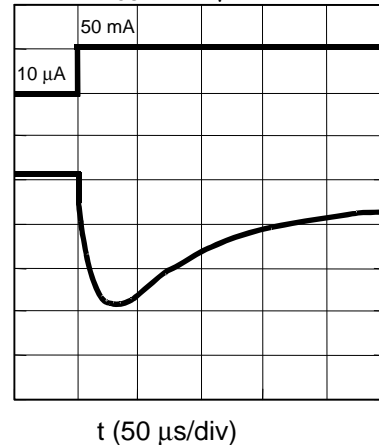
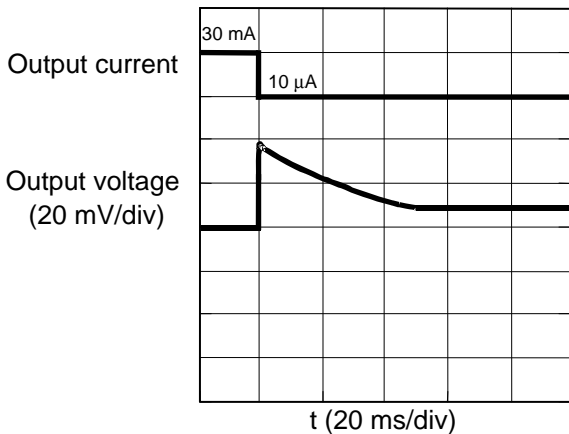

Figure 20 Ringing Waveform due to Load Variation (VOUT Pin)

VRO pin



$V_{IN}=6.0 \text{ V}, C_{RO}=22 \mu\text{F}, T_a=25^\circ\text{C}$

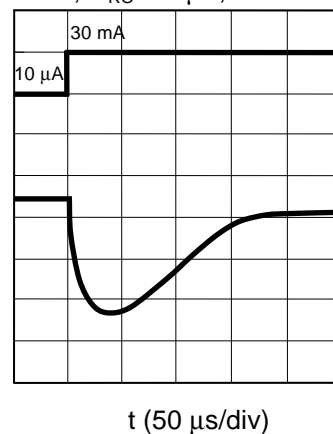

Figure 21 Ringing Waveform due to Load Variation (VRO Pin)

Reference data: Dependency of input voltage ( $V_{IN}$ ), load capacitance ( $C_{OUT}$ ), output variation width ( $\Delta I_{OUT}$ ), and temperature ( $T_a$ )

2.1  $V_{IN}$  Dependency

(1)  $V_{OUT}$  pin

$C_{OUT} = 22 \mu F$ ,  $I_{OUT} = 50 \text{ mA}$  and  $10 \mu A$ ,  $T_a = 25^\circ C$

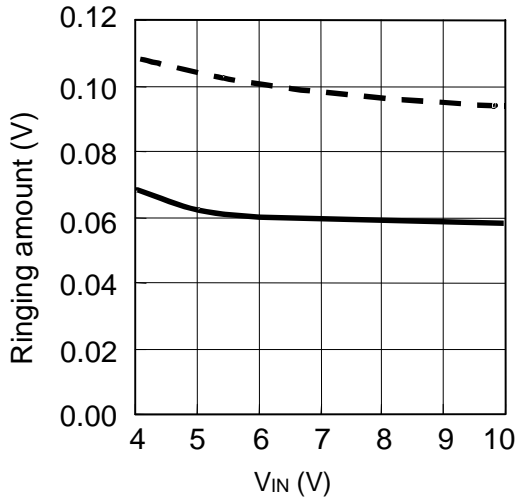

(2)  $V_{RO}$  pin

$C_{RO} = 22 \mu F$ ,  $I_{RO} = 30 \text{ mA}$  and  $10 \mu A$ ,  $T_a = 25^\circ C$

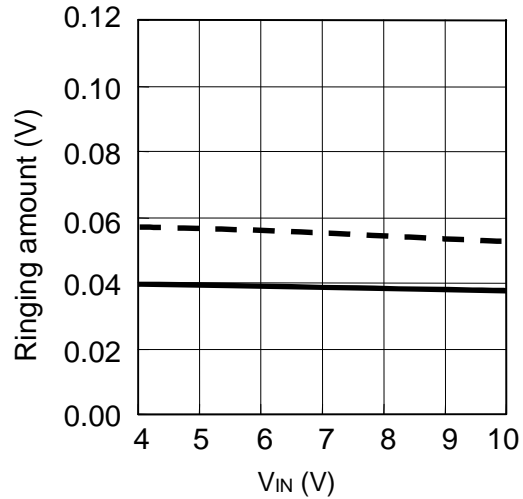

2.2  $C_{OUT}$  Dependency

(1)  $V_{OUT}$  pin

$V_{IN} = 6.0 \text{ V}$ ,  $I_{OUT} = 50 \text{ mA}$  and  $10 \mu A$ ,  $T_a = 25^\circ C$

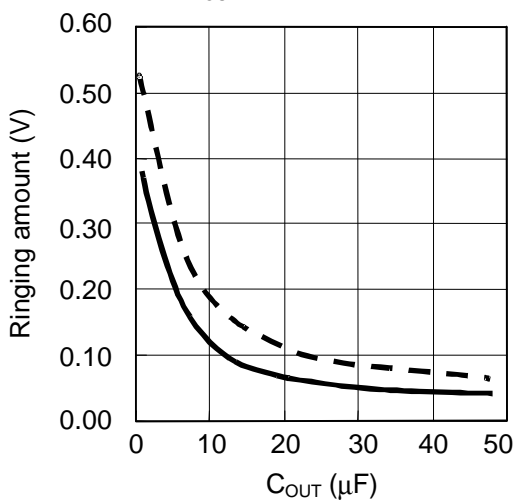

(2)  $V_{RO}$  pin

$V_{IN} = 6.0 \text{ V}$ ,  $I_{RO} = 30 \text{ mA}$  and  $10 \mu A$ ,  $T_a = 25^\circ C$

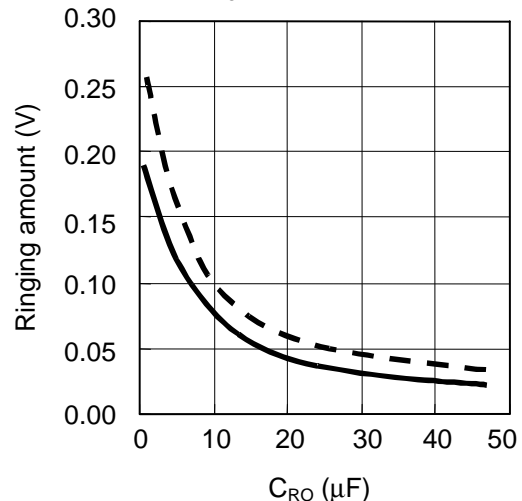

— Overshoot  
 - - Undershoot

2.3  $\Delta I_{OUT}$  Dependency

$\Delta I_{OUT}$  and  $\Delta I_{RO}$  show the fluctuation between the low current stabilized at 10  $\mu A$  and the high current. For example,  $\Delta I_{OUT} = 10 \text{ mA}$  means a fluctuation between 10  $\mu A$  and 10 mA.

(1) VOUT pin

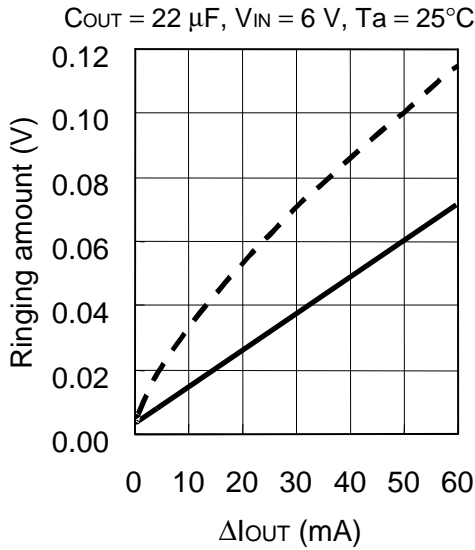

(2) VRO pin

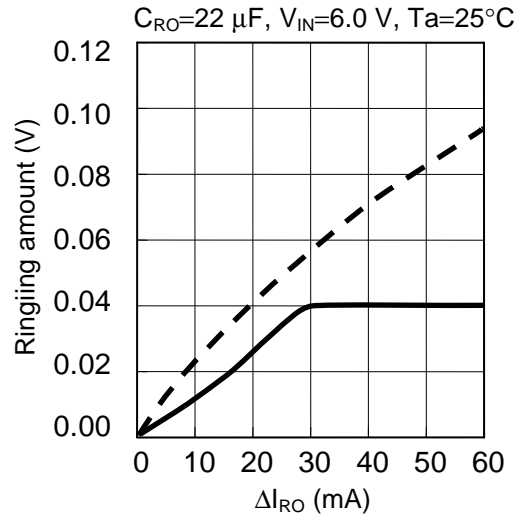

2.4 Temperature Dependency

(1) VOUT pin

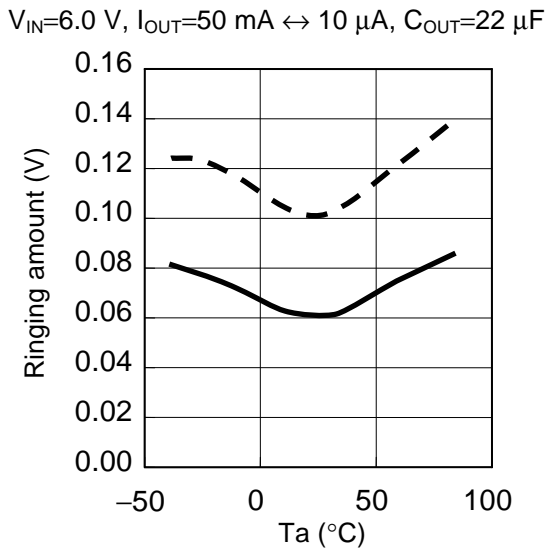

(2) VRO pin

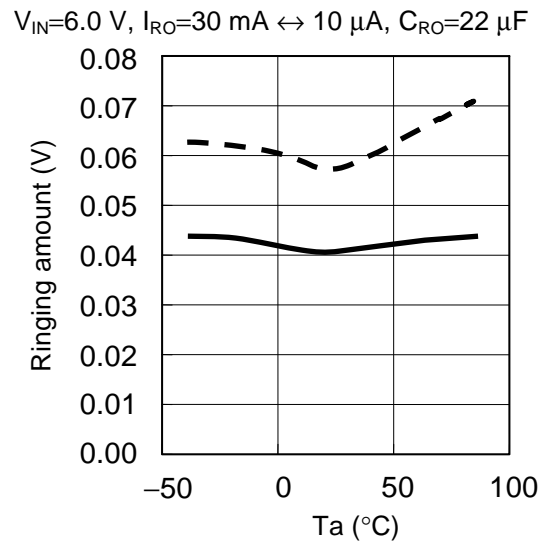

— Overshoot  
- - - Undershoot

■ Standard Circuit

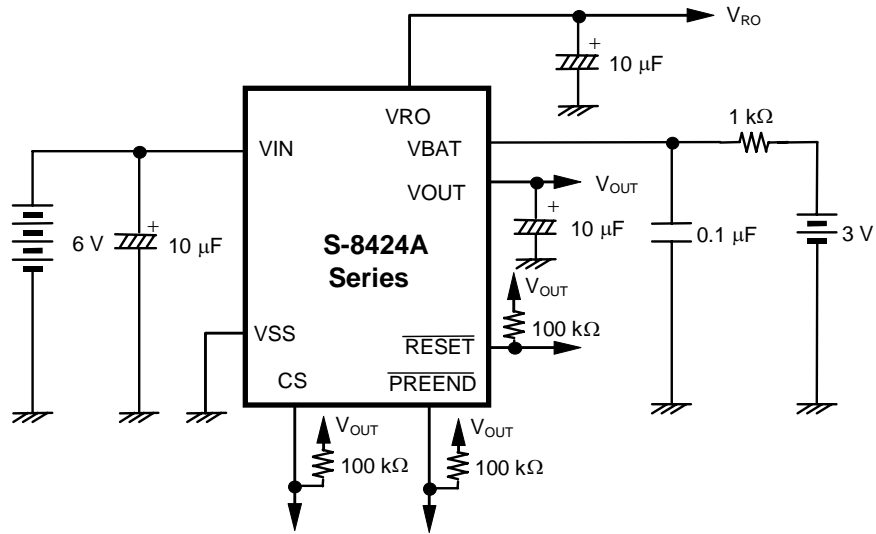

Figure 22 Standard Circuit

- Caution 1.** Be sure to add a 10  $\mu\text{F}$  or more capacitor to the VOUT and VRO pins.
- 2.** The above connections and values will not guarantee correct operation. Before setting these values, perform sufficient evaluation on the application to be actually used.

## ■ Precautions

- In applications with small  $I_{RO}$  or  $I_{OUT}$ , the output voltages  $V_{RO}$  and  $V_{OUT}$  may rise, causing the load stability to exceed standard levels. Set  $I_{RO}$  and  $I_{OUT}$  to 10  $\mu\text{A}$  or more.
- Attach the proper capacitor to the VOUT pin to prevent the  $\overline{\text{RESET}}$  voltage detector (which monitors the VOUT pin) from coming active due to undershoot.
- Watch for overshoot and ensure it does not exceed the ratings of the IC chips and/or capacitors attached to the VRO and VOUT pins.
- Add a 10  $\mu\text{F}$  or more capacitor to the VOUT and VRO pins.
- When  $V_{IN}$  rises from the voltage more than  $V_{SW1}$ , a low pulse of less than 4 ms flows through the  $\overline{\text{PREEND}}$  pin even when  $V_{BAT}$  is more than the  $\overline{\text{PREEND}}$  release voltage. Thus when monitoring the  $\overline{\text{PREEND}}$  pin, make sure to take the 4 ms interval or more after the rise of  $V_{IN}$ .
- Do not apply an electrostatic discharge to this IC that exceeds the performance ratings of the built-in electrostatic protection circuit.

## ■ Application Circuits

### 1. When Using Timer Micro controllers for Backup to display $\overline{\text{PREEND}}$ in the primary CPU

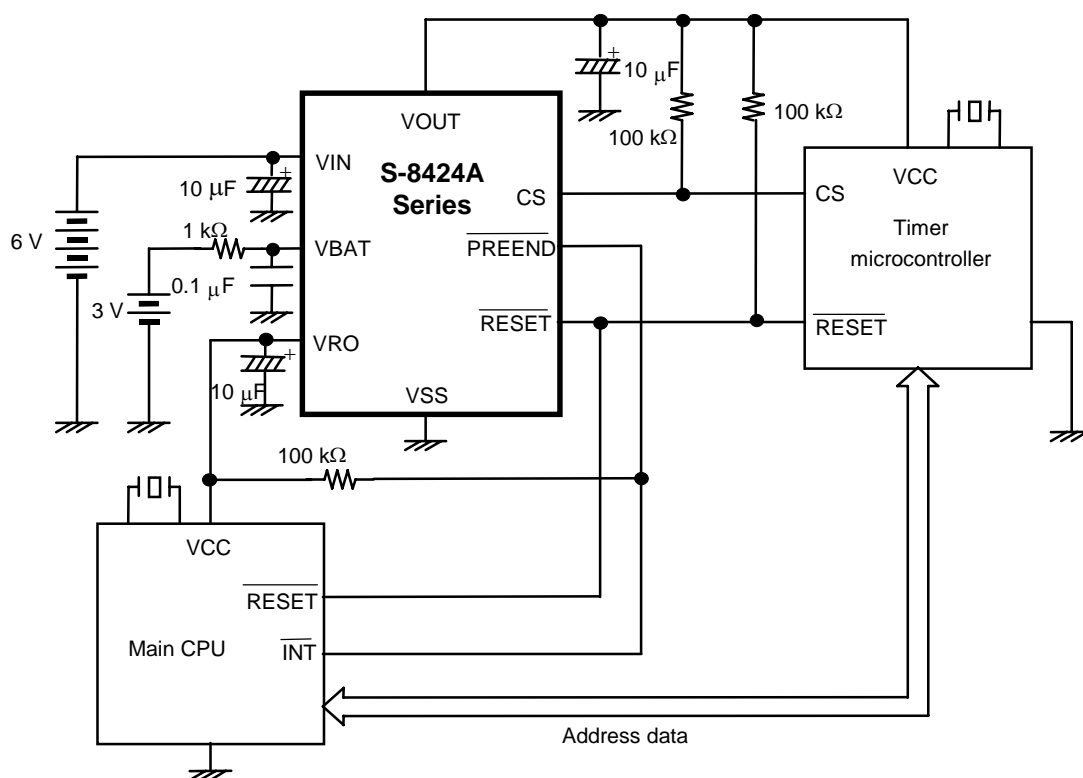

Figure 23 Application Circuit 1

2. When Using Secondary Battery as Backup Battery

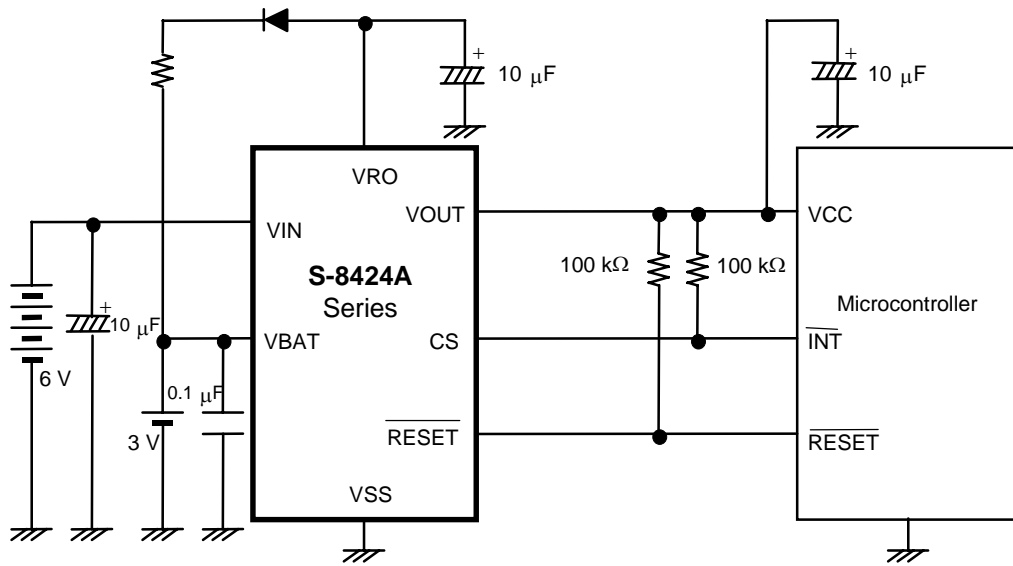

Figure 24 Application Circuit 2

**Remark** The backup battery can be floating-recharged by using voltage regulator 1.

3. Memory Card

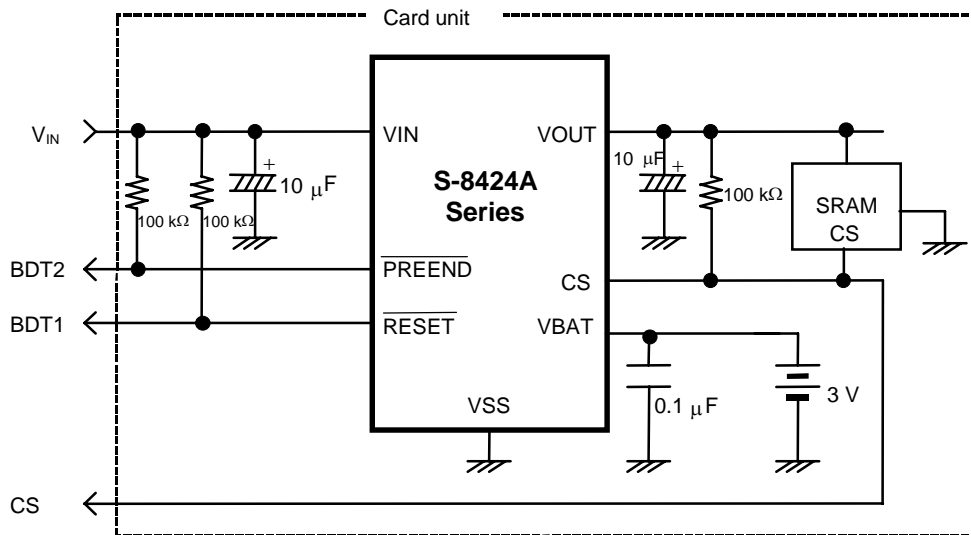

Figure 25 Application Circuit 3

**Caution** The above connections and values will not guarantee correct operation. Before setting these values, perform sufficient evaluation on the application to be actually used.



■ Characteristics

1. Voltage Regulator Unit ( $V_{RO} = V_{OUT} = 3.0\text{ V}$ )

1.1 Input Voltage ( $V_{IN}$ ) vs. Output Voltage ( $V_{RO}$ ) Characteristics (REG1)

(1)  $T_a = 85^\circ\text{C}$

$I_{RO} = 10\text{ mA}, 30\text{ mA}, 50\text{ mA}, 70\text{ mA}, 90\text{ mA}$

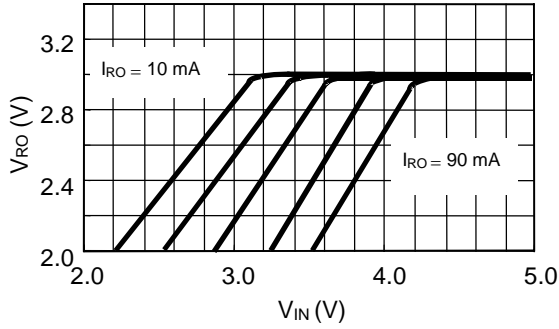

(2)  $T_a = 25^\circ\text{C}$

$I_{RO} = 10\text{ mA}, 30\text{ mA}, 50\text{ mA}, 70\text{ mA}, 90\text{ mA}$

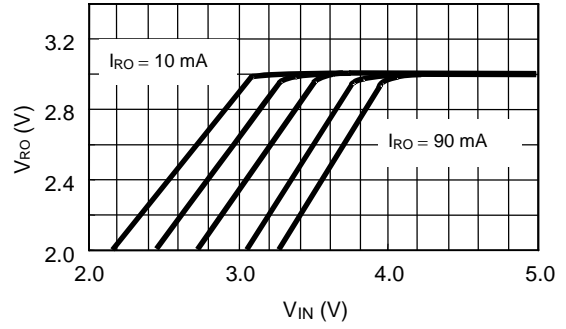

(3)  $T_a = -40^\circ\text{C}$

$I_{RO} = 10\text{ mA}, 30\text{ mA}, 50\text{ mA}, 70\text{ mA}, 90\text{ mA}$

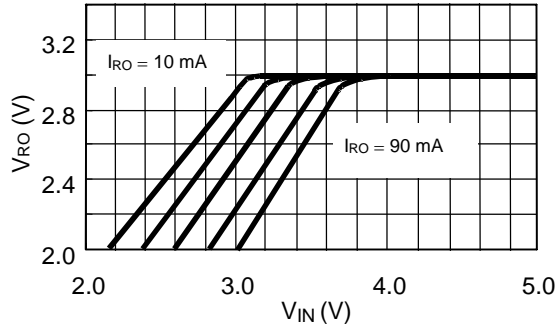

1.2 Input Voltage ( $V_{IN}$ ) vs. Output Voltage ( $V_{OUT}$ ) Characteristics (REG2)

(1)  $T_a = 85^\circ\text{C}$

$I_{OUT} = 10\text{ mA}, 30\text{ mA}, 50\text{ mA}, 70\text{ mA}, 90\text{ mA}$

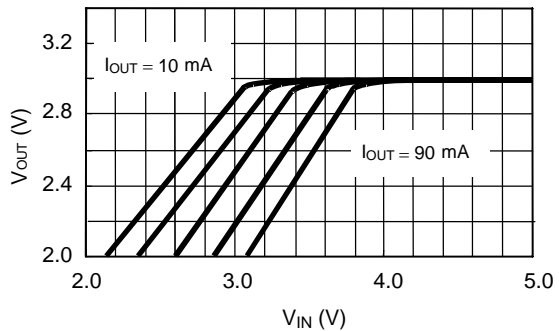

(2)  $T_a = 25^\circ\text{C}$

$I_{OUT} = 10\text{ mA}, 30\text{ mA}, 50\text{ mA}, 70\text{ mA}, 90\text{ mA}$

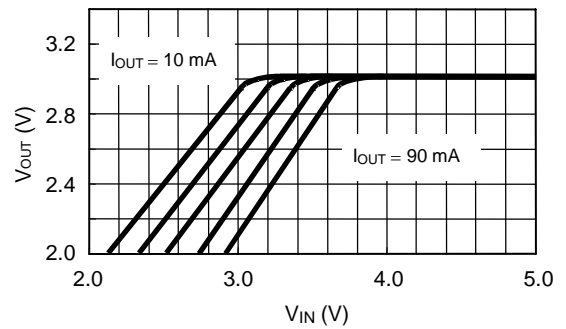

(3)  $T_a = -40^\circ\text{C}$

$I_{OUT} = 10\text{ mA}, 30\text{ mA}, 50\text{ mA}, 70\text{ mA}, 90\text{ mA}$

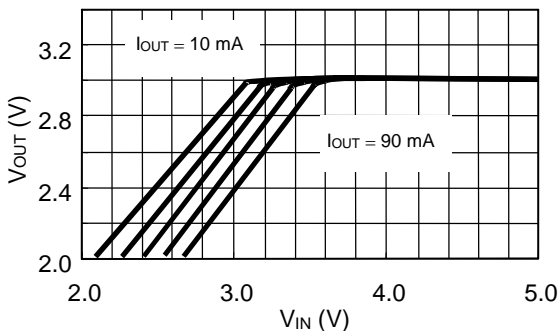

1.3 Output Current ( $I_{RO}$ ) vs. Dropout Voltage ( $V_{drop1}$ ) Characteristics

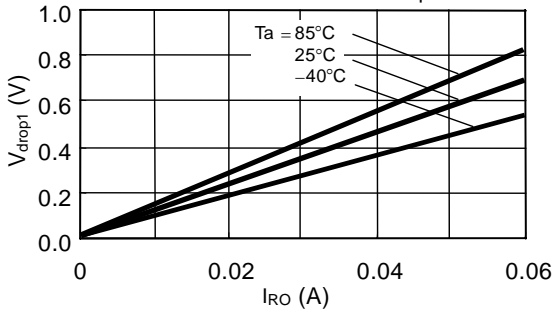

1.4 Output Current ( $I_{OUT}$ ) vs. Dropout Voltage ( $V_{drop2}$ ) Characteristics

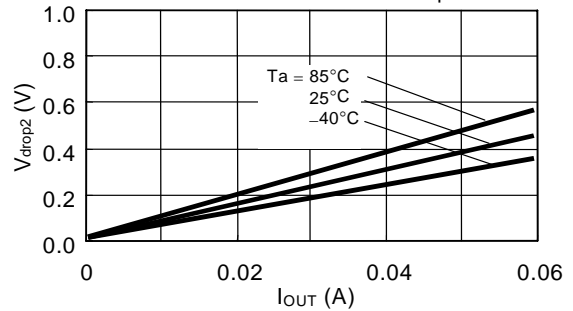

1.5 Output Current ( $I_{RO}$ ) vs. Output Voltage ( $V_{RO}$ ) Characteristics

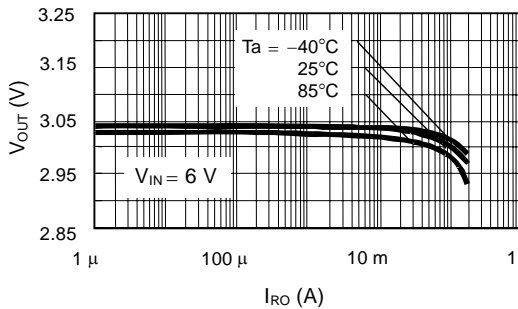

1.6 Output Current ( $I_{OUT}$ ) vs. Output Voltage ( $V_{OUT}$ ) Characteristics

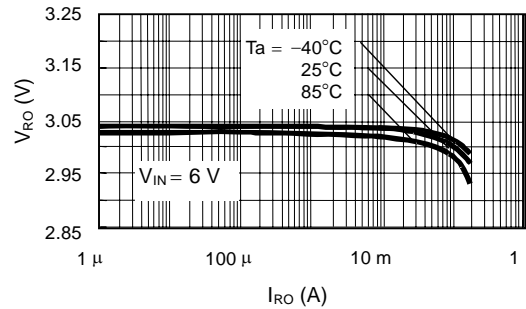

1.7 Output voltage ( $V_{RO}$ ) Temperature Characteristics

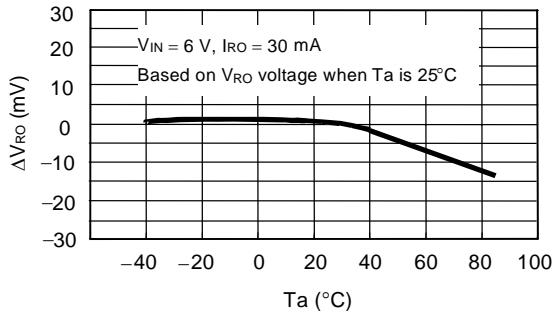

1.8 Output voltage ( $V_{OUT}$ ) Temperature Characteristics

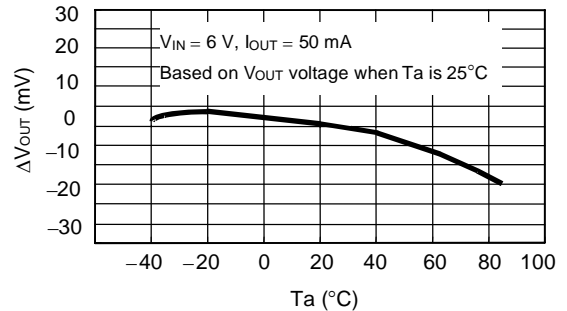

1.9 Input Stability ( $V_{RO}$ ) Temperature Characteristics

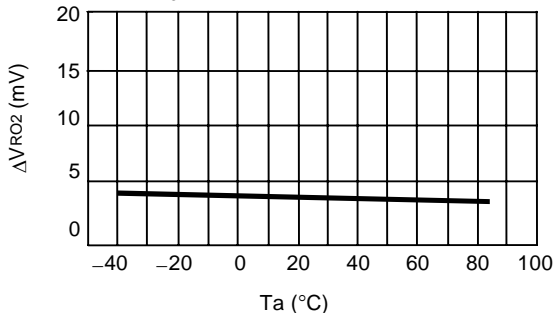

1.10 Input Stability ( $V_{OUT}$ ) Temperature Characteristics

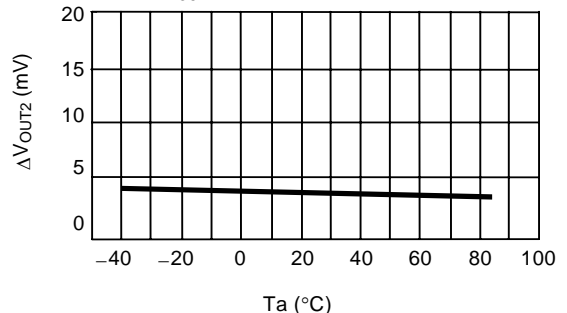

1.11 Load Stability ( $V_{RO}$ ) Temperature Characteristics

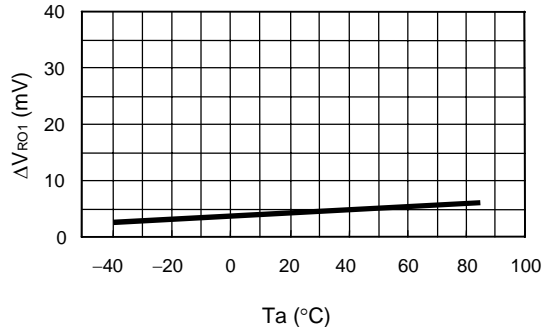

1.12 Load Stability ( $V_{RO}$ ) Temperature Characteristics

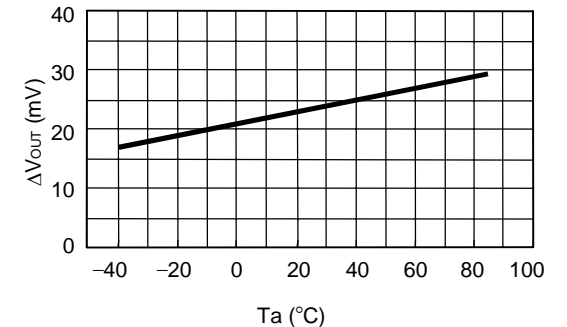

2. Voltage Detector

2.1 CS Voltage Detector ( $-V_{DET1} = 3.3\text{ V}$ )

(1) Detection voltage ( $-V_{DET1}$ ) temperature characteristics

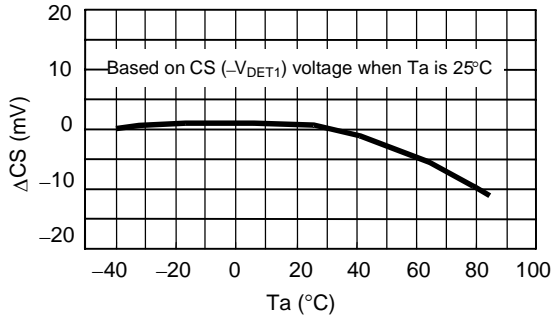

(2) Output current ( $I_{SINK}$ ) characteristics

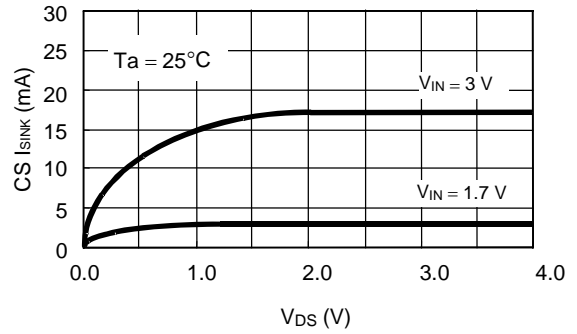

(3) Output current ( $I_{SINK}$ ) temperature characteristics

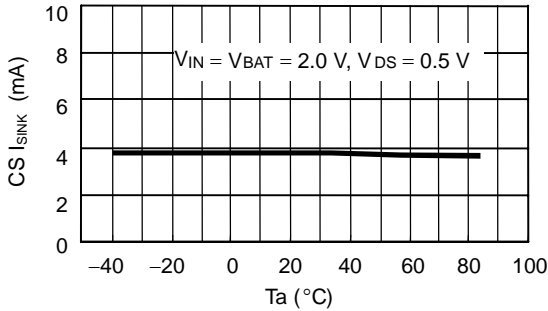

2.2 RESET Voltage Detector ( $-V_{DET2} = 2.2\text{ V}$ )

(1) Detection voltage ( $-V_{DET2}$ ) temperature characteristics

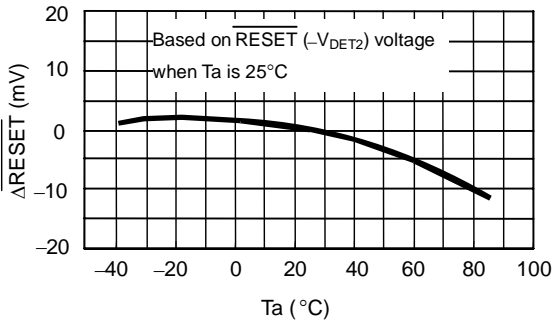

(2) Output current ( $I_{SINK}$ ) characteristics

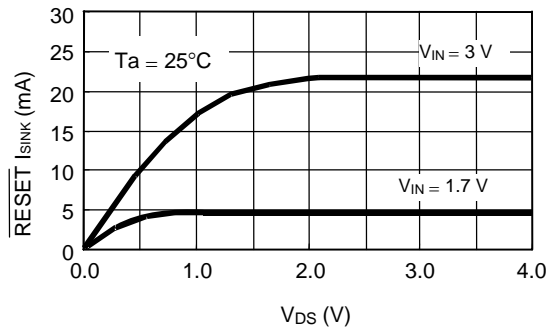

(3) Output current ( $I_{SINK}$ ) temperature characteristics

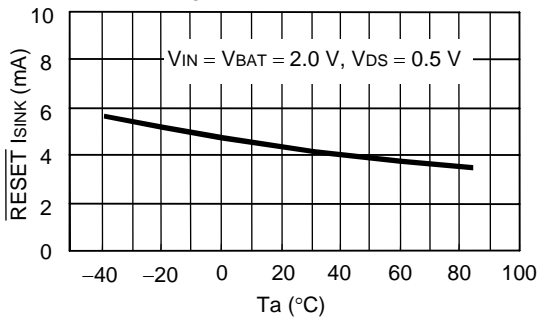

2.3 PREEND Voltage Detector ( $-V_{DET3} = 2.6\text{ V}$ )

(1) Detection voltage ( $-V_{DET3}$ ) temperature characteristics

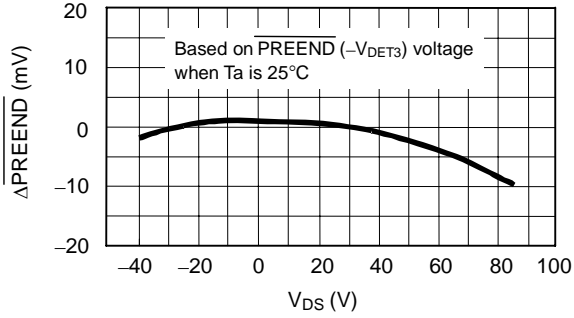

(2) Output current ( $I_{SINK}$ ) characteristics

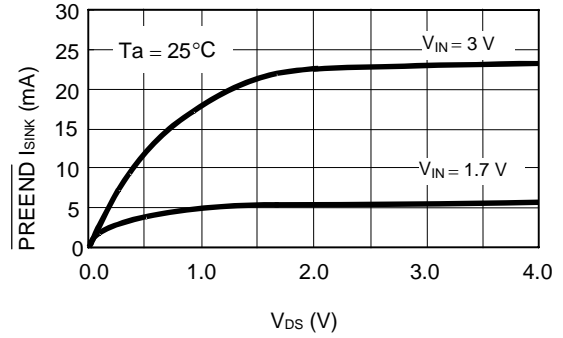

(3) Output current ( $I_{SINK}$ ) temperature characteristics

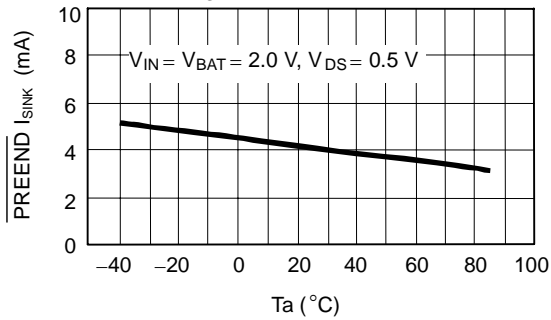

3. Switch Unit

3.1 Switch Voltage ( $V_{SW1}$ ) Temperature Characteristics

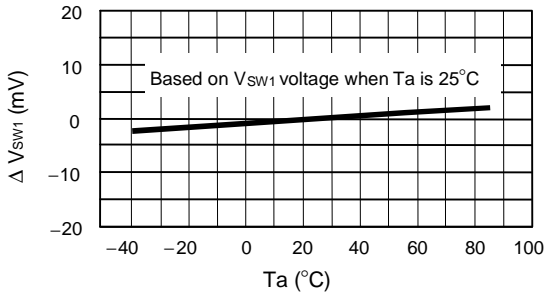

3.2 CS Output Inhibit Voltage ( $V_{SW2}$ ) Temperature Characteristics

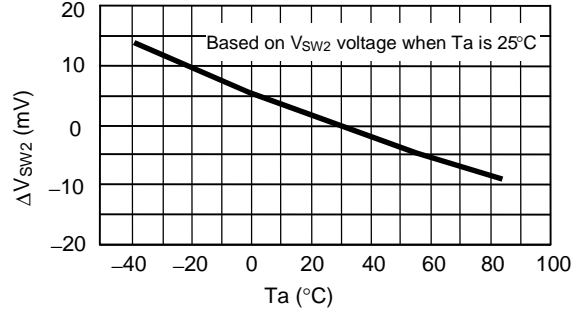

3.3 Input Voltage ( $V_{BAT}$ ) vs.  $V_{BAT}$  Switch Resistance ( $R_{SW}$ ) Characteristics

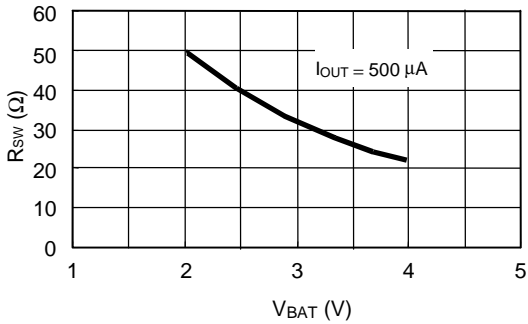

3.4  $V_{BAT}$  Switch Resistance ( $R_{SW}$ ) Temperature Characteristics

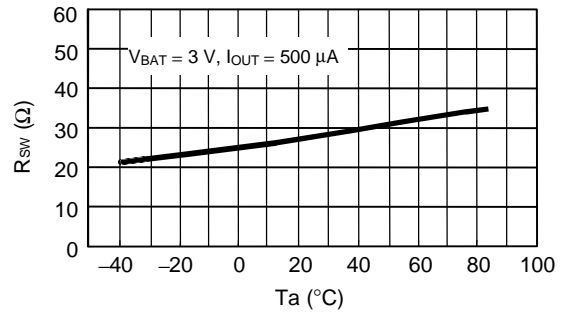

3.5  $V_{BAT}$  Switch Leakage Current ( $I_{LEAK}$ ) Temperature Characteristics

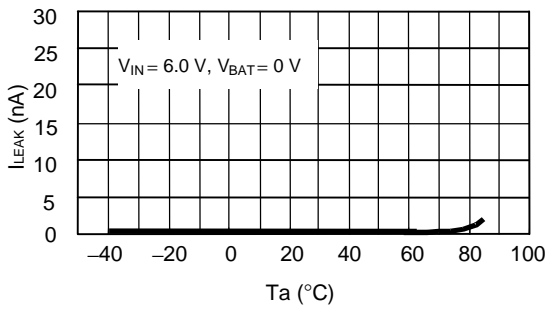

4. Consumption Current

4.1  $V_{IN}$  vs.  $I_{SS1}$  Consumption Current ( $I_{SS1}$ ) Characteristics

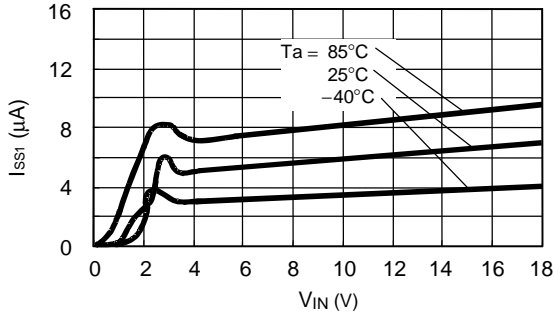

4.2  $V_{BAT}$  vs.  $I_{BAT2}$  Consumption Current ( $I_{BAT2}$ ) Characteristics

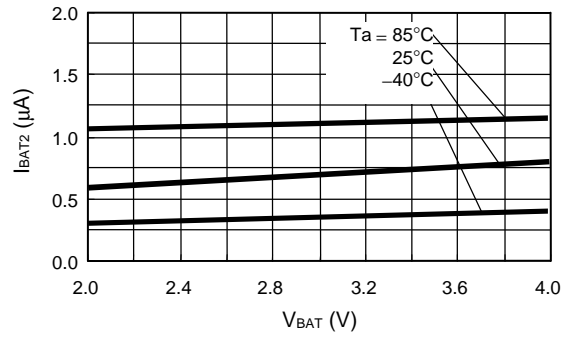

4.3 Consumption Current Temperature Characteristics

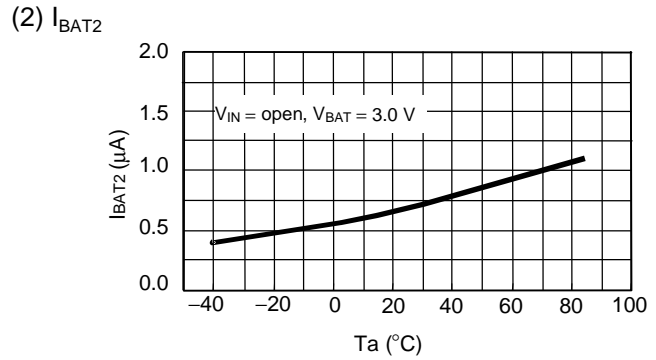
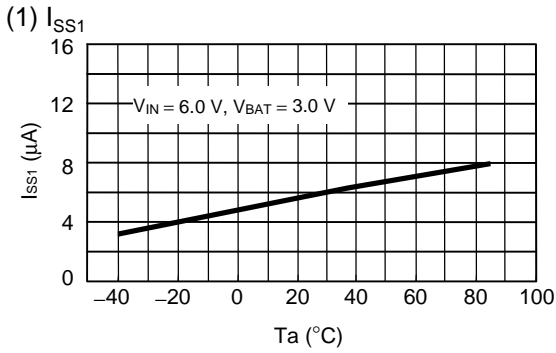



No. FT008-A-P-SD-1.1

TITLE	TSSOP8-E-PKG Dimensions
No.	FT008-A-P-SD-1.1
SCALE	
UNIT	mm
Seiko Instruments Inc.	



No. FT008-E-C-SD-1.0

TITLE	TSSOP8-E-Carrier Tape
No.	FT008-E-C-SD-1.0
SCALE	
UNIT	mm
Seiko Instruments Inc.	





Enlarged drawing in the central part

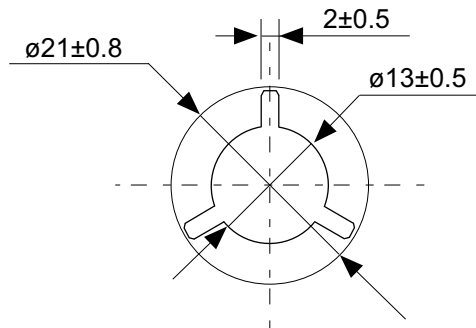

No. FT008-E-R-SD-1.0

TITLE	TSSOP8-E-Reel		
No.	FT008-E-R-SD-1.0		
SCALE		QTY.	3,000
UNIT	mm		
Seiko Instruments Inc.			



Enlarged drawing in the central part



No. FT008-E-R-S1-1.0

TITLE	TSSOP8-E-Reel		
No.	FT008-E-R-S1-1.0		
SCALE		QTY.	4,000
UNIT	mm		
Seiko Instruments Inc.			

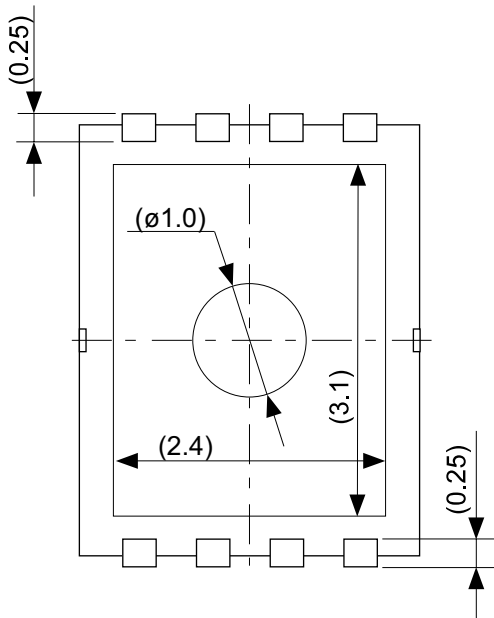
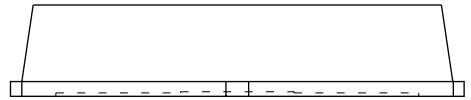
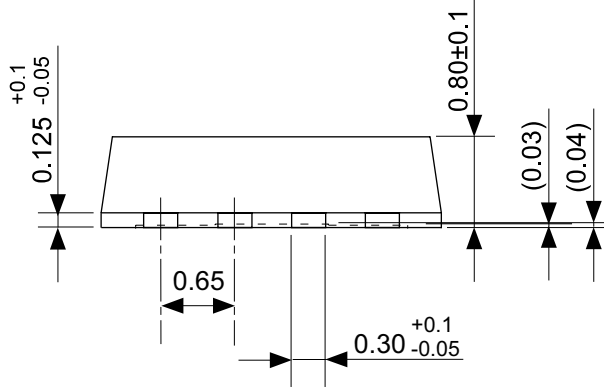
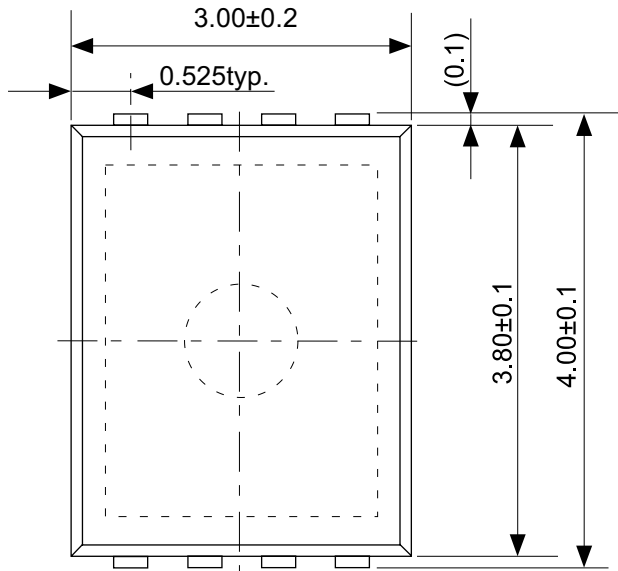

No. PA008-B-P-SD-3.0

TITLE	SON8B-B-PKG Dimensions
No.	PA008-B-P-SD-3.0
SCALE	
UNIT	mm
Seiko Instruments Inc.	

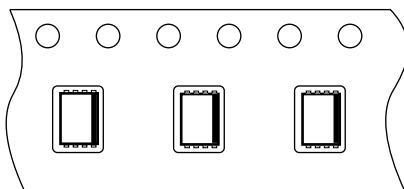
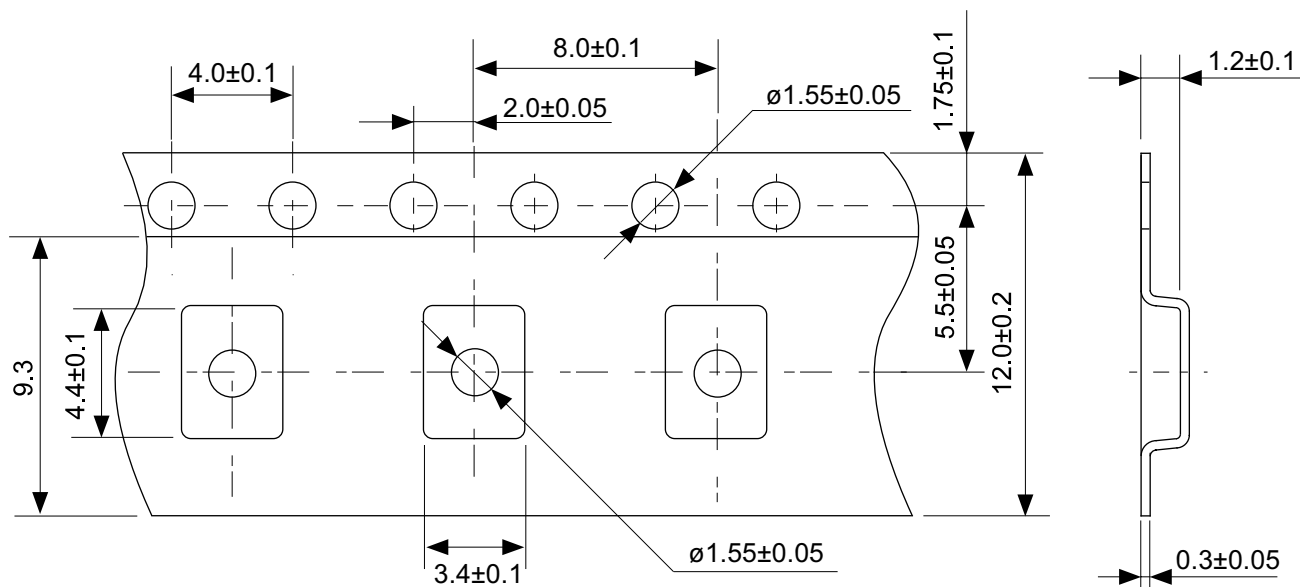

Feed direction

No. PA008-B-C-SD-1.1

TITLE	SON8B-B-Carrier Tape
No.	PA008-B-C-SD-1.1
SCALE	
UNIT	mm
Seiko Instruments Inc.	

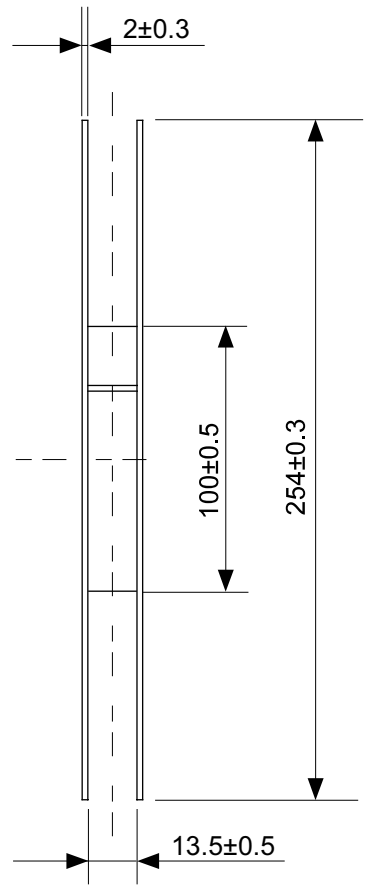
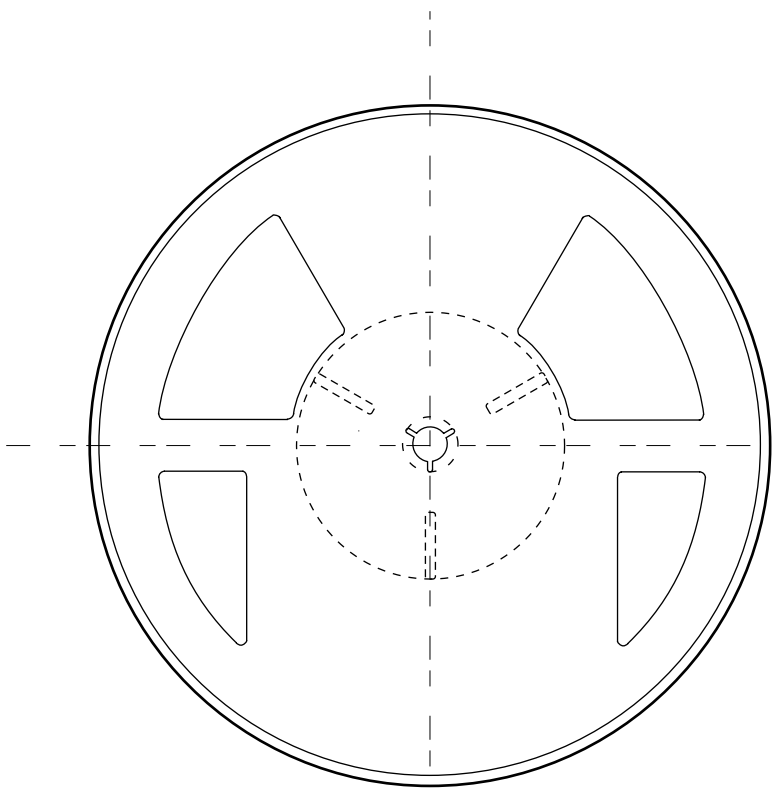

Enlarged drawing in the central part

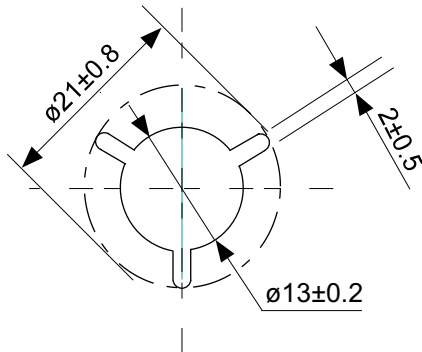

No. PA008-B-R-SD-1.1

TITLE	SON8B-B-Reel		
No.	PA008-B-R-SD-1.1		
SCALE		QTY.	3,000
UNIT	mm		
Seiko Instruments Inc.			



Seiko Instruments Inc.  
[www.sii-ic.com](http://www.sii-ic.com)

- The information described herein is subject to change without notice.
- Seiko Instruments Inc. is not responsible for any problems caused by circuits or diagrams described herein whose related industrial properties, patents, or other rights belong to third parties. The application circuit examples explain typical applications of the products, and do not guarantee the success of any specific mass-production design.
- When the products described herein are regulated products subject to the Wassenaar Arrangement or other agreements, they may not be exported without authorization from the appropriate governmental authority.
- Use of the information described herein for other purposes and/or reproduction or copying without the express permission of Seiko Instruments Inc. is strictly prohibited.
- The products described herein cannot be used as part of any device or equipment affecting the human body, such as exercise equipment, medical equipment, security systems, gas equipment, or any apparatus installed in airplanes and other vehicles, without prior written permission of Seiko Instruments Inc.
- The products described herein are not designed to be radiation-proof.
- Although Seiko Instruments Inc. exerts the greatest possible effort to ensure high quality and reliability, the failure or malfunction of semiconductor products may occur. The user of these products should therefore give thorough consideration to safety design, including redundancy, fire-prevention measures, and malfunction prevention, to prevent any accidents, fires, or community damage that may ensue.