

3M Industrial Products
Abrasives and Power Tools for Welders



Welding Solutions



What's New for 2011

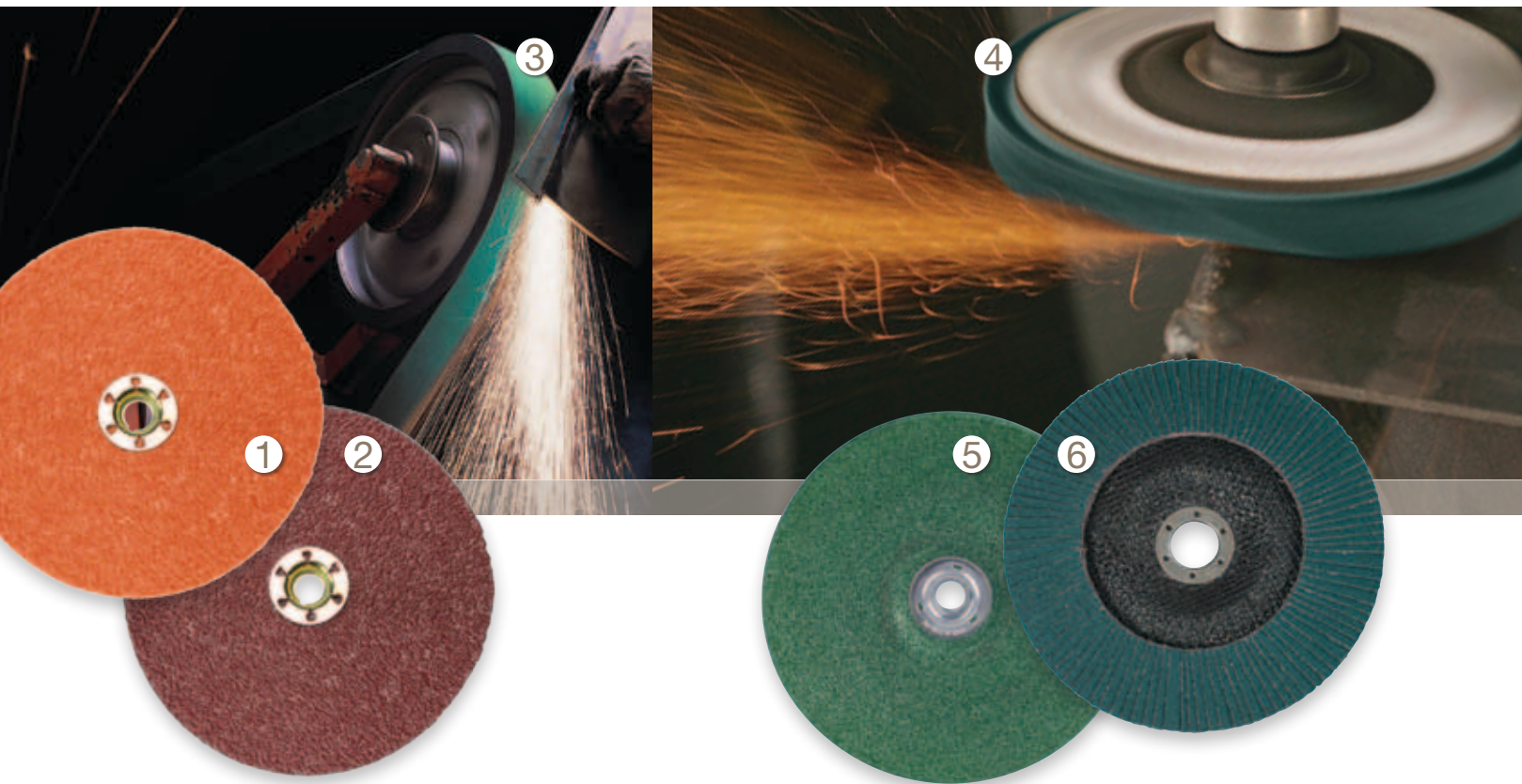

- 1 3M™ Cubitron™ II Fibre Discs 987C** The coolest way to increase productivity. If you work with heat-sensitive metals, like stainless steel, and you value increased throughput and greater operator comfort, try 3M™ Cubitron™ II Fibre Discs 987C. These discs are made with revolutionary 3M precision shaped ceramic grain technology, engineered with ultra-sharp points that dig in and cut fast, run cool and last up to 3 times longer than conventional ceramic discs!
- 2 3M™ Cubitron™ II Fibre Discs 982C** are made with revolutionary 3M precision-shaped ceramic grain technology, engineered with ultra-sharp, fast-cutting points that wear evenly, run cool and optimize mineral breakdown to maximize disc life. 982C out performs comparable fibre discs on life, cut and cost per grind, guaranteed. Finish more parts with fewer discs regardless of grinding pressure.
- 3 3M™ AZ Belt 577F** Because new 3M™ AZ Belts 577F last up to 20% longer than competitive belts, you can grind more parts for about the same price you're now paying for abrasives. Its new and improved premium mineral resin system, tough durable backing, and waterproof grinding aid offers a big bang for your buck. Their outstanding balance of high performance and affordability make 3M AZ Belts 577F an ideal alternative for many day-to-day grinding operations.
- 4 3M™ Flap Disc 546D** is a versatile product that delivers a fast cut, long life, and a smooth finish. Performance and price make these discs a great value and the flap design allows one disc to perform both the grinding and blending steps. Plus, the economic alumina zirconia mineral is ideal for lowering abrasive costs on both mild and stainless steel applications.
- 5 3M™ Green Corps™ Type 28 Depressed Center Wheel** is constructed of 3M™ Ceramic abrasive grain to provide fast cut, long life and high stock removal. Its dish shape is perfect for grinding at lower angles of 15° to 25° and is great for hard to reach areas.
- 6 3M™ Flap Disc 577F** When finish is important, and you value the extra cutting power of alumina zirconia over aluminum oxide, and the versatility to work on all types of metals, choose 3M™ Flap Disc 577F. This durable polyester-backed product provides longer life in high pressure applications, and allows you to combine grinding and blending in one step. Tough enough to tackle sharp edge work and beveling. For those *really big* jobs, try the 3M™ Giant Flap Disc 577F with 25% more thickness for aggressive cut and durability.



Power Tools

Power Tools 2-7



Coated Abrasives

Fibre Discs 8-11
 Flap Discs 12-14
 Stikit™ and PSA Discs 15-16
 Roloc™ Discs 17-20
 Belts 21-24
 Sheets and Rolls 25-27
 Flap Wheels 28-29
 Specialty 30-32



Surface Conditioning Abrasives

Scotch-Brite™ Discs 33-36
 Roloc™ 33-34
 Hook-and-Loop 35
 TN Quick Change 36
 Spindle Mount 36
 Scotch-Brite™ Belts 37
 Scotch-Brite™ Wheels 38-40
 Scotch-Brite™ Specialty Abrasives 41-42
 Scotch-Brite™ Hand Pads 43
 Scotch-Brite™ Rolls 44



Bonded Abrasives

Bonded Wheels 45-46
 Cut-Off Wheels 46



Kits and Packs

Abrasive Kits/Packs 47



Accessories

Abrasive Accessories 48-55

12		
	P12	
	P16	

Abrasive Grade Guides

Abrasive Grade Comparison Guide 56
 Scotch-Brite™ Disc Grade Guide 56

3M™ Power Tools

A full family of innovative tools
to optimize
your abrasive performance
& maximize your comfort



3M™ Die Grinders

Heavy-Duty Grinding

Powerful 1 HP Die Grinders are excellent for big jobs such as weld or stock removal.

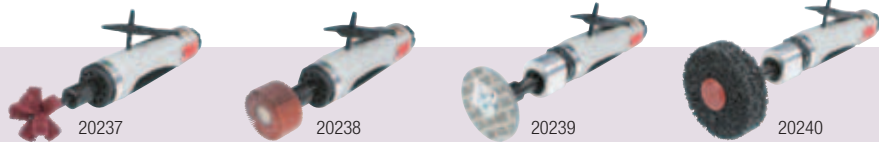

Medium-Duty Grinding

These .5 HP Die Grinders are ideal for medium-duty applications. Available in extended shaft models.



Model No.	Max RPM	Weight Pound (kg)	Length Inch (mm)	Air Inlet Thread	Collet Size	UPC
1 HP (744 W) Motor Airflow Rate: 35 SCFM (991 LPM)						
20237	20,000	1.69 (.77)	7.75 (196.9)	1/4" NPT	1/4"	051141-20237-2
20238	18,000	1.69 (.77)	7.75 (196.9)	1/4" NPT	1/4"	051141-20238-9
20239	12,000	2.06 (.93)	10 (254)	1/4" NPT	1/4"	051141-20239-6
20240	8,000	2.06 (.93)	10 (254)	1/4" NPT	1/4"	051141-20240-2
.5 HP (372 W) Motor Airflow Rate: 35 SCFM (991 LPM)						
NEW! 28330	18,000	1.13 (.512)	6.88 (174.6)	1/4" NPT	1/4"	051141-28330-2
NEW! 28331	18,000*	1.54 (.697)	10.63 (269.9)	1/4" NPT	1/4"	051141-28331-9
NEW! 28332	4,000	1.58 (.717)	8.88 (200)	1/4" NPT	1/4"	051141-28332-6

*with extension

- 1 High-output thermally balanced air motor
- 2 Directional exhaust (360 degree)
- 3 3M™ Gripping Material
- 4 Safety lever throttle to avoid accidental starting
- 5 Tandem double-sealed bearings
- 6 Double-taper collet assembly
- 7 Offset gear box for increased torque

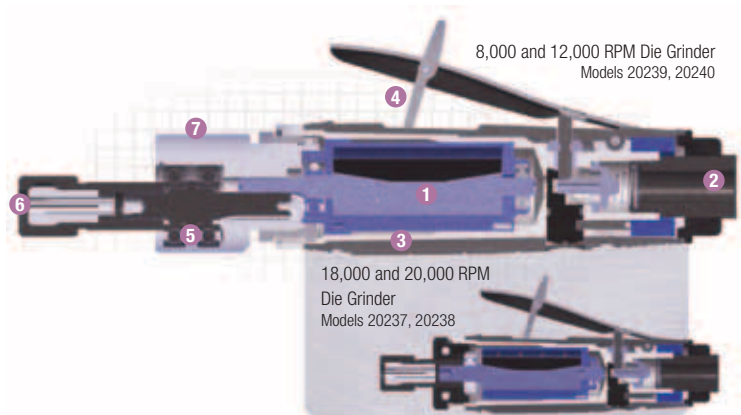

3M™ Grinder and Extended Grinder

Packed with power without excessive weight for more comfortable grinding and improved productivity. With a maximum run speed of 12,000 RPM, high torque, 1 HP motor and hardened steel rotor, these air-tools are built for durability and smooth operation. The new 3M™ Grinders are the perfect complement for use with 3M Abrasive Discs with 4" or 4.5" diameters. 3M Grinders feature repositionable guards for better visibility, steel gear heads for added durability and superior noise reduction. Get more power and productivity from 3M™ Power Tools.



	Model No.	Weight Pound (kg)	Length	Height Inch (mm)	Air Inlet	Thread	UPC
	Tool Diameter: 4" Max RPM: 12,000 Motor: 1 HP (744 W)						
NEW!	28403	2.66 (1.21)	Standard	4.5 (114)	3/8" NPT*	3/8-24 EXT	051141-28403-3
NEW!	28413	3.85 (1.75)	Extended	4.5 (114)	3/8" NPT*	3/8-24 EXT	051141-28413-2
	Tool Diameter: 4-1/2" Max RPM: 12,000 Motor: 1 HP (744 W)						
NEW!	28405	2.84 (1.29)	Standard	4.7 (119)	3/8" NPT*	5/8-11 EXT	051141-28405-7
NEW!	28414	4.03 (1.83)	Extended	4.7 (119)	3/8" NPT*	5/8-11 EXT	051141-28414-9

*includes 3/8" to 1/4" reducer

3M™ Cut-Off Wheel Tools

Designed to easily handle cutting through everything from standard rebar to oversized bolts, you can count on the performance and dependability of the new line of 3M™ Cut-Off Wheel Tools.



NEW! 3M™ Cut-Off Wheel Tool Extended

New 18,000 RPM, 1 HP tool with right angle head and repositionable guard for optimal power and visibility. Extended body style for greater versatility and control. Features 3M™ Gripping Material for added comfort.

	Model No.	Tool Dia. Inch (mm)	Max RPM	Weight Pound (kg)	Length Inch (mm)	Height Inch (mm)	Air Inlet Thread	UPC
	Motor: 1 HP (744 W) Airflow Rate: 35 SCFM (991 LPM)							
	20233	3 (76)	25,000	2.09 (.95)	7.75 (196.9)	3 (76.2)	1/4" NPT	051141-20233-4
	20234	4 (100)	20,000	2.25 (1.02)	7.75 (196.9)	3.25 (82.6)	3/8" NPT	051141-20234-1
	20235	5 (125)	12,000	3.47 (1.57)	8.75 (222.3)	5.25 (133.4)	3/8" NPT	051141-20235-8
	20236	6 (152)	10,000	3.69 (1.67)	8.75 (222.3)	5.25 (133.4)	3/8" NPT	051141-20236-5
NEW!	28407*	4 (100)	18,000	2.77 (1.26)	8.5 (216)	4.7 (119)	3/8" NPT*	051141-28407-1

*includes 3/8" to 1/4" reducer

- 1 High-output air motor
- 2 Directional exhaust (360 degree) — not on Model No. 28407
- 3 3M™ Gripping Material
- 4 Safety lever throttle to avoid accidental starting
- 5 Over-sized ball bearings on output spindle
- 6 Robust spiral bevel gearing
- 7 4-place indexable head
- 8 360° rotatable safety guard

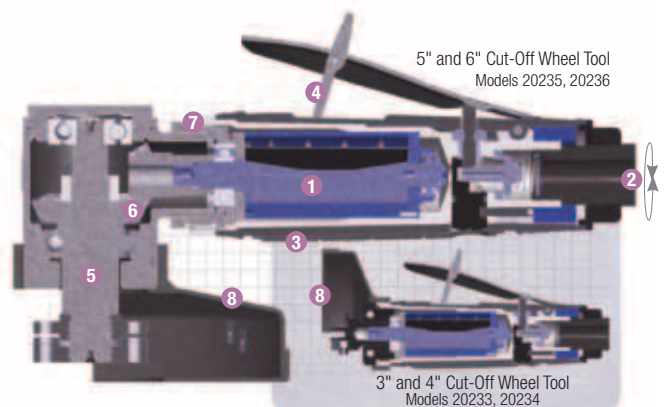

5" and 6" Cut-Off Wheel Tool Models 20235, 20236

3" and 4" Cut-Off Wheel Tool Models 20233, 20234

3M™ Elite Non-Vacuum Random Orbital Sanders

We took our best line of air-powered 3M™ Random Orbital Sanders and just made it better. Features exclusive 3M™ Gripping Material and extended, curved wrist rest for more support. Recessed lever eliminates pinch points. Internal muffler decreases noise by as much as 4 dB. Aluminum body covered with a durable composite cover helps prevent cracked housings. Improved dust collection port.



Model No.	Orbit Dia. Inch (mm)	Weight Pound (kg)	Length Inch (mm)	Height Inch (mm)	Pad Included	UPC
Tool Diameter: 3" (77mm) Max RPM: 12,000 Motor: .28 HP (209 W) Airflow Rate: 17 SCFM (481 LPM)						
NEW! 28496	3/32 (2.5)	1.31 (.596)	5.78 (147)	3.38 (86)	Stikit™ 20348	051141-28496-5
NEW! 28494	3/16 (5)	1.52 (.692)	5.78 (147)	3.64 (92.5)	Stikit™ 20348	051141-28494-1
Tool Diameter: 5" (127mm) Max RPM: 12,000 Motor: .28 HP (209 W) Airflow Rate: 17 SCFM (481 LPM)						
NEW! 28498	3/32 (2.5)	1.72 (.781)	6.77 (172)	3.58 (91)	Stikit™ 20351	051141-28498-9
NEW! 28497	3/16 (5)	1.76 (.8)	6.77 (172)	3.58 (91)	Stikit™ 20351	051141-28497-2
NEW! 28495	5/16 (8)	1.8 (.817)	6.77 (172)	3.58 (91)	Stikit™ 20351	051141-28495-8
Tool Diameter: 6" (150mm) Max RPM: 12,000 Motor: .28 HP (209 W) Airflow Rate: 17 SCFM (481 LPM)						
NEW! 28501	3/32 (2.5)	2.1 (.957)	7.36 (187)	3.58 (91)	Stikit™ 20354	051141-28501-6
NEW! 28500	3/16 (5)	1.86 (.844)	7.36 (187)	3.58 (91)	Stikit™ 20354	051141-28500-9
NEW! 28499	5/16 (8)	1.91 (.869)	7.36 (187)	3.58 (91)	Stikit™ 20354	051141-28499-6

- 1 3M™ Gripping Material helps absorb and reduce vibration
- 2 Aluminum body covered with a durable composite cover helps prevent cracked housings
- 3 Extended and curved wrist rest for more support
- 4 Recessed lever, no pinch points
- 5 Internal muffler decreases noise up to 4 dB and won't easily break off

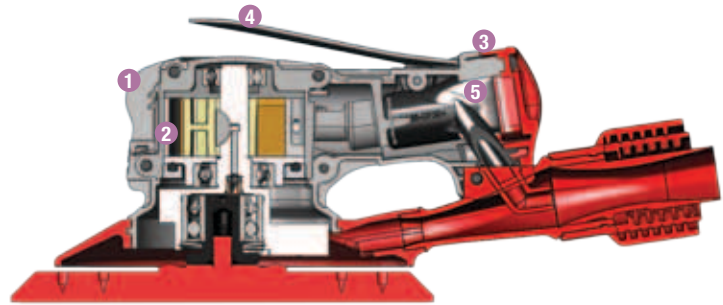

3M™ Non-Vacuum Random Orbital Sanders

These powerful and popular non-vacuum tools meet or exceed highest performance standards and are precision balanced for smooth operation. A variety of grip sizes are available and lever is color-coded for orbit identification. For use on wood, composites, solid surface or metalworking applications.



Model No.	Orbit Dia. Inch (mm)	Weight Pound (kg)	Length Inch (mm)	Height Inch (mm)	Pad Included	UPC
Tool Diameter: 3" (77mm) Max RPM: 12,000 Motor: .28 HP (209 W) Airflow Rate: 17 SCFM (481 LPM)						
20314	3/32 (2.5)	1.12 (.51)	4.90 (124.33)	3.10 (78.61)	Stikit™ 20348	051141-20314-0
20250	3/16 (5)	1.65 (.75)	4.90 (124.33)	3.10 (78.61)	Hookit™ 20350	051141-20250-1
Tool Diameter: 5" (127mm) Max RPM: 12,000 Motor: .28 HP (209 W) Airflow Rate: 17 SCFM (481 LPM)						
20320	3/32 (2.5)	1.59 (.72)	5.84 (148.4)	3.26 (82.9)	Stikit™ 20351	051141-20320-1
20317	3/16 (5)	1.65 (.75)	5.89 (149.6)	3.26 (82.9)	Stikit™ 20351	051141-20317-1
20253	5/16 (8)	1.65 (.75)	5.89 (149.6)	3.26 (82.9)	Stikit™ 20351	051141-20253-2
Tool Diameter: 6" (150mm) Max RPM: 12,000 Motor: .28 HP (209 W) Airflow Rate: 17 SCFM (481 LPM)						
20328	3/32 (2.5)	1.68 (.76)	6.34 (161.1)	3.26 (82.9)	Stikit™ 20354	051141-20328-7
20325	3/16 (5)	1.74 (.79)	6.39 (162.3)	3.26 (82.9)	Stikit™ 20354	051141-20325-6
20324	5/16 (8)	1.78 (.81)	6.39 (162.3)	3.26 (82.9)	Stikit™ 20354	051141-20324-9

3M™ Inline Sanders 1 HP (744W)

Generate straight line scratches for finishing stainless steel and other metals. These straight shaft sanders can be used with inflatable or slotted wheel accessories and many other wheel products.



Model No.	Max RPM	Weight Pound (kg)	Length Inch (mm)	Air Inlet Thread	Collet Size	UPC
Motor: 1 HP (744 W)						
28338	1,600	3.32 (1.51)	9.88 (251)	1/4" NPT	5/8"-11	051141-28338-8
28339	3,500	2.64 (1.20)	8.50 (216)	1/4" NPT	5/8"-11	051141-28339-5



3M™ Disc Sanders

Designed for comfort and power, the 3M pneumatic disc sanders feature: 3M™ Gripping Material for a secure grip with less effort; a 97° head for decreased wrist strain; easy-handling, compact design for less vibration; 3M™ Roloc™ Disc Pads can directly mount to sander without collet.



3M™ Disc Sander

3M's new Disc Sander 28408 delivers versatility, durability and power (1 HP). Combined with 3M™ and Scotch-Brite™ Abrasive Discs and Disc Accessories, the new sander expands 3M's right angle grinding systems to include 4", 4-1/2" and 5" discs for a variety of metalworking applications. The new tool design includes hardened steel rotors for superior motor function and smoothness, a precision valve system for accurate speed control, steel gear head casings for added durability and vibration and noise reduction features.

Model No.	Motor	Weight Pound (kg)	Length Inch (mm)	Height Inch (mm)	Airflow Rate SCFM (LPM)	Exhaust Direction	UPC Code
Tool Diameter: 2" (50mm) Max RPM: 12,000 Air Inlet Thread: 1/4" NPT							
28328	.3 HP (223 W)	1.09 (.49)	5.91 (150.2)	2.5 (63.5)	17 (481)	Rear Directional	051141-28328-9
28329	.5 HP (372 W)	1.28 (.58)	6.75 (171.5)	2.75 (69.9)	23 (651)	Rear Directional	051141-28329-6
Tool Diameter: 2" (50mm) Max RPM: 20,000 Air Inlet Thread: 1/4" NPT							
28341	.3 HP (223 W)	1.09 (.49)	5.91 (150.2)	2.5 (63.5)	17 (481)	Rear Directional	051141-28341-8
20231	.5 HP (372 W)	1.28 (.58)	6.75 (171.5)	2.75 (69.9)	23 (651)	Rear Directional	051141-20231-0
Tool Diameter: 3" (76mm) Max RPM: 15,000 Air Inlet Thread: 1/4" NPT							
20232	1 HP (744 W)	1.97 (.89)	8.25 (209.6)	3.25 (82.6)	35 (991)	Rear Directional	051141-20232-7
Tool Diameter: 4"-5" (100-125mm) Max RPM: 12,000 Air Inlet Thread: 3/8" NPT*							
NEW! 28408	1 HP (744 W)	3.1 (1.4)	12.5 (317.5)	4.23 (107.4)	35 (991)	Rear	051141-28408-8

*includes 3/8" to 1/4" reducer

- 1 High-output air motor
- 2 Directional exhaust (360 degree*) — not on Model No. 28408
- 3 3M™ Gripping Material
- 4 Safety lever throttle to avoid accidental starting
- 5 Needle and ball bearing supported output spindle
- 6 Robust spiral bevel gearing
- 7 97° head (vs. 90°) allows for more comfortable wrist position
- 8 Direct mount for use with 3M™ Roloc™ Backup Pads without using a collet
- 9 Shorter distance to the workpiece generates less vibration and allows for better control

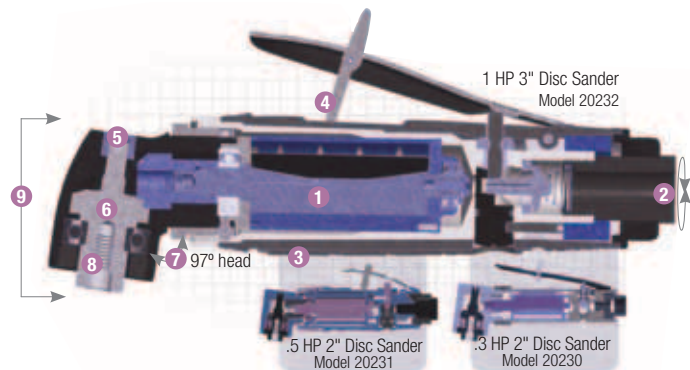

3M™ File Belt Sander

Ideally suited for use with 3M™ Abrasive Belts and Scotch-Brite™ Belts for a variety of metalworking applications. Grind and blend from contact wheel or platen, finish and polish from slack of belt.



Model No.	Motor	Motor Speed RPM	Belt Speed SFPM (SMM)	Weight Pound (kg)	Length Inch (mm)	Height Inch (mm)	Width Inch (mm)	UPC
28366	0.6 HP	22,000	4990 (1521)	2.8 (1.3)	14.57 (370)	2.93 (74.5)	5.95 (151.2)	051141-28366-1

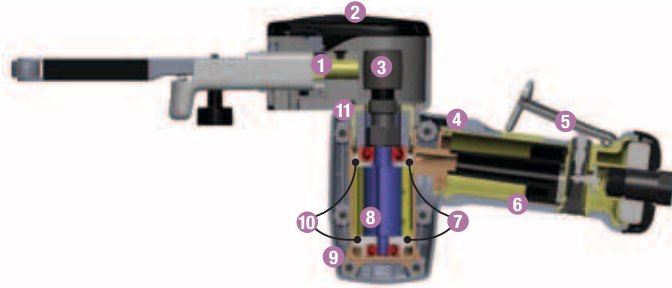

- 1 Hardened Steel Arm Post – provides stability
- 2 Metal Shielded Composite Belt Cover
- 3 Easily Interchangeable Steel or Rubber Drive Pulley
- 4 360° Rotatable Handle
- 5 Smooth Action Safety Lever – helps prevent accidental starting
- 6 Comfortable 3M™ Gripping Material
- 7 Steel Endplates – provide stability for more power; longer motor life
- 8 Hardened Steel Rotor – delivers more torque; provides wear resistance
- 9 Lightweight Reinforced Composite Housing
- 10 Contamination Resistant Double Shielded Precision Bearings
- 11 60° Rotatable Belt Housing/Guard

3M™ File Belt Sander Kit

This convenient kit comes packed in a molded case and includes:

- 3M™ File Belt Sander (PN 28366)
- 2 popular attachment arms (PNs 28368 and 28370)
- 0.5 oz. sample of 3M™ Air Tool Lubricant (PN20451)
- Steel and rubber drive wheels

Model No.	UPC
28367	051141-28367-8





95298

3M™ Fibre Discs

Choose the performance level that fits your needs with a complete offering of 3M™ Fibre Discs. Get great performance at a great price with 3M's general purpose metalworking disc 381C. Or, set a new standard for productivity with 3M™ Cubitron™ II 982C Discs. All of 3M's fibre discs are available in a variety of sizes.

3M™ Fibre Disc Selection Guide

Select Fibre Discs for fast cutting when grinding and blending.

	Product ID	Mineral	Metal Type
Good	381C	Aluminum Oxide	Carbon Steel
	501C	Alumina Zirconia	Stainless/Aluminum
Better	501C	Alumina Zirconia	Carbon Steel
	785C	Ceramic Aluminum Oxide Blend	Stainless/Aluminum
Best	988C	Ceramic Abrasive Grain	Carbon Steel
	985C	Ceramic Abrasive Grain	Stainless/Aluminum
Premium	982C	Precision Shaped Ceramic	Carbon Steel
	987C	Precision Shaped Ceramic	Stainless/Aluminum

3M™ Fibre Discs 381C

- General purpose disc for weld removal, grinding and blending
- Resin bond aluminum oxide provides durability and aggressive stock removal



159094

UPC	Grade	Max. RPM	Dia. x Ctr. Hole	Min./Case
051144-77595-8	24	13,300	4-1/2" x 7/8"	
051144-77596-5	36			
051144-77597-2	50			
051144-77598-9	60			
051144-77599-6	80			
051144-77600-9	100			
051144-77601-6	120	12,000	5" x 7/8"	25
051144-81369-8	24			
051144-81372-8	36			
051144-81375-9	50			
051144-01727-0	60			
051144-20054-2	80			
051144-20053-5	100	8,600	7" x 7/8"	
051144-20052-8	120			
051144-01745-4	16			
051144-81370-4	24			
051144-81373-5	36			
051144-81376-6	50			
051144-01741-6	60	6,600	9-1/8" x 7/8"	25/100
051144-01740-9	80			
051144-01739-3	100			
051144-01738-6	120			25
051144-81371-1	24			
051144-81373-5	36			
051144-81377-3	50			
051144-01762-1	80	100		
051144-01761-4†	100			
051144-01760-7†	120			

† Made-to-Order

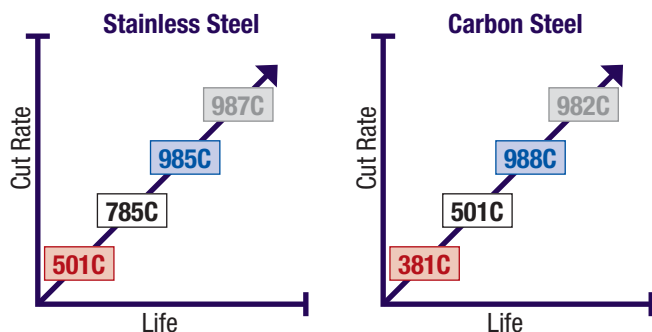

See pages 48–55 for available accessories.

3M™ Fibre Discs (cont.)

3M™ Fibre Discs 501C

- Versatile disc for use on a wide variety of metals
- Aluminum zirconia provides a good option for both stainless and mild steel applications



51773

UPC	Grade	Max. RPM	Dia. x Ctr. Hole	Min./Case
051111-50409-3	24	13,300	4-1/2" x 7/8"	25/100
051111-50413-0	36			
051111-50414-7	50			
051111-50415-4	60			
051111-50416-1	80			
051111-50417-8	100			
051111-50419-2	120			
051111-50410-9	24	12,000	5" x 7/8"	
051111-50412-3	36			
051111-50420-8	50			
051111-50421-5	60			
051111-50422-2	80			
051111-50423-9	100			
051111-50424-6	120			
051111-50411-6	24	8,600	7" x 7/8"	
051111-50426-0	36			
051111-50425-3	50			
051111-50427-7	60			
051111-50428-4	80			
051125-63799-2†	100			
051111-50430-7†	120			
051111-50432-1†	24	6,600	9-1/8" x 7/8"	
051111-50433-8	36			
051111-50434-5†	50			

† Made-to-Order

3M™ Fibre Discs 785C

- 3M™ Ceramic Aluminum Oxide blend abrasive grain
- An excellent starting point for stainless steel
- Includes a grinding aid for cooler running



60875

UPC	Grade	Max. RPM	Dia. x Ctr. Hole	Min./Case
051111-60719-0	36	13,300	4-1/2" x 5/8-11*	25
051144-80660-7	36	13,300	4-1/2" x 7/8"	25/100
051144-80661-4	50			
051144-80662-1	60			
051144-80663-8	80			
051144-80665-2	P120			
051144-13931-6	24			
051144-13930-9	36			
051144-13928-6	50			
051144-13977-4	60			
051144-13926-2	80			
051144-80654-6	P100			
051144-80655-3	P120			
051144-88831-3†	60	8,600	7" x 5/8-11*	
051144-13937-8	24		7" x 7/8"	
051144-13936-1	36			
051144-13934-7	50			
051144-13933-0	60			
051144-13932-3	80			
051144-80656-0	P100			
051144-80657-7	P120			
051144-13943-9	24	6,600	9-1/8" x 7/8"	
051144-13942-2	36			
051144-13940-8	50			
051144-13938-5	80			

† Made-to-Order

* Quick Change Tinneman Nut Attachment

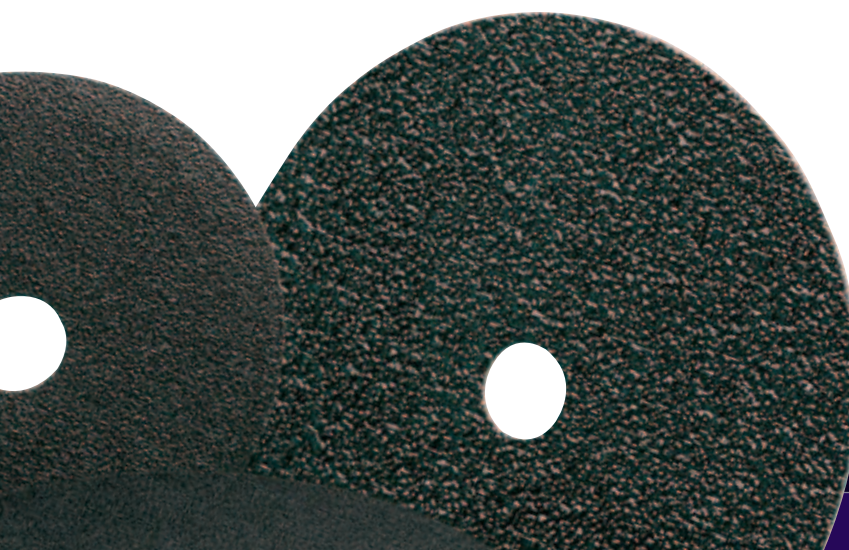

Tech Tip

Weld Blending Mild Steel for Paint Prep

Step 1 – Fibre Disc 982C Grade 36+

Step 2 – Scotch-Brite™ Light Grinding and Blending Disc SD on black ribbed pad

Step 3 – Apply 3 mil Paint

Results – Productivity increase
– Abrasive cost improvement

See pages 48–55 for available accessories.

3M™ Fibre Discs (cont.)

NEW! 3M™ Cubitron™ II Fibre Disc 982C

- 3M precision-shaped ceramic grain, engineered with ultra-sharp, fast cutting points that wear evenly, run cool, and optimize mineral breakdown to maximize life
- Best in class for weld prep and removal on carbon steel applications

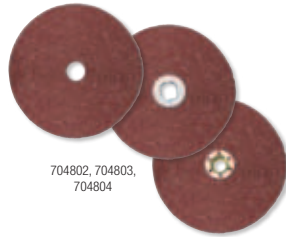

704802, 704803, 704804



606708

UPC	Grade	Max. RPM	Dia. x Ctr. Hole	Min./Case
051141-27400-3	36+	13,300	4-1/2" x 7/8"	25/100
051141-27631-1	60+			
051141-27635-9	80+			
051141-27401-0	36+	12,000	5" x 7/8"	
051141-27632-8	60+			
051141-27636-6	80+			
051141-27402-7	36+	8,600	7" x 7/8"	
051141-27633-5	60+			
051141-27637-3	80+			
051141-27403-4	36+	6,600	9-1/8" x 7/8"	
051141-27634-2	60+			
051141-27638-0	80+			
TN Quick Change				
051141-27425-6	36+	13,300	4-1/2" x 5/8-11*	25/100
051141-27639-7	60+			
051141-27642-7	80+			
051141-27404-1	36+	12,000	5" x 5/8-11*	
051141-27640-3	60+			
051141-27643-4	80+			
051141-27405-8	36+	8,600	7" x 5/8-11*	
051141-27641-0	60+			
051141-27644-1	80+			
GL Quick Change				
051141-27406-5	36+	12,000	5" x 5/8-11*	25/100
051141-27724-0	60+			
051141-27726-4	80+			
051141-27407-2	36+	8,600	7" x 5/8-11*	
051141-27725-7	60+			
051141-27727-1	80+			

* Quick Change Tinneman Nut Attachment

3M™ Fibre Discs 985C

- 3M™ Ceramic abrasive grain
- 3M's better choice for a long-lasting disc for stainless steel
- Includes a grinding aid for cooler running



157186

UPC	Grade	Max. RPM	Dia. x Ctr. Hole	Min./Case
051111-55767-9	36	12,000	5" x 7/8"	25/100
051111-55780-8	50			
051111-55776-1	60			
051111-55779-2	80	8,600	7" x 7/8"	
051111-55971-0	24			
051111-55972-7	36			
051111-55973-4	50	8,600	7" x 7/8"	
051111-55974-1	60			
051111-55975-8	80			

Tech Tip

Use 3M™ Red Ribbed Pads to optimize product life of 900 series fibre discs—grades 24 and 36.

See pages 48–55 for available accessories.

3M™ Fibre Discs (cont.)

NEW! 3M™ Cubitron™ II Fibre Disc 987C

- 3M precision-shaped ceramic grain, engineered with ultra-sharp, fast cutting points that wear evenly, run cool, and optimize mineral breakdown to maximize life
- Best in class for weld prep and removal on heat sensitive alloys such as stainless steel



3M™ Fibre Discs 988C

- 3M™ Ceramic abrasive grain
- 3M's best premium disc for long-lasting performance for mild steel grinding



UPC	Grade	Max. RPM	Dia. x Ctr. Hole	Min./Case	
051141-27447-8	36+	13,300	4-1/2" x 7/8"	25/100	
051141-27653-3	60+				
051141-27657-1	80+				
051141-27448-5	36+	12,000	5" x 7/8"		
051141-27654-0	60+				
051141-27658-8	80+				
051141-27449-2	36+	8,600	7" x 7/8"		
051141-27655-7	60+				
051141-27659-5	80+				
051141-27450-8	36+	6,600	9-1/8" x 7/8"		
051141-27656-4	60+				
051141-27660-1	80+				
TN Quick Change					
051141-27469-0	36+	13,300	4-1/2"	25/100	
051141-27661-8	60+				
051141-27664-9	80+				
051141-27467-6	36+	12,000	5"		
051141-27662-5	60+				
051141-27665-6	80+				
051141-27468-3	36+	8,600	7"		
051141-27663-2	60+				
051141-27666-3	80+				
GL Quick Change					
051141-27728-8	36+	12,000	5"		25/100
051141-27730-1	60+				
051141-27732-5	80+				
051141-27729-5	36+	8,600	7"		
051141-27731-8	60+				
051141-27733-2	80+				

UPC	Grade	Max. RPM	Dia. x Ctr. Hole	Min./Case
051111-55712-9	36	13,300	4-1/2" x 5/8-11*	25/100
051141-27341-9†	36	12,000	5" x 5/8-11*	100
051111-55746-4	24	12,000	5" x 7/8"	25/100
051111-55743-3	36			
051111-55742-6	50			
051111-60319-2	60			
051111-55740-2	80			
051111-55840-9	24	8,600	7" x 5/8-11*	
051111-55715-0	36			
051111-55964-2	24			
051111-55965-9	36			
051111-55966-6	40			
051111-55967-3	50			
051111-55739-6	60			
051111-55968-0	80			
051111-60314-7	24	6,600	9-1/8" x 7/8"	50/100
051111-55744-0	24			
051111-55735-8	36			
051111-55733-4	50			25/100

† Made-to-Order
 * Quick Change Tinneman Nut Attachment

See pages 48–55 for available accessories.

3M™ Flap Discs

3M™ Flap Discs offer an unbeatable system for grinding and blending in one easy step. The construction wears away, exposing fresh mineral to extend disc life and provide consistent cut rates. Great for weld grinding, blending, deburring, rust removal, surface prep and edge grinding on all types of metal. Available in both T29 or T27 constructions with or without the 5/8–11 hub.

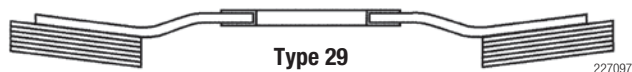

3M™ Flap Disc Selection Guide

Select Flap Discs for extended life and single-step grinding/blending on all types of metals.

	Product ID	Mineral	4-1/2" x 7/8"		4-1/2" x 5/8-11		7" x 7/8"		7" x 5/8-11	
			T27	T29	T27	T29	T27	T29	T27	T29
Good	546D	Alumina Zirconia	●	●	●	●	●	●	●	●
	577F	Alumina Zirconia	●	●	●	●	●	●	●	●
Better	747D	Ceramic Aluminum Oxide Blend	●		●		●			

NEW! 3M™ Flap Discs 546D

- Versatile alumina zirconia mineral works on a variety of metals and applications
- Flexible X wt. cotton backing designed for fast cut on light duty grinding/finishing applications

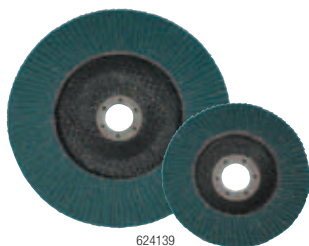

3M™ Flap Discs 546D (cont.)

UPC	Grade	Max. RPM	Dia. x Ctr. Hole	Qty./Case
Type 29				
051115-28874-6†	24	13,300	4-1/2" x 7/8"	10
051115-28875-3†	36			
051115-28876-0	40			
051115-28877-7	60			
051115-28878-4	80			
051115-28879-1†	120			
051115-28868-5†	24		4-1/2" x 5/8-11*	
051115-28869-2†	36			
051115-28870-8	40			
051115-28871-5	60			
051115-28872-2	80			
051115-28873-9†	120			

† Made-to-Order
* Quick Change Hub Attachment

UPC	Grade	Max. RPM	Dia. x Ctr. Hole	Qty./Case
Type 29				
051115-28926-2†	24	8,600	7" x 7/8"	5
051115-28927-9†	36			
051115-28928-6	40			
051115-28929-3	60			
051115-28930-9	80			
051115-28931-6†	120			
051115-28920-0†	24		7" x 5/8-11*	
051115-28921-7†	36			
051115-28922-4	40			
051115-28923-1	60			
051115-28924-8	80			
051115-28925-5†	120			

† Made-to-Order
* Quick Change Hub Attachment

See pages 48–55 for available accessories.

3M™ Flap Discs (cont.)

3M™ Flap Discs 546D (cont.)

UPC	Grade	Max. RPM	Dia. x Ctr. Hole	Qty./Case
Type 27				
051141-30598-1†	36	13,300	4-1/2" x 7/8"	10
051141-30599-8	40			
051141-30600-1	60			
051141-30601-8	80			
051141-30602-5†	120			
051141-30593-6†	36			
051141-30594-3	40			
051141-30595-0	60			
051141-30596-7	80			
051141-30597-4†	120			
051141-30603-2†	36	8,600	7" x 7/8"	5
051141-30604-9	40			
051141-30605-6	60			
051141-30606-3	80			
051115-28917-0†	120			
051141-30607-0†	36			
051141-30608-7	40			
051141-30609-4	60			
051141-30610-0	80			
051115-28919-4†	120			

† Made-to-Order
* Quick Change Hub Attachment

NEW! 3M™ Flap Discs 577F

- Versatile alumina zirconia mineral works on a variety of metals and applications
- Durable YF wt. polyester backing designed for long life on the most heavy duty grinding applications

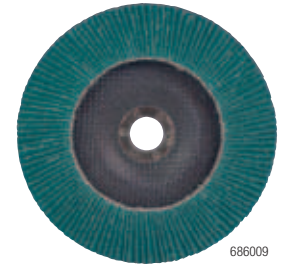

UPC	Grade	Max. RPM	Dia. x Ctr. Hole	Qty./Case
Type 29				
051141-30983-5	36	13,300	4-1/2" x 5/8-11	10
051141-30984-2	40			
051141-30985-9	60			
051141-30986-6	80			
051141-30987-3	36			
051141-30988-0	40			
051141-30989-7	60			
051141-30990-3	80			
051141-30991-0	36			
051141-30992-7	40			
051141-30993-4	60	8,600	7" x 5/8-11	5
051141-30994-1	80			
051141-30995-8	36			
051141-30996-5	40			
051141-30997-2	60			
051141-30998-9	80			

Type 27				
051141-30951-4	36	13,300	4-1/2" x 5/8-11	10
051141-30952-1	40			
051141-30953-8	60			
051141-30954-5	80			
051141-30955-2	36			
051141-30956-9	40			
051141-30957-6	60			
051141-30958-3	80			
051141-30963-7	36			
051141-30964-4	40			
051141-30965-1	60	8,600	7" x 5/8-11	5
051141-30966-8	80			
051141-30959-0	36			
051141-30960-6	40			
051141-30961-3	60			
051141-30962-0	80			

Tech Tip

Flap discs typically provide a finish one grade finer than they are graded.

See pages 48–55 for available accessories.

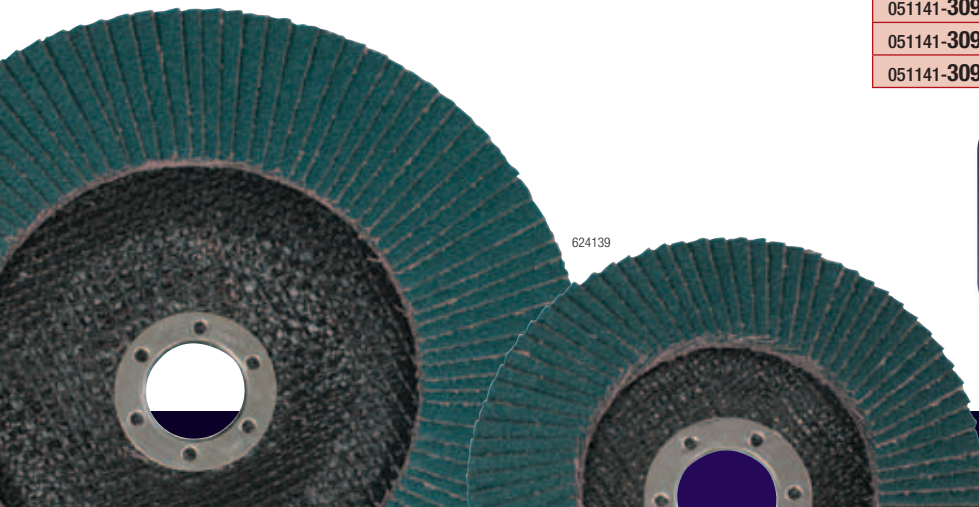

3M™ Flap Discs (cont.)

NEW! 3M™ Giant Flap Discs 577F

- Versatile alumina zirconia mineral works on a variety of metals and applications
- Durable YF wt. polyester backing designed for long life on the most heavy duty grinding applications
- 25% more flaps than standard 3M™ Flap Discs 577F

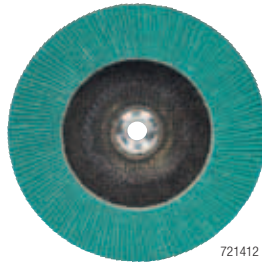

721412

UPC	Grade	Max. RPM	Dia. x Ctr. Hole	Qty./Case			
Type 29							
051141-30999-6	36	13,300	4-1/2" x 5/8-11	10			
051141-31000-8	40						
051141-31001-5	60						
051141-31002-2	80						
051141-31003-9	36						
051141-31004-6	40		4-1/2" x 7/8"				
051141-31005-3	60						
051141-31006-0	80						
051141-31011-4	36				8,600	5	
051141-31012-1	40						7" x 5/8-11
051141-31013-8	60						
051141-31014-5	80						
051141-31007-7	36						
051141-31008-4	40	7" x 7/8"					
051141-31009-1	60						
051141-31010-7	80						
Type 27							
051141-30967-5	36		13,300	4-1/2" x 5/8-11			10
051141-30968-2	40						
051141-30969-9	60						
051141-30970-5	80						
051141-30971-2	36	4-1/2" x 7/8"					
051141-30972-9	40						
051141-30973-6	60						
051141-30974-3	80			8,600	5		
051141-30979-8	36					7" x 5/8-11	
051141-30980-4	40						
051141-30981-1	60						
051141-30982-8	80						
051141-30975-0	36	7" x 7/8"					
051141-30976-7	40						
051141-30977-4	60						
051141-30978-1	80						

3M™ Flap Discs 747D

- 3M™ Ceramic Aluminum Oxide blend abrasive grain provides extended cut and life on hard metals



84696

UPC	Grade	Max. RPM	Dia. x Ctr. Hole	Qty./Case
Type 27				
051111-49613-8	36	13,300	4-1/2" x 7/8"	10
051111-49614-5	50			
051111-49615-2	60			
051111-49616-9	80			
051111-49617-6	P120			
051111-55805-8	36			
051111-61057-2†	50			
051111-61058-9†	60			
051111-61059-6†	80			
051111-61060-2†	P120		8,600	
051111-49608-4	36			
051111-49609-1	50			
051111-49610-7	60			
051111-49611-4	80			
051111-49612-1†	120			

† Made-to-Order

* Quick Change Tinneman Nut Attachment

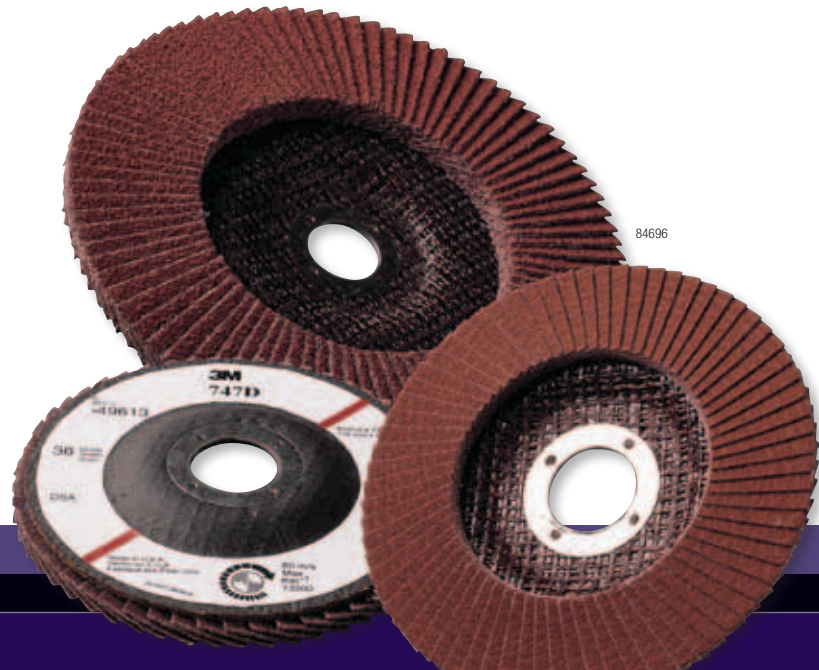

84696

See pages 48-55 for available accessories.

3M™ Stikit™ and PSA Discs

3M™ Stikit™ and PSA Discs are designed to handle a wide range of sanding and finishing needs. These discs have a pressure sensitive adhesive coating on the back side for easy application and clean removal.

3M™ Stikit™ and PSA Disc Selection Guide

	3M ID	Anti-Loading	Backing	Application		Metal Type		
				Blending	Finishing	Aluminum	Carbon Steel	Non-Ferrous (Brass/Bronze)
Good	341D	—	X wt. Cloth	●	●	●	●	●
Better	236U	Yes	C wt. Paper	●	●	●	●	
	363I	—	F wt. Paper	●	●	●	●	
	348D	—	X wt. Cloth	●		●	●	

3M™ Stikit™ Discs

3M™ Stikit™ Disc Roll 236U

- Aluminum oxide on a C wt. paper backing
- Discs for paint, primer, wood, metal, plastic and fiberglass
- Strong paper backing provides durability and increased cut rate
- Open coat minimizes loading
- Load resistant coating



UPC	Grade	Diameter	Discs/Roll	Qty./Case
Paper Backing				
051144-86488-1	P80	5"	100	4
051144-86489-8	P100			
051144-86490-4	P120			
051144-86491-1	P150			
051144-86492-8	P180			
051144-86493-5	P220			
051144-86494-2	P240			
051144-86495-9	P320			
051144-86496-6	P400			
051144-86497-3	P500			
051144-86468-3	P80	6"	100	4
051144-86469-0	P100			
051144-86470-6	P120			
051144-86471-3	P150			
051144-86472-0	P180			
051144-86473-7	P220			
051144-86474-4	P240			
051144-86475-1	P320			
051144-86476-8	P400			
051144-86477-5	P500			



3M™ Stikit™ Disc Roll 341D

- Aluminum oxide on a durable X wt. cloth backing
- Resin bonded for heat resistance



UPC	Grade	Diameter	Discs/Roll	Qty./Case
Paper Backing				
051144-21752-6	50	5" X NH	100	4
051144-21751-9	60			
051144-21750-2	80			
051144-21749-6	P100			
051144-21748-9	P120			
051144-21746-5	P180	6" X NH	100	4
051144-21762-5	60			
051144-21761-8	80			

See pages 48–55 for available accessories.



3M™ Stikit™ Discs (cont.)

3M™ Stikit™ Disc Roll 363I

- Aluminum oxide on an extra heavy F wt. paper backing
- Resin bonded for heat resistance



105480

UPC	Grade	Diameter	Discs/Roll	Qty./Case
Paper Backing				
051144-21800-4	60	5" x NH	100	4
051144-21799-1	80			
051144-21798-4	P100			
051144-21797-7	P120			
051144-21796-0	P150			
051144-21795-3	P180			
051144-21794-6	60	6" x NH		
051144-21793-9	80			
051144-21792-2	P100			
051144-21791-5	P120			
051144-21790-8	P150			
051144-21789-2	P180			

3M™ PSA Cloth Disc 348D (cont.)

UPC	Grade	Diameter	Min./Case	
Cloth Backing				
051144-20891-3	36	5"	50/250	
051144-20890-6	40			
051144-20889-0	50			
051144-20888-3	60			
051144-20887-6	80			
051144-20886-9	P100			
051144-20885-2	P120			
051144-20884-5	P150			
051144-20883-8	P180	6"		
051144-20881-4	P240			
051144-21639-0	36			
051144-21731-1	40			
051144-20879-1	50			
051144-20878-4	60			
051144-20877-7	80			
051144-20876-0	P100			
051144-21497-6	P120	8"		
051144-20874-6	36			
051144-20873-9	40			
051144-20871-5	60			
051144-20870-8	80			
051144-20868-5	P120			
051144-88906-8	36			12"
051144-88905-1	40			
051144-88904-4	50			
051144-88903-7	60			
051144-88902-0	80			
051144-88901-3	P100			
051144-88890-0	36	16"		
051144-88889-4	40			
051144-88887-0	60			
051144-88886-3	80			
051144-88882-5	36		18"	
051144-88880-1	60			
051144-88878-8	36			20"
051144-88877-1	40			
051144-88876-4	50			
051144-88875-7	60			
051144-88874-0	80			
051144-20802-9	36	24"		
051144-20801-2	40			
051144-20798-5	80			

NEW! 3M™ PSA Discs

3M™ PSA Cloth Disc 348D

- Aluminum oxide on an X wt. cloth backing
- Heavy-duty, cloth-backed discs for more aggressive applications
- Provides excellent adhesion while removing easily



681776

UPC	Grade	Diameter	Min./Case
Cloth Backing			
051144-20913-2	36	2"	50/200
051144-20911-8	50		
051144-20910-1	60		
051144-20909-5	80		
051144-20908-8	P100		
051144-20907-1	P120		
051144-01335-7	40	3"	
051144-01334-0	50		
051144-01333-3	60		
051144-01332-6	80		
051144-01331-9	P100		
051144-01330-2	P120		

See pages 48–55 for available accessories.

ATTENTION: See backup pad maximum operating speed for the appropriate operating speed for the 3M™ Stikit™ and PSA Discs.

3M™ Roloc™ Discs

3M™ Roloc™ Discs provide a fast, efficient method for grinding, blending, leveling and finishing on all types of metal. They lock securely in place with just a half twist...another half twist and they're off. Each disc is color coded by grade. (This does not include 3M Roloc TSM products.)

3M™ Roloc™ Disc Button Color/Grade Chart

- 24/Black
- 80/Yellow
- 150/Black
- 36/Brown
- 100/Blue
- 180/Brown
- 50/Green
- 120/White
- 240/Green
- 60/Orange

■ Mild Steel ■ Stainless Steel

Key: Colored square indicates recommended usage.

3M™ Roloc™ Cloth Disc Selection Guide

	Product ID	Mineral	Features	Metal Type	Grinding	Light Grinding	Blending	Deburring
Good	361F	Aluminum Oxide	General purpose grinding, light grinding, blending, and deburring on all metals	All Metals	●	●	●	●
	461F	Silicon Carbide	Ideal for grinding glass, titanium and non-ferrous metals	Titanium		●	●	●
Better	777F	Ceramic A/O* Blend	Durable Y wt. Cloth backing; Grinding aid	Stainless Steel, Nickel Alloy	●	●	●	●

*A/O – Aluminum Oxide

3M™ Roloc™ Fiber Disc Selection Guide





	Product ID	Mineral	Features	Metal Type	Grinding	Light Grinding	Blending	Deburring
Good	501C	Aluminum Zirconia	Versatile disc for use on a wide variety of metals; General purpose grinding, blending and finishing on all metals	All Metals	●	●		●
Better	785C	Ceramic A/O* Blend	Excellent for stainless steel; Grinding aid	Stainless Steel	●	●		●





*A/O – Aluminum Oxide

Optimum Tool Speeds to Maximize 3M™ Roloc™ Disc Cut Rates and Life

Disc Size	Material Type			
	Stainless	Aluminum	Steel	Titanium
1-1/2"	20,000 RPM	30,000 RPM	30,000 RPM	9,000 RPM
2"	15,000 RPM	20,000 RPM	20,000 RPM	7,000 RPM
3"	10,000 RPM	15,000 RPM	15,000 RPM	4,500 RPM
4"	8,000 RPM	9,000 RPM	9,000 RPM	3,000 RPM

3M™ Roloc™ Attachment System Guide

Product ID	Attachment			
	TP 	TR 	TSM 	TS 
361F	●	●	●	
461F		●		
777F		●	●	●
501C		●	●	
785C		●		

Diameter	Attachment			
	TP 	TR 	TSM 	TS 
3/4"	●	●		●
1"	●	●	●	●
1-1/2"	●	●	●	●
2"	●	●	●	●
3"	●	●	●	●
4"	●	●		●

See pages 48–55 for available accessories.

3M™ Roloc™ Discs (cont.)

3M™ Roloc™ Disc 361F ■



- Aluminum oxide on a YF wt. cloth backing
- General purpose grinding, blending and finishing on all metals



UPC	Grade	Max. RPM	Diameter	Min./Case	
Roloc TR (Plastic Button) 					
051144-11412-2	36	30,000	1"	50/500	
051144-11411-5	50				
051144-11417-7	60				
051144-11416-0	80				
051144-11415-3	P100				
051144-11414-6	P120	30,000	1-1/2"		50/500
051144-11452-8†	24				
051144-22396-1	36				
051144-11137-4	50				
051144-22397-8	60				
051144-22407-4	80	25,000	2"	50/200	
051144-22408-1	P100				
051144-22409-8	P120				
051144-11000-1	24				
051144-22398-5	36				
051144-22399-2	50	20,000	3"		50/200
051144-22400-5	60				
051144-22401-2	80				
051144-22402-9	P100				
051144-22403-6	P120				
051144-14559-1	P150	12,000	4"	25/100	
051144-13873-9	P180				
051144-11419-1	P240				
051144-22392-3	24				
051144-22393-0	36				
051144-22394-7	50	20,000	3"		50/200
051144-22395-4	60				
051144-22404-3	80				
051144-22405-0	P100				
051144-22406-7	P120				
051144-82244-7	P150	12,000	4"	25/100	
051144-11418-4	P240				
051144-76429-7	36				
051144-11421-4	60				
051144-11420-7	80				

† Made-to-Order

3M™ Roloc™ Disc 361F (cont.)

UPC	Grade	Max. RPM	Diameter	Min./Case		
Roloc TSM (Metal Button) 						
051111-49932-0	36	30,000	1-1/2"	50/500		
051111-49933-7	60					
051111-49934-4	80					
051111-51039-1	P100					
051111-51038-4†	P120					
051111-49936-8	36	25,000	2"	50/200		
051111-49937-5	60					
051111-49938-2	80					
051111-51034-6	P100					
051111-49939-9	P120					
051111-51033-9	36	20,000	3"		50/200	
051111-49940-5	60					
051111-49941-2	80					
051111-49942-9	P100					
051111-49943-6	P120					
Roloc TP (Metal Button) 						
051111-82401-4	40	25,000	2"	50/200		
051111-76806-6	60					
051111-76810-3	80					
051111-77115-8†	100	20,000	3"			50/200
051111-22393-0	36					
051111-22394-7	50					
051111-22395-4	60					
051111-22404-3	80					
051111-22405-0	P100					

† Made-to-Order

See pages 48–55 for available accessories.

3M™ Roloc™ Discs (cont.)

3M™ Roloc™ Disc 461F

- Silicon carbide on a YF wt. cloth backing gives stainless steel a brighter finish
- Ideal for grinding glass, titanium and non-ferrous metals



51704



UPC	Grade	Max. RPM	Diameter	Min./Case
Roloc TR (Plastic Button) 				
051144-12956-0	P60	25,000	2"	50/200
051144-12954-6	P80		2"	
051144-12957-7	P60	20,000	3"	
051144-12955-3	P80		3"	

3M™ Roloc™ Fibre Disc 501C

- Aluminum zirconia – Fibre
- Versatile disc for use on a wide variety of metals



159108

UPC	Grade	Max. RPM	Diameter	Min./Case
Roloc TR (Plastic Button) 				
051141-20645-5	36	25,000	2"	50/200
051111-50748-3	50			
051111-50749-0	60			
051111-50750-6	80	20,000	3"	
051111-50743-8	36			
051111-50744-5	50			
051111-50745-2	60			
Roloc TSM (Metal Button) 				
051111-50755-1	36	25,000	2"	50/200
051111-50756-8	50			
051111-50757-5	60			
051111-50758-2	80	20,000	3"	
051111-50751-3	36			
051111-50752-0	50			
051111-50753-7	60			
051111-50754-4	80			



524509

3M™ Roloc™ Disc 777F

- 3M™ Ceramic Aluminum Oxide blend abrasive grain
- Cloth backing for durability
- Grinding aid for cooler running





424847

UPC	Grade	Max. RPM	Diameter	Min./Case
Roloc TR (Plastic Button) 				
051144-76622-2	36	30,000	1"	50/500
051144-76623-9	50			
051144-76624-6	60			
051144-76625-3	80			
051144-80510-5	P120	25,000	2"	
051144-76626-0	36			
051144-76627-7	50			
051144-76628-4	60			
051144-14660-4	80	20,000	3"	50/200
051144-80511-2	P120			
051144-76629-1	36			
051144-76630-7	50			
051144-76433-4	60	25,000	2"	
051144-14661-1	80			
051144-80508-2	P100			
051144-80512-9	P120			
051144-76631-4	36	20,000	3"	50/200
051144-76632-1	50			
051144-76633-8	60			
051144-76634-5	80			
051144-80509-9	P100	25,000	2"	
051144-80513-6	P120			

See pages 48–55 for available accessories.

3M™ Roloc™ Discs (cont.)

3M™ Roloc™ Disc 777F (cont.)

UPC	Grade	Max. RPM	Diameter	Min./Case
Roloc TSM (Metal Button) 				
051111-49949-8	36	25,000	2"	50/200
051111-50253-2	60			
051111-50254-9	80			
051111-50255-6	100			
051111-50256-3	P120			
051111-50257-0	36	20,000	3"	
Roloc TP (Metal Button) 				
051144-76770-0†	60	25,000	2"	50/200
051144-76743-4†	36	20,000	3"	
051144-76763-2†				
051144-76767-0†				
051144-76767-0†				
Roloc TS (Plastic Button) 				
051144-76742-7	36	25,000	2"	50/200
051144-76746-5	50			
051144-76750-2	60			
051144-76743-4†	36	20,000	3"	
051144-76747-2†	50			
051144-76751-9	60			
051144-76755-7	80			

† Made-to-Order

3M™ Roloc™ Fibre Disc 785C ■

- 3M™ Ceramic Aluminum Oxide blend abrasive grain – Fibre
- An excellent starting point for stainless steel
- Includes a grinding aid for cooler running

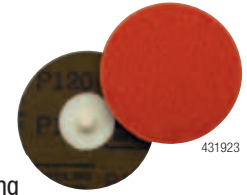

UPC	Grade	Max. RPM	Diameter	Min./Case
Roloc TR (Plastic Button) 				
051144-85882-8†	24	20,000	3"	50/100
051144-85883-5	36			
051144-85884-2	50			
051144-85885-9	60			
051144-85886-6	80			
051144-85887-3	P100	12,000	4"	50/200
051144-85888-0	P120			
051144-83690-1	36	12,000	4"	25/100
051144-83691-8	50			
051144-83692-5	60			
051144-83693-2	80			
051144-83694-9	P100			
051144-83695-6	P120			

† Made-to-Order

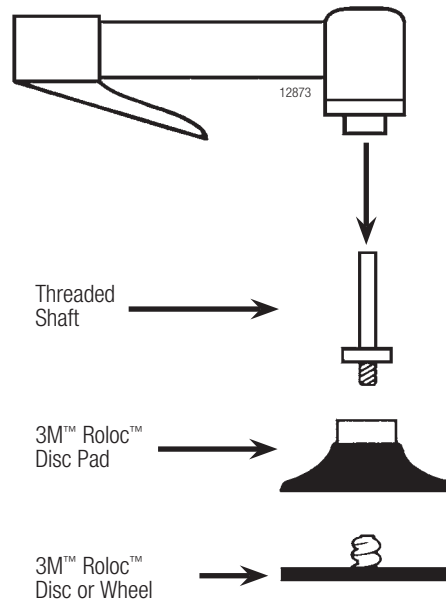

See pages 48–55 for available accessories.

14494



84685

3M™ Belts

3M is the one-stop shop for all of your coated abrasive metalworking belt needs! We offer a product tailored to nearly every application and performance level. To select the best product for your application, check out our easy-to-use Belt Selection Guide. Each tier of product offers best-in-class performance at various price points. Once you have selected the product, use the Availability Guide to select your grade. The following section includes our most popular belt items, but remember, we can provide any size belt that you might need!

Abrasive Speed Recommendations for Off-Hand Applications

Alloy	Belt Speed (surface feet per minute)	Applicable Belt Grades
Cast Iron	7,000	24–120
Carbon Steel	6,500	24–120
Stainless Steel	6,500–7,000	36–120
Nickel Alloys	6,000	36–120
Titanium	2,500–3,000	36–180
Aluminum	7,500–8,500	24–120
	6,500–7,000	Fine Grades
Brass	7,000–8,000	36–180
Rubber	4,500	36–180
Glass	2,500–5,000	80–400
	6,000–8,000	
Stone	7,000	36–180

Tech Tip

Keep Things Cool — When working on heat sensitive alloys like stainless steel, nickel alloys and cobalt alloys, choose a product with a grinding aid.

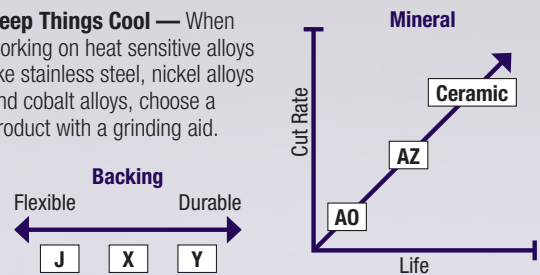

3M™ Coated Belt Availability Guide

3M ID	Mineral	Backing	Grinding Aid	Use Dry/Wet	400	320	240	220	180	150	120	100	80	60	50	40	36	24
241E	Aluminum Oxide	XE		Dry		P		P	P	P	P	P	●					
341D		X		Dry	P	P	P	P	P	P	P	P	●	●	●	●	●	●
577F	Alumina Zirconia	YF	Yes	Dry/Wet					●	●	●	●	●	●	●	●	●	●
777F	Ceramic A/O* Blend	YF	Yes	Dry/Wet					P	P	P	P	●	●	●	●	●	●

*A/O – Aluminum Oxide

ATTENTION: Belts are available in other grades and sizes. If you need a specific belt not listed, contact your 3M Sales Specialist or 3M Authorized Distributor.

See pages 48–55 for available accessories.

3M™ Belts (cont.)

241E

- Aluminum oxide on an XE wt. cloth backing
- High strength backing for tougher applications
- Use with 3M™ File Belt Sander



UPC	Grade	W x L	Min./Case
Portable Tool			
051144-26733-0	60	1/4" x 24"	50/200
051144-26732-3	80		
051144-26731-6	120		
051144-31170-5	60	1/2" x 12"	
051144-26894-8†	80		
051144-26892-4†	120		
051144-72227-3†	60	1/2" x 18"	
051144-72228-0	80		
051144-72229-7†	120		
051144-26725-5†	50	1/2" x 24"	
051144-26723-1	60		
051144-26720-0	80		
051144-26719-4	100		
051144-26717-0†	120		
051144-26715-6	180		
051144-26714-9	220		
051144-14756-4	60		3/4" x 18"
051144-14519-5	80		
051144-14667-3	120		

† Made-to-Order

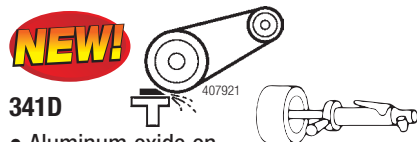

341D

- Aluminum oxide on an X wt. cloth backing
- Excellent all-around abrasive belt for blending and finishing



UPC	Grade	W x L	Min./Case
Backstand, Benchtop, Portable Tool			
051144-26614-2	36	1" x 42"	50/200
051144-31823-0	50		
891040-01450-7	60		
891040-01451-4	80		
891040-01452-1	P100		25/100
891040-01453-8	P120		
051144-26602-9	P150		
051144-26601-2	P180		50/200
051144-26599-2	P240		
051144-26597-8	P320		

See pages 48–55 for available accessories.

341D (cont.)

UPC	Grade	W x L	Min./Case		
Backstand, Benchtop, Portable Tool					
051144-26443-8	36	1-1/2" x 60"	10/50		
051144-26441-4	40				
051144-26438-4	60		25/50		
051144-26436-0	80				
051144-26571-8	36	2" x 48"	10/50		
051144-26568-8	50				
051144-26564-0	60		25/50		
051144-26562-6	80				
051144-26561-9	P100				
051144-26560-2	P120	2" x 60"	10/50		
051144-26424-7	50				
051144-33640-1	60		25/50		
051144-33639-5	80				
051144-33667-8	P120				
051144-26320-2	36	2" x 72"	10/50		
051144-26316-5	60				
051144-33067-6	80		25/50		
051144-26312-7	P120				
051144-26309-7	P180				
051144-81752-8	P240				
051144-26408-7	36			2-1/2" x 60"	10/50
051144-26400-1	60				
051144-26396-7	80	25/50			
051144-26388-2	P120				
051144-26857-3	60	3-1/2" x 15-1/2"	10/50		
051144-26856-6	80				
891040-02663-0	P120				
891040-01436-1	36	4" x 24"	25		
891040-01439-2	60		50		
891040-01440-8	80	4" x 132"	25		
051144-33647-0	60				
891040-01454-5	36	6" x 48"	10/20		
891040-01455-2	40				
891040-01456-9	50				
891040-01457-6	60				
891040-10454-3	80			20	
891040-10455-0	P100				
891040-10456-7	P120				
051144-26517-6	P150				
051144-26515-2	P180				
051144-26513-8	P240		37" x 60"	5	
051144-74271-4	P120	3			
051144-14420-4	80	37" x 75"		5	
051144-33061-4	P120				
051144-14508-9	P180				

3M™ Belts (cont.)

577F

- Alumina zirconia on a YF wt. cloth backing
- Resin bonded for heat resistance
- Features a grinding aid for cooler grinding
- Can be run wet or dry



UPC	Grade	W x L	Qty./Case
051141-30690-2	60	1/4" x 18"	50/200
051141-30691-9	80		
051141-30708-4	120		
051141-30694-0	60	1/4" x 24"	
051119-05580-1	80		
051141-30695-7	120		
051111-68668-3	60	1/2" x 12"	
051111-68695-9	80		
051141-30709-1	120		
051141-30686-5	36	1/2" x 18"	
051119-63081-7	60		
051119-82035-5	80		
051141-30689-6	120		
051141-30693-3	36	1/2" x 24"	
051111-68669-0	60		
051111-68696-6	80		
051111-69436-7	120	3/4" x 18"	
051141-30687-2	36		
051115-19553-2	60		
051125-19076-3	80		
051141-30688-9	120	3/4" x 20-1/2"	
051125-16745-1	60		
051111-68697-3	80		
051125-22333-1	120	1" x 18"	
051119-71425-8	60		
051125-23878-6	80		
051141-30692-6	120		
051115-19554-9	60	2" x 48"	25/50
051119-05579-5	80		
051125-11238-3	120		
051141-30699-5	36	2" x 60"	
051111-69103-8	60		
051141-30703-9	80		
051141-30704-6	120		

577F (cont.)

UPC	Grade	W x L	Qty./Case
051141-30698-8	36	2" x 72"	25/50
051111-69104-5	60		
051141-30701-5	80		
051141-30697-1	120		
051111-67602-8	36	2" x 132"	
051141-30702-2	50		
051111-69105-2	60		
051111-69108-3	80		
051141-30696-4	120	2-1/2" x 60"	
051119-64999-4	36		
051111-69106-9	60		
051125-12707-3	80		
051141-30706-0	120	3" x 132"	
051111-69099-4	36		
051119-82066-9	50		
051111-69569-2	60		
051111-69571-5	80	3-1/2" x 15-1/2"	
051111-67681-3	120		
051119-67701-0†	60		
051119-58968-9†	80	4" x 132"	
051119-67700-3†	120		
051111-67604-2	36	4" x 132"	
051115-27562-3	50		
051111-69570-8	60		
051111-69573-9	80		
051125-23987-5	120	6" x 48"	
051111-69445-9	60		
051119-83855-8	80		
051141-30707-7	120		

† Made-to-Order

777F

- 3M™ Ceramic Aluminum Oxide blend abrasive grain on a YF wt. cloth backing
- Contains grinding aid which enhances performance on stainless steel and other exotic alloys
- Can be run wet or dry

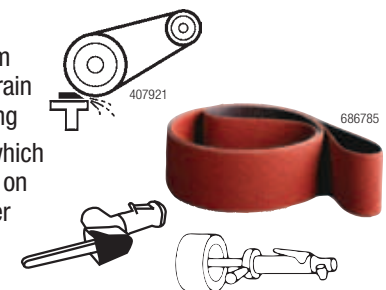

UPC	Grade	W x L	Min./Case
Backstand, Benchtop, Portable Tool			
051144-84403-6	60	1/4" x 18"	200
051144-85318-2	80		
051144-19579-2	P120		

See pages 48–55 for available accessories.

3M™ Belts (cont.)

777F (cont.)

UPC	Grade	W x L	Min./Case
Backstand, Benchtop, Portable Tool			
051144-84412-8	40	1/4" x 24"	200
051144-80253-1	60		
051144-77642-9	80		
051144-82229-4	P120	1/2" x 12"	
051111-69457-2	60		
051144-85372-4	80		
051111-69604-0	P120	1/2" x 18"	
051144-84301-5	36		
051144-84409-8	40		
051144-80551-8	60	1/2" x 24"	
051144-80232-6	80		
051144-84304-6	P120		
051144-77643-6	36	1/2" x 24"	
051144-82342-0	40		
051144-77408-1	50		
051144-77065-6	60	3/4" x 18"	
051144-77491-3	80		
051144-81064-2	P120		
051144-84302-2	36	3/4" x 18"	
051144-84404-3	60		
051144-77992-5	80		
051144-84303-9	P120	3/4" x 20-1/2"	
051144-80486-3	60		
051144-80686-7	80		
051125-23897-7	60	1" x 18"	
051144-85319-9	80		
051141-30705-3	P120		
051144-76527-0	40	1" x 42"	50/200
051144-77512-5	60		
051144-14895-0	80		
051144-84416-6	60	1-1/2" x 60"	25/50
051144-76731-1	80		
051144-82022-1	P120		
051144-76738-0	36	2" x 48"	10/50
051144-76519-5	60		
051144-14896-7	80		
051144-85393-9	P120	2" x 48"	25/50
051144-77663-4	36		
051144-77152-3	60		
051144-84296-4	80	2" x 60"	50
051144-85377-9	P120		

777F (cont.)

UPC	Grade	W x L	Min./Case
Backstand, Benchtop, Portable Tool			
051144-76531-7	36	2" x 72"	50
051144-80286-9	60		
051144-14884-4	80		
051144-81767-2	P120	2" x 132"	
051144-14264-4	36		
051144-14899-8	50		
051144-82231-7	60	2" x 132"	
051144-14534-8	80		
051144-81687-3	P120		
051144-84315-2	P180	2-1/2" x 60"	
051144-76532-4	36		
051144-77825-6	40		
051144-76680-2	60	2-1/2" x 60"	
051144-76686-4	80		
051115-27389-6	P120		
051144-76533-1	36	3" x 132"	25
051111-69455-8	50		
051144-76520-1	60		
051144-76514-0	80	3-1/2" x 15-1/2"	
051144-80028-5	P120		
051144-85762-3	P180		
051144-77336-7	36	3-1/2" x 15-1/2"	
051144-77334-3	50		
051144-77476-0	60		
051144-77333-6	80	3-1/2" x 15-1/2"	
051144-84306-0	100		
051144-84307-7	P120		
051144-85320-5	P180	4" x 132"	50
051144-76534-8	36		
051111-67851-0	50		
051144-80707-9	60	4" x 132"	25
051144-76515-7	80		
051141-30700-8	P120		
051144-82313-0	36	6" x 48"	10/20
051144-80176-3	50		
051144-76679-6	60		
051144-76733-5	80	6" x 48"	20
051144-82153-2	P120		

ATTENTION: Belts are available in other grades and sizes. If you need a specific belt not listed, contact your 3M Sales Specialist or 3M Authorized Distributor.

See pages 48–55 for available accessories.

Utility Cloth Sheets and Rolls

A good choice for all your utility sanding and general maintenance work. Can be torn and rolled without shelling.

3M™ Utility Cloth Sheet and Roll Selection Guide

	Product ID	Mineral	Backing	Features	Blending	Finishing	Cleaning
Good	011K	Aluminum Oxide	Flexible Utility Cloth	Closed Coat; General purpose use	●	●	●
Better	211K	Aluminum Oxide	Flexible Utility Cloth	Use for all general maintenance work		●	
Best	314D	Premium Aluminum Oxide	Durable Cloth	Strong bonding system for shelling resistance	●	●	●

3M™ Utility Cloth Sheets 011K

- Aluminum oxide mineral
- General purpose use



UPC	Grade	W x L	Min./Case
Sheets			
051144-02433-9	CRS	9" x 11"	50/250
051144-02432-2	MED		
051144-02431-5	FINE		

3M™ Utility Cloth Sheets and Rolls 211K

- Aluminum oxide on a J wt. cloth backing
- Use these flexible utility rolls and sheets for general applications such as deburring, rust removal, strapping and all general maintenance work



UPC	Grade	W x L	Min./Case
Sheets			
051144-02410-0	80	9" x 11"	50/250
051144-02409-4	100		
051144-02408-7	120		
051144-02407-0	150		
051144-02406-3	180		
051144-02405-6	220		
051144-02404-9	240		
051144-02402-5	320		
051144-12501-2	400		
051144-12500-5	500		

3M™ Utility Cloth Sheets and Rolls 211K (cont.)

UPC	Grade	W x L	Min./Case
Utility Rolls			
051144-05010-9	80	1" x 50 yds.	
051144-05009-3	100		
051144-05008-6	120		
051144-05007-9	150		
051144-05006-2	180		
051144-05005-5	220		
051144-05004-8	240		
051144-05003-1	280		
051144-05002-4	320		
051144-05001-7	400		
051144-05000-0	500	1-1/2" x 50 yds.	1/5
051144-05030-7	80		
051144-05029-1	100		
051144-05028-4	120		
051144-05027-7	150		
051144-05026-0	180		
051144-05025-3	220		
051144-05024-6	240		
051144-05022-2	320		
051144-05021-5	400		
051144-05020-8	500		
051144-05050-5	80		
051144-05049-9	100		
051144-05048-2	120		
051144-05047-5	150		
051144-05046-8	180		
051144-05045-1	220		
051144-05044-4	240		
051144-05042-0	320		
051144-05041-3	400		
051144-05040-6	500		

See pages 48–55 for available accessories.

Utility Cloth Sheets and Rolls (cont.)

3M™ Utility Cloth Sheets and Rolls 314D

- Aluminum oxide on X and J wt. cloth backings
- Ideal for all utility jobs
- Can be torn into strips and rolled without shelling



380124

UPC	Grade	Backing	W x L	Min./Case			
Sheets							
051115-19775-8	P40	X wt.	9" x 11"	50/250			
051115-19774-1	P50						
051115-19773-4	P60						
051115-19772-7	P80	J wt.					
051115-19771-0	P100						
051115-19770-3	P120						
051115-19769-7	P150						
051115-19768-0	P180						
051115-19767-3	P220						
051115-19766-6	P240						
051115-19765-9	P280						
051115-19764-2	P320						
051115-19763-5	P400						
Utility Rolls							
051115-19794-9	P50				X wt.	1" x 50 yds.	1/5
051115-19793-2	P60	J wt.					
051115-19792-5	P80						
051115-19791-8	P100						
051115-19790-1	P120						
051115-19789-5	P150						
051115-19788-8	P180						
051115-19787-1	P220						
051115-19786-4	P240						
051115-19785-7	P280						
051115-19784-0	P320						
051115-19783-3	P400						

3M™ Utility Cloth Sheets and Rolls 314D (cont.)

UPC	Grade	Backing	W x L	Min./Case			
Utility Rolls							
051115-19813-7	P50	X wt.	1-1/2" x 50 yds.	1/5			
051115-19812-0	P60						
051115-19811-3	P80	J wt.					
051115-19810-6	P100						
051115-19809-0	P120						
051115-19808-3	P150						
051115-19807-6	P180						
051115-19806-9	P220						
051115-19805-2	P240						
051115-19804-5	P280						
051115-19803-8	P320						
051115-19802-1	P400						
051115-19826-7	P40				X wt.	2" x 50 yds.	1/5
051115-19825-0	P50						
051115-19824-3	P60						
051115-19823-6	P80	J wt.					
051115-19822-9	P100						
051115-19821-2	P120						
051115-19820-5	P150						
051115-19819-9	P180						
051115-19818-2	P220						
051115-19817-5	P240						
051115-19816-8	P280						
051115-19815-1	P320						
051115-19814-4	P400						

ATTENTION: Belts are available in other grades and sizes. If you need a specific belt not listed, contact your 3M Sales Specialist or 3M Authorized Distributor.

See pages 48–55 for available accessories.

3M™ Wetordry™ Sheets

Still a favorite for their reduced loading, long life and great finish. Good general use abrasive for hand or machine sanding. Can be run wet or dry.

3M™ Wetordry™ Sheet Selection Guide

Product ID	Mineral	Backing	Blending	Finishing
431Q	Silicon Carbide	C wt. Paper	●	
413Q		A wt. Paper		●

3M™ Wetordry™ Sheets 413Q

- Silicon carbide on an A wt. paper backing
- Reduced clogging eliminates dust when used wet
- Excellent conformability



UPC	Grade	W x L	Min./Case
051144-02007-2	220	9" x 11"	50/500
051144-02006-5	240		50/250
051144-02005-8	280		50/500
051144-02004-1	320		50/250
051144-02003-4	360		50/500
051144-02002-7	400		50/500

3M™ Wetordry™ Paper Sheets 431Q

- Silicon carbide on a C wt. paper backing
- Reduced clogging eliminates dust when used wet
- Heavyweight paper backing for increased durability



UPC	Grade	W x L	Min./Case
051144-02018-8	80	9" x 11"	50/250
051144-02017-1	100		
051144-02016-4	120		
051144-02015-7	150		
051144-02014-0	180		

3M™ Paper Sheets

Conformable and versatile, 3M™ Paper Sheets are ideal for hand or machine sanding. Various constructions available for use on wood, metal, paint, plastic and fiberglass.

3M™ Paper Sheet Selection Guide

	Product ID	Mineral	Backing	Blending	Finishing
Good	210N	Aluminum Oxide	A wt. Paper		●
Better	336U	Aluminum Oxide	C wt. Paper	●	
Best	346U	Aluminum Oxide	D wt. Paper	●	

3M™ Paper Sheets 210N

- Aluminum oxide on an A wt. paper backing
- Open Coat
- Provides exceptional conformability for contour sanding



UPC	Grade	W x L	Min./Case
051144-02104-8	180	9" x 11"	100/1000
051144-02103-1	220		

3M™ Paper Sheets 336U

- Aluminum oxide on a C wt. paper backing
- Medium-weight sheets for general-purpose sanding
- Open coat resists loading on soft materials



UPC	Grade	W x L	Min./Case
051144-02114-7	100	9" x 11"	100/1000
051144-02113-0	120		
051144-02112-3	150		

3M™ Paper Sheets 346U

- Aluminum oxide on a D wt. paper backing
- Ideal for hand or machine sanding of many different materials, including woods, metals, paints, plastics and fiberglass

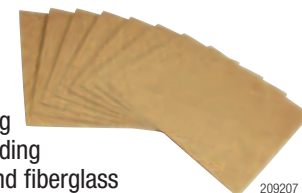

UPC (051144-)	Grade	W x L	Min./Case
051144-02119-2	36	9" x 11"	50/250
051144-02118-5	40		
051144-02117-8	50		50/500
051144-02116-1	60		
051144-02115-4	80		

See pages 48–55 for available accessories.

3M™ Flap Wheels

Coated Abrasive flap wheels are the ideal choice for light grinding, blending, graining and scale removal on a variety of metals. The abrasive flaps offer a long lasting supply of fresh abrasives and a load resistant design. Available in both flange mounted and spindle mounted constructions with general purpose aluminum oxide or high performing 3M™ Ceramic Aluminum Oxide blend abrasive grain.

3M™ Flange Mounted Flap Wheel Selection Guide

	Material	Product ID	Mineral	Grade
Better	Carbon Steel	241E	Aluminum Oxide	50-320
		244E	Aluminum Oxide	60-120
Best	Stainless Steel	741A	Ceramic Aluminum Oxide Blend	50-120

3M™ Flange Mounted Flap Wheels

3M™ Flap Wheels 241E/244E

- Aluminum oxide on a flexible XE wt. cloth backing
- Long life and fast cut
- General purpose flap wheels at a value price



51742

UPC	Grade	Max. RPM	Dia. x W x AH	Qty./Case
051144-35113-8	60	6,100	6" x 1" x 1"	5
051144-35112-1	80			
051144-35111-4	100			
051144-35109-1	120			
051144-35088-9	60	5,200	6" x 2" x 1"	
051144-35086-5	80			

Additional sizes are available.

3M™ Flap Wheels 741A

- 3M™ Ceramic Aluminum Oxide blend abrasive grain on a durable X wt. cloth backing
- Longer life and faster cut



51742

UPC	Grade	Max. RPM	Dia. x W x AH	Qty./Case
051144-82770-1	50	6,100	6" x 1" x 1"	5
051144-81986-7	60			
051144-81984-3	80			

Additional sizes are available.

3M™ Flap Wheels 241E/244E and 741A can be made-to-order in the following sizes:

Diameter	Arbor Hole
> 3" – 4-1/2"	5/8"
> 4-1/2" – 6"	1"
> 6" – 8"	1" or 1-1/4"
> 8" – 10"	1-3/4" or 2"

See pages 48–55 for available accessories.



524290



3M™ Spindle Mounted Flap Wheel Selection Guide

	Material	Product ID	Mineral	Grade
Better	Carbon Steel	244D	Aluminum Oxide	60-120
Best	Stainless Steel	747D	Ceramic Aluminum Oxide Blend	36-150

3M™ Spindle Mounted Flap Wheels

3M™ Flap Wheels 244D — T83 and T84

- Aluminum oxide
- General purpose flap wheel delivers consistent finish and uniform cut



UPC	Grade	Max. RPM	Dia. x W x Shk	Qty./Case
T83; 1/4" Straight				
051144-35475-7	60	30,000	1" x 1" x 1/4"	10
051144-35476-4	80			
051144-35477-1	120			
051144-14623-9	60	25,000	2" x 1" x 1/4"	
051144-14624-6	80			
051144-14625-3	120			
051144-14655-0	60	20,000	3" x 1" x 1/4"	
051144-14656-7	80			
051144-14657-4	120			
T84; 1/4-20 Threaded				
051144-35467-2	60	30,000	1" x 1" x 1/4-20 EXT	10
051144-35468-9	80			
051144-35469-6	120			
051144-14575-1	60	25,000	2" x 1" x 1/4-20 EXT	
051144-14576-8	80			
051144-14607-9	60			
051144-14608-6	80	20,000	3" x 1" x 1/4-20 EXT	

3M™ Flap Wheels 747D — T83 and T84

- 3M™ Ceramic Aluminum Oxide blend abrasive grain on a resin-bonded X wt. cloth backing
- Includes a grinding aid for cooler running on stainless steel



UPC	Grade	Max. RPM	Dia. x W x Shk	Qty./Case
T83; 1/4" Straight				
051144-80761-1	60	30,000	1" x 1" x 1/4"	10
051144-80757-4	80			
051144-80753-6	P120			
051144-80763-5	60	25,000	2" x 1" x 1/4"	
051144-80759-8	80			
051144-80755-0	P120			
051144-80650-8	60	20,000	3" x 1" x 1/4"	
051144-80651-5	80			
051144-80652-2	P120			
T84; 1/4-20 Threaded				
051144-83271-2	60	25,000	2" x 1" x 1/4-20 EXT	10
051144-83268-2	80			
051144-83265-1	P120			
051144-83269-9	60	20,000	3" x 1" x 1/4-20 EXT	
051144-83267-5	80			
051144-83263-7	P120			

See pages 48-55 for available accessories.

3M™ Cartridge Rolls

Cartridge rolls are ideal for getting into small, hard to reach spaces. As they wear, the wrapped layers of the cartridge roll continuously expose fresh abrasive layers for continued cutting action. Available in regular and tapered construction.

3M™ Cartridge Rolls 341D

- Aluminum oxide on an X wt. cloth backing
- Long life and fast cut
- General purpose cartridge rolls at a value price



51754

UPC	Grade	Max. RPM	Dia. x L x CH	Qty./Case
Regular				
051144-96959-3	P60	24,000	1/4" x 1" x 1/8"	100
051144-14021-3	P80			
051144-96961-6	P120			
051144-96963-0	P180			
051144-96968-5	P60			
051144-96969-2	P80			
051144-96971-5	P120		1/4" x 1-1/2" x 1/8"	
051144-96973-9	P180			
051144-14024-4	P60			
051144-14023-7	P80			
051144-14022-0	P120			
051144-97008-7	P180			
051144-97013-1	P60			
051144-20417-8	P80			
051144-97015-5	P120			
051144-97017-9	P180			
051144-97041-4	P60		3/8" x 1-1/2" x 1/8"	
051144-97042-1	P80			
051144-97044-5	P120			
051144-14028-2	P60			
051144-14027-5	P80			
051144-14026-8	P120	1/2" x 1" x 1/8"		
051144-97059-9	P180			
051144-97162-6	P60		1/2" x 1-1/2" x 1/8"	
051144-97163-3	P80			
051144-97165-7	P120			
			16,000	3/4" x 1-1/2" x 3/16"



3M™ Cartridge Rolls 341D (cont.)

UPC	Grade	Max. RPM	Dia. x L x CH	Qty./Case	
Full Taper					
051144-97239-5	P60	24,000	3/8" x 1" x 1/8"	100	
051144-97240-1	P80				
051144-97242-5	P120				
051144-97244-9	P180				
051144-97248-7	P60		3/8" x 1-1/2" x 1/8"		
051144-97249-4	P80				
051144-97251-7	P120				
051144-97257-9	P60				1/2" x 1" x 1/8"
051144-97259-3	P120				
051144-14034-3	P60		1/2" x 1-1/2" x 1/8"		
051144-14033-6	P80				
051144-14032-9	P120				
051144-97267-8	P180				

3M™ Cartridge Rolls 747D

- 3M™ Ceramic Aluminum Oxide blend abrasive grain on an X wt. cloth backing
- Long life and fast cut
- Contains grinding aid for cooler cutting on heat sensitive alloys



14378

UPC	Grade	Max. RPM	Dia. x L x CH	Qty./Case
Regular				
051144-80790-1	60	24,000	1/2" x 1-1/2" x 1/8"	100
051144-80796-3	80			
051144-80792-5	P120			
Full Taper				
051144-80786-4	60	24,000	1/2" x 1-1/2" x 1/8"	100
051144-80787-1	80			
051144-80788-8	P120			

See pages 48–55 for available accessories.

3M™ Cross and Square Pads

Cross pads are used for close tolerance polishing of small radii and channels, deburring the ends and insides of tubing, and other special applications.

Square pads are ideal for fast grinding/blending of channels, fillets, and corners, plus spotting on flat surfaces. As the square pads rotate, the corners exert a fast biting action and gradually wear down to expose fresh abrasive material.

3M™ Square Pads 341D

- Premium aluminum oxide on an X wt. cloth backing
- Long life and fast cut
- General purpose square pads at a value price



UPC	Grade	Max RPM	Size	Min./Case
1/4"– 20 Eyelet				
051141-27353-2†	60	12,000	2" x 2" x 3/8"	50/100
051141-27354-9†	80			
051141-27355-6†	P120		2" x 2" x 1/2"	
051141-27350-1	60			
051141-27351-8	80	9,000	3" x 3" x 1/4"	
051141-27352-5	P120			
051144-97723-9		9,000	3" x 3" x 1/2"	
051141-27356-3†	60			
051141-27357-0†	80			
051141-27358-7†	P120			

† Made-to-Order

3M™ Square Pads 747D

- 3M™ Ceramic Aluminum Oxide blend abrasive grain on an X wt. cloth backing
- Super aggressive cut rate and durability
- Contains grinding aid for cooler cutting on heat sensitive alloys



UPC	Grade	Max RPM	Size	Qty./Case
1/4"– 20 Eyelet				
051141-27359-4†	60	12,000	2" x 2" x 1/2"	100
051141-27360-0†	80			
051141-27361-7†	P120		2" x 2" x 3/8"	
051141-27362-4†	60			
051141-27363-1†	80	9,000	3" x 3" x 1/2"	
051141-27364-8†	P120			
051141-27365-5†	60			
051141-27366-2†	80			
051141-27367-9†	P120			

† Made-to-Order

3M™ Cross Pads 341D

- Premium aluminum oxide on an X wt. cloth backing
- Long life and fast cut
- General purpose square pads at a value price



UPC	Grade	Max RPM	Size	Min./Case	
8 or 10 Ply; 8"– 32 Eyelet					
051141-27368-6	60	24,000	1" x 1" x 3/8"	50/100	
051141-27369-3	80				
051141-27370-9†	P120		1-1/2" x 1-1/2" x 1/2"		
051141-27371-6	60				
051141-27372-3	80				
051141-27373-0	P120				
10 Ply; 8"– 32 Eyelet					
051141-27374-7	60	18,000	2" x 2" x 1/2"		50/100
051141-27375-4	80				
051141-27376-1	P120		2" x 2" x 3/4"		
051141-27377-8	60				
051141-27378-5	80	9,000	2-1/2" x 2-1/2" x 3/4"		
051141-27379-2	P120				
051144-97750-5	60				
8 or 10 Ply; 1/4"– 20 Eyelet					
051141-27380-8	60	18,000	3" x 3" x 1"	50/100	
051141-27381-5	80				
051141-27382-2†	P120		3" x 3" x 1-1/2"		
051144-97760-4	60				
051144-97766-6	80	15,000	3-1/2" x 3-1/2" x 1-1/2"		
051144-97768-0		12,000	4" x 4" x 1"		
051144-98880-2	60	10,000	5" x 5" x 1-1/2"		
051144-97783-3		9,000	6" x 6" x 1-1/2"		

† Made-to-Order

3M™ Cross Pads 747D

- 3M™ Ceramic Aluminum Oxide blend abrasive grain on an X wt. cloth backing
- Super aggressive cut rate and durability
- Contains grinding aid for cooler cutting on heat sensitive alloys



UPC	Grade	Max RPM	Size	Qty./Case
8 Ply; 1/4"– 20 Eyelet				
051141-20368-3	60	24,000	1-1/2" x 1-1/2" x 1/2"	100
051141-20369-0	80			
051141-20372-0	P100			
051141-20379-9	P120	18,000	2" x 2" x 1/2"	
051141-20380-5	60			
051141-20367-6	P100	80	2" x 2" x 3/4"	
051141-20375-1	80			

† Made-to-Order

See pages 48–55 for available accessories.

3M™ Bands

Great for getting at those hard-to-reach places and contours. Ideal for removing parting lines, imperfections and burrs. Use with 3M™ Die Grinders and 3M™ Rubber Slotted Expander Wheel or 3M™ Rubber Cushion Polishing Wheel.

3M™ Bands 341D

- Aluminum oxide on and X wt. cloth backing
- Fast cut and long life
- General purpose evenrun bands at a value price



UPC	Grade	Max. RPM	Dia. x W	Qty./Case
051144-40243-4	P80	23,000	1/4" x 1/2"	100
051144-97428-3	P120			
051144-27446-7	P36	30,000	1/2" x 1/2"	
051144-40228-1	P60			
051144-40227-4	P80			
051144-40252-6	P120			
051144-97458-0	P36	15,000	1/2" x 1"	
051144-40225-0	P60			
051144-40224-3	P80			
051144-11973-8	P120			
051144-11976-9	P36	17,000	3/4" x 1"	
051144-40221-2	P60			
051144-40220-5	P80			
051144-40219-9	P120			
051144-11977-6	P36	10,000	3/4" x 1-1/2"	
051144-40241-0	P80			
051144-40214-4	P36	18,000	1" x 1"	
051144-40211-3	P60			
051144-40210-6	P80			
051144-40208-3	P120			
051144-40207-6	P36	10,000	1" x 1-1/2"	
051144-11980-6	P60			
051144-40205-2	P80			
051144-40203-8	P36			
051144-40202-1	P60	14,000	1-1/2" x 1"	
051144-40200-7	P36			
051144-40197-0	P60	10,000	1-1/2" x 1-1/2"	
051144-40196-3	P80			
051144-40274-8	P120			

3M™ Bands 341D (cont.)

UPC	Grade	Max. RPM	Dia. x W	Qty./Case
051144-40267-0	P60	8,000	1-1/2" x 2"	
051144-40192-5	P60	11,000	2" x 1"	
051144-40187-1	P36	6,000	2" x 2"	
051144-40184-0	P60			
051144-40183-3	P80	3,000	3" x 3"	50
051144-40178-9	P36			
051144-40175-8	P60			
051144-40174-1	P80			
051144-40172-7	P120			

3M™ Bands 747D

- 3M™ Ceramic Aluminum Oxide blend abrasive grain on an X wt. cloth backing
- Long life and fast cut
- Contains grinding aid for cooler cutting on heat sensitive alloys



UPC	Grade	Max. RPM	Dia. x W	Qty./Case
051144-80765-9	50	15,000	1/2" x 1"	100
051144-80769-7	60			
051144-80773-4	80			
051144-80766-6	50	18,000	1" x 1"	
051144-80770-3	60			
051144-80774-1	80			
051144-80782-6	P120			
051144-80771-0	60	11,000	2" x 1"	
051144-80775-8	80			
051144-80783-3	P120			

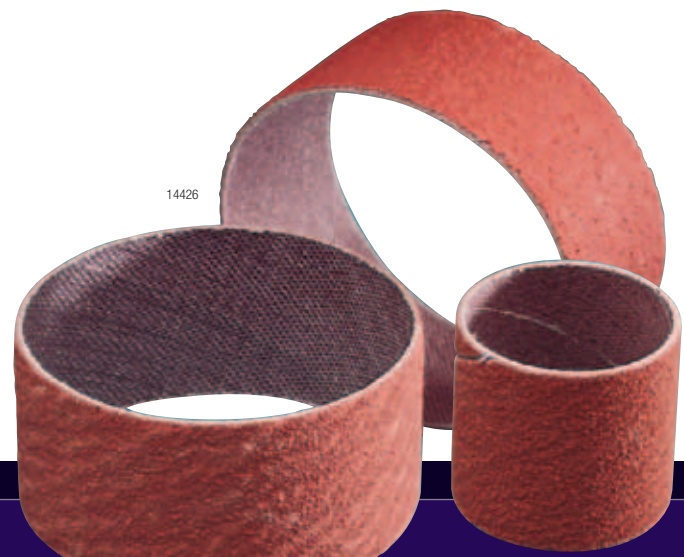

See pages 48–55 for available accessories.

Scotch-Brite™ Discs



Make tough jobs easier. Scotch-Brite™ Discs can help you achieve a burr-free, paintable finish in fewer steps without damaging the base material. The non-woven, open web, durable construction is designed to resist loading and greatly increase the life of the disc. As a result, you will not have to change it as often. However, when you do change your disc, the Roloc™ attachment or Hook-and-Loop attachment makes it fast and easy.

Scotch-Brite™ Roloc™ Discs

Scotch-Brite™ Roloc™ SC Surface Conditioning Discs

- Scotch-Brite surface conditioning non-woven web provides a burr-free decorative finish
- Removes grind marks, rust and coatings
- Grade: A VFN – Blue; A MED – Maroon; A CRS – Brown



UPC	Grade	Max. RPM	Diameter	Min./Case
Roloc TP (Metal Button) 				
048011-13237-2	A CRS	25,000	2"	50/200
048011-13241-9		18,000	3"	25/100
048011-13243-3†	A VFN			
Roloc TR (Plastic Button) 				
048011-15393-3	A CRS	30,000	1"	200
048011-15392-6	A MED			
048011-15391-9	A VFN			
048011-15568-5†	A SFN		1-1/2"	
048011-08764-1	A CRS			
048011-08765-8	A MED	25,000	2"	50/200
048011-08766-5	A VFN			
048011-08767-2†	A SFN			
048011-05528-2	A CRS			
048011-05527-5	A MED			
048011-05522-0	A SFN			
048011-05523-7	A VFN			
048011-05532-9	A CRS			
048011-05531-2	A MED	12,000	4"	100
048011-05529-9	A SFN			
048011-05530-5	A VFN			
048011-12954-9	A CRS			
048011-12953-2	A MED			
048011-12951-8†	A SFN	30,000	1-1/2"	50/200
048011-25775-4	A CRS			
048011-25774-7†	A MED			
048011-25773-0†	A VFN			

† Made-to-Order

Scotch-Brite™ Roloc™ SC Surface Conditioning Discs (cont.)

UPC	Grade	Max. RPM	Diameter	Min./Case
Roloc TSM (Metal Button) 				
048011-25765-5	A CRS	25,000	2"	50/200
048011-25764-8	A MED			
048011-25770-9	A VFN	18,000	3"	25/100
048011-25767-9	A CRS			
048011-13257-0	A CRS			
048011-25766-2	A MED			
048011-13258-7	A MED			
048011-25780-8	A VFN	A SFN		
048011-13259-4	A VFN			
048011-13260-0†	A SFN			

† Made-to-Order

Scotch-Brite™ Roloc™ SE Surface Conditioning Discs

- This coarse, tough, aggressive non-woven disc is ideal for heavy-duty deburring and finishing

UPC	Grade	Max. RPM	Diameter	Min./Case
Roloc TR (Plastic Button) 				
048011-18081-6	A CRS	25,000	2"	50/200
048011-18471-5	A MED			
048011-30005-4	A FIN	18,000	3"	25/100
048011-18082-3	A CRS			
048011-18472-2	A MED			
048011-93453-2	A FIN			

Scotch-Brite™ Roloc™ Clean and Strip Discs

- Aggressively removes paint, rust and seam sealers
- Open web construction for cool running and resistance to loading and smearing
- Faster cutting than wire brushes and wheels to increase production



UPC	Grade	Max. RPM	Size	Qty./Case
048011-14784-0	S XCS	8,000	4" x 1"	10
048011-14780-2			4" x 1" x 1/4"	

See pages 48–55 for available accessories.

Scotch-Brite™ Roloc™ Discs

Scotch-Brite™ Roloc™ Clean and Strip XT Disc

NEW!



524504

- Silicon carbide mineral
- Durable, rigid, long lasting
- Aggressive, open-web disc for cleaning welds, removing rust and paint

UPC	Grade	Max. RPM	Diameter	Min./Case
Roloc TR (Plastic Button)				
048011-30147-1	S XCS	18,000	2" x NH	60
048011-30016-0		15,000	3" x NH	40

Scotch-Brite™ Roloc™ Bristle Discs

- Efficiently clean and strip many substances from metal surfaces without damaging the work piece
- An operator can quickly and easily achieve a quality, consistent finish with light pressure



431922

UPC	Grade	Color	Max. RPM	Size	Min./Case
Roloc TR (Plastic Button)					
048011-18698-6	50	Green	30,000	1"	20/80
048011-18706-8	80	Yellow			
048011-18710-5	120	White			
048011-18730-3	50	Green	25,000	2"	10/40
048011-18732-7	80	Yellow			
048011-18733-4	120	White			
048011-18734-1	50	Green	15,000	3"	10/40
048011-18736-5	80	Yellow			
048011-18737-2	120	White			

Scotch-Brite™ Roloc™ Body Man's Bristle Disc

- Contains 3M™ Ceramic Aluminum Oxide blend abrasive grain
- Removes high loading materials fast and doesn't load
- Great for removing rubberized undercoating, seam sealer, rust and paint
- Maintains high quality product life

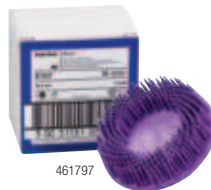

461797

UPC	Grade	Max. RPM	Diameter	Min./Case
051131-07540-5	36	30,000	1"	6/36
051131-07536-8		25,000	2"	4/24
051131-07537-5		18,000	3"	3/18

Scotch-Brite™ Roloc™ Coating Removal Discs

- Extra coarse grade silicon carbide
- Heavy duty, semi-open web used to clean rust and paint
- Color: Black



UPC	Grade	Max. RPM	Diameter	Qty./Case
048011-18364-0	S XCS	18,000	2"	60
048011-18350-3		15,000	3"	40
048011-18470-8		11,000	4"	

Scotch-Brite™ Roloc™ EXL Unitized Wheels

- Strong, efficient products for edge deburring and finishing
- Used with 3M™ Roloc™ or 3M™ Roloc™+ holder pads on a straight shaft or right-angle tool

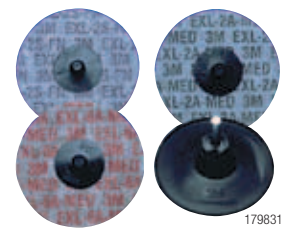

179631

UPC	Grade	Max. RPM	Size	Qty./Case
Roloc TR (Plastic Button)				
048011-17185-2	2A MED	22,100	2"	60
048011-17183-8	2S FIN			
048011-17190-6	6A MED			
048011-17192-0	8A MED	15,100	3"	40
048011-17186-9	2A MED			
048011-17184-5	2S FIN			
048011-17191-3	6A MED			
048011-17193-7	8A MED			

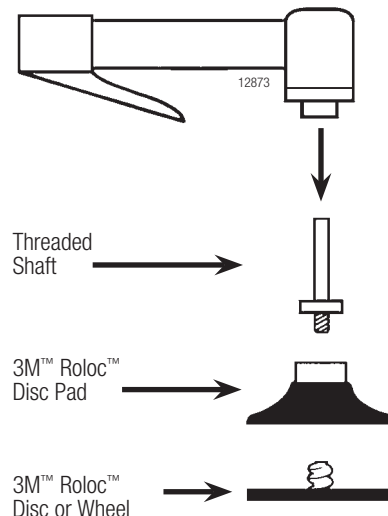

See pages 48–55 for available accessories.

Scotch-Brite™ Discs — Hook-and-Loop

Scotch-Brite™ SC Surface Conditioning Discs (Hook-and-Loop)

- Aluminum oxide
- Great general purpose surface conditioning disc
- For finishing, cleaning, and light deburring
- Attach and remove easily to 3M™ Hook-and-Loop Backup Pads
- Use with right angle and random orbital tools



UPC	Grade	Color	Max. RPM	Diameter	Min./Case
Hook-and-Loop					
048011-07458-0	A CRS	Brown	23,000	2"	50/200
048011-07459-7	A MED	Maroon			
048011-04276-3	A VFN	Blue			
048011-04127-8†	A SFN	Gray	20,000	3"	25/100
048011-04120-9	A CRS	Brown			
048011-04124-7	A MED	Maroon			
048011-04277-0	A VFN	Blue			
048011-04129-2	A SFN	Gray			
048011-04128-5	A SFN	Gray	13,000	4"	100
048011-07450-4	A CRS	Brown			
048011-07451-1	A MED	Maroon			
048011-04278-7	A VFN	Blue			
048011-04129-2	A SFN	Gray			
048011-14101-5	A CRS	Brown	13,000	4-1/2"	50
048011-27671-7	A CRS	Brown			10
048011-27672-4	A MED	Maroon			50
048011-14100-8	A MED	Maroon	13,000	4-1/2"	50
048011-14099-5	A VFN	Blue			50
048011-14102-2	A SFN	Gray			50
048011-27674-8	A CRS	Brown	10,000	5"	10
048011-00750-2	A CRS	Brown			50
048011-27675-5	A MED	Maroon			10
048011-00643-7	A MED	Maroon			50
048011-27676-2	A VFN	Blue			10
048011-04303-6	A VFN	Blue	10,000	5"	50
048011-00647-5	A SFN	Gray			50
048011-03927-5	A CRS	Brown			50
048011-03928-2	A MED	Maroon	8,000	6"	50
048011-04304-3	A VFN	Blue			

† Made-to-Order

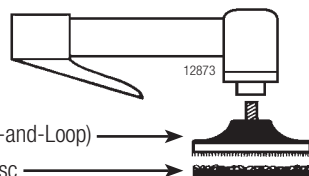

3M™ Disc Holder (Hook-and-Loop)

Surface Conditioning Disc

Scotch-Brite™ SC Surface Conditioning Discs (Hook-and-Loop) (cont.)

UPC	Grade	Color	Max. RPM	Diameter	Min./Case
Hook-and-Loop					
048011-27677-9	A CRS	Brown	6,000	7"	10
048011-00751-9					25
048011-27678-6	A MED	Maroon			10
048011-00645-1					25
048011-27679-3	A VFN	Blue			10
048011-04305-0				25	
048011-00648-2	A SFN	Gray		8"	25
048011-00752-6	A CRS	Brown			
048011-00670-3	A MED	Maroon			
048011-04306-7	A VFN	Blue		600	48"
048011-00649-9†	A SFN	Gray			
048011-13325-6†	A CRS	Brown			
048011-13100-9†	A MED	Maroon			
048011-13099-6†	A VFN	Blue	600	48"	2
048011-18385-5†	A SFN	Gray			

† Made-to-Order

Scotch-Brite™ Clean and Finish Discs (Hook-and-Loop)

- Flexible web for finishing, blending and polishing
- Conformability allows access to hard-to-reach areas



UPC	Grade	Max. RPM	Diameter	Qty./Case
048011-16001-6	A VFN	5,000	5"	100
048011-00661-1		4,000	6"	
048011-30037-5		1,900	11-1/4"	25

Scotch-Brite™ Coating Removal Discs (Hook-and-Loop)

- Extra coarse grade silicon carbide
- Made for right-angle tools from aggressive Clean & Strip web
- Non-loading design ideal for removing rust and coatings
- Mount on Hook-and-Loop Disc Pad Holders



UPC	Grade	Max. RPM	Diameter	Min./Case
Hook-and-Loop				
048011-18424-1	S XCS	12,000	4-1/2"	4/20
048011-18482-1*				40
048011-18355-8		10,000	5"	4/20
048011-18483-8*				40
048011-18358-9		6,000	7"	2/10
048011-18485-2*	20			

* Bulk

See pages 48–55 for available accessories.

Scotch-Brite™ Discs — TN Quick Change

Scotch-Brite™ Clean and Strip XT Disc, TN Quick Change

- Extra coarse grade silicon carbide
- Mounts quickly to 4-1/2" and 7" grinders
- Tough open web, ideal for weld cleaning and removing paint and coatings
- Use with TN Quick Change back up pad or fibre disc hub and face plate



148243

UPC	Grade	Max. RPM	Dia. x Thk. X AH	Min./Case
048011-33194-2	S XCS	13,300	4-1/2" x 1/2" x 5/8-11*	10
048011-33196-6		8,600	7" x 1/2" x 5/8-11*	5

* Quick Change Tinneman Nut Attachment

Scotch-Brite™ Bristle Discs

- Easily remove paint, stains, adhesives, weld burn, rust and other surface contaminants from large areas



424848

UPC	Grade	Color	Max. RPM	Diameter x AH	Qty./Case
048011-33054-9	36	Brown	12,000	4-1/2" x 5/8-11 INT	10
048011-24241-5	50	Green			
048011-24242-2	80	Yellow			
048011-24243-9	120	White			

Scotch-Brite™ Discs — Spindle Mount

Scotch-Brite™ High Strength Discs

- Aluminum oxide
- Very conformable discs, ideal for light deburring, cleaning and finishing



14463

UPC	Grade	Max. RPM	Dia. x Ctr. Hole	Min./Case
Use with Mandrel 933				
048011-05629-6†	A MED	4,000	6" x 1/4"	100
048011-27748-6	A VFN			10/40
048011-00666-6				100
Use with Mandrel 934				
048011-27745-5	A MED	4,000	6" x 1/2"	10/40
048011-04188-9				100
048011-27747-9	A VFN			10/40
048011-00665-9				100
048011-93477-8†	A MED	3,000	8" x 1/4"	50
048011-00673-4	A VFN			50
048011-27746-2	A MED		8" x 1/2"	10/20
048011-03992-3				50
048011-27749-3	A VFN	10/20		
048011-00672-7		50		

† Made-to-Order

See pages 48–55 for available accessories.

360837



Scotch-Brite™ Clean and Strip Discs

- Extra coarse grade silicon carbide
- Tough open web, ideal for weld cleaning and removing paint and coatings



51717

UPC	Grade	Max. RPM	Dia. x Ctr. Hole	Qty./Case
Use with Mandrel 934				
048011-00941-4	S XCS	6,000	4" x 1/2"	25
048011-00948-3		4,000	6" x 1/2"	15
048011-00957-5		3,000	8" x 1/2"	

Scotch-Brite™ Surface Conditioning Belts

The easiest way to a perfect finish. Choose Scotch-Brite™ Surface Conditioning Belts for cleaning, finishing, blending and deburring. The reinforced backing offers good flexibility whether working on a file belt or backstand. The non-woven material combined with abrasive grain is an ideal way to add a great finish or remove burrs without gouging or undercutting the work piece. Trust Scotch-Brite belts to deliver fantastic finishes.

Scotch-Brite™ SC Surface Conditioning Belts

- Premium Scotch-Brite™ surface conditioning non-woven web
- Designed for cleaning, finishing and light deburring

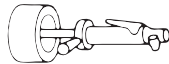
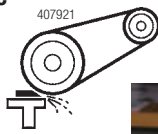

591391

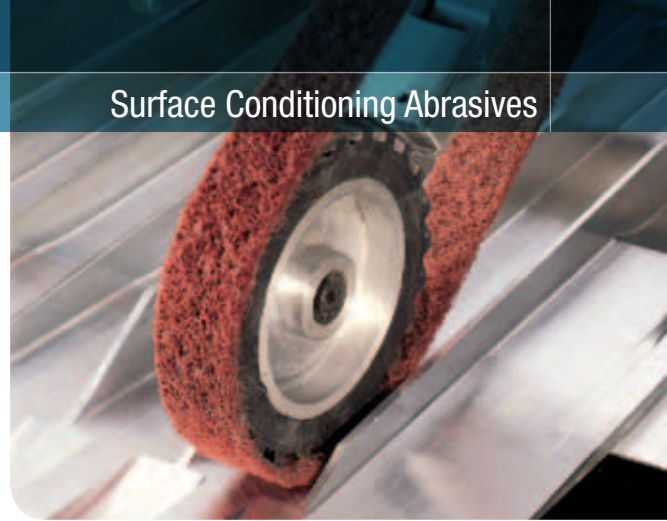

14496

UPC	Grade	Color	W x L	Qty./Case
Portable, Benchtop and Backstand				
048011-13290-7†	A CRS	Brown	1/4" x 18"	20
048011-14276-0	A MED	Maroon		
048011-13230-3†	A VFN	Blue		
048011-13132-0	A CRS	Brown	1/4" x 24"	
048011-13131-3	A MED	Maroon		
048011-13287-7	A VFN	Blue		
048011-08858-7	A CRS	Brown	1/2" x 18"	
048011-08857-0	A MED	Maroon		
048011-08856-3	A VFN	Blue		
048011-05741-5	A CRS	Brown	1/2" x 24"	
048011-03998-5	A MED	Maroon		
048011-04299-2	A VFN	Blue		
048011-13639-4	A CRS	Brown	3/4" x 18"	
048011-15899-0	A MED	Maroon		
048011-14543-3	A VFN	Blue		
048011-14278-4	A CRS	Brown	1" x 18"	10
048011-14398-9†	A MED	Maroon		
048011-17517-1†	A VFN	Blue		
048011-04189-6	A MED	Maroon	1" x 42"	
048011-04190-2	A VFN	Blue		
048011-08913-3†	A MED	Maroon		
048011-08915-7	A MED	Maroon	2" x 48"	10
048011-04295-4	A VFN	Blue		
048011-08883-9†	A CRS	Brown		
048011-00580-5	A MED	Maroon	2" x 72"	
048011-00579-9	A VFN	Blue		

† Made-to-Order

Scotch-Brite™ SC Surface Conditioning Belts (cont.)

UPC	Grade	Color	W x L	Qty./Case
Portable, Benchtop and Backstand				
048011-03999-2	A MED	Maroon	2" x 132"	5
048011-04297-8	A VFN	Blue		
048011-05022-5	A CRS	Brown	2-3/4" x 15-1/2"	10
048011-05227-4	A MED	Maroon		
048011-05820-7	A CRS	Brown	3" x 10-11/16"	
048011-05783-5	A MED	Maroon		
048011-09650-6	A VFN	Blue		
048011-14284-5†	A CRS	Brown	3" x 18"	
048011-14285-2	A MED	Maroon		
048011-14550-1	A VFN	Blue	3" x 24"	
048011-08880-8	A CRS	Brown		
048011-00583-6	A MED	Maroon		
048011-04298-5	A VFN	Blue	3" x 132"	5
048011-05023-2	A CRS	Brown		
048011-00568-3	A MED	Maroon		
048011-04289-3	A VFN	Blue	3-1/2" x 15-1/2"	10
048011-05016-4	A CRS	Brown		
048011-05228-1	A MED	Maroon		
048011-05643-2	A VFN	Blue	4" x 24"	
048011-08882-2†	A CRS	Brown		
048011-00585-0†	A MED	Maroon	4" x 132"	
048011-05018-8†	A CRS	Brown		
048011-00570-6	A MED	Maroon		
048011-04281-7	A VFN	Blue	4" x 48"	
048011-05019-5	A CRS	Brown		
048011-00590-4	A MED	Maroon		
048011-04283-1	A VFN	Blue		

† Made-to-Order

ATTENTION: Belts are available in other grades and sizes. If you need a specific belt not listed, contact your 3M Sales Specialist or 3M Authorized Distributor.

See pages 48–55 for available accessories.

Scotch-Brite™ Wheels

Get high performance and durability in a variety of cleaning, deburring, finishing and polishing applications. Used on right angle grinders and bench tools, Scotch-Brite™ Wheels produce great results on all types of metal, composites and glass.

Scotch-Brite™ Convolute Wheels

Scotch-Brite™ EXL Deburring Wheels

- Use to clean, finish, blend, deburr or polish all types of metals, composites and glass
- Silicon carbide mineral



14497

UPC	Grade	Max. RPM	Size	Qty./Case
048011-13616-5	8A MED	6,000	6" x 1/2" x 1"	4
048011-09548-6	8S FIN			
048011-05790-3	9S FIN			
048011-13617-2	8A MED			
048011-18278-0	8S MED			
048011-09549-3	8S FIN		6" x 1" x 1"	3
048011-05132-1	9S FIN			
048011-13618-9	8A MED			
048011-05133-8	9S FIN			
048011-14791-8	8S FIN			
048011-17459-4	8A MED			
048011-14629-4	8S FIN	8" x 1/2" x 3"		
048011-05791-0	9S FIN			
048011-13619-6	8A MED	4,500	8" x 1" x 3"	3
048011-18279-7	8S MED			
048011-09551-6	8S FIN			
048011-05135-2	9S FIN			
048011-13620-2	8A MED			
048011-09552-3	8S FIN		8" x 2" x 3"	2
048011-05136-9	9S FIN			
048011-05137-6	9S FIN			
048011-15641-5	8S FIN			
048011-09005-4	9S FIN			
048011-13621-9	8A MED			
048011-18281-0	8S MED			
048011-09554-7	8S FIN			
048011-05138-3	9S FIN			
048011-13622-6	8A MED	12" x 1" x 5"	1	
048011-09555-4	8S FIN			
048011-05139-0	9S FIN			
048011-13623-3	8A MED			
048011-05141-3	9S FIN			2,550

ATTENTION: Wheels are available in other grades and sizes. If you need a specific wheel not listed, contact your 3M Sales Specialist or 3M Authorized Distributor.

Scotch-Brite™ Multi-Finishing Wheels

- Produces uniform grain finishes on stainless steel and other metals
- Highly conformable



51736

UPC	Grade	Max. RPM	Dia. x W x AH	Qty./Case
048011-13170-2	2S CRS	6,000	6" x 1" x 1"	3
048011-13171-9	2S MED			
048011-13172-6	2S FIN			
048011-13176-4	2S CRS			
048011-13177-1	2S MED			
048011-13178-8	2S FIN	4,500	6" x 2" x 1"	2
048011-13183-2	2S MED			
048011-13184-9	2S FIN			
048011-13185-6	2S CRS			
048011-13186-3	2S MED			

Scotch-Brite™ Light Deburring Wheel

- Designed to provide a clean and economical system for removing fine burrs, yet resulting in a highly polished finish
- Ideal for fine deburring, polishing and finishing because of its conformability



94536

UPC	Grade	Max. RPM	Dia. x W x AH	Qty./Case		
048011-03993-0	6S FIN	6,000	6" x 1/2" x 1"	4		
048011-01662-7	7S FIN					
048011-03994-7	8S FIN					
048011-01660-3	6S FIN					
048011-01661-0	7S FIN					
048011-01675-7	8S FIN		6" x 1" x 1"	3		
048011-01664-1	7S FIN					
048011-05263-2	7S FIN					
048011-01678-8	8S FIN					
048011-01665-8	6S FIN				6" x 2" x 1"	2
048011-01666-5	7S FIN					
048011-01679-5	8S FIN					
048011-01667-2	7S FIN					
048011-01683-2	7S FIN	4,500	8" x 1/2" x 3"	4		
048011-05181-9	7S FIN					
048011-01669-6	6S FIN					
048011-01670-2	7S FIN					
048011-01666-5	7S FIN				8" x 1" x 3"	3
048011-01679-5	8S FIN					
048011-01667-2	7S FIN					
048011-01683-2	7S FIN					
048011-01675-7	8S FIN	3,600	10" x 1" x 5"	2		
048011-01683-2	7S FIN					
048011-05181-9	7S FIN					
048011-01669-6	6S FIN					
048011-01670-2	7S FIN				3,000	12" x 1/2" x 5"
048011-01686-3	8S FIN					
048011-01672-6	6S FIN					
048011-01673-3	7S FIN					
048011-01689-4	8S FIN	12" x 1" x 5"	1			
048011-01690-0	7S FIN					
048011-01672-6	6S FIN					
048011-01673-3	7S FIN					
048011-01689-4	8S FIN			12" x 2" x 5"	1	
048011-01690-0	7S FIN					
048011-17985-8	7S FIN	2,250	16" x 2" x 10"			1

See pages 48–55 for available accessories.

Scotch-Brite™ Convolute Wheels (cont.)

Scotch-Brite™ Metal Finishing Wheels

- Provides a consistent and uniform decorative brushed finish
- Use to match #3 and #4 mill finishes
- Removes minor imperfections and handling marks



UPC	Grade	Max. RPM	Size	Qty./Case
048011-05394-3†	6A CRS	6,000	6" x 1/2" x 1"	4
048011-05391-2†	5A MED			
048011-01861-4	4A CRS	6,000	6" x 1" x 1"	3
048011-01863-8	5A CRS			
048011-01866-9	6A CRS			
048011-01860-7†	4A MED			
048011-01862-1	5A MED			
048011-01865-2	6A MED			
048011-30012-2†	5A CRS			
048011-24110-4†	5A MED			
048011-01868-3	4A CRS			
048011-01888-1	5A CRS			
048011-01870-6†	6A CRS	6,000	6" x 2" x 1"	2
048011-01867-6	4A MED			
048011-01869-0	5A MED			
048011-01889-8†	6A MED			
048011-01891-1†	4A CRS			
048011-08891-4†	4A MED			
048011-09118-1†	5A CRS			
048011-14336-1†	5A CRS			
048011-16449-6†	5A MED			
048011-05414-8†	4A CRS			
048011-01872-0	5A CRS	4,500	8" x 1/2" x 3"	4
048011-01901-7	6A CRS			
048011-08926-3†	4A MED			
048011-01871-3	5A MED			
048011-01900-0†	6A MED			
048011-92896-8†	5A CRS			
048011-01875-1†	4A CRS			
048011-01904-8	5A CRS			
048011-13453-6†	6A CRS			
048011-01874-4	4A MED			
048011-01876-8	5A MED	4,500	8" x 1" x 3"	3
048011-01905-5†	6A MED			
		4,500	8" x 1" x 3"	3
		4,500	8" x 2" x 3"	2

† Made-to-Order

Scotch-Brite™ Metal Finishing Wheels (cont.)

UPC	Grade	Max. RPM	Size	Qty./Case	
048011-15608-8†	5A CRS	4,500	8" x 3" x 3"	1	
048011-13451-2†	6A CRS				
048011-13452-9†	4A MED				
048011-05395-0†	5A MED				
048011-25612-2†	6A MED				
048011-15607-1†	5A MED	3,000	12" x 1/2" x 5"	2	
048011-05398-1†	5A CRS		12" x 1" x 5"	1	
048011-15062-8†	6A CRS				
048011-01916-1	5A MED				
048011-08924-9†	6A MED				
048011-25619-1†	6A MED		12" x 1-1/4" x 5"	1	
048011-25621-4†	6A CRS				
048011-15326-1†	5A MED		3,000	12" x 1-1/2" x 5"	1
048011-09612-4†	4A CRS				
048011-13449-9	5A CRS			12" x 2" x 5"	1
048011-13448-2†	6A CRS				
048011-01921-5†	4A MED				
048011-01882-9	5A MED				
048011-14617-1†	6A MED	3,000		12" x 3" x 5"	1
048011-13446-8†	4A CRS				
048011-08902-7†	5A CRS				
048011-92916-3†	4A MED				
048011-08929-4†	5A MED		12" x 3-1/2" x 5"	1	
048011-16422-9†	5A MED				
048011-13445-1†	4A CRS		3,000	12" x 4" x 5"	1
048011-13071-2†	5A CRS				
048011-18634-4†	6A CRS				
048011-25615-3†	4A MED				
048011-05392-9†	5A MED	3,000		12" x 4" x 5"	1

† Made-to-Order

ATTENTION: Wheels are available in other grades and sizes. If you need a specific wheel not listed, contact your 3M Sales Specialist or 3M Authorized Distributor.

See pages 48–55 for available accessories.

Scotch-Brite™ Unitized Wheels

Scotch-Brite™ EXL Unitized Deburring Wheels

- Strong and efficient for deburring and polishing of all metal alloys
- Excellent in resisting smearing and minimizing heat buildup on the work piece
- Conformable wheel in a variety of densities and grades for maximum cut and durability

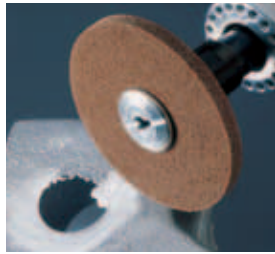

UPC	Grade	Max. RPM	Dia. x W x AH	Qty./Case
048011-15516-6	8A CRS	35,100	1" x 1/8" x 1/8"	100
048011-15517-3	6A MED		1" x 1/4" x 1/8"	
048011-13734-6	2S FIN		1" x 1" x 3/16"	
048011-13752-0	8A CRS	30,100	1" x 1" x 3/16"	50
048011-15527-2	2A MED			
048011-14063-6	6A MED			
048011-13753-7	8A MED			
048011-13713-1	2S FIN			
048011-15514-2	8A CRS	22,100	1-1/2" x 1/8" x 3/16"	80
048011-15515-9	6A MED		1-1/2" x 1/4" x 1/8"	
048011-13714-8	2S FIN		1-1/2" x 1/4" x 3/16"	
048011-14746-8				
048011-15511-1	8A CRS	16,100	2" x 1/8" x 3/16"	60
048011-15512-8	6A MED		2" x 1/4" x 1/8"	
048011-13736-0	2S FIN	22,100	2" x 1/4" x 3/16"	30
048011-15513-5	2S FIN		2" x 1/4" x 1/4"	
048011-13755-1	8A CRS	18,100	2" x 1/2" x 1/4"	40
048011-15529-6	2A MED		3" x 1/8" x 1/4"	
048011-13932-6	2S FIN	12,100	3" x 1/4" x 1/4"	40
048011-13715-5	2S FIN			
048011-15462-6	8A MED			
048011-13763-6	8A CRS	18,100	3" x 1/4" x 3/8"	40
048011-15531-9	2A MED			
048011-14067-4	6A MED	18,100	3" x 1/4" x 3/8"	40
048011-13764-3	8A MED			
048011-13716-2	2S FIN	12,100	3" x 1/4" x 3/8"	40
048011-13766-7	8A CRS			
048011-16054-2	2A MED	18,100	3" x 1/4" x 3/8"	40
048011-15118-2	6A MED			
048011-14753-6	8A MED	12,100	3" x 1/4" x 3/8"	40
048011-14750-5	2S FIN			
048011-14751-2	4A FIN	18,100	3" x 1/4" x 3/8"	40
048011-14752-9	6S FIN			

Scotch-Brite™ EXL Unitized Deburring Wheels (cont.)

UPC	Grade	Max. RPM	Dia. x W x AH	Qty./Case
048011-13767-4	8A CRS	15,100	3" x 1/2" x 1/4"	20
048011-15532-6	2A MED	10,000		
048011-13717-9	2S FIN		3" x 3/4" x 1/4"	10
048011-13718-6	2S FIN		4" x 1/4" x 1/4"	20
048011-13739-1	2S FIN	8,500	6" x 1/4" x 1/2"	8
048011-17498-3	2A MED	4,500		
048011-13741-4	2S FIN	5,000	6" x 1/4" x 3/4"	4
048011-25678-8	2A MED	4,500	6" x 1/2" x 1/2"	
048011-15534-0	2S FIN	5,000	6" x 1/2" x 5/8"	
048011-16545-5	2A MED	4,500	6" x 1/2" x 1"	2
048011-14379-8	2S FIN	5,000	6" x 1" x 1/2"	
048011-13742-1	2A MED	4,500	6" x 1" x 1"	8
048011-16544-8	2S FIN	5,000		
048011-13743-8	2S FIN	4,000	8" x 1/4" x 1/2"	4
048011-15827-3	2S FIN	4,000	8" x 1/2" x 1/2"	
048011-15844-0	2S FIN	4,000	8" x 1/2" x 3/4"	2
048011-15824-2	2S FIN	2,600	12" x 1/2" x 1-1/4"	

Scotch-Brite™ Roloc™ EXL Unitized Wheels

- Strong, efficient products for edge deburring and finishing
- Used with 3M™ Roloc™ or 3M™ Roloc™ + holder pads on a straight shaft or right-angle tool

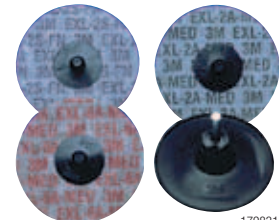

UPC	Grade	Max. RPM	Size	Qty./Case
Roloc TR (Plastic Button) 				
048011-17185-2	2A MED	22,100	2"	60
048011-17183-8	2S FIN			
048011-17190-6	6A MED			
048011-17192-0	8A MED	15,100	3"	40
048011-17186-9	2A MED			
048011-17184-5	2S FIN			
048011-17191-3	6A MED			
048011-17193-7	8A MED			

ATTENTION: Wheels are available in other grades and sizes. If you need a specific wheel not listed, contact your 3M Sales Specialist or 3M Authorized Distributor.

See pages 48–55 for available accessories.

Scotch-Brite™ Specialty Abrasives

Make tough jobs easy with these Scotch-Brite™ specialty abrasives. Unique constructions for use on contours and flat areas — on metal, wood, paint, coatings and more.

Scotch-Brite™ Flap Brush CPFB-S and CPFB-R+

- Heavy-duty brush
- Excellent for removing handling marks and surface imperfections
- Available on 1/4" shaft (CPFB-S) or 3M™ Roloc™+ attachment system (CPFB-R+)

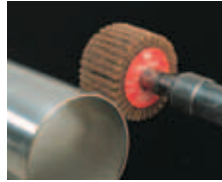

51748

UPC	Grade	Max. RPM	Dia. x W x (Shaft)	Qty./Case
CPFB-S				
048011-16622-3	A MED	12,000	2" x 1" x 1/4"	25
048011-05974-7		8,500	3" x 1-3/4" x 1/4"	10
CPFB-R+				
048011-14588-4	A MED	8,000	3" x 1-3/8"	10

Scotch-Brite™ Flap Brush CFFB-S and CFFB-R

- Ideal for decorative finishes and light deburring applications
- Available on 1/4" shaft (CFFB-S) or 3M™ Roloc™+ attachment system (CFFB-R)

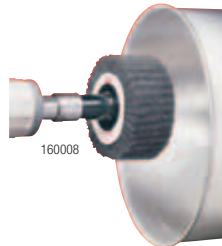

160008

UPC	Grade	Max. RPM	Dia. x W x (Shaft)	Qty./Case
CFFB-S				
048011-05975-4	A CRS	8,500	3" x 1-3/4" x 1/4"	10
048011-14781-9	S FIN			
CFFB-R				
048011-14587-7	A CRS	8,000	3" x 1-3/8"	10
048011-14783-3	S FIN			

Scotch-Brite™ Combi Wheel, Combi-S

- Made of alternating flaps of coated abrasive and Scotch-Brite™ web
- Provides aggressive cut and fine finishes



51752

UPC	Grade	Max. RPM	Dia. x W x Shaft	Qty./Case
CFFB-S				
051144-80801-4	80	8,000	3" x 1-3/4" x 1/4"	10
051144-80678-2	P120			
051144-80799-4	P180			



524406

Scotch-Brite™ CPD5-R and CPD5-S Discs

- Five discs made of a durable web, ganged together on a shaft
- Use for satin or antique finishing as well as light- to medium-duty cleaning applications
- Available on a 1/4" shaft (CPD5-S) or 3M™ Roloc™+ attachment system (CPD5-R)



159131

UPC	Grade	Max. RPM	Dia. x W x (Shaft)	Qty./Case
CPD5-S				
048011-14593-8	A MED	10,000	3" x 1-1/4" x 1/4"	10
048011-14779-6		8,000	4" x 1-1/4" x 1/4"	
CPD5-R				
048011-14594-5	A MED	10,000	3" x 1-1/4"	10
048011-14590-7		8,000	4" x 1-1/4"	

Scotch-Brite™ Clean and Strip Discs D2

- Rigid and aggressive web is excellent for cleaning welds, rust, paint and coatings



51747

UPC	Grade	Max. RPM	Dia. x W x Shaft	Qty./Case
048011-14780-2	S XCS	8,000	4" x 1" x 1/4"	10
048011-14784-0			4" x 1"	8

See pages 48–55 for available accessories.

Scotch-Brite™ Specialty Abrasives (cont.)

Scotch-Brite™ Stars

- Perfect for polishing internal diameters of pipe and tubing
- Conformable Scotch-Brite™ construction assures complete cleaning and polishing of all surfaces



UPC	Grade	Max. RPM	Diameter	Qty./Case
048011-13370-6	A CRS	24,000	1-1/2"	100
048011-13800-8	A VFN		2"	
048011-13371-3	A CRS			
048011-13803-9	A VFN	18,000	3"	50
048011-13372-0	A CRS		4"	
048011-13802-2	A VFN			
048011-13373-7	A CRS			
048011-13804-6	A VFN			

Scotch-Brite™ Cross Buffs

NEW!

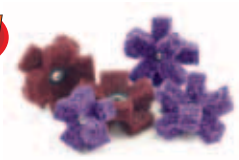

- Versatile and flexible shape ideal for light deburring, cleaning, finishing and polishing internal diameters and hard to reach areas
- Available in A VFN for high luster finishes or A MED for more aggressive applications requiring increased durability

UPC	Grade	Max. RPM	Diameter	Qty./Case
048011-64299-4	A MED	20,000	1" x 3/8" x 2 PLY x 8-32	50
048011-64446-2	A VFN		1-1/2" x 3/8" x 2 PLY x 8-32	
048011-64305-2	A MED			1-1/2" x 1/2" x 2 PLY x 8-32
048011-64526-1	A VFN			
048011-64447-9	A VFN	12,000	2" x 1/2" x 2 PLY x 8-32	25
048011-64312-0	A MED		2" x 1/2" x 2 PLY x 8-32	
048011-64433-2	A VFN			

See pages 48–55 for available accessories.

524413

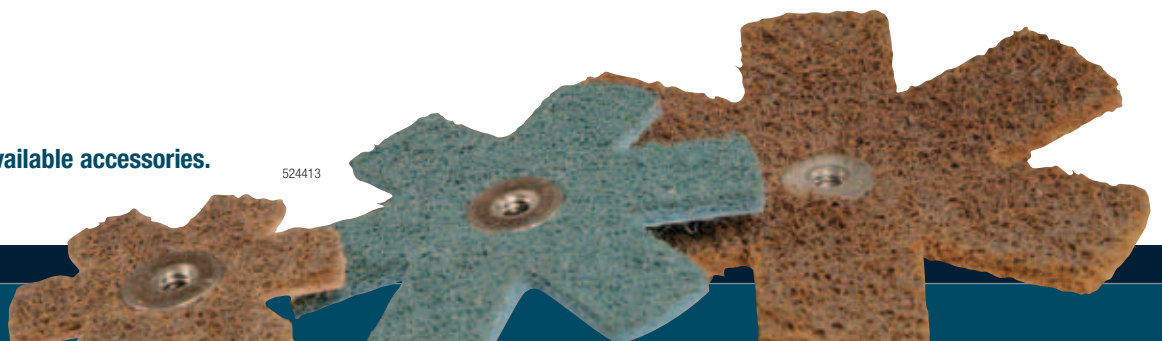

Scotch-Brite™ Hand Pad Selection Guide

	Blending	Finishing	Deburring	Cleaning
Good	Multi-Flex	Multi-Flex	—	Multi-Flex
Better	7446, 7447	7440, 7447, 7448	—	7447
Best	7440, 8447	7446, 8447	7440	8447

Less Aggressive/Finer Finish

More Aggressive/Coarser Finish

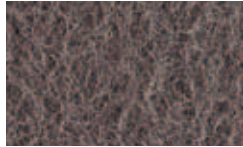

Scotch-Brite™ Ultra Fine Hand Pad 7448 (Gray)

- Ultra fine consistent finishes on metals, woods, plastics and composites
- Provides similar performance as steel wool grade 00

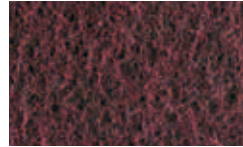

Scotch-Brite™ General Purpose Hand Pad 7447 (Maroon)

- Standard for surface conditioning worldwide
- Clean, blend, finish, and deburr faster, easier and with better results than conventional abrasives
- Provides similar performance as steel wool grade 1

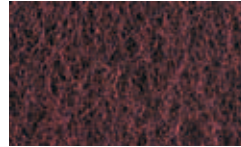

Scotch-Brite™ Production Hand Pad 8447 (Maroon)

- High cut for paint preparation, blending, and scuffing
- Long life performance on aluminum, stainless steel, plastics, wood and fiberglass
- Provides similar performance as steel wool grade 2

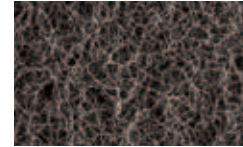

Scotch-Brite™ Blending Hand Pad 7446 (Gray)

- Specially designed for hand blending and finishing stainless steel
- Mineral coarseness blends surface scratches on many metals, wood and synthetic surfaces
- Provides similar performance as steel wool grade 3



Scotch-Brite™ Heavy Duty Hand Pad 7440 (Tan)

- Most durable and aggressive pad for quick stock removal
- Cuts fast to remove contaminants and oxides in the most demanding cleaning and finishing applications
- Provides similar performance as steel wool grade 4

Scotch-Brite™ Hand Pads

Scotch-Brite™ Hand Pads

- Excellent products for hand finishing and cleaning of woods, metals and composites
- Ideal for wood finishing, paint prep and general cleaning



UPC	Grade	Color	Cat. No.	W x L	Qty./Case
048011-04050-9	A MED	Tan	7440	6" x 9"	40
048011-04051-6	S MED	Gray	7446		
048011-04029-5	A VFN	Maroon	7447		60
048011-04229-9			7447 Bulk		
048011-24037-4			8447		
048011-04028-8	S ULF	Light Gray	7448		

See pages 48–55 for available accessories.

Scotch-Brite™ Roll and Sheet Roll Selection Guide

	Blending	Finishing	Deburring	Cleaning
Good	Multi-Flex	Multi-Flex	—	Multi-Flex
Better	Clean and Finish	Clean and Finish	—	Clean and Finish
Best	Cut and Polish	Production Clean and Finish	Cut and Polish	Production Clean and Finish

Scotch-Brite™ Multi-Flex Sheet Rolls

- Highly conformable non-woven web roll is perforated to easily tear into sixty 8" x 4" sheets
- Excellent sharpness and conformability for cleaning and finishing surfaces by hand



51768

UPC	Grade	Color	W x L	Qty./Case
051131-07521-4	A VFN	Maroon	8" x 20'	2
051131-07522-1	S ULF	Light Gray		

Scotch-Brite™ Cut and Polish Rolls

- A unique and aggressive material for cleaning and finishing
- Sturdy, long lasting web material is great for heavy industrial cleaning and light deburring applications
- Works well for stropping and other bench applications



14432

UPC	Grade	W x L	Qty./Case
048011-04085-1	A MED	1" x 30'	2
048011-05206-9		2" x 30'	
048011-05207-6		4" x 30'	

Scotch-Brite™ Production Clean and Finish Rolls

- Precision web/mineral configuration for most uniform general purpose finishing in roll form
- Excellent for critical finishes and long life



601735

UPC	Grade	Color	W x L	Qty./Case
048011-28175-9†	A VFN	Maroon	4" x 30'	3
048011-28176-6†			6" x 30'	2

† Made-to-Order

Scotch-Brite™ Clean and Finish Rolls

- Highly conformable Scotch-Brite™ web can be cut to desired length for hand sanding or oscillating sanders



51764

UPC	Grade	W x L	Min./Case
048011-00291-0†	A FIN	2" x 30'	6
048011-00260-6	A VFN		
048011-00261-3	A VFN	3" x 30'	4
048011-00264-4	A MED	4" x 30'	3
048011-00265-1	A FIN		
048011-00266-8	A VFN		
048011-00270-5	A VFN		
048011-00263-7	F SFN		
048011-00267-5	F SFN		
048011-00268-2	S ULF		
048011-00262-0	TALC	6" x 30'	2
048011-00274-3	A MED		
048011-00275-0	A FIN		
048011-00276-7	A VFN	12" x 30'	1
048011-00284-2	A VFN		
048011-00254-5	TALC		

† Made-to-Order



14399

See pages 48–55 for available accessories.



3M™ Bonded Wheels

Durable and fast cutting wheels for your toughest grinding and cutting applications. Run with 3M™ Grinders or 3M™ Cut-Off Wheel Tools for optimal performance. For use on all metals. **DO NOT USE ON TOOLS WITHOUT GUARDS.**

		Product	Mineral	Type
All Metals	Better	General Purpose	Aluminum Oxide	T27
	Best	3M™ Green Corps™	3M™ Ceramic abrasive grain	T27
				T27 Flexible
				T27 Cut and Grind
				T28 Depressed Center

3M™ Bonded Type 27 Wheels

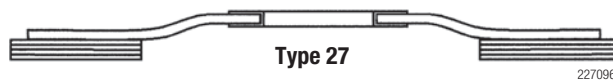

3M™ General Purpose Type 27 Wheel

- Aluminum Oxide Mineral
- Durable wheel provides exceptionally long life at a value price
- Excellent, economical choice for general purpose grinding on steel

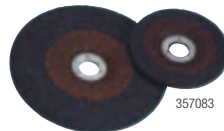

UPC	Grade	Max. RPM	Dia. x Thk. x AH	Qty./Case
051135-92312-2	24	13,300	4-1/2" x 1/4" x 7/8"	40
051135-92314-6			4-1/2" x 1/4" x 5/8-11 INT	
051135-92313-9	8,500	8,500	7" x 1/4" x 7/8"	20
051135-92315-3			7" x 1/4" x 5/8-11 INT	

For safe applications using cut-off wheels, refer to ANSI B-7.1 for details. ALWAYS use appropriate wheel guards. Refer to ANSI B-186.1 for guarding requirements.

3M™ Green Corps™ Type 27 Flexible Grinding Wheel

- 3M™ Ceramic abrasive grain
- Smooth running wheels produce less noise and vibration when grinding
- Can be used on a wide variety of metals
- Must be used on a tool with a guard



UPC	Grade	Max. RPM	Dia. x Thk. x AH	Qty./Case
051111-50440-6	36	13,300	4-1/2" x 1/8" x 7/8"	20/40
051111-50442-0	46			
051111-50443-7	60			
051111-50444-4	80	8,500	7" x 1/8" x 7/8"	20/20
051111-50445-1	36			
051111-50446-8	46			
051111-50447-5	60			

3M™ Green Corps™ Type 27 Depressed Center Wheel

- 3M™ Ceramic abrasive grain
- Provides exceptionally fast cut and long life
- Use with right angle grinders with a guard

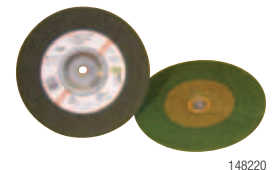

UPC	Grade	Max. RPM	Dia. x Thk. x AH	Qty./Case
051111-61010-7	24	15,000	4" x 1/4" x 3/8"	60
051111-55991-8	24	13,300	4-1/2" x 1/4" x 7/8"	40
051111-55992-5	36		4-1/2" x 1/4" x 5/8-11 INT	
051111-55960-4	24			
051111-55961-1	36	8,500	7" x 1/4" x 7/8"	20
051111-55989-5	24		7" x 1/4" x 5/8-11 INT	
051111-55990-1	36			
051111-55958-1	24	6,600	9" x 1/4" x 7/8"	
051111-55959-8	36		9" x 1/4" x 5/8-11 INT	
051111-55987-1	24			
051111-55956-7	24			

3M™ Green Corps™ Type 27 Cutting and Grinding Wheel

- 3M™ Ceramic abrasive grain
- Safe to grind outer face and cut with edge of same wheel



UPC	Grade	Max. RPM	Dia. x Thk. x AH	Qty./Case
051135-92316-0	36	13,300	4-1/2" x 1/8" x 7/8"	40
051135-92318-4			4-1/2" x 1/8" x 5/8-11 INT	
051135-92317-7	8,500	8,500	7" x 1/8" x 7/8"	20
051135-92319-1			7" x 1/8" x 5/8-11 INT	

See pages 48-55 for available accessories.

3M™ Bonded Type 28 Wheels

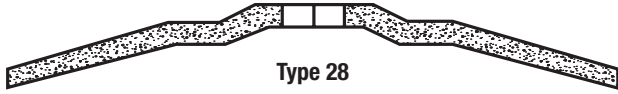

NEW!

3M™ Green Corps™ T-28 Depressed Center Wheel

- Made with 3M™ Ceramic abrasive grain for fast cut rates and long life
- T28 shape works well when grinding at lower tool angles (15–25 degrees)
- Great for weld removal, grinding in tight areas and other MRO applications



UPC	Grade	Max. RPM	Dia. x Thk. x AH	Qty./Case
051141-28327-2	24	8,500	7" x 1/4" x 5/8 INT	10

3M™ Cut-Off Wheels

	Product	Mineral	Type
All Metals	Better General Purpose	Aluminum Oxide	T1
	Best 3M™ Green Corps™ High Performance	3M™ Ceramic abrasive grain	T1
			T1

3M™ General Purpose Cut-Off Wheels

- Value priced wheel provides fast cut and long life
- Best on carbon steel
- Must be used with ANSI-approved flanges for Type 1 cut-off wheels
- Do not use on tools without guards



UPC	Max. RPM	Dia. x W x AH	Min./Case
051141-20447-5	10,200	6" x .045" x 7/8"	50/100
051141-20448-2	21,000	4" x 1/32" x 3/8"	
051141-20449-9		4" x 1/16" x 3/8"	

3M™ Cut-Off Wheels (cont.)

3M™ High Performance Cut-Off Wheel

- 3M™ Ceramic abrasive grain
- Provides faster cut and longer life on various substrates including stainless steel
- Must be used with ANSI-approved flanges for Type 1 cut-off wheels
- Do not use on tools without guards

UPC	Max. RPM	Dia. x W x AH	Min./Case
051141-20349-2	10,200	6" x .045" x 7/8"	50/200

3M™ Green Corps™ Cut-Off Wheels

- 3M™ Ceramic abrasive grain
- Provides high cut rates and long life on various substrates, including fiberglass, stainless steel and carbon steel
- Must be used with ANSI-approved flanges for Type 1 cut-off wheels
- Do not use on tools without guards



UPC	Max. RPM	Dia. x W x AH	Qty./Case
051144-83487-7	42,000	2" x 1/16" x 1/4"	50/50
051144-82238-6	35,000	3" x 1/32" x 1/4"	
051131-01989-8	35,000	3" x 1/32" x 3/8"	5 wheels/pack 10 packs/case
051131-01985-0			50/50
051131-01990-4	28,000	3" x 1/16" x 3/8"	5 wheels/pack 10 packs/case
051131-01986-7			50/50
051144-83488-4	21,000	4" x 1/16" x 3/8"	50/50
051144-88755-2	26,250	4" x 1/32" x 1/4"	50/50
051131-01994-2	26,250	4" x 1/32" x 3/8"	
051141-20275-4	13,300	4-1/2" x 3/64" x 7/8"	50/200
051141-20276-1	12,200	4-59/64" x 3/64" x 7/8"	

For safe applications using cut-off wheels, refer to ANSI B-7.1 for details. ALWAYS use appropriate wheel guards. Refer to ANSI B-186.1 for guarding requirements.

See pages 48–55 for available accessories.

Kits and Packs

Scotch-Brite™ Surface Conditioning Disc Pack 9145S, 915S, 917S

- Contains a variety of grades of non-woven surface conditioning discs
- Used for cleaning, finishing, blending and deburring applications
- Includes 9145 disc pad holder



UPC (048011-)	Max RPM	Catalog No.	Size	Min./Case
14105-3	13,000	9145S	4-1/2"	1/5
08713-9	10,000	915S	5"	
04270-1	6,000	917S	7"	

Scotch-Brite™ Surface Conditioning Disc Pack 920S

- Contains a variety of grades of 2" and 3" non-woven surface conditioning discs
- Used for cleaning, finishing, blending and deburring applications
- Includes 922 and 923 disc pad holder



UPC (048011-)	Size	Min./Case
18253-7	2" and 3"	1/5

Scotch-Brite™ Hand Pad Trial Pack 961S

- Contains 1 each of the following:
 - Scrubbing Sponge 74
 - Light Duty Pad 6448
 - Heavy Duty Pad 7440
 - Light Duty Cleansing Pad 7445
 - Blending Pad 7446
 - General Purpose Pad 7447
 - Ultra Fine Pad 7448
 - Production Pad 8447
 - Twist-Lok™ Pad Holder 961



UPC (048011-)	Size	Min./Case
17144-9	6" x 9"	5

3M™ Roloc™ Disc Pack 982S and 983S

- Includes Roloc™ Surface Conditioning Discs, 3M™ Coated Abrasive Discs and 3M™ Roloc™ Disc Pad

UPC (051144-)	Catalog No.	Size	Min./Case
82899-9	982S	2"	1/5
82900-2	983S	3"	

3M™ Roloc™ Bristle Disc Pack 983BS

- Contains a variety of grades of 3M™ Roloc™ Bristle Discs 3" diameter x 5/8" trim
- Includes a disc pad holder



UPC (048011-)	Size	Min./Case
18697-9	3"	1/5

3M™ Roloc™ Disc Pack 985S

- Contains a variety of grades of 2" and 3" non-woven 3M™ Roloc™ Surface Conditioning Discs
- Also contains 2" and 3" disc pads and 1/4" threaded shaft

UPC (048011-)	Size	Min./Case
18254-4	2" and 3"	1/5

Scotch-Brite™ Unitized Wheel Pack 990S

- Contains several Scotch-Brite™ external Unitized Wheels 1" x 1" x 3/16" and 3" x 1/4" x 3/8" in a variety of densities and grades
- Also includes 936 and 990 mandrels

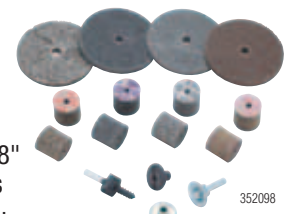

UPC (048011-)	Size	Min./Case
18245-2	1" x 1" x 3/16" and 3" x 1/4" x 3/8"	1/5

3M™ NTN Maintenance and Repair Kit

- Variety of easy mounting (no mounting tools required) coated and surface conditioning 4-1/2" discs for use on right angle tools
- Contains 1 each of the following:
 - 3M™ TN Disc Pad
 - Scotch-Brite™ Light Grinding and Blending Disc, TN, Super Duty
 - Scotch-Brite™ Clean and Strip XT Disc, TN, S XCS
 - 3M™ Fibre Disc 785C, TN, grade 36
 - 3M™ Flap Disc 747D, TN, grade 36



UPC (048011-)	Size	Min./Case
33013-6	4-1/2"	1/5





For appropriate product maximum operating speed, see kit package safety insert.

Accessories

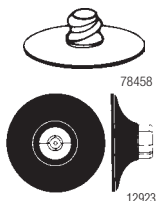

Product Name	UPC	Qty./Case	For Use With	Size/Description	Max RPM
3M™ Fibre Disc Accessories					
3M™ Disc Pad Hub†  51694	051141-28442-2 NEW!	10	Short shaft tools†	2-1/2" Diameter; 3/8–24 metal insert	N/A
	051144-45205-7		3M™ Disc Pad Face Plates (all sizes)†	2-1/2" Diameter; 5/8–11 metal insert	
	051144-88743-9		3M™ Disc Pad Face Plates (all sizes, tool shaft length 1/2" or less)†		
	051144-45190-6		3M™ Disc Pad Face Plates (7" or larger)†	4-1/2" Diameter; 5/8–11 metal insert	
3M™ Low Profile Disc Pad Hub†  712406	051141-28476-7 NEW!		3M™ Disc Pad Face Plates (all sizes, tool shaft length 1/2" or less)†	2-1/2" Diameter; 5/8–11 metal insert	N/A
3M™ Disc Pad Face Plates  51695	051144-13325-3	10	Fibre Discs	4-1/2" Diameter; Smooth; Medium – Gray	13,300
	051144-14270-5			4-1/2" Diameter; Smooth; Hard – Black	
	051141-28443-9 NEW!			4-1/2" Diameter; Ribbed; Extra Hard – Red	
	051144-81734-4			5" Diameter; Ribbed; Medium – Gray	12,000
	051144-81733-7			5" Diameter; Ribbed; Hard – Black	
	051144-81732-0			5" Diameter; Ribbed; Extra Hard – Red	
	051144-80516-7			7" Diameter; Ribbed; Medium – Gray	8,600
	051144-80515-0			7" Diameter; Ribbed; Hard – Black	
	051144-80514-3			7" Diameter; Ribbed; Extra Hard – Red	
3M™ Fibre Disc Backup Pad and Retainer Nut 	051141-28530-6 NEW!	1	4" Fibre Discs with 5/8" Center Hole	4" Diameter; 3/8–24 INT	15,000
3M™ TN Quick Change Disc Backup Pad  352092	051111-56573-5	5	4-1/2" TN Discs	4-1/2" x 5/8–11 INT	13,300
3M™ Disc Retainer Nuts  51696	051111 -51047-6	10	3M™ Disc Pad Face Plates and Disc Pad Hubs	5/16" Depth; 5/8–11 Thread	N/A
	051144 -05622-4			3/8" Depth; 5/8–11 Thread	
	051144 -05621-7			1/2" Depth; 5/8–11 Thread	
	051144 -05620-0			5/8" Depth; 5/8–11 Thread	
3M™ Disc Holder Adapter No. 9  12896	048011-22971-3	10	Converts grinders with M10–1.25, M10–1.5, or 3/8–24 external threaded shaft to a 5/8–11 external threaded shaft	M10–1.25 INT	N/A
	048011-22972-0			M10–1.50 INT	
	048011-22970-6			3/8–24 INT	

† Also for use with Scotch-Brite Light Grinding and Blending Discs.

Accessories

Product Name	UPC	Qty./Case	For Use With	Size/Description	Max RPM
3M™ Flap Discs/Bonded Wheels Accessories					
Flap Disc/ Grinding Wheel Adapter Nut 	051144-88765-1	1 Pair/5 Pairs	Secures 4-1/2" diameter flap discs or 4-1/2" grinding wheels to right angle tool with a 5/8-11 threaded shaft	5/8-11 Thread Size	N/A
Flap Disc Holder 	051144-88769-9	1	Backup plate for 7" diameter flap discs or 8" diameter type 27 grinding wheels	4" Diameter; 5/8-11 Thread Size	N/A
3M™ Green Corps™ Flexible Grinding Disc 	051111-51046	5/100	Backup plate for 4-1/2" center hole flexible grinding wheel	7/8" Center Hole Diameter; 3-3/8" Diameter; Clear	N/A
	051111-51045		Backup plate for 7" center hole flexible grinding wheel	7/8" Center Hole Diameter; 4-5/8" Diameter; Clear	
3M™ Roloc™ Disc Accessories					
3M™ Roloc™ TR Disc Pads   4" Diameter; Cool Running	051144-45101-2	5	3M™ Roloc™ TR Discs	1" Diameter; Medium; 1/4-20 INT	30,000
	051144-45099-2			1-1/2" Diameter; Medium; 1/4-20 INT	
	051144-45100-5			1-1/2" Diameter; Hard; 1/4-20 INT	
	051144-45095-4			2" Diameter; Medium; 1/4-20 INT	25,000
	051144-45096-1			2" Diameter; Hard; 1/4-20 INT	
	051144-45092-3			3" Diameter; Medium; 1/4-20 INT	18,000
	051144-45091-6			3" Diameter; Hard; 1/4-20 INT	20,000
	051144-45179-1			4" Diameter; Medium; 1/4-20 INT	12,000
	051111-56479-0 NEW!			4" Diameter; Cool Running; 3/8-24 INT	15,000
	051141-28474-3 NEW!			4" Diameter; Hard; 3/8-24 INT	12,000
	051141-28475-0 NEW!			4" Diameter; Extra Hard; 3/8-24 INT	
	051141-28473-6 NEW!			4" Diameter; Cool Running; 5/8-11 INT	15,000
	051144-83242-2			4" Diameter; Medium; 5/8-11 INT	12,000
	051144-83489-1			4" Diameter; Hard; 5/8-11 INT	
	051144-83980-3			4" Diameter; Extra Hard; 5/8-11 INT	

Accessories

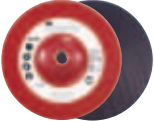
Product Name	UPC	Qty./Case	For Use With	Size/Description	Max RPM
3M™ Roloc™ Disc Accessories (cont.)					
3M™ Roloc™ TS or TSM Disc Pads 	051144-77729-7	5	3M™ Roloc™ TSM Discs and "screw on" abrasive discs	1-1/2"; Medium	30,000
	051144-77728-0			1-1/2"; Hard	
	051144-14211-8			2"; Medium	25,000
	051144-14212-5			2"; Hard	
	051144-14215-6			3"; Medium	18,000
	051144-14216-3			3"; Hard	20,000
3M™ Roloc™ Cool Running Disc Pads 	051111-56479-0 NEW!	5	3M™ Roloc™ TR Discs	4"; 3/8–24 INT	—
	051141-28473-6 NEW!			4"; 5/8–11 INT	
3M™ Roloc™ TP Disc Pads	051144-14201-9	5	3M™ Roloc™ TP Discs	3"; Medium; 1/4–20 INT	18,000
	051144-14202-6			3"; Hard; 1/4–20 INT	20,000
1/4" Threaded Shaft 	051144-45102-9	10/50	Used on 3M™ Roloc™ Disc Pads with 1/4–20 INT	1/4" x 1/4–20 Thread	N/A
3M™ Roloc™ + Holder 	048011-15408-4	5	3M™ Roloc™ Unitized Wheels, Roloc™+ Products, Brush and Disc Accessories	1" Diameter x 1/4" Shaft Diameter	25,000
Scotch-Brite™ Light Grinding and Blending Disc Accessories					
3M™ Disc Pad Face Plates* 	051144-14270-5	10	Light Grinding and Blending Discs	4-1/2" Diameter; Smooth; Hard – Black	13,300
	051141-28443-9 NEW!			4-1/2" Diameter; Ribbed; Extra Hard – Red	
	051144-81733-7			5" Diameter; Ribbed; Hard – Black	12,000
	051144-81732-0			5" Diameter; Ribbed; Extra Hard – Red	
	051144-80515-0			7" Diameter; Ribbed; Hard – Black	8,600
	051144-80514-3			7" Diameter; Ribbed; Extra Hard – Red	
3M™ Hook-and-Loop Disc Pad Holder 	051141-20245-7	1	Scotch-Brite™ Light Grinding and Blending Disc Accessories	7" x 7/8" Center Post; 5/8–11 INT	8,500

* Must be used with 3M™ Disc Pad Hubs. See page 48.

Accessories







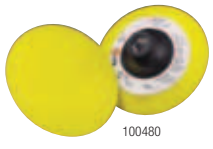
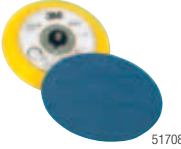

Product Name	UPC	Qty./Case	For Use With	Size/Description	Max RPM
Scotch-Brite™ Disc Accessories					
3M™ Hook-and-Loop Disc Pad Holders  Disc Pad Holder No. 922 and 923	048011-07494-8	10	Scotch-Brite™ Surface Conditioning Discs	2" (1/4" shank); Catalog No. 922	23,000
	048011-04132-2			3" (1/4" shank); Catalog No. 923	20,000
 Disc Pad Holder No. 924	048011-07492-4	5		4" (1/4" shank); Catalog No. 924	13,000
	 Disc Pad Holder No. 914	048011-05674-6		4" x 1/8" x 3/8" 5/8–11 INT; Catalog No. 914	
 Disc Pad Holder No. 9145 and 915		048011-14111-4		4-1/2" x 5/8–11 INT; Catalog No. 9145	
	048011-05680-7	5" x 5/8–11 INT; Catalog No. 915			
 Disc Pad Holder No. 905	048011-09448-9	1		5" x 5/16–24 EXT; Catalog No. 905	10,000
 Disc Pad Holder No. 917	048011-09450-2			7" x 5/8–11 INT; Catalog No. 917	6,000
 Disc Pad Holder No. 947TH	051141-20279-2			7" x 1" x 5/8–11 INT; Catalog No. 947TH	
 Disc Pad Holder No. 918	048011-09451-9			8" x 5/16" x 3/8" 5/8–11 INT; Catalog No. 918	
3M™ TN Quick Change Disc Backup Pad 	051111-56573-5	5	4-1/2" TN Discs	4-1/2" x 5/8–11 INT	13,300
Mandrels††   Mandrel No. 933 1/4" Shaft Dia. Mandrel No. 934 1/2" Shaft Dia.	048011-13968-5	5	Furnished complete with washers to fit available wheel and disc sizes††	Catalog No. 933; 2" x 1/4" x 1"	14,000
	 Mandrel No. 933 or 934 Disc	048011-04021-9		1	Catalog No. 934; 3-1/16" x 1/4" x 2-1/2"

†† Also for use with Unitized Wheels.

Accessories

Product Name	UPC	Qty./Case	For Use With	Size/Description	Max RPM	Max OPM
Scotch-Brite™ Disc Accessories (cont.)						
3M™ Wheel Adapter Kits 	051141-28419-4 NEW!	1	3M™ Inline Sanders; 4", 6" 8" Scotch-Brite™ Surface Conditioning Discs; Wheels with 1/2"-1" center holes	Part No. 28419; 1/2-20 EXT	See MOS of abrasive disc or wheel	N/A
	051144-45038-1 NEW!	1		Part No. 45038; 5/8-11 EXT		N/A
	048011-04019-6 NEW!	1		Part No. 300		N/A
3M™ Hookit™ Disc Accessories						
3M™ Hookit™ Disc Pad 	051131-05755-5	10	Scotch-Brite™ Coating Removal Discs	5" x 3/8" x 5/16-24 EXT	12,000	12,000
	051144-85096-9			5" x 5/8" x 5/8-11 INT	12,000	N/A
	051144-13625-4			5" x 3/4" x 5/16-24 EXT	10,000	12,000
	051144-85105-8			5 x 3/4" x 5/8-11 INT	12,000	N/A
	051144-13627-8	1		7" x 1" x 5/8-11 INT	6,000	N/A
3M™ Stikit™ Disc Accessories						
3M™ Stikit™ Disc Pads 	051131-05545-2	10	3M™ Stikit™ Discs	5" x 11/16" 5/16-24 EXT; Low Profile Finishing	12,000	12,000
	051131-05546-9			6" x 11/16" 5/16-24 EXT; Low Profile Finishing	10,000	12,000
	051131-05555-1			5" x 3/8" 5/16-24 EXT; Low Profile	12,000	12,000
	051131-05556-8			6" x 3/8" x 5/16-24 EXT; Low Profile	10,000	12,000
	051144-05575-3	1/10		5" x 3/4" x 5/16-24	10,000	12,000
	051144-05576-0			6" x 3/4" x 5/16-24		
	051144-05579-1	1		8" x 5/8-11 INT	3,000	N/A
	051111-55813-3	5		5" x 1/2" 5/8-11 INT	12,000	N/A
	051141-20351-5	10		5" x 3/8" x 5/16-24 EXT; Red Foam; Low Profile	12,000	12,000
	051141-20354-6			6" x 3/8" x 5/16-24 EXT; Red Foam; Low Profile	12,000	12,000
	051144-81821-1	10		5" x 3/4" 5/16-24 EXT	10,000	12,000
	051144-82189-1			5" x 3/4" 5/8-11 INT	12,000	N/A
	051144-88736-1			5" x 3/8" 5/16-24 EXT	10,000	12,000



Accessories

Product Name	UPC	Qty./Case	For Use With	Size/Description	Max RPM
3M™ PSA Disc Accessories					
PSA Disc Holder 	051144-45070-1	10	Any air or electric grinding tool that accommodates a 1/4" shank; Supports 248D/348D PSA disc	2" Diameter	15,000
	051144-05510-4			3" Diameter	10,000
	051144-45068-8	5		5" Diameter	6,000
Unitized Wheel Accessories					
Mandrels 	048011-04018-9	5	Scotch-Brite™ Unitized Wheels	Mandrel No. 936 ; 2-1/16" x 1/4" x 3/4"	22,200
	048011-15012-3			Mandrel No. 990 with 3" wheel; 1-3/4" x 1/4" x 1"	18,200
Convolute Wheel Accessories					
Flange Adapter Kit No. 5 	048011-16859-3	1 Set	6" Wheels; Telescoping wheel adapters 1" and 1/2" wide to reduce 1" wheel cores to fit 1/2", 5/8", 3/4", or 7/8" shafts; Must be used with side flanges	1" x 1/2" x 1/2"	N/A
	048011-16860-9			1" x 1" x 1/2"	
Flap Wheel Accessories					
Wheel Adapter Kit No. 3 	051144-45035-0	1	Two arbor hole (plug type) adapters for 6" and 8" diameter flap wheels	1" OD x 1/2" ID	N/A
	051144-45034-3			1" OD x 5/8" ID	
	051144-45033-6			1" OD x 3/4" ID	
	051144-45032-9			1" OD x 7/8" ID	
Wheel Adapter Kit No. 81A 	051144-45081-7	1	For T84 Flap Wheels	1/4" x 1/4"-20 INT	N/A
Star Accessories					
Mandrel No. 944 	048011-13928-9	1	Scotch-Brite™ Stars for cleaning and polishing internal diameters of pipe and tubing	1/4" x 1/4"-20 EXT	25,100
Cross Buff Accessories					
3M™ Mandrel 	048011-14307-8	1	Scotch-Brite™ Cross Buffs for cleaning and polishing internal diameters of pipe and tubing	1/4" x 8-32 EXT	Dependent upon abrasive product used
Cartridge Roll Accessories					
3M™ Mandrels 	051144-45119-7	25	Screw-type mandrels for securing cartridge rolls to tool	1/8" x 1" x 1/4"	24,000 (1/2" and smaller cartridge roll diameter); 16,000 (5/8"-3/4" cartridge roll diameter)
	051144-45117-3			3/16" x 1" x 1/4"	
	051144-45118-0			3/16" x 1-1/2" x 1/4"	

Accessories

Product Name	UPC	Qty./Case	For Use With	Size/Description	Max RPM
Cross and Square Pad Accessories					
	051144-14308-5	1	Used for holding square and cross pads with 1/4–20 and 8–32 internal threaded inserts	1/4" x 1/4–20 EXT	Dependent upon abrasive product used
	051144-14307-8			1/4" x 8–32 EXT	
	051141-28385-2	5		1/4" x 3–48 EXT	
Band and Belt Accessories					
	051144-77717-4	1	Slotted wheels for use with bands	1" x 1" x 1/4"	18,000
	051144-77718-1			1-1/2" x 1" x 1/4"	14,000
	051144-77720-4			2" x 1" x 1/4"	12,000
	051144-77721-1			2" x 2" x 1/4"	6,000
	051144-77722-8			3" x 3" x 5/8–INT	
	051141-28348-7			5" x 3-1/2" 5/8" Arbor Hole	3,500
	051141-28349-4			3-1/4" x 3" 5/8" Arbor Hole	
	051144-45159-3	1	Use with bands when creating fine finishes	1/4" x 1/2" x 1/8"	23,000
	051144-45156-2			1/2" x 1/2" x 1/4"	30,000
	051144-45153-1			1/2" x 1" x 1/4"	15,000
	051144-45152-4			1/2" x 1-1/2" x 1/4"	
	051144-45145-6			3/4" x 1" x 1/4"	17,000
	051144-45144-9			3/4" x 1-1/2" x 1/4"	10,000
	051144-45139-5			1" x 1" x 1/4"	18,000
	051144-45138-8			1" x 1-1/2" x 1/4"	10,000
	051144-45132-6			1-1/2" x 1" x 1/4"	14,000
	051144-45131-9			1-1/2" x 1-1/2" x 1/4"	10,000
	051144-45130-2			1-1/2" x 2" x 1/4"	8,000
	051144-45129-6			2" x 1" x 1/4"	11,000
	051144-45127-2			2" x 2" x 1/4"	6,000
	051144-45124-1			3" x 3" x 3/8"	3,000
	051144-45123-4			3" x 3" x 1/2"	

Accessories

Product Name	UPC	Qty./Case	For Use With	Size/Description	Max RPM
Utility Cloth Sheet and Roll Accessories					
Forked Spindle  51772	051144-45121-0	10	For attaching utility cloth strips	1/4" x 3"	N/A
Scotch-Brite™ Hand Pad Accessories					
Scotch-Brite™ Pad Holder No. 961  51766	048011-09493-4	10	Scotch-Brite™ Hand Pads; Provides increased leverage and eliminates "finger" marks	3-1/2" x 4-3/4"	N/A
Scotch-Brite™ Roll Accessories					
Mini Mandrel No. 935  14475	048011-04020-2	5	Scotch-Brite™ Strips to clean and polish inner diameters and other tight areas	2-7/8" x 1/4"	14,000

Abrasive Grade Comparison Guide

Ind'l Mesh-ANSI	FEPA "P"	Micron (μ)	Scotch-Brite™ Grade*
12			
	P12		
	P16		
16			
	P20		
20			
	P24		
24			
	P30		
30			
36			
	P36		
40			
	P40		
50			
	P50		
60			
	P60		
	P80		
80		180	
	P100	150	
100			Extra Coarse
	P120	120	
120			Coarse
	P150	100	
150			Medium
180		80	
220			
	P220		
	P240	60	
240			Fine
	P280		
	P320	50	
280		40	
	P360		
320			Very Fine
	P400	35	
	P500	30	
360			
	P600		
400			
	P800	22	
		20	
500			
	P1000	18	
600			Super Fine
	P1200		
		15	
	P1500		
800		12	
	P2000	10	
1000			Ultra Fine
		9	
	P2500		
1200			
		5	
			Microfine
1500		3	
2000		1	

Scotch-Brite™ Product Guide

Density Number (prefix to mineral)

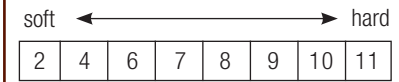

Mineral Abbreviations (prefix to grade)

- A—Aluminum Oxide mineral
- S—Silicon Carbide mineral
- T—Talc mineral

Grade Abbreviations

- ULF—Ultra Fine
- SFN—Super Fine
- VFN—Very Fine
- FIN—Fine
- MED—Medium
- CRS—Coarse
- XCS—Extra Coarse

Example:

2S MED = Soft Density,
Silicon Carbide Mineral,
Medium Grade

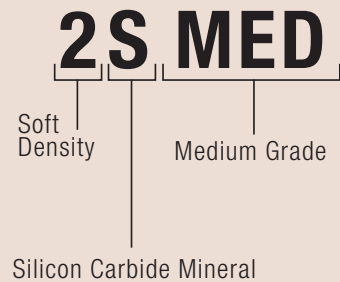

Measurement Conversions:

- 1 inch = 25.4 millimeters
- 1 millimeter = 0.039370 inches
- 1 micron (μ) = 0.000039 inches

ANSI—American National Standards Institute

FEPA—Federation of European Producers of Abrasives Products

*Scotch-Brite™ Surface Conditioning Grade (Generates finish approximately equivalent to indicated coated abrasive grade.)

Complete solutions. Commitment to Innovation and Quality.



Complete solutions. It's what you've come to expect from 3M, the leading supplier for welding industries. For over 100 years, 3M has been a proven leader, providing advanced technology and innovative solutions for increased productivity, enhanced efficiency and improved manufacturing processes.

This commitment to innovation continues with ongoing new product introductions focused on the complete metalworking experience. Today, 3M Welding Products encompass a broad spectrum of solution-specific products from personal safety to abrasives and high-strength adhesives. 3M presents a growing portfolio with each addition to this line of advanced solutions designed for all metalworking processes from start to finish.





THREE EASY WAYS TO CONTACT US FOR ALL 3M INDUSTRIAL PRODUCTS:

3M can provide additional products and accessories to meet your needs. Please contact us in any of the following ways that you prefer:

- 1 Contact your local 3M authorized distributor directly. For information on a 3M distributor or sales representative in your area, contact us at the numbers below:

For the contiguous 48 United States:

Call **1-866-279-1288**

Fax **1-877-369-2923**

- 2 E-mail us at 3MIndustrial@mmm.com

- 3 For additional 3M product information call **1-800-3M Helps** or visit us at www.3M.com

Prices subject to change without notice.

Important Notice to Purchaser

Safety Information: Always read and follow all safety information included with the product. Do not exceed maximum operating RPM's. Use guards provided with machine. Follow safety operation procedures posted in work areas.

Product Use: All statements, technical information and recommendations contained in this document are based upon tests or experience that 3M believes are reliable. However, many factors beyond 3M's control can effect the use and performance of a 3M product in a particular application, including the conditions under which the product is used and the time and environments conditions in which the product is expected to perform. Since these factors are uniquely within the user's knowledge and control, it is essential that the user evaluate the 3M product to determine whether it is fit for a particular purpose and suitable for the user's method of application.

Warranty and Limited Remedy: Unless stated otherwise in 3M's product literature, packaging inserts or product packaging for individual products, 3M warrants that each 3M product meets the applicable specifications at the time 3M ships the product. Individual products may have additional or different warranties as stated on product literature, package inserts or product packages. 3M MAKES NO OTHER WARRANTIES, EXPRESS OR IMPLIED, INCLUDING, BUT NOT LIMITED TO, ANY IMPLIED WARRANTY OF MERCHANTABILITY OR FITNESS FOR A PARTICULAR PURPOSE OR ANY IMPLIED WARRANTY ARISING OUT OF A COURSE OF DEALING, CUSTOM OR USAGE OF TRADE. User is responsible for determining whether the 3M product is fit for a particular purpose and suitable for user's application. If the 3M product is defective within the warranty period, your exclusive remedy and 3M's and seller's sole obligation will be at 3M's option, to replace the product or refund the purchase price.

Limitation of Liability: Except where prohibited by law, 3M and seller will not be liable for any loss or damage arising from the 3M product, whether direct, indirect, special, incidental, or consequential, regardless of the legal theory asserted, including warranty, contract, negligence, or strict liability.



Abrasive Systems Division
3M Center, Building 223-6S-03
St. Paul, MN 55144-1000
1-866-279-1235
www.3M.com/abrasives

3M, Cool Flow, Classic, Cubitron, CUNO, DX, E-A-R, E-A-Rsoft, EARflex, EARform, EPX, Green Corps, Hookit, Lexa, Neons, One Touch, Optime, Peltor, Push-Ins, Roloc, Safety-Walk, Scotch, Scotch-Brite, Scotch-Seal, Scotch-Weld, Scotchblok, Scotchpar, Scotchpro, Speedglas, Stikit, Super 77, Tartan, Trizact, UltraFit, VHB, Virtua, Wetordry, X.Sport and Yellow Neon are all trademarks of 3M.

Please Recycle. Printed in U.S.A. © 3M 2011. All rights reserved. 61-5002-8284-5 Bolger 11080470