

## Features

- 3.0V to 5.5V Operating Range
- Lowest Power in Its Class
- Advanced Low-voltage, Zero-power, Electrically Erasable Programmable Logic Device
- “Zero” Standby Power (25 $\mu$ A Maximum) (Input Transition Detection)
- Low-voltage Equivalent of Atmel ATF22V10CZ
- Ideal for Battery Powered Systems
- CMOS- and TTL-compatible Inputs and Outputs
- Inputs are 5V Tolerant
- Latch Feature Hold Inputs to Previous Logic States
- EE Technology
  - Reprogrammable
  - 100% Tested
- High-reliability CMOS Process
  - 20-year Data Retention
  - 10,000 Erase/Write Cycles
  - 2,000V ESD Protection
  - 200mA Latch-up Immunity
- Commercial and Industrial Temperature Ranges
- Dual Inline and Surface Mount Standard Pinouts
- Green Package Options (Pb/Halide-free/RoHS Compliant) Available

## 1. Description

The Atmel<sup>®</sup> ATF22LV10CZ/CQZ is a high-performance CMOS (electrically erasable) programmable logic device (PLD) that utilizes The Atmel proven electrically erasable Flash memory technology and provides 25ns speed with standby current of 25 $\mu$ A maximum. All speed ranges are specified over the 3.0V to 5.5V range for industrial and commercial temperature ranges.

The ATF22LV10CZ/CQZ provides a low-voltage and edge-sensing “zero” power CMOS PLD solution with “zero” standby power (5 $\mu$ A typical). The ATF22LV10CZ/CQZ powers down automatically to the zero power mode through The Atmel patented Input Transition Detection (ITD) circuitry when the device is idle. The ATF22LV10CZ/CQZ is capable of operating at supply voltages down to 3.0V. Pin “keeper” circuits on input and output pins hold pins to their previous logic levels when idle, which eliminate static power consumed by pull-up resistors. The “CQZ” combines this low high-frequency ICC of the “Q” design with the “Z” feature.

The ATF22LV10CZ/CQZ macrocell incorporates a variable product term architecture. Each output is allocated from 8 to 16 product terms which allows highly complex logic functions to be realized. Two additional product terms are included to provide synchronous reset and asynchronous reset. These additional product terms are common to all ten registers and are automatically cleared upon power-up. Register Preload simplifies testing. A security fuse prevents unauthorized copying of programmed fuse patterns.



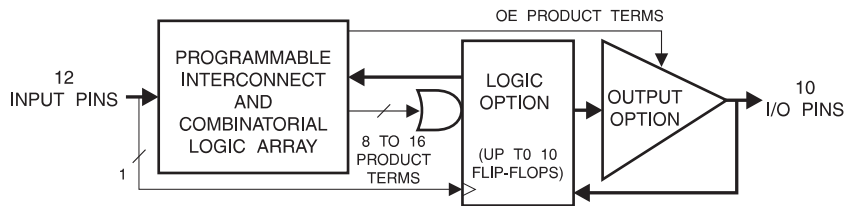
**High-performance  
Electrically  
Erasable  
Programmable  
Logic Device**

**Atmel ATF22LV10CZ  
Atmel ATF22LV10CQZ**

**ATF22LV10CZ is  
Not Recommended for New  
Design. Replaced by  
ATF22LV10CQZ.**



**Figure 1-1. Block Diagram**

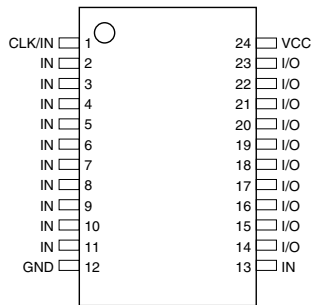


## 2. Pin Configurations

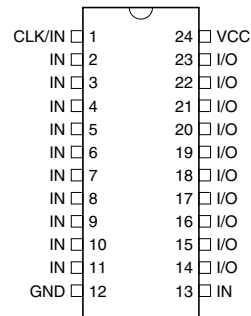
**Table 2-1. Pin Configurations (All Pinouts Top View)**

| Pin Name | Function               |
|----------|------------------------|
| CLK      | Clock                  |
| IN       | Logic Inputs           |
| I/O      | Bi-directional Buffers |
| GND      | Ground                 |
| VCC      | (3 to 5.5V) Supply     |

**Figure 2-1. TSSOP**

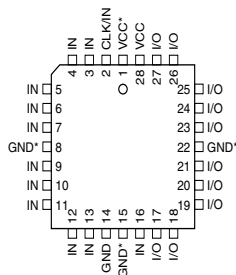


**Figure 2-2. DIP/SOIC**



Note: TSSOP is the smallest package of SPLD offering

**Figure 2-3. PLCC**



Note: For PLCC, pins 1, 8, 15, and 22 can be left unconnected. For superior performance, connect VCC to pin 1 and GND to pins 8, 15, and 22

## 3. Absolute Maximum Ratings\*

|   |                                |
|---|--------------------------------|
| Temperature under Bias .....  | -40°C to +85°C                 |
| Storage Temperature.....  | -65°C to +150°C                |
| Voltage on Any Pin with<br>Respect to Ground.....                           | -2.0V to +7.0V <sup>(1)</sup>  |
| Voltage on Input Pins<br>with Respect to Ground<br>during Programming ..... | -2.0V to +14.0V <sup>(1)</sup> |
| Programming Voltage with<br>Respect to Ground.....                          | -2.0V to +14.0V <sup>(1)</sup> |

\*NOTICE: Stresses beyond those listed under “Absolute Maximum Ratings” may cause permanent damage to the device. This is a stress rating only and functional operation of the device at these or any other conditions beyond those indicated in the operational sections of this specification is not implied. Exposure to absolute maximum rating conditions for extended periods may affect device reliability.

Note: 1. Minimum voltage is -0.6V DC, which may undershoot to -2.0V for pulses of less than 20ns. Maximum output pin voltage is  $V_{CC} + 0.75V$  DC, which may overshoot to 7.0V for pulses of less than 20ns.

## 4. DC and AC Operating Conditions

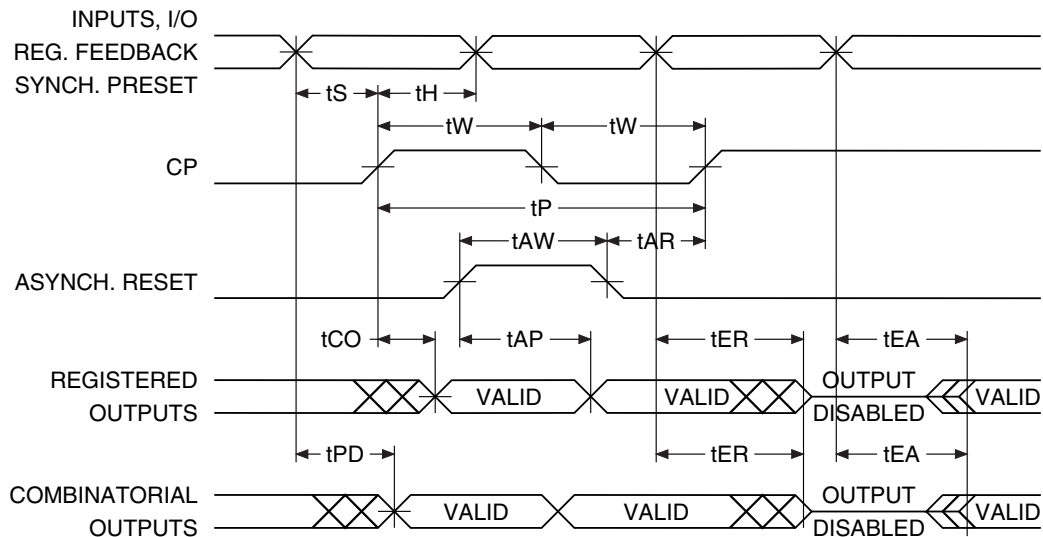
|                                 | Commercial  | Industrial   |
|---------------------------------|-------------|--------------|
| Operating Temperature (Ambient) | 0-C - 70-C  | -40-C - 85-C |
| $V_{CC}$ Power Supply           | 3.0V - 5.5V | 3.0V - 5.5V  |

## 4.1 DC Characteristics

| Symbol         | Parameter                         | Condition <sup>(2)</sup>  | Min                  | Typ  | Max             | Units         |               |
|----------------|-----------------------------------|---|----------------------|------|-----------------|---------------|---------------|
| $I_{IL}$       | Input or I/O Low Leakage Current  | $0 \leq V_{IN} \leq V_{IL} \text{ (Max)}$   |                      |      | -10.0           | $\mu\text{A}$ |               |
| $I_{IH}$       | Input or I/O High Leakage Current | $(V_{CC} - 0.2)V \leq V_{IN} \leq V_{CC}$   |                      |      | 10.0            | $\mu\text{A}$ |               |
| $I_{CC}$       | Clocked Power Supply Current      | $V_{CC} = \text{Max}$<br>Outputs Open,<br>$f = 15\text{MHz}$                                  | CZ-25 <sup>(3)</sup> | Com. | 50.0            | 85.0          | $\text{mA}$   |
|                |                                   |   | CZ-25 <sup>(3)</sup> | Ind. | 55.0            | 90.0          | $\text{mA}$   |
|                |                                   |   | CQZ-30               | Com. | 18.0            | 50.0          | $\text{mA}$   |
|                |                                   |   | CQZ-30               | Ind. | 19.0            | 60.0          | $\text{mA}$   |
| $I_{SB}$       | Power Supply Current, Standby     | $V_{CC} = \text{Max}$<br>$V_{IN} = \text{Max}$<br>Outputs Open                                | CZ-25 <sup>(3)</sup> | Com. | 3.0             | 25.0          | $\mu\text{A}$ |
|                |                                   |   | CZ-25 <sup>(3)</sup> | Ind. | 4.0             | 50.0          | $\mu\text{A}$ |
|                |                                   |   | CQZ-30               | Com. | 3.0             | 25.0          | $\mu\text{A}$ |
|                |                                   |   | CQZ-30               | Ind. | 4.0             | 50.0          | $\mu\text{A}$ |
| $I_{OS}^{(1)}$ | Output Short Circuit Current      | $V_{OUT} = 0.5V$  |                      |      | -130.0          | $\text{mA}$   |               |
| $V_{IL}$       | Input Low Voltage                 |   | -0.5                 |      | 0.8             | V             |               |
| $V_{IH}$       | Input High Voltage                |   | 2.0                  |      | $V_{CC} + 0.75$ | V             |               |
| $V_{OL}$       | Output Low Voltage                | $V_{IN} = V_{IH} \text{ or } V_{IL}$<br>$V_{CC} = \text{Min}$ ,<br>$I_{OL} = 16\text{mA}$     |                      |      | 0.5             | V             |               |
| $V_{OH}$       | Output High Voltage               | $V_{IN} = V_{IH} \text{ or } V_{IL}$<br>$V_{CCIO} = \text{Min}$ ,<br>$I_{OH} = -2.0\text{mA}$ | 2.4                  |      |                 | V             |               |
| $V_{OH}$       | Output High Voltage               | $I_{OH} = -100 \mu\text{A}$   | $V_{CC} - 0.2V$      |      |                 | V             |               |

- Note:
1. Not more than one output at a time should be shorted. Duration of short circuit test should not exceed 30 sec
  2. For DC characterization, the test condition of  $V_{CC} = \text{Max}$  corresponds to 3.6V
  3. Shaded devices are becoming obsolete and replaced with CQZ-30 part in green package offering

## 4.2 AC Waveforms



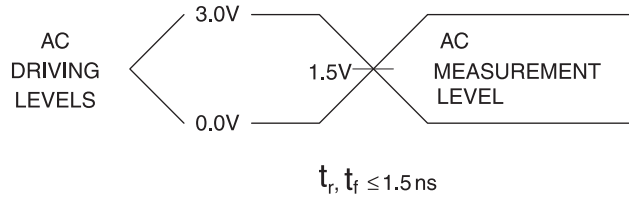
## 4.3 AC Characteristics<sup>(1)</sup>

| Symbol    | Parameter                                      | -25 <sup>(2)</sup> |      | -30  |      | Units |
|-----------|--|--------------------|------|------|------|-------|
|           |  | Min                | Max  | Min  | Max  |       |
| $t_{PD}$  | Input or Feedback to Non-registered Output     | 3.0                | 25.0 | 10.0 | 30.0 | ns    |
| $t_{CF}$  | Clock to Feedback                              |                    | 13.0 | 10.0 | 15.0 | ns    |
| $t_{CO}$  | Clock to Output                                | 2.0                | 15.0 | 4.0  | 20.0 | ns    |
| $t_S$     | Input or Feedback Setup Time                   | 15.0               |      | 18.0 |      | ns    |
| $t_H$     | Input Hold Time                                | 0                  |      | 0    |      | ns    |
| $t_P$     | Clock Period                                   | 25.0               |      | 30.0 |      | ns    |
| $t_W$     | Clock Width                                    | 12.5               |      | 15.0 |      | ns    |
| $f_{MAX}$ | External Feedback $1/(t_S + t_{CO})$           | 33.3               |      |      | 25.0 | MHz   |
|           | Internal Feedback $1/(t_S + t_{CF})$           | 35.7               |      |      | 30.0 | MHz   |
|           | No Feedback $1/(t_P)$                          | 40.0               |      |      | 33.3 | MHz   |
| $t_{EA}$  | Input to Output Enable                         | 3.0                | 25.0 | 10.0 | 30.0 | ns    |
| $t_{ER}$  | Input to Output Disable                        | 3.0                | 25.0 | 10.0 | 30.0 | ns    |
| $t_{AP}$  | Input or I/O to Asynchronous Reset of Register | 3.0                | 25.0 | 10.0 | 3.0  | ns    |
| $t_{SP}$  | Setup Time, Synchronous Preset                 | 15.0               |      | 20.0 |      | ns    |
| $t_{AW}$  | Asynchronous Reset Width                       | 25.0               |      | 30.0 |      | ns    |
| $t_{AR}$  | Asynchronous Reset Recovery Time               | 25.0               |      | 30.0 |      | ns    |
| $t_{SPR}$ | Synchronous Preset to Clock Recovery Time      | 15.0               |      | 20.0 |      | ns    |

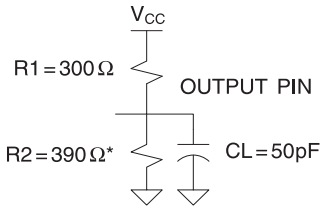
- Note:
1. See ordering information for valid part numbers
  2. Shaded products are becoming obsolete

## 4.4 Input Test Waveforms

### 4.4.1 Input Test Waveforms and Measurement Levels



### 4.4.2 Output Test Loads



Note: Similar competitor devices are specified with slightly different loads. These load differences may affect output signals' delay and slew rate. Atmel devices are tested with sufficient margins to meet compatible device specification conditions

## 4.5 Pin Capacitance

Table 4-1. Pin Capacitance ( $f = 1 \text{ MHz}$ ,  $T = 25^\circ \text{C}^{(1)}$ )

|           | Typ | Max | Units | Conditions     |
|-----------|-----|-----|-------|----------------|
| $C_{IN}$  | 5   | 8   | pF    | $V_{IN} = 0V$  |
| $C_{I/O}$ | 6   | 8   | pF    | $V_{OUT} = 0V$ |

Note: 1. Typical values for nominal supply voltage. This parameter is only sampled and is not 100% tested

## 4.6 Power-up Reset

The registers in the Atmel® ATF22LV10CZ/CQZ are designed to reset during power-up. At a point delayed slightly from  $V_{CC}$  crossing  $V_{RST}$ , all registers will be reset to the low state. The output state will depend on the polarity of the buffer.

This feature is critical for state machine initialization. However, due to the asynchronous nature of reset and the uncertainty of how  $V_{CC}$  actually rises in the system, the following conditions are required:

1. The  $V_{CC}$  rise must be monotonic and start below 0.7V
2. The clock must remain stable during  $T_{PR}$
3. After  $T_{PR}$ , all input and feedback setup times must be met before driving the clock pin high

## 4.7 Preload of Register Outputs

The ATF22LV10CZ/CQZ's registers are provided with circuitry to allow loading of each register with either a high or a low. This feature will simplify testing since any state can be forced into the registers to control test sequencing. A JEDEC file with preload is generated when a source file with vectors is compiled. Once downloaded, the JEDEC file preload sequence will be done automatically by most of the approved programmers after the programming.

## 5. Electronic Signature Word

There are 64-bits of programmable memory that are always available to the user, even if the device is secured. These bits can be used for user-specific data.

## 6. Security Fuse Usage

A single fuse is provided to prevent unauthorized copying of the Atmel® ATF22LV10CZ/CQZ fuse patterns. Once programmed, fuse verify and preload are inhibited. However, the 64-bit User Signature remains accessible.

The security fuse should be programmed last, as its effect is immediate.

## 7. Programming/Erasing

Programming/erasing is performed using standard PLD programmers. See CMOS PLD Programming Hardware and Software Support for information on software/ programming.

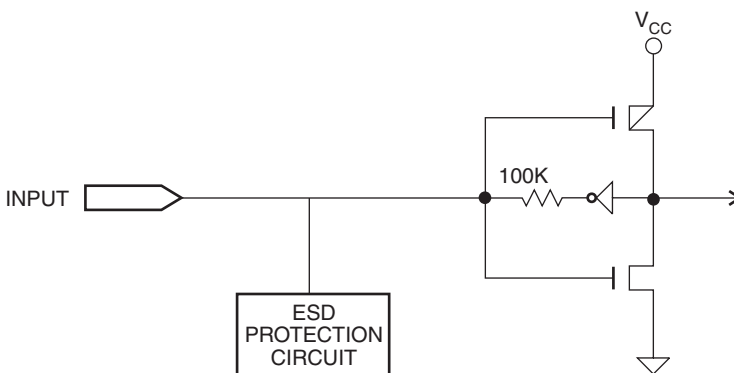
**Table 7-1.** Programming/Erasing

| Parameter | Description            | Typ | Max  | Units |
|-----------|------------------------|-----|------|-------|
| $T_{PR}$  | Power-up Reset Time    | 600 | 1000 | ns    |
| $V_{RST}$ | Power-up Reset Voltage | 2.3 | 2.7  | V     |

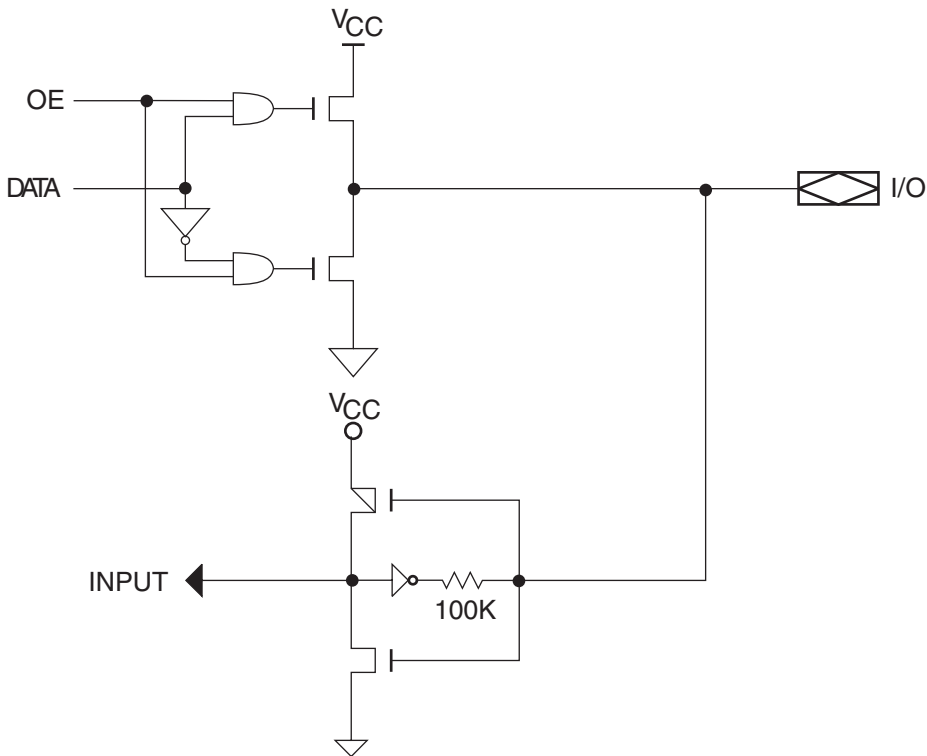
## 8. Input and I/O Pin Keepers

All ATF22LV10CZ/CQZ family members have internal input and I/O pin-keeper circuits. Therefore, whenever inputs or I/Os are not being driven externally, they will maintain their last driven state. This ensures that all logic array inputs and device outputs are at known states. These are relatively weak active circuits that can be easily overridden by TTL-compatible drivers (see input and I/O diagrams below).

**Figure 8-1.** Input Diagram



**Figure 8-2.** I/O Diagram



## 9. Functional Logic Diagram Description

The Functional Logic Diagram describes the Atmel® ATF22LV10CZ/CQZ architecture.

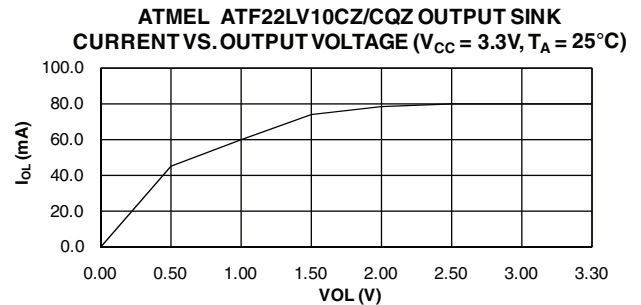
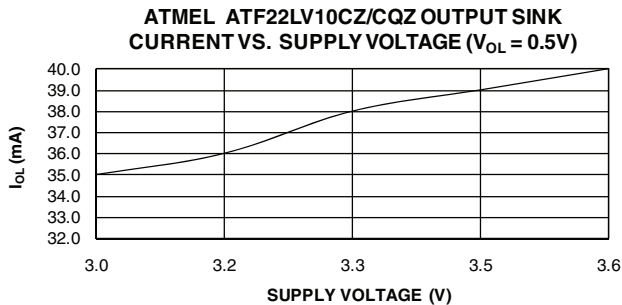
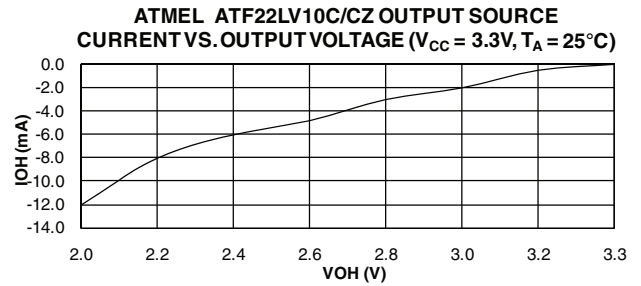
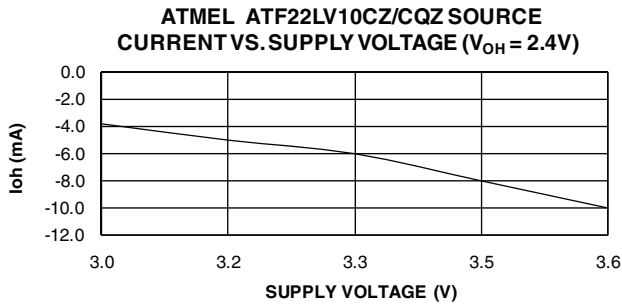
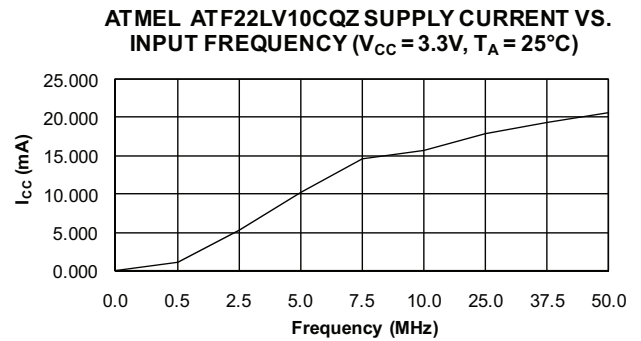
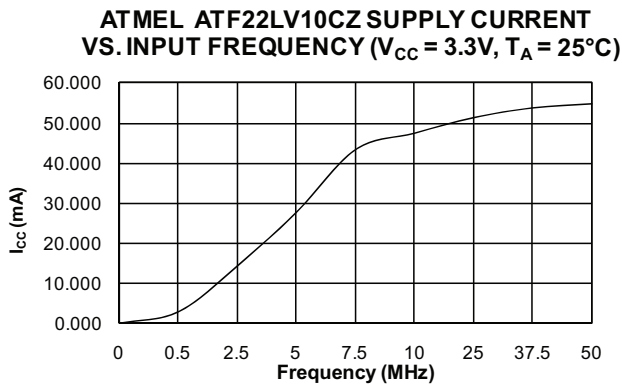
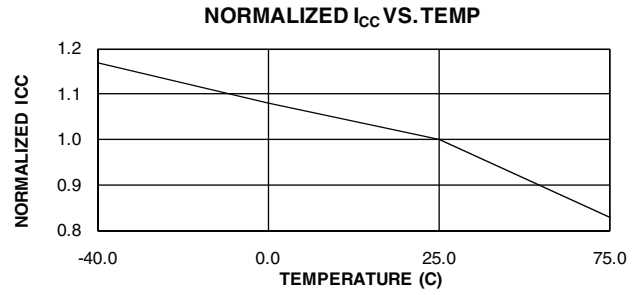
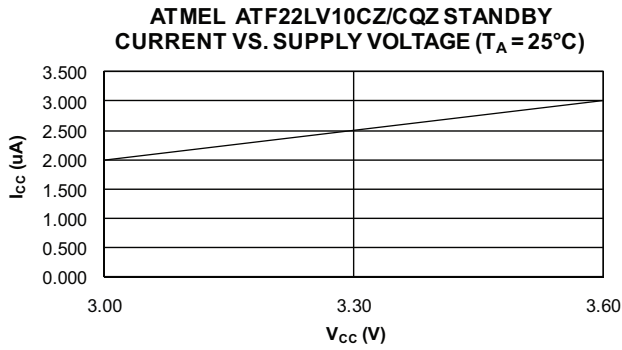
The ATF22LV10CZ/CQZ has 12 inputs and 10 I/O macrocells. Each macrocell can be configured into one of four output configurations: active high/low or registered/combinatorial. The universal architecture of the ATF22LV10CZ/CQZ can be programmed to emulate most 24-pin PAL devices.

Unused product terms are automatically disabled by the compiler to decrease power consumption. A security fuse, when programmed, protects the contents of the ATF22LV10CZ/CQZ. Eight bytes (64-fuses) of User Signature are accessible to the user for purposes such as storing project name, part number, revision or date. The User Signature is accessible regardless of the state of the security fuse.

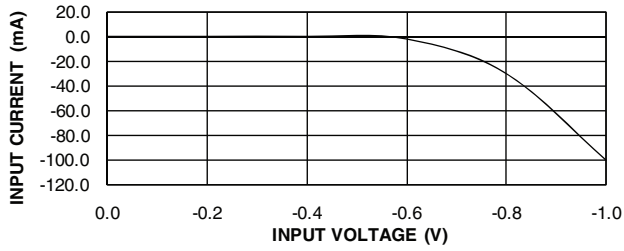


**Figure 9-1.** Functional Logic Diagram Atmel ATF22LV10CZ/CQZ

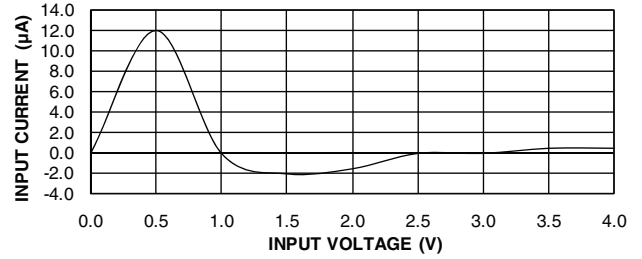




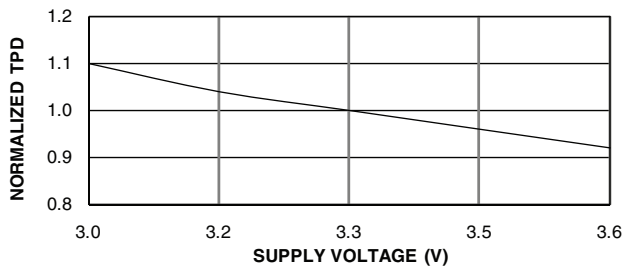
**ATMEL ATF22LV10CZ/CQZ INPUT CLAMP CURRENT VS. INPUT VOLTAGE ( $V_{CC} = 3.3V, T_A = 25^\circ C$ )**



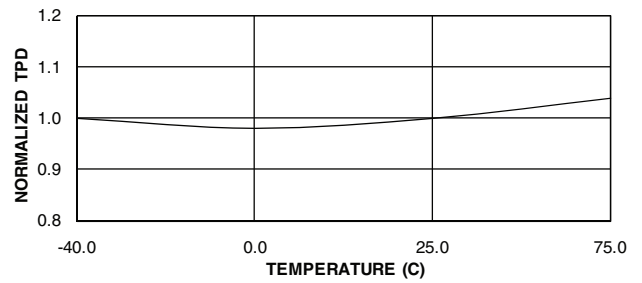
**ATMEL ATF22LV10CZ/CQZ INPUT CURRENT VS. INPUT VOLTAGE ( $V_{CC} = 3.3V, T_A = 25^\circ C$ )**



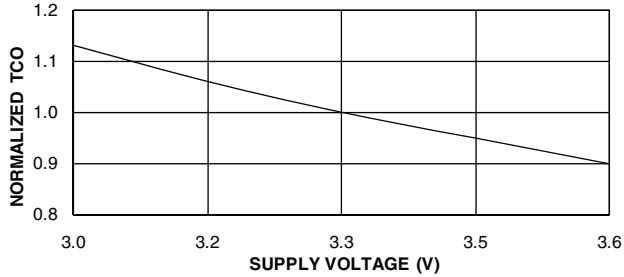
**NORMALIZED  $T_{PD}$  VS.  $V_{CC}$**



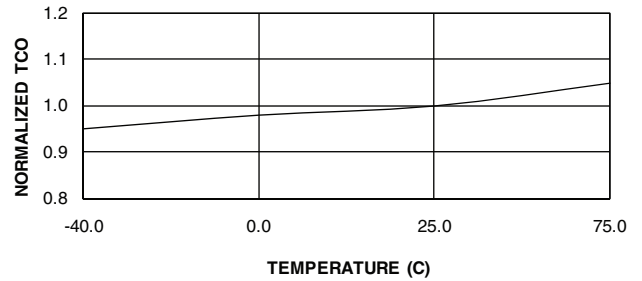
**NORMALIZED  $T_{PD}$  VS. TEMP**



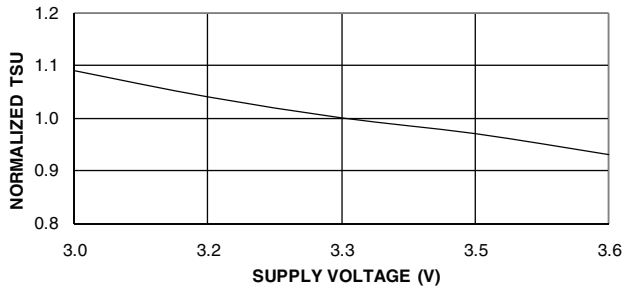
**NORMALIZED  $T_{CO}$  VS.  $V_{CC}$**



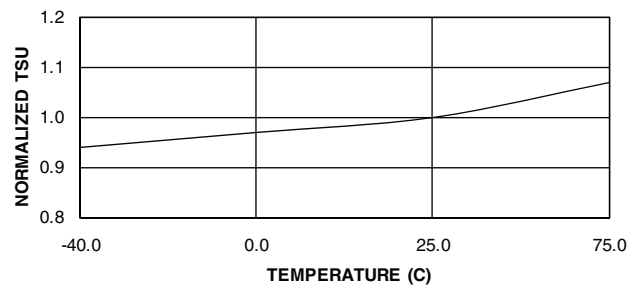
**NORMALIZED  $T_{CO}$  VS. TEMP**



**NORMALIZED  $T_{SU}$  VS.  $V_{CC}$**

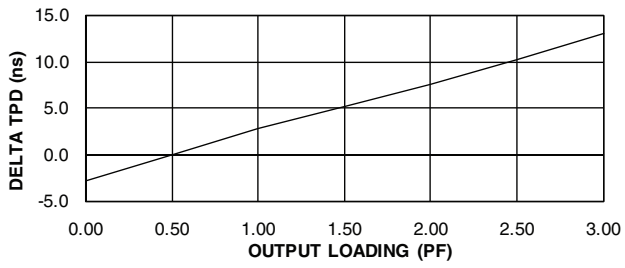


**NORMALIZED  $T_{SU}$  VS. TEMP**

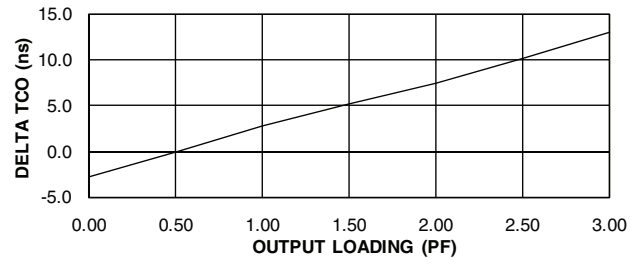




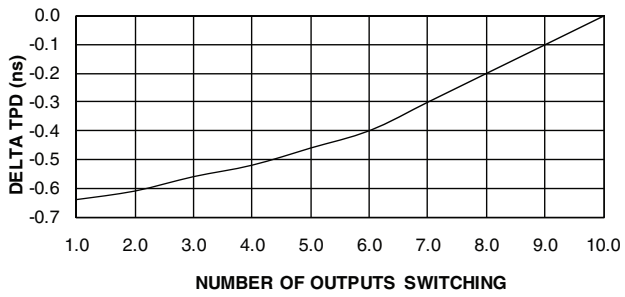
**ATMEL AT22LV10CZ/CQZ  
DELTA T<sub>PD</sub> VS. OUTPUT LOADING**



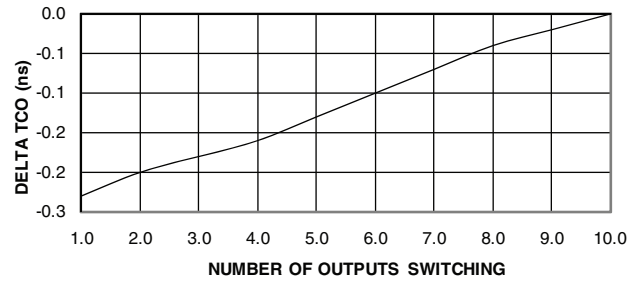
**ATMEL AT22LV10CZ/CQZ  
DELTA T<sub>CO</sub> VS. OUTPUT LOADING**



**DELTA T<sub>PD</sub> VS. # OF OUTPUT SWITCHING**



**DELTA T<sub>CO</sub> VS. # OF OUTPUT SWITCHING**



## 10. Ordering Information

### 10.1 Standard Package Options<sup>(1)</sup>

| t <sub>PD</sub> (ns) | t <sub>S</sub> (ns) | t <sub>CO</sub> (ns) | Ordering Code     | Package | Operation Range                |
|----------------------|---------------------|----------------------|-------------------|---------|--------------------------------|
| 25                   | 15                  | 15                   | ATF22LV10CZ-25JC  | 28J     | Commercial<br>(0-C to 70-C)    |
|                      |                     |                      | ATF22LV10CZ-25PC  | 24P3    |                                |
|                      |                     |                      | ATF22LV10CZ-25SC  | 24S     |                                |
|                      |                     |                      | ATF22LV10CZ-25XC  | 24X     |                                |
|                      |                     |                      | ATF22LV10CZ-25JI  | 28J     | Industrial<br>(-40-C to +85-C) |
|                      |                     |                      | ATF22LV10CZ-25PI  | 24P3    |                                |
|                      |                     |                      | ATF22LV10CZ-25SI  | 24S     |                                |
|                      |                     |                      | ATF22LV10CZ-25XI  | 24X     |                                |
|                      |                     |                      | ATF22LV10CQZ-30JC | 28J     | Commercial<br>(0-C to 70-C)    |
|                      |                     |                      | ATF22LV10CQZ-30PC | 24P3    |                                |
|                      |                     |                      | ATF22LV10CQZ-30SC | 24S     |                                |
|                      |                     |                      | ATF22LV10CQZ-30XC | 24X     |                                |
|                      |                     |                      | ATF22LV10CQZ-30JI | 28J     | Industrial<br>(-40-C to +85-C) |
|                      |                     |                      | ATF22LV10CQZ-30PI | 24P3    |                                |
|                      |                     |                      | ATF22LV10CQZ-30SI | 24S     |                                |
|                      |                     |                      | ATF22LV10CQZ-30XI | 24X     |                                |

Notes: 1. Shaded devices are becoming obsolete and replaced with CQZ-30 parts in green product/package options listed below.

### 10.2 Atmel ATF22LV10CQZ Green Package Options (Pb/Halide-free/RoHS Compliant)

| t <sub>PD</sub> (ns) | t <sub>S</sub> (ns) | t <sub>CO</sub> (ns) | Ordering Code     | Package | Operating Range                |
|----------------------|---------------------|----------------------|-------------------|---------|--------------------------------|
| 30                   | 15                  | 15                   | ATF22LV10CQZ-30JU | 28J     | Industrial<br>(-40-C to +85-C) |
|                      |                     |                      | ATF22LV10CQZ-30PU | 24P3    |                                |
|                      |                     |                      | ATF22LV10CQZ-30SU | 24S     |                                |
|                      |                     |                      | ATF22LV10CQZ-30XU | 24X     |                                |

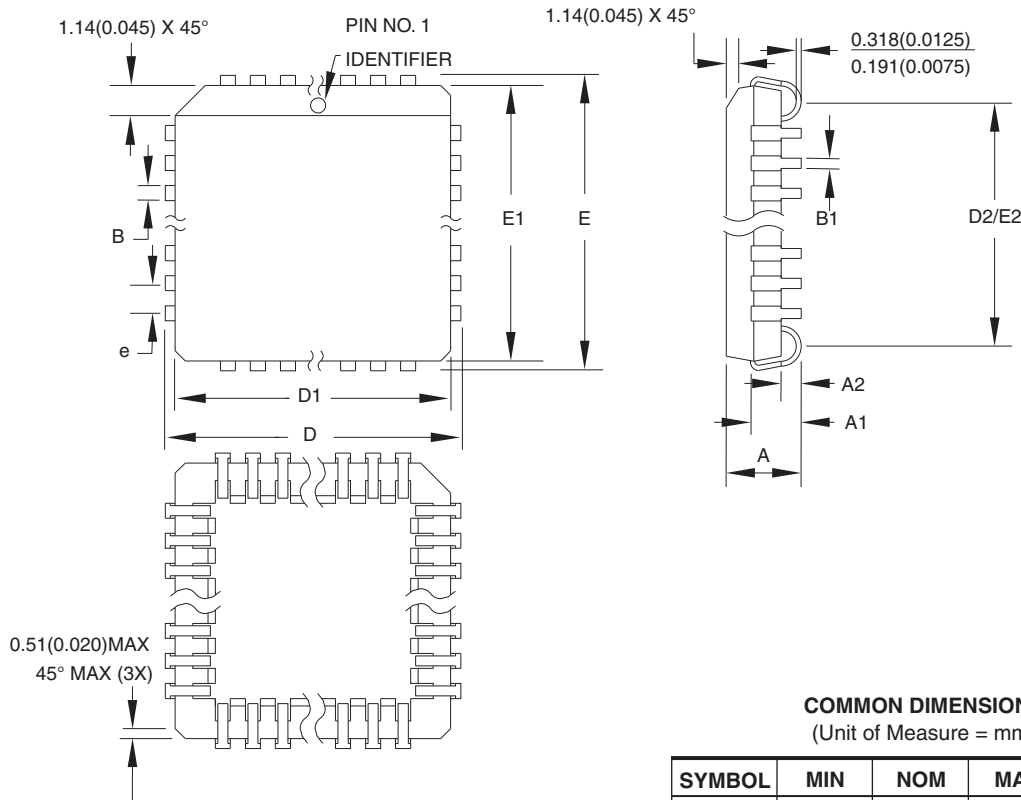
### 10.3 Using “C” Product for Industrial

To use commercial product for industrial temperature ranges, simply de-rate I<sub>CC</sub> by 15% on the “C” device. No speed de-rating is necessary.

| Package Type |   |
|--------------|---|
| <b>28J</b>   | 28-lead, Plastic J-leaded Chip Carrier (PLCC)                   |
| <b>24P3</b>  | 24-pin, 0.300" Wide, Plastic Dual Inline Package (PDIP)         |
| <b>24S</b>   | 24-lead, 0.300" Wide, Plastic Gull Wing Small Outline (SOIC)    |
| <b>24X</b>   | 24-lead, 4.4 mm Wide, Plastic Thin Shrink Small Outline (TSSOP) |

# 11. Packaging Information

## 11.1 28J – PLCC



**COMMON DIMENSIONS**  
(Unit of Measure = mm)

| SYMBOL | MIN       | NOM | MAX    | NOTE   |
|--------|-----------|-----|--------|--------|
| A      | 4.191     | –   | 4.572  |        |
| A1     | 2.286     | –   | 3.048  |        |
| A2     | 0.508     | –   | –      |        |
| D      | 12.319    | –   | 12.573 |        |
| D1     | 11.430    | –   | 11.582 | Note 2 |
| E      | 12.319    | –   | 12.573 |        |
| E1     | 11.430    | –   | 11.582 | Note 2 |
| D2/E2  | 9.906     | –   | 10.922 |        |
| B      | 0.660     | –   | 0.813  |        |
| B1     | 0.330     | –   | 0.533  |        |
| e      | 1.270 TYP |     |        |        |

- Notes:
1. This package conforms to JEDEC reference MS-018, Variation AB.
  2. Dimensions D1 and E1 do not include mold protrusion. Allowable protrusion is .010" (0.254mm) per side. Dimension D1 and E1 include mold mismatch and are measured at the extreme material condition at the upper or lower parting line.
  3. Lead coplanarity is 0.004" (0.102mm) maximum.

10/04/01



Package Drawing Contact:  
packagedrawings@atmel.com

**TITLE**

28J, 28-lead, Plastic J-leaded Chip Carrier (PLCC)

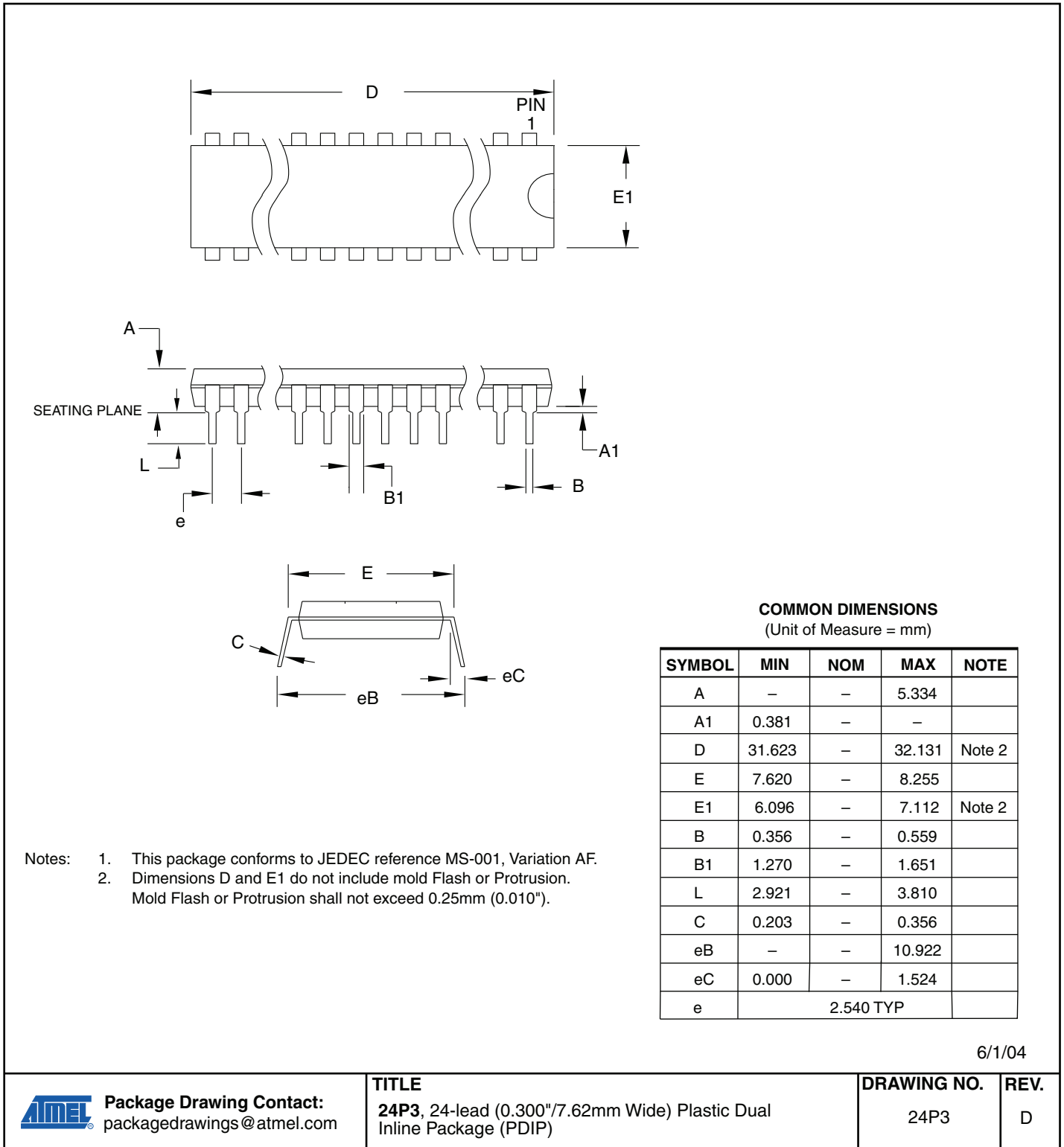
**DRAWING NO.**

28J

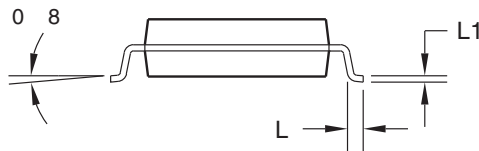
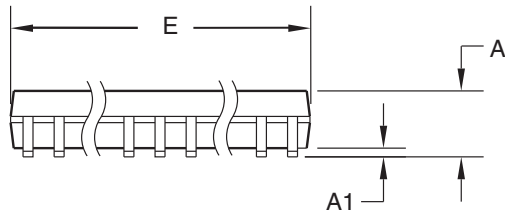
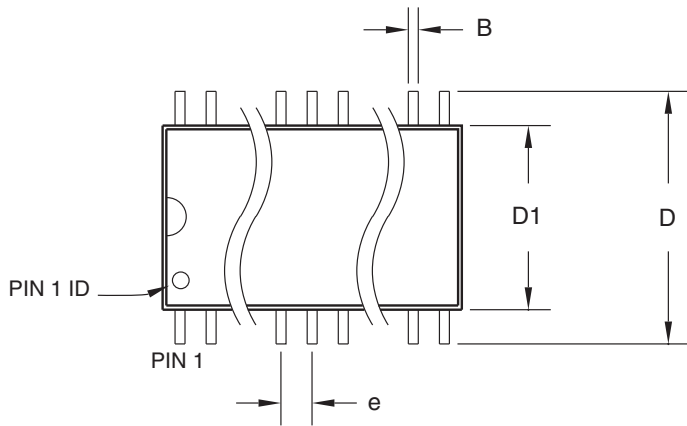
**REV.**

B

## 11.2 24P3 – PDIP



### 11.3 24S – SOIC



**COMMON DIMENSIONS**  
(Unit of Measure = mm)

| SYMBOL | MIN      | NOM | MAX   | NOTE |
|--------|----------|-----|-------|------|
| A      | –        | –   | 2.65  |      |
| A1     | 0.10     | –   | 0.30  |      |
| D      | 10.00    | –   | 10.65 |      |
| D1     | 7.40     | –   | 7.60  |      |
| E      | 15.20    | –   | 15.60 |      |
| B      | 0.33     | –   | 0.51  |      |
| L      | 0.40     | –   | 1.27  |      |
| L1     | 0.23     | –   | 0.32  |      |
| e      | 1.27 BSC |     |       |      |

06/17/2002



**Package Drawing Contact:**  
packagedrawings@atmel.com

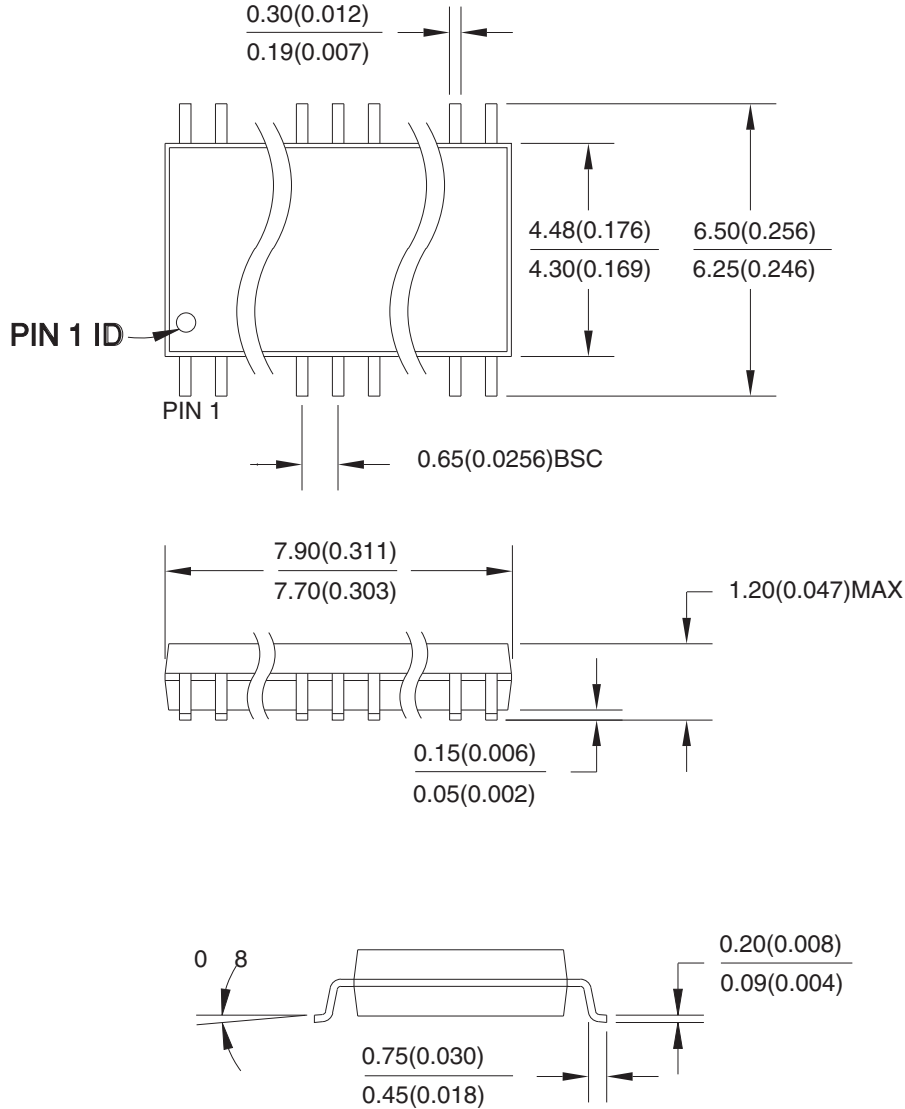
**TITLE**  
24S, 24-lead (0.300" body) Plastic Gull Wing Small  
Outline (SOIC)

| DRAWING NO. | REV. |
|-------------|------|
| 24S         | B    |



## 11.4 24X – TSSOP

Dimensions in Millimeter and (Inches)\*  
 JEDEC STANDARD MO-153 AD  
 Controlling dimension: millimeters



04/11/2001



**Package Drawing Contact:**  
 packagedrawings@atmel.com

**TITLE**  
 24X, 24-lead (4.4mm body width) Plastic Thin Shrink  
 Small Outline Package (TSSOP)

**DRAWING NO.**  
 24X

**REV.**  
 A



## 12. Revision History

| Doc. Rev. | Date    | Comments  |
|-----------|---------|---|
| M         | 07/2010 | Atmel ATF22LV10CZ-25JC/JI, PC/PI, SC/SI, XC/XJ leaded parts will become obsolete. 06/2014 The ATF22LV10CZ is obsolete. Replaced by ATF22LV10CZ. |
| L         | 11/2005 | Added Green Package options   |





## Headquarters

---

**Atmel Corporation**  
2325 Orchard Parkway  
San Jose, CA 95131  
USA  
Tel: (+1)(408) 441-0311  
Fax: (+1)(408) 487-2600  
[www.atmel.com](http://www.atmel.com)

## International

---

**Atmel Asia Limited**  
Unit 01-5 & 16, 19/F  
BEA Tower, Millennium City 5  
418 Kwun Tong Road  
Kwun Tong, Kowloon  
HONG KONG  
Tel: (+852) 2245-6100  
Fax: (+852) 2722-1369

**Atmel Munich GmbH**  
Business Campus  
Parkring 4  
D-85748 Garching b. Munich  
GERMANY  
Tel: (+49) 89-31970-0  
Fax: (+49) 89-3194621

**Atmel Japan**  
9F, Tonetsu Shinkawa Bldg.  
1-24-8 Shinkawa  
Chuo-ku, Tokyo 104-0033  
JAPAN  
Tel: (+81) 3-3523-3551  
Fax: (+81) 3-3523-7581

## Product Contacts

---

**Technical Support**  
[pld@atmel.com](mailto:pld@atmel.com)

**Sales Contact**  
[www.atmel.com/contacts](http://www.atmel.com/contacts)

**Literature Requests**  
[www.atmel.com/literature](http://www.atmel.com/literature)

---

**Disclaimer:** The information in this document is provided in connection with Atmel products. No license, express or implied, by estoppel or otherwise, to any intellectual property right is granted by this document or in connection with the sale of Atmel products. **EXCEPT AS SET FORTH IN ATMEL'S TERMS AND CONDITIONS OF SALE LOCATED ON ATMEL'S WEB SITE, ATMEL ASSUMES NO LIABILITY WHATSOEVER AND DISCLAIMS ANY EXPRESS, IMPLIED OR STATUTORY WARRANTY RELATING TO ITS PRODUCTS INCLUDING, BUT NOT LIMITED TO, THE IMPLIED WARRANTY OF MERCHANTABILITY, FITNESS FOR A PARTICULAR PURPOSE, OR NON-INFRINGEMENT. IN NO EVENT SHALL ATMEL BE LIABLE FOR ANY DIRECT, INDIRECT, CONSEQUENTIAL, PUNITIVE, SPECIAL OR INCIDENTAL DAMAGES (INCLUDING, WITHOUT LIMITATION, DAMAGES FOR LOSS OF PROFITS, BUSINESS INTERRUPTION, OR LOSS OF INFORMATION) ARISING OUT OF THE USE OR INABILITY TO USE THIS DOCUMENT, EVEN IF ATMEL HAS BEEN ADVISED OF THE POSSIBILITY OF SUCH DAMAGES.** Atmel makes no representations or warranties with respect to the accuracy or completeness of the contents of this document and reserves the right to make changes to specifications and product descriptions at any time without notice. Atmel does not make any commitment to update the information contained herein. Unless specifically provided otherwise, Atmel products are not suitable for, and shall not be used in, automotive applications. Atmel's products are not intended, authorized, or warranted for use as components in applications intended to support or sustain life.

© 2010 Atmel Corporation. All rights reserved.

Atmel®, logo and combinations thereof, Everywhere You Are® and others, are registered trademarks or trademarks of Atmel Corporation or its subsidiaries. Other terms and product names may be trademarks of others.