

Applications

- Advanced Driving Assistance System (ADAS)**
 ex. : Camera & Sensing ECU, Image Processing, Emergency Brake Assist ECU
- Car Network**
 ex. : Ethernet, FlexRay, CAN(CAN-FD) Gateway ECU, NFC, etc..
- Power Train and Others**
 ex. : Engine, AT, EPS, ESC, etc..

Features and Structure

- **Small Size** 2.0×1.6×0.7mm
- **High Performance**
 - 24 to 29.99MHz : ±35ppm (-40 to +125°C)
 - 30 to 48MHz : ±65ppm (-40 to +125°C)
- **Economical & Robust Design**
 - Simple structure using Murata's proven package technology
 - Particle screening process for enhanced reliability
- **Meets AEC-Q200 Standards**

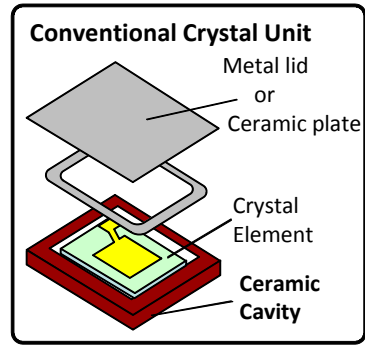
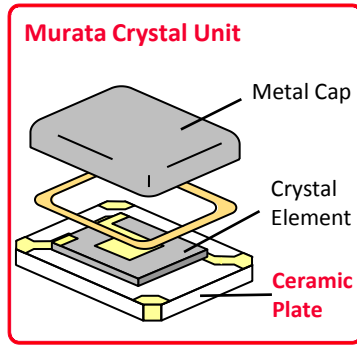

Optimal frequency temperature characteristics across wide temperature range.

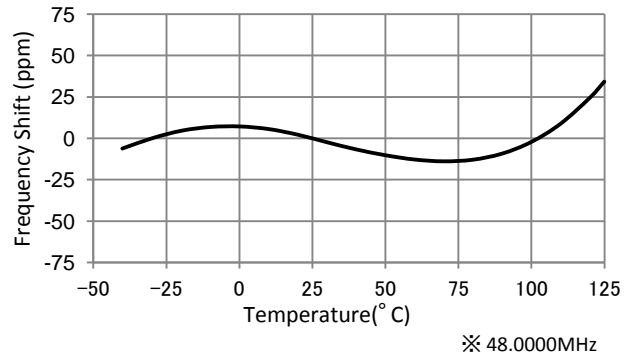
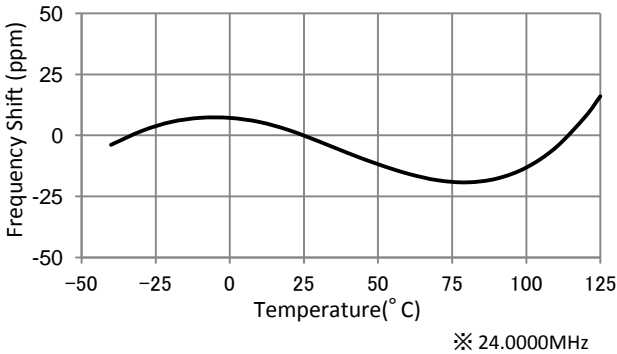

Good solder visibility is achieved by the design of the substrate's four corners.

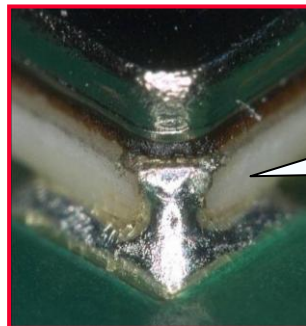
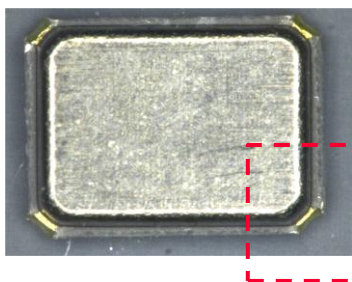

Good solder fillet due to wide corner design.

Unique Method for Particle Screening

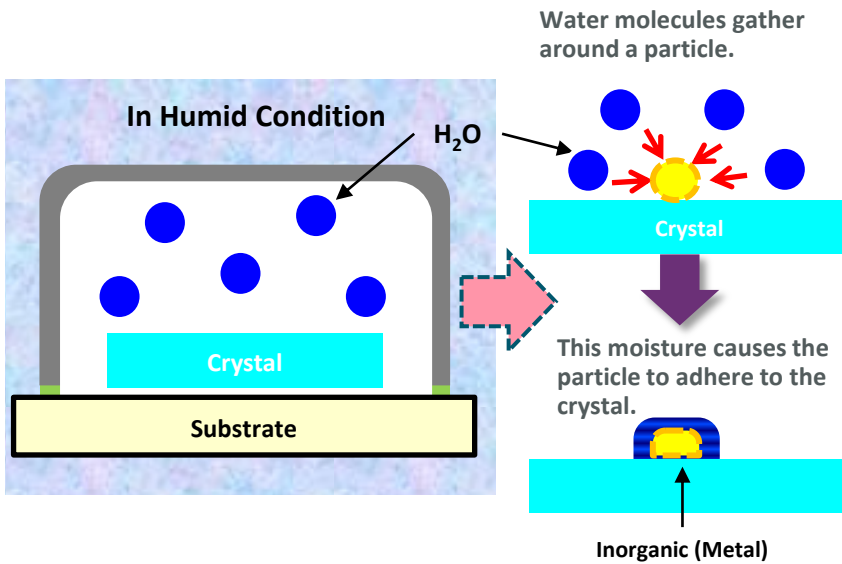

● Murata's particle screening prevents unsuccessful oscillation caused by an inorganic particle since it is detected through our unique screening process.

● If moisture exists inside the cavity of conventional crystal it will affect the oscillation characteristics, therefore it is imperative to add drying process to their production. Due to Murata's crystal unit design, this is not an issue.

Product Line Up

P/N	Freq. [MHz]	Freq. Tolerance (at +25° C) [ppm max.]	Frequency Shift by Temp. (-40 to +125° C) [ppm max.]	ESR [ohm max.]	Frequency Aging [ppm / Y]	Load capacitance [pF]	Drive Level [μW max.]
XRCGB24M000F3A00R0	24.0000	+/-30	+/-35	120	+/-2	6	300
XRCGB25M000F3A00R0	25.0000	+/-30	+/-35	100			
XRCGB26M000F3A00R0	26.0000	+/-30	+/-35	80			
XRCGB27M000F3A00R0	27.0000	+/-30	+/-35	80			
XRCGB27M120F3A00R0	27.1200	+/-30	+/-35	80			
XRCGB48M000F5A00R0	48.0000	+/-50	+/-65	60			

* Additional frequencies to be added to product line up soon : 27.6/30/40 MHz

Dimensions and Land Pattern

(Unit : mm)

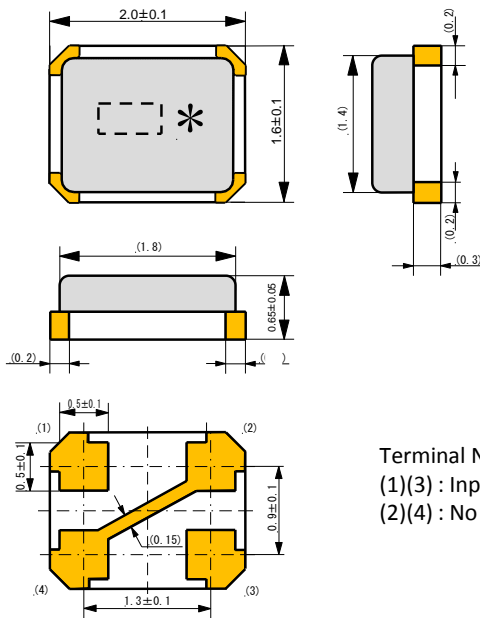

Recommendable Land Pattern

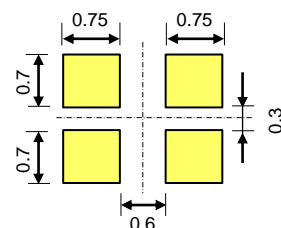

Terminal Number
 (1)(3) : Input / Output
 (2)(4) : No Connect

* You can get more information for these series by visiting the URL or QR code.
<http://www.murata.com/en-global/products/timingdevice/crystalu/xrcgbfa>

