

Datamate

Contents

Introduction

Jackscrew 2.00/4.00mm pitch Mixed Technology Series

- Specifications
- Mating Profiles
- Power Connectors
- Power/Signal Connectors
- Coax Connectors
- Metal Backshells

Jackscrew 2.00mm pitch High-Reliability Connectors

- Specifications
- Mating Profiles
- Female PCB Connectors
- Female Cable Connectors
- Female Cable Assemblies
- Female Metal Backshells
- Male PCB Connectors
- Male Cable Connectors
- Male Metal Backshells

3-Row Jackscrew 2.00mm pitch High-Reliability Connectors

- Specifications
- Mating Profiles
- Female PCB Connectors
- Female Cable Connectors
- Male PCB Connectors

Latched 2.00mm pitch High-Reliability Connectors

- Specifications
- Mating Profiles
- Female PCB Connectors
- Female Cable Connectors
- Female Cable Assemblies
- Male PCB Connectors
- Male Cable Connectors

Tooling



Datamate Introduction

Performance without compromise

Datamate is a 2mm pitch High-Reliability, high performance connector range from Harwin. Approved to British Standard 9525-F0033, the range has a proven track record for performance under extreme conditions.

Datamate provides a low-profile solution for all variations of cable-to-board, board-to-board and cable-to-cable interconnect requirements. The range has seen many developments to match customer and market demands, and now includes 1-, 2- and 3-row configurations, vertical and horizontal in both Throughboard and Surface Mount designs for PCB flexibility. To meet the demanding requirements of vibration, shock and acceleration, added security is available with the options of latches (for space-saving) or jackscrews (for maximum strain-relief).

With the addition of Datamate Mix-Tek, the 3A signal contacts can be supplied in the same connector as 20A power, 40A high power, or 6GHz coax connections, giving complete flexibility of design. Other range additions include the 101Lok fixing – designed for fast mating with a quarter-turn bayonet-style jackscrew.

- ❖ 3A per contact (all electrically loaded; 3.3A per individual contact)
- ❖ 4-finger contact design to maintain electrical contact through high vibration and shock
- ❖ Beryllium Copper Contact for improved temperature range: -55°C to +125°C
- ❖ 500 Mating cycles durability
- ❖ Professional connector system at commercial prices
- ❖ Ongoing development program for High-Reliability connectors from Harwin
- ❖ Online videos and Cable assembly facility for assistance with cabling requirements

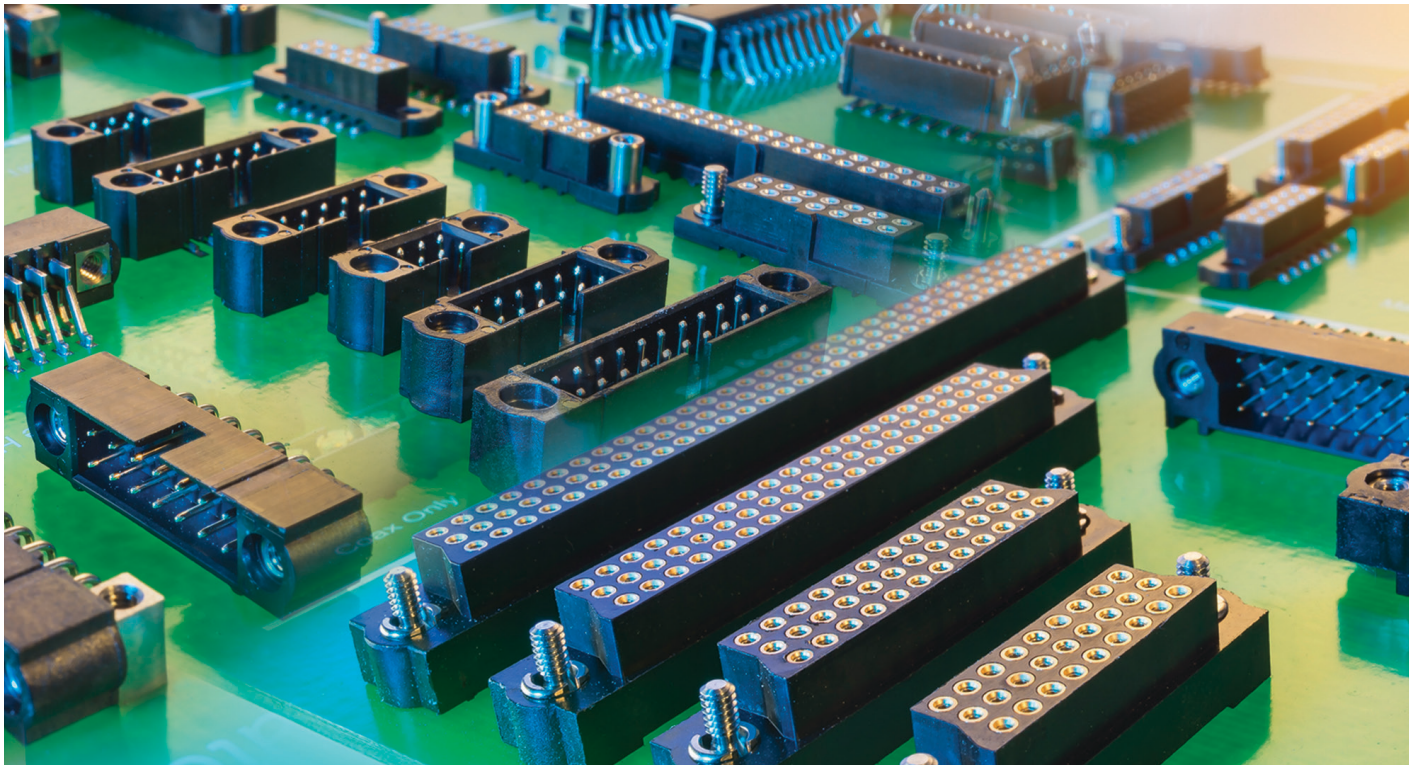

Datamate - Product Features

Four Finger Beryllium Copper Contact

Proven high-reliability contact design ensures signal integrity under extremes of bump, vibration and shock. Durable to over 500 mating cycles.

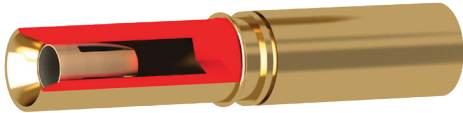

Polarisation

All Datamate designs feature polarisation to prevent mis-mating in everyday use.

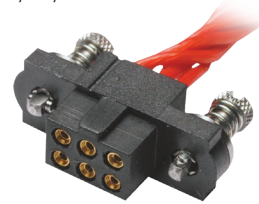

Rugged construction

For use in harsh environments where high vibration, shock and temperature are a consideration.

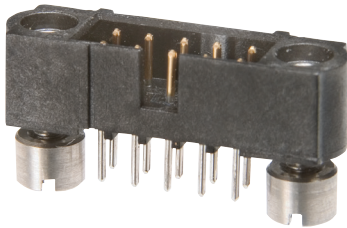

British Standard Specification connections

Approved to BS9525-F0033, complies with CECC 75101-008.

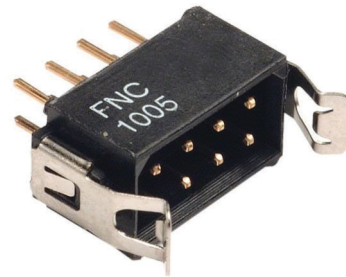

Field proven across the globe

Proven history in aerospace, industrial, defense, oil & gas, etc. Stocked in depth across a global distribution network.

Quality Customer Support

Live Help, 3D CAD models and evaluation samples all available - click on www.harwin.com/datamate.



Datamate - Product Families

Datamate Mix-Tek

3 connector styles in one. Includes low frequency signal, power (20A), high power (40A) and coax (6Ghz) options. A stocked range of coax-only, power-only, high power-only, or mixed power and signal connectors, ideal for COTS requirements.

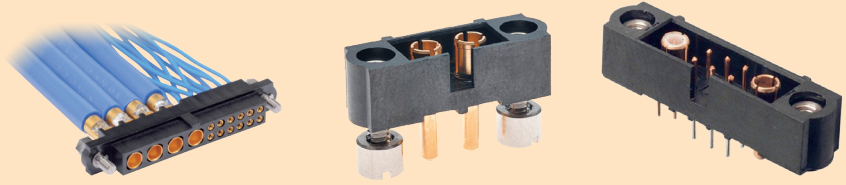

Datamate J-Tek

Datamate low frequency connectors with a variety of optional Jackscrews for increased security of connection. Includes 2-row and 3-row configurations.

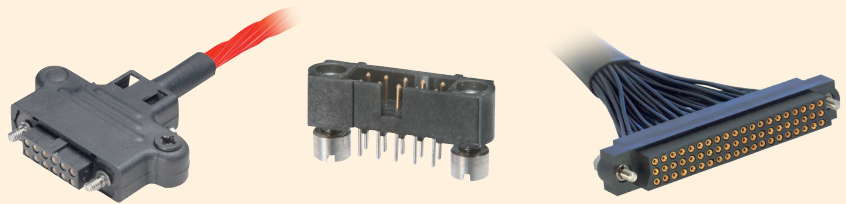

Datamate 101 Lok

101Lok hardware reduces assembly time by simplifying the mating process. The fast mate hardware requires 101-degree turn to securely mate and requires no special tooling.

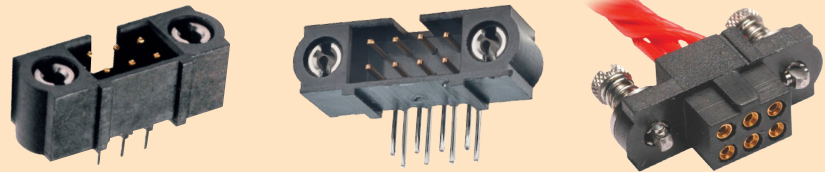

Datamate Trio-Tek

Performing to the same high-reliability standards as conventional Datamate, the Trio-Tek open barrel crimp contact automates the crimp process to significantly save on assembly time and reduce process costs.

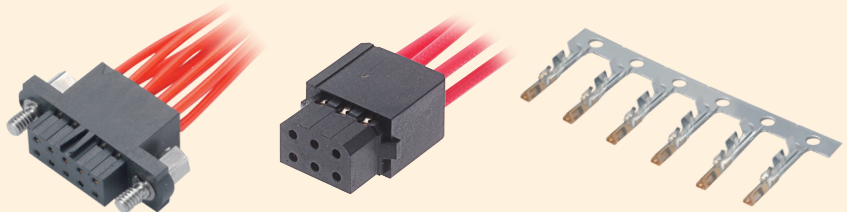

Datamate L-Tek

Datamate low frequency connectors with 3 flexible mating options: friction latch, locking latch and no latch. Includes 1-row and 2-row configurations.

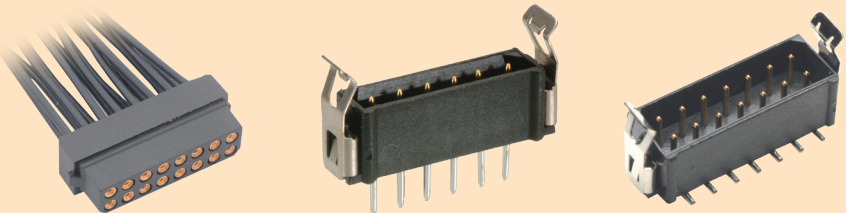

Datamate Mix-Tek Specification

Materials

Mouldings:	Glass-filled thermoplastic UL94V-0
Female contacts:	Brass shell, with Beryllium Copper inner contact
Male contacts:	Copper alloy
Finish:	See individual pages

Electrical

Current	
Individual contacts in isolation:	3.3A max (at 25°C) 2.6A max (at 85°C)
All contacts simultaneously:	3.0A max (at 25°C) 2.2A max (at 85°C)
Working voltage	
At sea level 1013 mbar:	800V DC or AC _{rms}
Voltage proof	
At sea level 1013 mbar:	1,200V DC or AC _{rms}
Contact resistance	
Initial:	20mΩ max
After conditioning:	25mΩ max
Insulation resistance	
Initial:	1,000MΩ min
After conditioning:	100MΩ min

Mechanical

Durability:	500 operations
Insertion force (max):	2.8N
Withdrawal force (min):	0.2N
Signal crimp accommodation:	22 AWG to 28 AWG BS 3G 210 Type A

Environmental

Environmental classification:	55/125/56 days at 95% RH
Operational temperature:	-55°C to +125°C
*Vibration sensitivity:	10Hz to 2000Hz, 0.75mm, 98m/s ² (10G), duration 6h
*Bump severity:	390m/s ² (40G), 4000 ±10 bumps
*Shock severity:	981m/s ² (100G) for 6ms
*Acceleration severity:	490m/s ² (50G)

* Tested with connectors with Jackscrews.

Power Contacts

Materials

Latching collar:	Beryllium Copper, Nickel plated
Other metallic parts:	Copper alloy, Gold plated

Electrical

Current (in isolation)	
32x, 33x:	20A max
PFx, PMx:	40A nominal, up to 80A max
Contact resistance:	6mΩ max

Mechanical

Insertion force (max)	
32x, 33x:	8N
PFx, PMx:	15N
Withdrawal force (min):	0.5N
Contact replacement in connector:	
	5 times
Power contact accommodation	
32x, 33x:	12 to 20 AWG
PFx, PMx:	10 AWG

Coax Contacts

Materials

Latching collar:	Beryllium Copper, Nickel plated
Other metallic parts:	Copper alloy, Gold plated
Insulator:	PTFE

Electrical

Frequency range:	6GHz (depending on cable)
Impedance:	50Ω
VSWR:	1.05 + (0.04 x Frequency) GHz max
Operating voltage (sea level):	180V AC at 500mA
Maximum voltage (sea level):	1000V AC _{rms}
Contact resistance:	6mΩ max
Insulation resistance:	10 ⁶ MΩ at 250V AC _{rms}

Mechanical

Insertion force (max):	8N
Withdrawal force (min):	0.5N
Contact replacement in connector:	5 times

Datamate Mix-Tek Pin Numbering

	FEMALE	MALE
POWER OR COAX ONLY		
SIGNAL AND POWER		

Mating Profiles

		FEMALE	
		VERTICAL PC TAIL	CRIMP
MALE	VERTICAL PC TAIL		
	HORIZONTAL PC TAIL		
	CRIMP		

All dimensions in mm.

Datamate Power Connectors

- Standard high-reliability connectors fitted with power contacts on 4mm pitch.

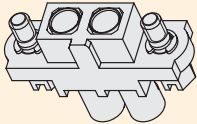
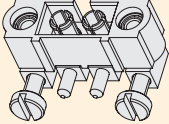
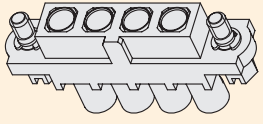
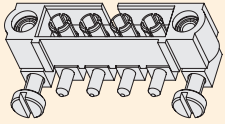
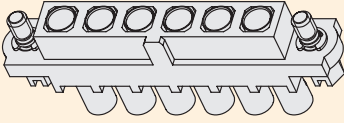
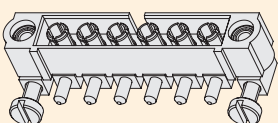
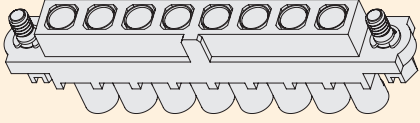
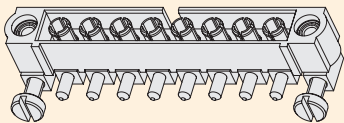
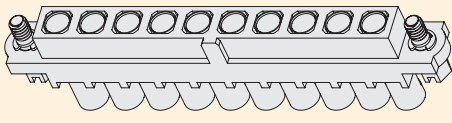
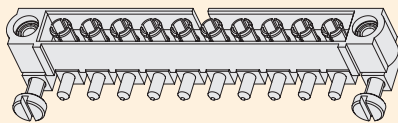
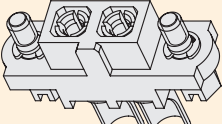
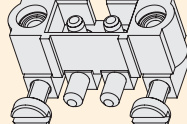
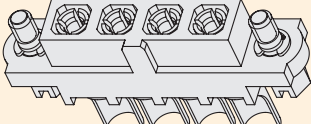
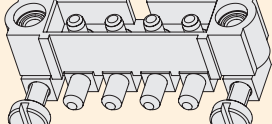
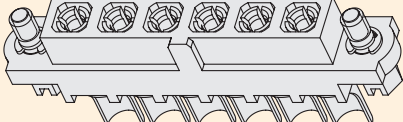
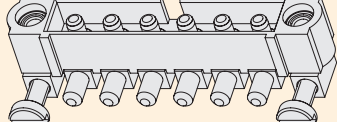
		TYPE	
		Female Cable - Hex Slotted Jackscrews	Male Horizontal 3.5mm PC Tail - 5mm Board Mount Jackcrew
TOTAL NO. OF CONTACTS	2 Power	 M80-4000000F1-02-325-00-000	 M80-5000000M5-02-333-00-000
	4 Power	 M80-4000000F1-04-325-00-000	 M80-5000000M5-04-333-00-000
	6 Power	 M80-4000000F1-06-325-00-000	 M80-5000000M5-06-333-00-000
	8 Power	 M80-4000000F1-08-325-00-000	 M80-5000000M5-08-333-00-000
	10 Power	 M80-4000000F1-10-325-00-000	 M80-5000000M5-10-333-00-000
	2 High Power	 M80-4000000F1-02-PF5-00-000	 M80-5000000M5-02-PM3-00-000
	4 High Power	 M80-4000000F1-04-PF5-00-000	 M80-5000000M5-04-PM3-00-000
	6 High Power	 M80-4000000F1-06-PF5-00-000	 M80-5000000M5-06-PM3-00-000

All dimensions in mm.

Datamate Power Connectors

- Standard high-reliability connectors fitted with power contacts on 4mm pitch.

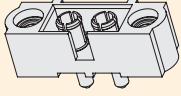
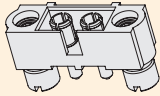
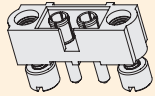
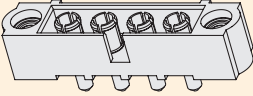
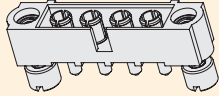
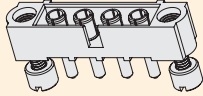
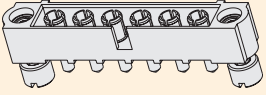
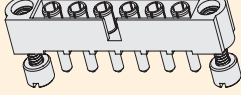
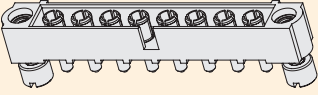
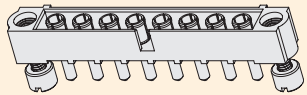
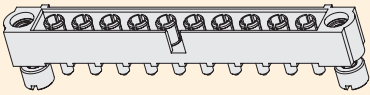
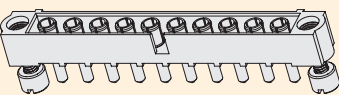
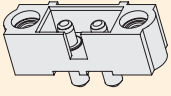
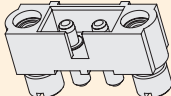
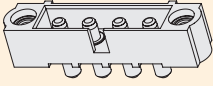
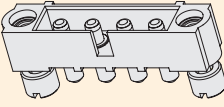
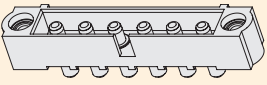
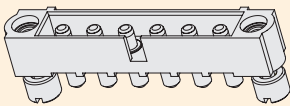
		TYPE		
		Male Vertical 3.5mm PC Tail - Jackscrew Fixing	Male Vertical 3.5mm PC Tail - 3.5mm Board Mount Jackcrew	Male Vertical 5mm PC Tail - 5mm Board Mount Jackcrew
TOTAL NO. OF CONTACTS	2 Power	 M80-5000000M1-02-331-00-000	 M80-5000000M2-02-331-00-000	 M80-5000000M3-02-332-00-000
	4 Power	 M80-5000000M1-04-331-00-000	 M80-5000000M2-04-331-00-000	 M80-5000000M3-04-332-00-000
	6 Power		 M80-5000000M2-06-331-00-000	 M80-5000000M3-06-332-00-000
	8 Power		 M80-5000000M2-08-331-00-000	 M80-5000000M3-08-332-00-000
	10 Power		 M80-5000000M2-10-331-00-000	 M80-5000000M3-10-332-00-000
	2 High Power	 M80-5000000M1-02-PM1-00-000	 M80-5000000M2-02-PM1-00-000	
	4 High Power	 M80-5000000M1-04-PM1-00-000	 M80-5000000M2-04-PM1-00-000	
	6 High Power	 M80-5000000M1-06-PM1-00-000	 M80-5000000M2-06-PM1-00-000	

Datamate Power Connectors

Female Power Cable Connector Kit

- Part numbers are for a complete kit of a housing and the applicable number of contacts.
- Hexagonal slotted jackscrews are assembled where specified.
- Polarised mouldings.
- Standard Power contacts rated to 20A, High Power to 40A.



DATAMATE POWER

POWER CONTACTS ONLY		CALCULATION		SPARE SOLDER CONTACTS	
Standard Power (12 AWG)		A	B + 14	Standard Power (12 AWG)	
		B	(No. of Power contacts - 1) x 4		
		C	B + 9		
High Power (10 AWG)				High Power (10 AWG)	
				ORDER CODE M80-325	
				ORDER CODE M80-PF5	
TOOLS		WIRE STRIPPING DETAILS			
Contact Removal Tool - Z80-290 No special tooling required for connecting wire, other than standard soldering equipment.					
HOW TO ORDER					
M80 - 4000000F1 - XX - XXX - 00 - 000					
NO. OF POWER CONTACTS				JACKSCREW	
02, 04, 06, 08, 10	Standard Power			325	Standard Power
02, 04, 06	High Power			PF5	High Power

All dimensions in mm.

Datamate Power Connectors

Male Vertical PC Tail

- ❖ A selection of stocked Datamate Mix-Tek solder tail standard layouts.
- ❖ Choice to suit two PCB thicknesses and two stud lengths.
- ❖ Standard Power contacts rated to 20A.
- ❖ High Power rated to 40A nominal, up to 80A max.

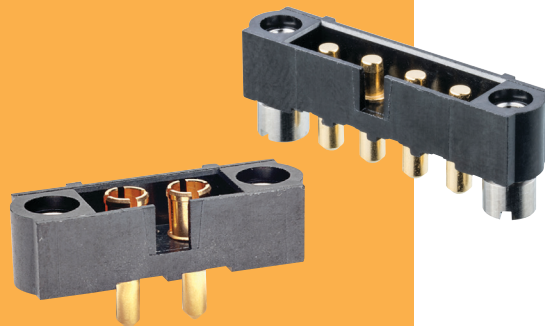

DATAMATE POWER

STANDARD POWER

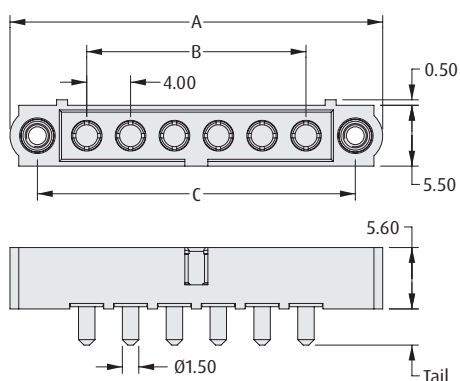

Jackscrew fixing

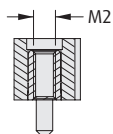

Jackscrew with Board Mount

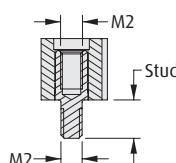

Recommended PC Board Pattern

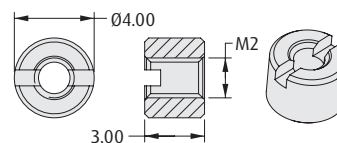
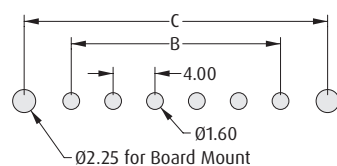

Board Mount Nut, 2 per connector

CALCULATION

A	$B + 14$
B	$(\text{No. of Power contacts} - 1) \times 4$
C	$B + 9$

HIGH POWER

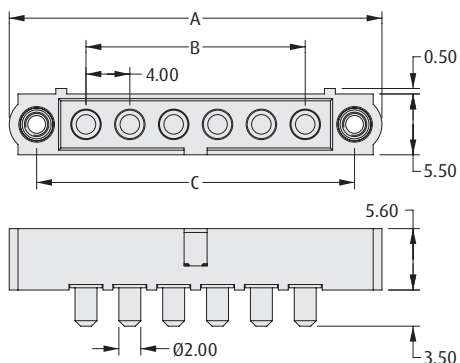

Jackscrew fixing

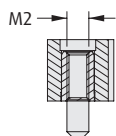

Jackscrew with Board Mount

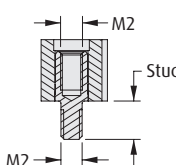

Recommended PC Board Pattern

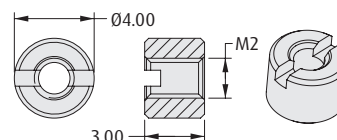
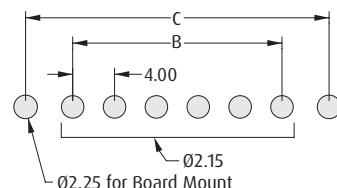

Board Mount Nut, 2 per connector

HOW TO ORDER

M80 - 5000000 XX - XX - XXX - 00 - 000

JACKSCREW

M1	Jackscrew only
M2	With 3.5mm Board Mount stud
M3	With 5mm Board Mount stud

Check image chart to confirm Off-The-Shelf sizes available

NO. OF POWER CONTACTS

02, 04	Standard Power (M1 Jackscrews)
02, 04, 06, 08, 10	Standard Power (M2/M3 Jackscrews)
02, 04, 06	High Power (M1/M2 Jackscrews)

POWER CONTACTS PART NO.

331	3.5mm Tail Standard Power
332	5mm Tail Standard Power
PM1	3.5mm Tail High Power

All dimensions in mm.

Datamate Power Connectors

Male Horizontal PC Tail

- Choice to suit two PCB thicknesses and two stud lengths.
- Standard Power contacts rated to 20A.
- High Power rated to 40A nominal, up to 80A max.



STANDARD POWER

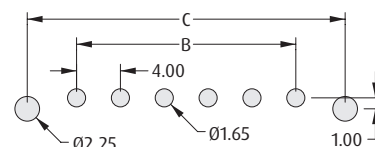
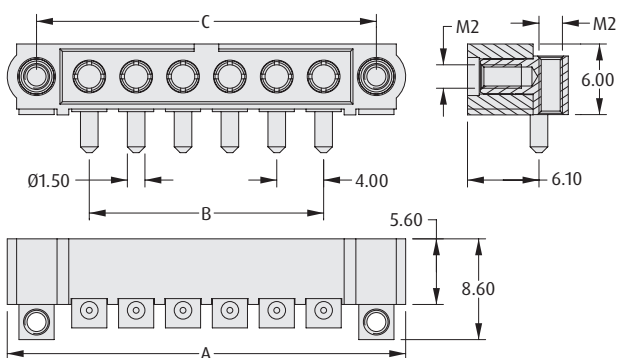

Recommended PC Board Pattern

Board Mount Bolt,
2 per connector

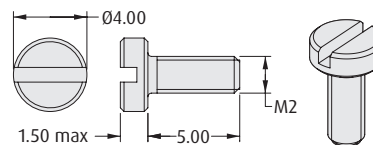

CALCULATION

A	$B + 14$
B	$(\text{No. of Power contacts} - 1) \times 4$
C	$B + 9$

HIGH POWER

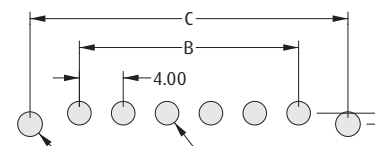
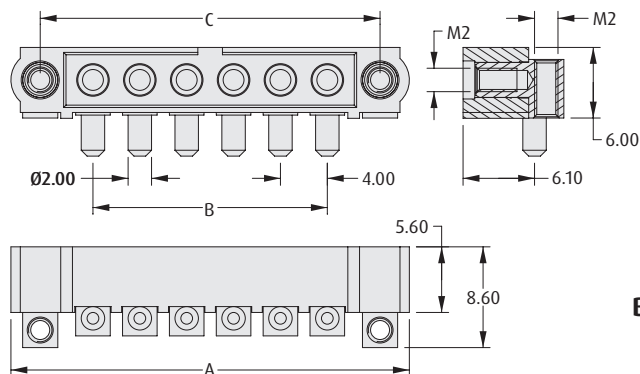

Recommended PC Board Pattern

Board Mount Bolt,
2 per connector

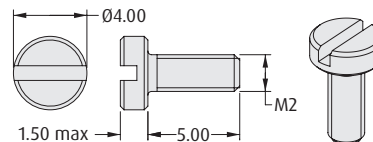

HOW TO ORDER

M80 - 500000 M5 - XX - XXX - 00 - 000

NO. OF POWER CONTACTS	
02, 04, 06, 08, 10	Standard Power
02, 04, 06,	High Power

POWER CONTACTS PART NO.	
333	3.5mm Tail Standard Power
PM3	3.5mm Tail High Power

All dimensions in mm.

Datamate Power/Signal Connectors

- Standard high-reliability connectors fitted with a combination of signal and 20A power contacts.

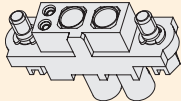
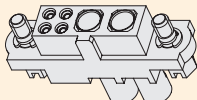
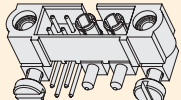
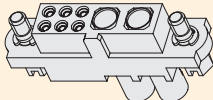
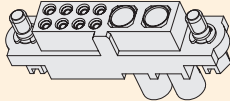
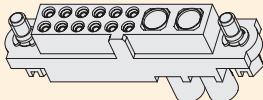
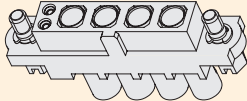
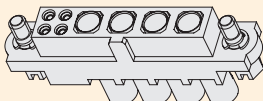
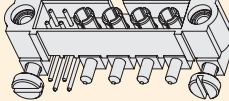
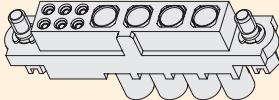
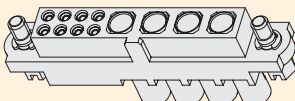
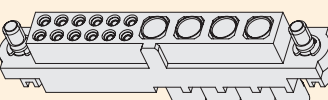
		TYPE	
		Female Cable - Hex Slotted Jackscrews	Male Horizontal 3mm PC Tail - 5mm Board Mount Jackcrew
TOTAL NO. OF CONTACTS	2 Power	 <p>M80-4C10205F1-02-325-00-000</p>	
	4 Signal	 <p>M80-4C10405F1-02-325-00-000</p>	 <p>M80-5L10405M5-02-333-00-000</p>
	6 Signal	 <p>M80-4C10605F1-02-325-00-000</p>	
	8 Signal	 <p>M80-4C10805F1-02-325-00-000</p>	
	12 Signal	 <p>M80-4C11205F1-02-325-00-000</p>	
TOTAL NO. OF CONTACTS	4 Power	 <p>M80-4C10205F1-04-325-00-000</p>	
	4 Signal	 <p>M80-4C10405F1-04-325-00-000</p>	 <p>M80-5L10405M5-04-333-00-000</p>
	6 Signal	 <p>M80-4C10605F1-04-325-00-000</p>	
	8 Signal	 <p>M80-4C10805F1-04-325-00-000</p>	
	12 Signal	 <p>M80-4C11205F1-04-325-00-000</p>	

All dimensions in mm.

Datamate Power/Signal Connectors

DATAMATE POWER/SIGNAL

- Standard high-reliability connectors fitted with a combination of signal and 20A power contacts.

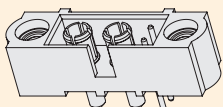
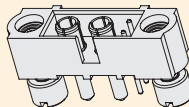
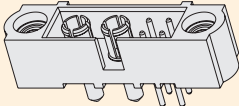
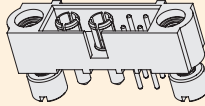
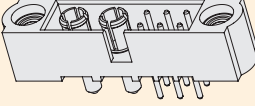
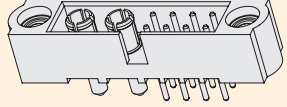
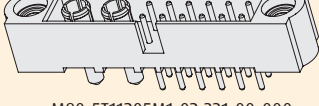
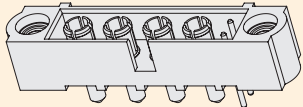
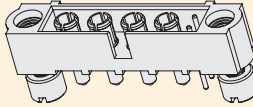
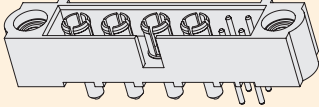
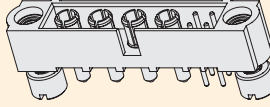
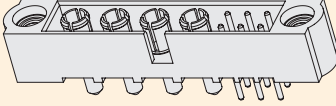
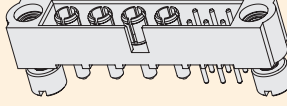
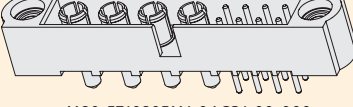
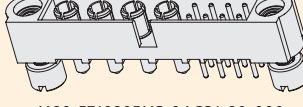
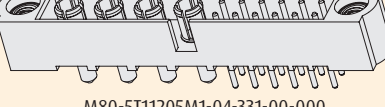
		TYPE	
		Male Vertical 3mm PC Tail - Jackscrew fixing	Male Vertical 3mm PC Tail - 3.5mm Board Mount Jackcrew
TOTAL NO. OF CONTACTS	2 Power	2 Signal  M80-5T10205M1-02-331-00-000	 M80-5T10205M2-02-331-00-000
		4 Signal  M80-5T10405M1-02-331-00-000	 M80-5T10405M2-02-331-00-000
		6 Signal  M80-5T10605M1-02-331-00-000	
		8 Signal  M80-5T10805M1-02-331-00-000	
		12 Signal  M80-5T11205M1-02-331-00-000	
TOTAL NO. OF CONTACTS	4 Power	2 Signal  M80-5T10205M1-04-331-00-000	 M80-5T10205M2-04-331-00-000
		4 Signal  M80-5T10405M1-04-331-00-000	 M80-5T10405M2-04-331-00-000
		6 Signal  M80-5T10605M1-04-331-00-000	 M80-5T10605M2-04-331-00-000
		8 Signal  M80-5T10805M1-04-331-00-000	 M80-5T10805M2-04-331-00-000
		12 Signal  M80-5T11205M1-04-331-00-000	

All dimensions in mm.

Datamate Power/Signal Connectors

Female Power/Signal Cable Connector Kit

- ❖ Part numbers are for a complete kit of a housing and the applicable number of contacts.
- ❖ Hexagonal slotted jackscrews are assembled.
- ❖ Polarised mouldings.
- ❖ Standard Power contacts rated to 20A, signal to 3A.



DATAMATE POWER/SIGNAL

SIGNAL AND POWER	CALCULATION	SPARE CONTACTS						
	<table border="1"> <tr> <td>A</td> <td>B + 13</td> </tr> <tr> <td>B</td> <td>(No. of Power contacts - 1) x 4 + Total no. of Signal contacts + 1</td> </tr> <tr> <td>C</td> <td>B + 8</td> </tr> </table>	A	B + 13	B	(No. of Power contacts - 1) x 4 + Total no. of Signal contacts + 1	C	B + 8	<p>Signal (24 to 28 AWG)</p> <p>Indent Groove</p> <p style="background-color: #f4a460; color: white; padding: 2px;">ORDER CODE M80-0130005</p> <p>Standard Power (12 AWG)</p> <p style="background-color: #f4a460; color: white; padding: 2px;">ORDER CODE M80-325</p>
	A	B + 13						
	B	(No. of Power contacts - 1) x 4 + Total no. of Signal contacts + 1						
C	B + 8							
<p>TOOLS</p> <p>Recommended Crimp Tool (Signal) - M22520/2-01 Positioner (Signal) - T5747 Contact Insertion/Removal Tool (Signal) - Z80-280 Contact Removal Tool (Power) - Z80-290</p> <ul style="list-style-type: none"> ❖ No special tooling required for connecting Power wire, other than standard soldering equipment. ❖ Instruction sheets available at www.harwin.com/instructions. 	<p>WIRE STRIPPING DETAILS</p> <p>01.10 max for Signal 02.25 for Standard Power</p> <p>2.00 for Signal 5.00 for Standard Power</p>							
<p>HOW TO ORDER</p> <p style="font-size: 1.2em; font-weight: bold;">M80 - 4C1 <u>XX</u> 05F1 - <u>XX</u> - 325 - 00 - 000</p> <table border="1" style="width: 100%; border-collapse: collapse;"> <tr> <td style="width: 30%; background-color: #f4a460; color: white; padding: 5px;">NO. OF SIGNAL CONTACTS</td> <td style="width: 40%;"></td> <td style="width: 30%; background-color: #f4a460; color: white; padding: 5px;">NO. OF POWER CONTACTS</td> </tr> <tr> <td style="background-color: #f4a460; color: white; padding: 5px;">02, 04, 06, 08, 12</td> <td></td> <td style="background-color: #f4a460; color: white; padding: 5px;">02, 04</td> </tr> </table> <p style="font-size: 0.8em;">Check image chart to confirm Off-The-Shelf sizes available</p>			NO. OF SIGNAL CONTACTS		NO. OF POWER CONTACTS	02, 04, 06, 08, 12		02, 04
NO. OF SIGNAL CONTACTS		NO. OF POWER CONTACTS						
02, 04, 06, 08, 12		02, 04						

All dimensions in mm.

Datamate Power/Signal Connectors

Male Power/Signal Vertical PC Tail

- A selection of stocked Datamate Mix-Tek solder tail standard layouts.
- Choice to suit two PCB thicknesses and two stud lengths.
- Polarised mouldings.
- Standard Power contacts rated to 20A, signal to 3A.

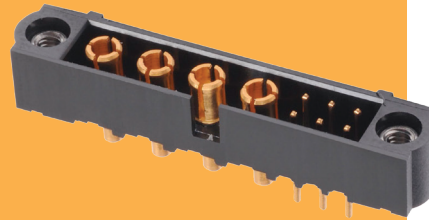

JACKSCREW ONLY

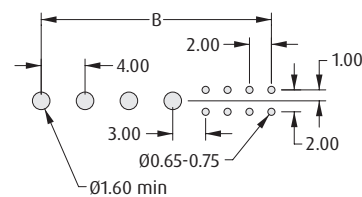
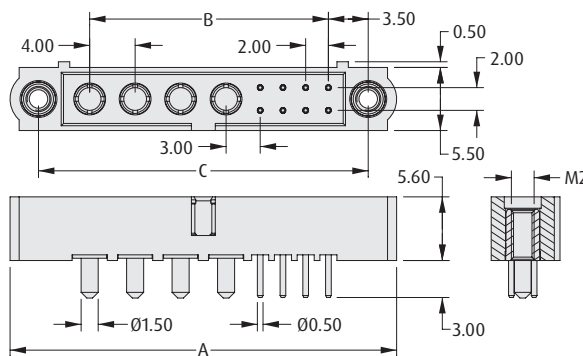

Recommended PC Board Pattern

CALCULATION

A	$B + 13$
B	(No. of Power contacts - 1) x 4 + Total no. of Signal contacts + 1
C	$B + 8$

WITH BOARD MOUNT

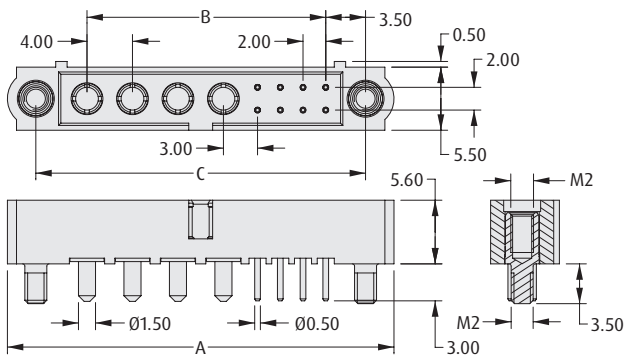

**Board Mount Nut,
2 per connector**

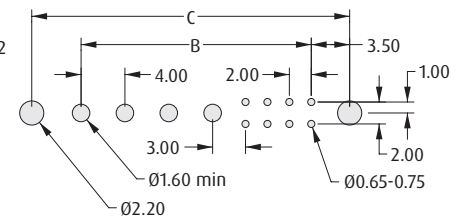

Recommended PC Board Pattern

HOW TO ORDER

M80 - 5T1 XX 05 XX - XX - 331 - 00 - 000

NO. OF SIGNAL CONTACTS

02, 04, 06, 08, 12

NO. OF POWER CONTACTS

02, 04

JACKSCREW

M1	Jackscrew only
M2	With 3.5mm Board Mount stud

Check image chart to confirm Off-The-Shelf sizes available

All dimensions in mm.

Datamate Power/Signal Connectors

Male Power/Signal Horizontal PC Tail

- ❖ A selection of stocked Datamate Mix-Tek solder tail standard layouts.
- ❖ Choice to suit two PCB thicknesses and two stud lengths.
- ❖ Polarised mouldings.
- ❖ Standard Power contacts rated to 20A, signal to 3A.

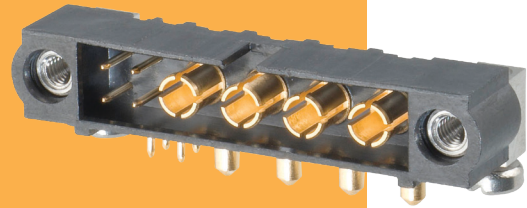

DATAMATE POWER/SIGNAL

SIGNAL AND POWER

CALCULATION

A	$B + 13$
B	(No. of Power contacts - 1) x 4 + Total no. of Signal contacts + 1
C	$B + 8$

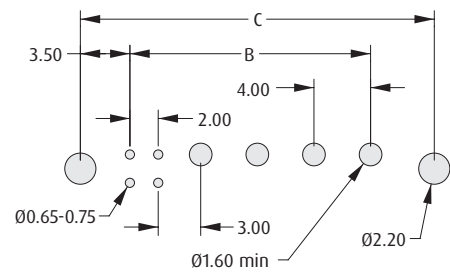
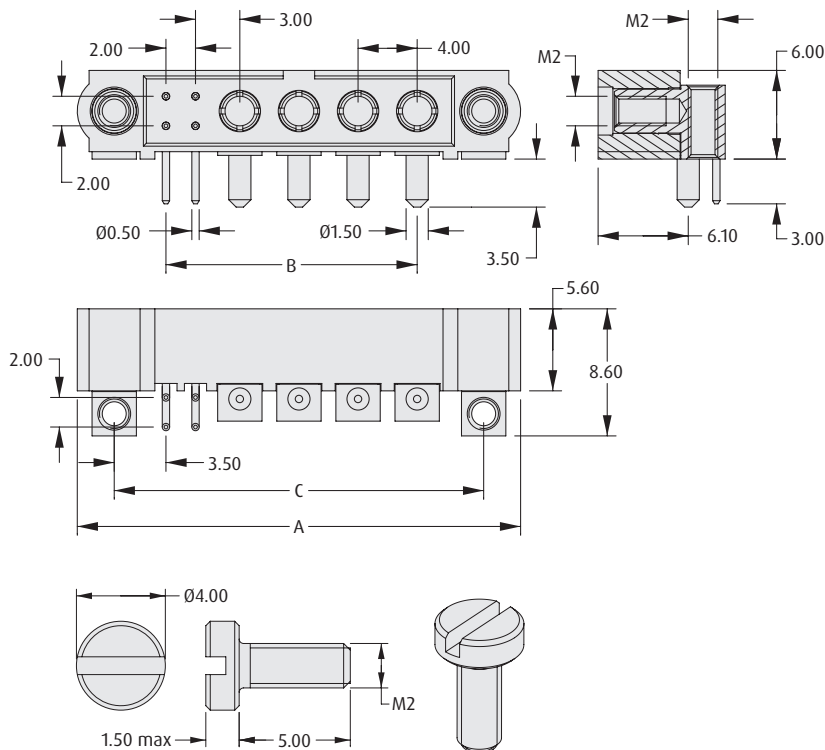

Recommended PC Board Pattern

Board Mount Bolt, 2 per connector

HOW TO ORDER

M80 - 5L1 04 05 M5 - XX - 333 - 00 - 000

NO. OF SIGNAL CONTACTS

04

NO. OF POWER CONTACTS

02, 04

All dimensions in mm.

Datamate Coax Connectors

- Standard high-reliability connectors fitted with coax contacts on 4mm pitch.

DATAMATE COAX

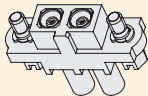
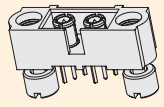
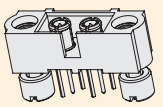
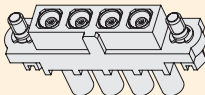
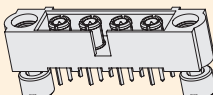
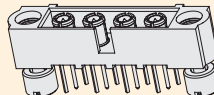
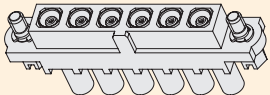
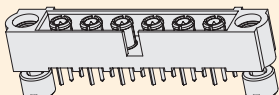
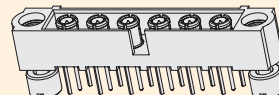
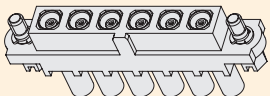
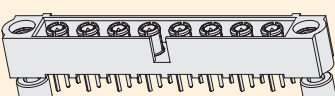
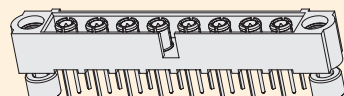
		TYPE		
		Female Cable Connectors - Hex Slotted Jackscrews	Male Vertical 3mm PC Tail - 3.5mm Board Mount Jackcrew	Male Vertical 4.5mm PC Tail - 5mm Board Mount Jackcrew
TOTAL NO. OF CONTACTS	2 Coax	 M80-FC305F1-02	 M80-MV311M2-02	 M80-MV312M3-02
	4 Coax	 M80-FC305F1-04	 M80-MV311M2-04	 M80-MV312M3-04
	6 Coax	 M80-FC305F1-06	 M80-MV311M2-06	 M80-MV312M3-06
	8 Coax	 M80-FC305F1-08	 M80-MV311M2-08	 M80-MV312M3-08

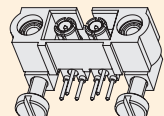
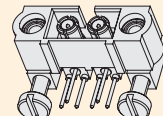
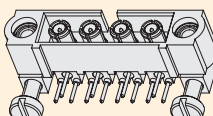
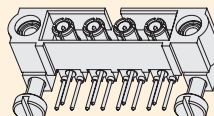
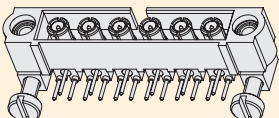
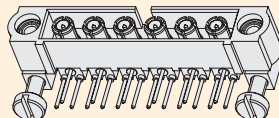
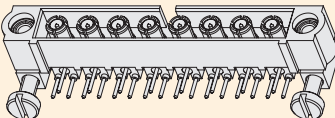
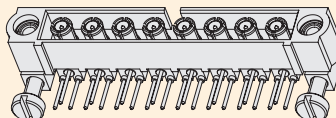
		TYPE		
		Female Cable Assemblies - Hex Slotted Jackscrews	Male Horizontal 3mm PC Tail - 5mm Board Mount Jackcrew	Male Horizontal 4.5mm PC Tail - 5mm Board Mount Jackcrew
TOTAL NO. OF CONTACTS	2 Coax	Single Ended (Female to Cut End) M80-FC305F1-02-0150L Double Ended (Female to Female) M80-FC305F1-02-0150F1	 M80-MH313M5-02	 M80-MH314M5-02
	4 Coax	Single Ended (Female to Cut End) M80-FC305F1-04-0150L Double Ended (Female to Female) M80-FC305F1-04-0150F1	 M80-MH313M5-04	 M80-MH314M5-04
	6 Coax	Single Ended (Female to Cut End) M80-FC305F1-06-1050L Double Ended (Female to Female) M80-FC305F1-06-0150F1	 M80-MH313M5-06	 M80-MH314M5-06
	8 Coax	Single Ended (Female to Cut End) M80-FC305F1-08-0150L Double Ended (Female to Female) M80-FC305F1-08-0150F1	 M80-MH313M5-08	 M80-MH314M5-08

Datamate Coax Connectors

Jack (Female) Crimp Kit

- ❖ A selection of stocked jack cable connectors in standard layouts.
- ❖ 6GHz, 50Ω Coax contacts, suitable for RG178 cable.
- ❖ Product supplied as a complete kit; housing with jackscrews assembled, and the applicable number of coax contacts supplied loose, not assembled.
- ❖ Polarised mouldings.
- ❖ Hexagonal slotted jackscrew style.

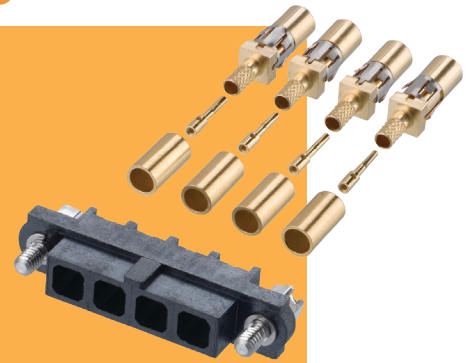

DATAMATE COAX

CABLE	CALCULATION	SPARE COAX CONTACTS							
	<table border="1"> <tr> <td>A</td> <td>$B + 14$</td> </tr> <tr> <td>B</td> <td>$(\text{No. of Coax contacts} - 1) \times 4$</td> </tr> <tr> <td>C</td> <td>$B + 9$</td> </tr> </table>	A	$B + 14$	B	$(\text{No. of Coax contacts} - 1) \times 4$	C	$B + 9$		
A	$B + 14$								
B	$(\text{No. of Coax contacts} - 1) \times 4$								
C	$B + 9$								
		<table border="1"> <tr> <td style="background-color: #f4a460;">ORDER CODE</td> </tr> <tr> <td>M80-305</td> </tr> </table>	ORDER CODE	M80-305					
ORDER CODE									
M80-305									
TOOLS	WIRE STRIPPING DETAILS								
<p>Recommended Inner Contact Crimp Tool - Z80-292</p> <p>Positioner for Inner Contact - Z80-291</p> <p>Recommended Outer Sleeve Crimp Tool - Z80-293</p> <p>Contact Removal Tool - Z80-290</p> <p>❖ Instruction sheets available at www.harwin.com/instructions.</p>									
HOW TO ORDER									
<p>M80 - FC 305 F1 - XX</p>									
<table border="1"> <tr> <th colspan="2" style="background-color: #f4a460;">COAX CONTACT TYPE</th> </tr> <tr> <td style="background-color: #f4a460;">305</td> <td>Ø2.00mm cable</td> </tr> </table>	COAX CONTACT TYPE		305	Ø2.00mm cable	<table border="1"> <tr> <th colspan="2" style="background-color: #f4a460;">NO. OF COAX CONTACTS</th> </tr> <tr> <td style="background-color: #f4a460;">02, 04, 06, 08</td> <td></td> </tr> </table>	NO. OF COAX CONTACTS		02, 04, 06, 08	
COAX CONTACT TYPE									
305	Ø2.00mm cable								
NO. OF COAX CONTACTS									
02, 04, 06, 08									

All dimensions in mm.

Datamate Coax Connectors

Jack (Female) Cable Assemblies

- ❏ A selection of stocked ganged multipoint coaxial cable assemblies in standard layouts.
- ❏ 6GHz, 50Ω Coax contacts, assembled with RG178 cable.
- ❏ Hexagonal slotted jackscrew style.
- ❏ For non-standard cable lengths, please visit harwin.com/cable-assemblies and fill in your requirements.

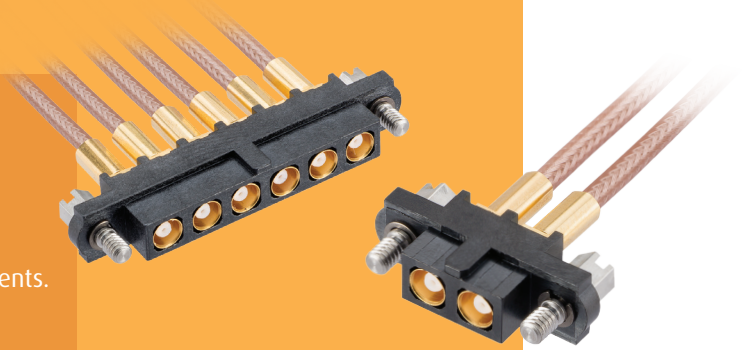

FEMALE SINGLE ENDED

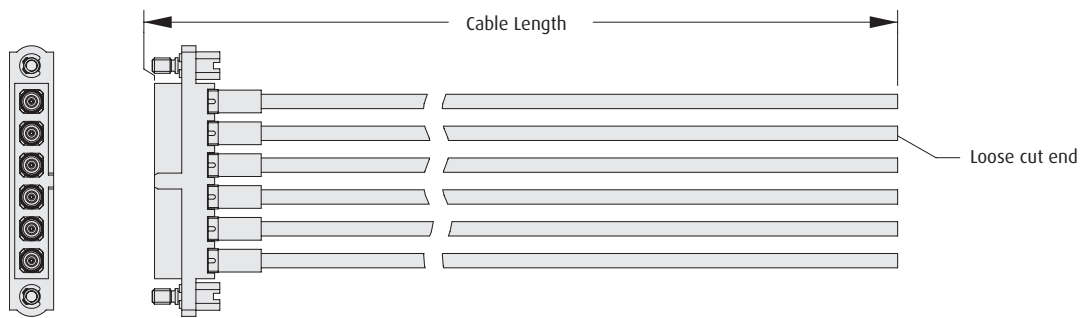

FEMALE - FEMALE

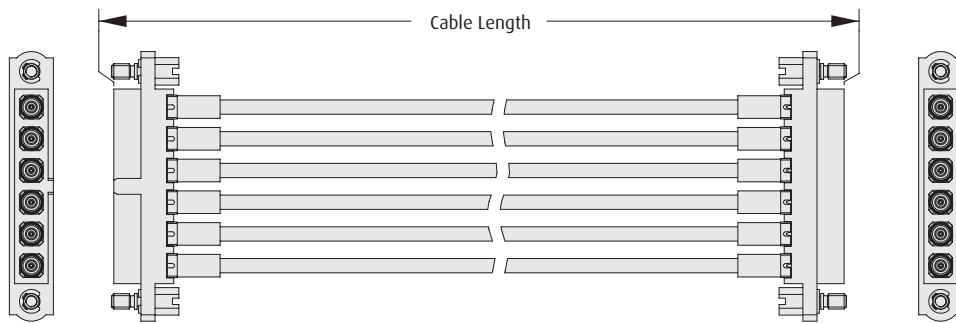

HOW TO ORDER

M80 - FC305F1 - XX - 0150 X

SERIES CODE

NO. OF POWER CONTACTS

02, 04, 06, 08

TERMINATION - SECOND END

L	Loose cut end
F1	Female connector

CABLE LENGTH

0150 150mm

All dimensions in mm.

Datamate Coax Connectors

DATAMATE COAX

Plug (Male) Vertical PC Tail

- Stocked coax connectors in vertical orientation, with board-mount jackscrews for added security.
- 6GHz, 50Ω Coax contacts.
- Choice to suit two PCB thicknesses.
- Order board mount nuts separately.
- Screwdriver **Z80-298** available for assembling slotted jackscrew nuts.

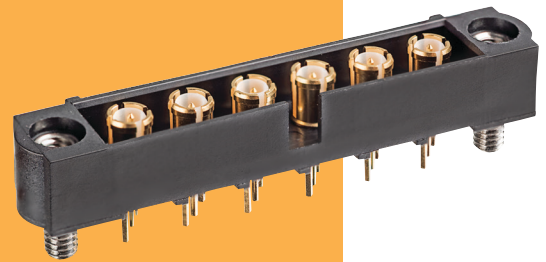

VERTICAL

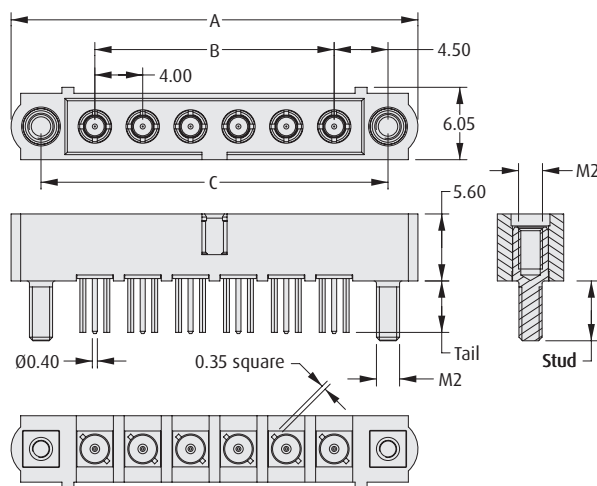

CALCULATION

A	$B + 14$
B	$(\text{No. of Coax contacts} - 1) \times 4$
C	$B + 9$

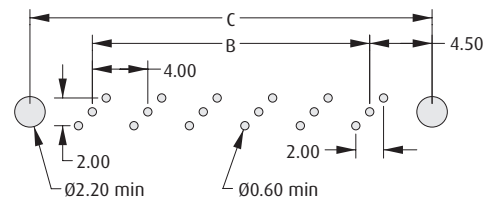

Recommended PCB Board Pattern

HOW TO ORDER

M80 - MV 3XX MX - XX

TYPE	
311M2	3mm Tail with 3.5mm Board Mount Stud
312M3	4.5mm Tail with 5mm Board Mount Stud

NO. OF COAX CONTACTS
02, 04, 06, 08

REQUIRED HARDWARE

Order separately from connector

Slotted Board Mount Nut

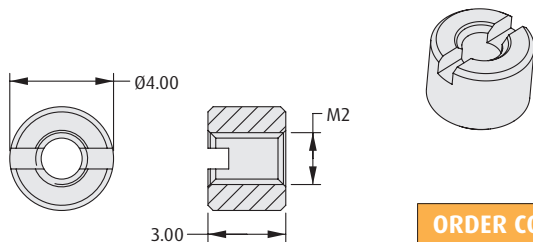

ORDER CODE
M80-2130000B

Hexagonal Board Mount Nut

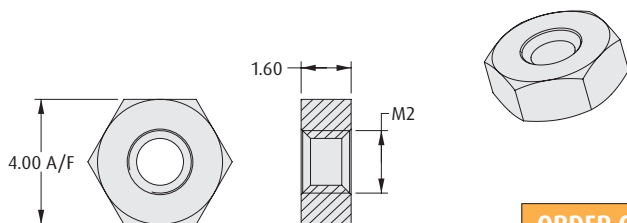

ORDER CODE
M80-2430000B

All dimensions in mm.

Datamate Coax Connectors

Plug (Male) Horizontal PC Tail

- ❖ Stocked coax connectors in horizontal orientation, with board-mount jackscrews for added security.
- ❖ 6GHz, 50Ω Coax contacts.
- ❖ Choice to suit two PCB thicknesses.
- ❖ Order board mount bolts separately.

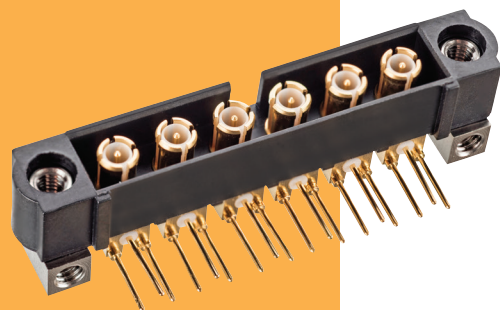

HORIZONTAL

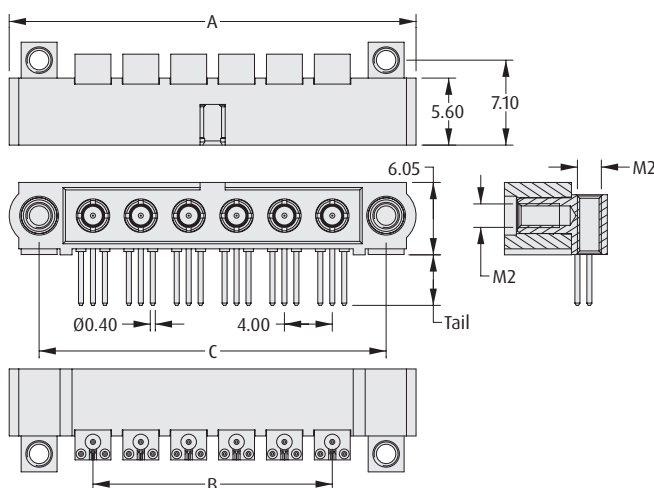

CALCULATION

A	$B + 14$
B	$(\text{No. of Coax contacts} - 1) \times 4$
C	$B + 9$

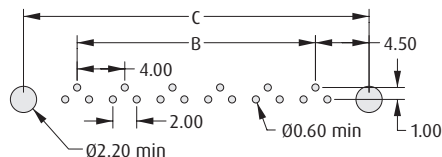

Recommended PCB Board Pattern

HOW TO ORDER

M80 - MH 3XX M5 - XX

TYPE	
313	3mm PC Tail
314	4.5mm PC Tail

NO. OF COAX CONTACTS
02, 04, 06, 08

REQUIRED HARDWARE

Order separately from connector

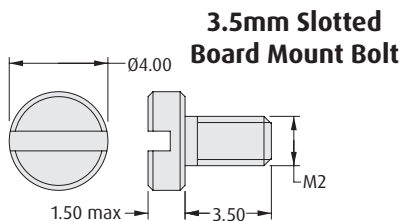

ORDER CODE
M80-2260000B

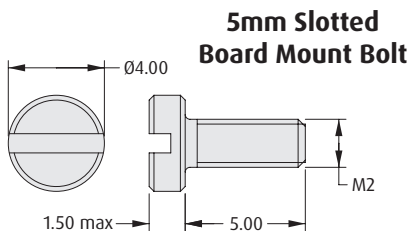

ORDER CODE
M80-2270000B

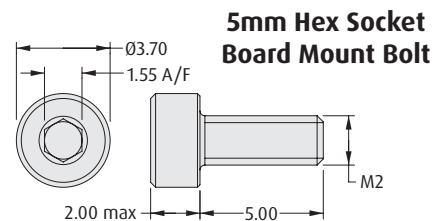

ORDER CODE
M80-2320000B

All dimensions in mm.

Datamate Mix-Tek Connectors

Metal Backshell Accessories

- ❖ Metal Backshells that can be used with any female cable connector (up to 12AWG), or male connectors with board mount jackscrews.
- ❖ Female backshells come with jackscrews - any existing jackscrews can be removed by removing the e-clip.
- ❖ Suitable for new designs, or in-production addition to enhance existing designs.



DATAMATE MIX-TEK

PART NUMBERING SYSTEM

M80 - 9 XX XX 02

SERIES CODE

FINISH

02 Nickel

TYPE

06	Male
45	Female with Slotted Jackscrews
46	Female with Hex Socket Jackscrews

EQUIVALENT NO. OF SIGNAL CONTACTS	NO. OF POWER ONLY OR COAX ONLY CONTACTS	NO. OF CONTACTS IN POWER/SIGNAL COMBINATION
08	2 contacts	-
10	-	2 Power, 2 Signal
12	3 contacts	2 Power, 4 Signal
14	-	2 Power, 6 Signal
16	4 contacts	2 Power, 8 Signal
18	-	4 Power, 2 Signal
20	5 contacts	2 Power, 12 Signal or 4 Power, 4 Signal
22	-	4 Power, 6 Signal
24	6 contacts	4 Power, 8 Signal
28	7 contacts	4 Power, 12 Signal
32	8 contacts	-

All dimensions in mm.

Datamate Mix-Tek Connectors

Female Metal Backshell

- ❖ Supplied as an accessory kit, including metal backshell, e-clips and the applicable jackscrews.
- ❖ To be used with the appropriate size of Female Cable connector kit without jackscrews (existing jackscrews can be removed).
- ❖ Gives 360 degree shielding when used with conductive braid and mated to a compatible male connector with metal backshell.
- ❖ Instruction sheets available at www.harwin.com/instructions.



FEMALE		CALCULATION						
		A	$B + 16.2$					
		B	Equivalent no. of contacts - 2					
		C	$B + 7$					
		D	$B + 0.8$					
E-CLIP TOOL		BAND-IT TIE						
❖ For assembling E-Clips supplied with kit. <table border="1"> <tr><td>ORDER CODE</td></tr> <tr><td>Z80-300</td></tr> </table>		ORDER CODE	Z80-300	❖ For fixing braid to rear collar (requires Tie Dex II A30199 Micro Band tool). <table border="1"> <tr><td>ORDER CODE</td></tr> <tr><td>M80-9470000</td></tr> </table>		ORDER CODE	M80-9470000	
ORDER CODE								
Z80-300								
ORDER CODE								
M80-9470000								
HOW TO ORDER								
M80 - 94 X XX 02								
<table border="1"> <tr><td>SERIES CODE</td></tr> <tr><td>M80 - 94</td></tr> </table>		SERIES CODE	M80 - 94	<table border="1"> <tr><td>FINISH</td></tr> <tr><td>02 Nickel</td></tr> </table>		FINISH	02 Nickel	
SERIES CODE								
M80 - 94								
FINISH								
02 Nickel								
<table border="1"> <tr><td>TYPE</td></tr> <tr><td>5 With Slotted Jackscrews</td></tr> <tr><td>6 With Hex Socket Jackscrews</td></tr> </table>		TYPE	5 With Slotted Jackscrews	6 With Hex Socket Jackscrews	<table border="1"> <tr><td>EQUIVALENT NO. OF SIGNAL CONTACTS</td></tr> <tr><td>08, 10, 12, 14, 16, 18, 20, 22, 24, 28, 32</td></tr> </table>		EQUIVALENT NO. OF SIGNAL CONTACTS	08, 10, 12, 14, 16, 18, 20, 22, 24, 28, 32
TYPE								
5 With Slotted Jackscrews								
6 With Hex Socket Jackscrews								
EQUIVALENT NO. OF SIGNAL CONTACTS								
08, 10, 12, 14, 16, 18, 20, 22, 24, 28, 32								

All dimensions in mm.

Datamate Mix-Tek Connectors

Male Metal Backshell

- ❖ Supplied as an accessory, to be used with existing male connectors.
- ❖ Can be fitted to either male vertical PCB connectors with board mount, or male cable connectors with panel mount jackscrews.
- ❖ Gives 360 degree shielding when mounted to a conductive panel and mated to a compatible female connector with metal backshell.



DATAMATE MIX-TEK

MALE		CALCULATION	
A	$B + 13.7$	B	Equivalent no. of contacts - 2
C	$B + 7$	D	$B + 2.8$

HOW TO ORDER

M80 - 906 XX 02

SERIES CODE	FINISH
	02 Nickel

EQUIVALENT NO. OF SIGNAL CONTACTS
08, 10, 12, 14, 16, 18, 20, 22, 24, 28, 32

All dimensions in mm.

Datamate J-Tek Specification

Materials

Mouldings:	Glass-filled thermoplastic UL94V-0
Female contacts	
Standard J-Tek:	Brass shell, with Beryllium Copper inner contact
T-Contact:	Beryllium Copper
Trio-Tek:	Beryllium Copper
Male contacts:	Copper alloy
Finish:	See individual pages

Electrical

Current - Standard J-Tek, Trio-Tek

Individual contacts in isolation:	3.3A max (at 25°C)
	2.6A max (at 85°C)
All contacts simultaneously:	3.0A max (at 25°C)
	2.2A max (at 85°C)

Current - T-Contact

Individual contacts in isolation:	8.5A max (at 25°C)
	6.5A max (at 85°C)
All contacts simultaneously:	3.5A max (at 25°C)
	2.6A max (at 85°C)

Working voltage

At sea level 1013 mbar:	800V DC or AC peak
-------------------------	--------------------

Voltage proof

At sea level 1013 mbar:	1,200V DC or AC peak
-------------------------	----------------------

Contact resistance

Initial:	20mΩ max
After conditioning:	25mΩ max

Insulation resistance

Initial:	1,000MΩ min
After conditioning:	100MΩ min

Mechanical

Durability

Standard J-Tek:	500 operations
T-Contact:	1,000 operations
Trio-Tek:	400 operations

Insertion force (max)

Standard J-Tek:	2.8N
T-Contact:	4.0N
Trio-Tek:	2.8N

Withdrawal force (min)

Standard J-Tek:	0.2N
T-Contact:	0.5N
Trio-Tek:	0.2N

Signal crimp accommodation:

22 AWG to 32 AWG
BS 3G 210 Type A, MIL-W-16878

Environmental

Environmental classification: 55/125/56 days at 95% RH

Operational temperature: -55°C to +125°C

*Vibration sensitivity

Standard J-Tek, Trio-Tek: 10Hz to 2000Hz, 0.75mm, 98m/s² (10G), duration 6 hours

T-Contact: 10Hz to 2000Hz, 0.75mm, 390m/s² (40G), duration 6 hours

*Bump severity:

390m/s² (40G), 4000 ±10 bumps

*Shock severity:

981m/s² (100G) for 6ms

*Acceleration severity:

490m/s² (50G)

* Tested with connectors with Jackscrews.

Pin Numbering

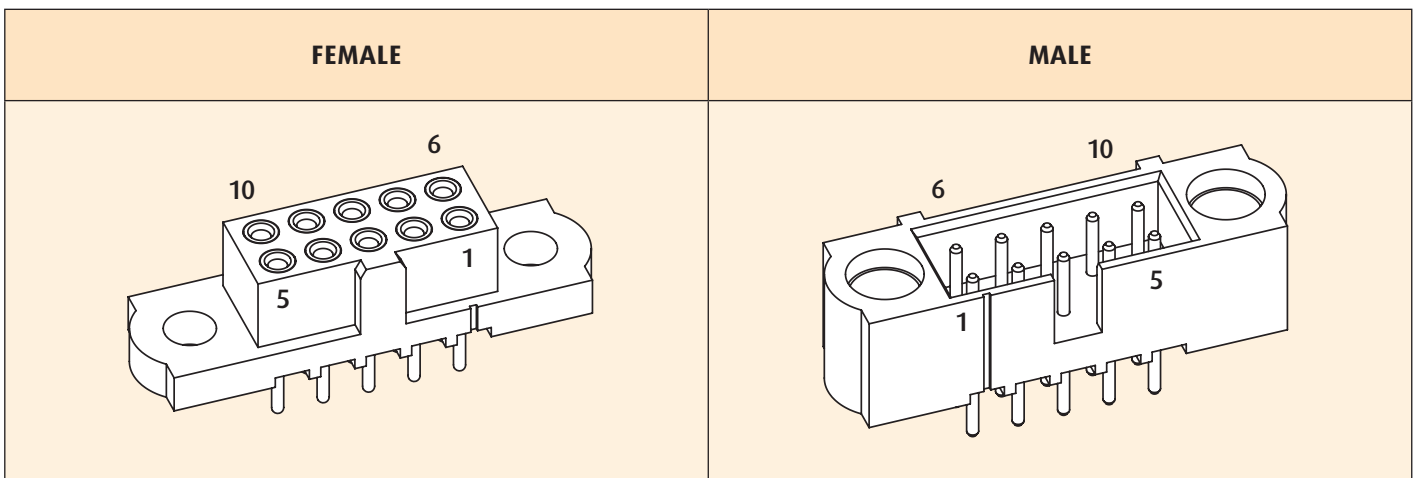

All dimensions in mm.

Datamate J-Tek Mating Profiles

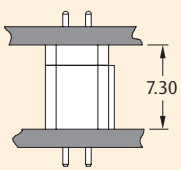
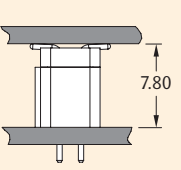
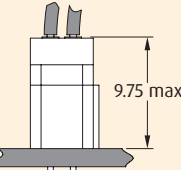
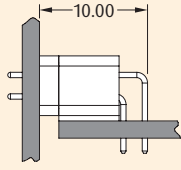
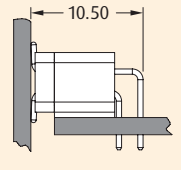
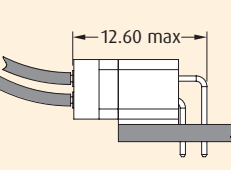
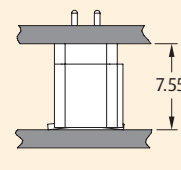
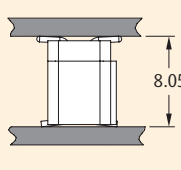
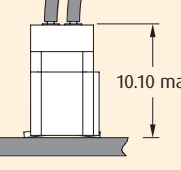
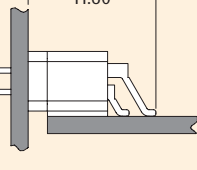
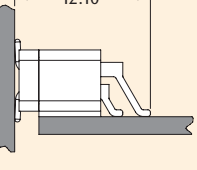
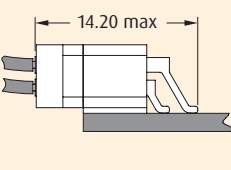
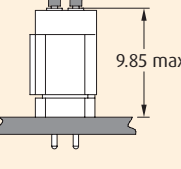
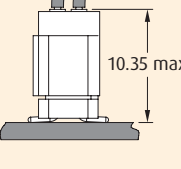
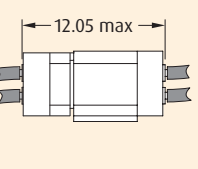
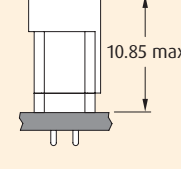
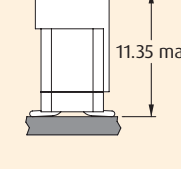
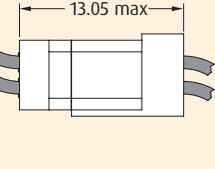
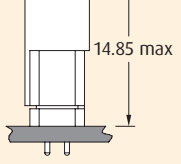
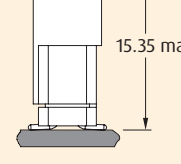
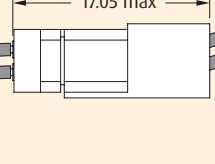
		FEMALE		
		VERTICAL PC TAIL	VERTICAL SMT	CRIMP
MALE	VERTICAL PC TAIL			
	HORIZONTAL PC TAIL			
	VERTICAL SMT			
	HORIZONTAL SMT			
	CRIMP			
	CRIMP 1mm EXTENDED WALL			
	CRIMP 5mm EXTENDED WALL			

All dimensions in mm.

Mating Profiles

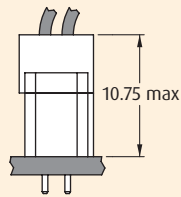
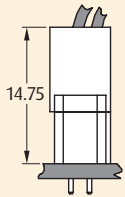
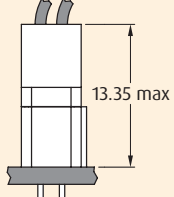
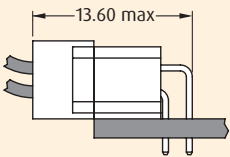
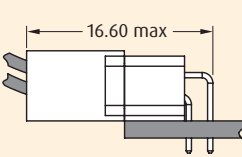
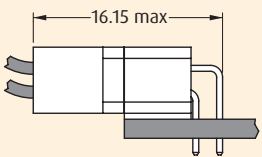
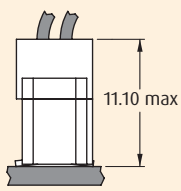
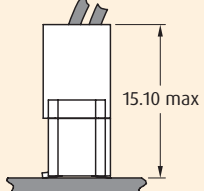
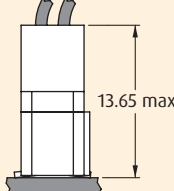
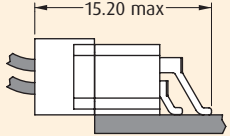
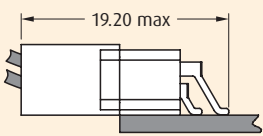
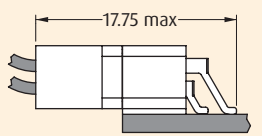
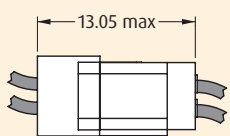
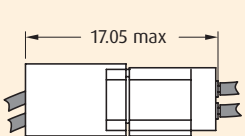
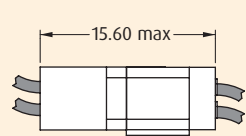
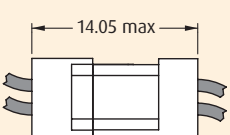
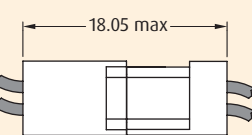
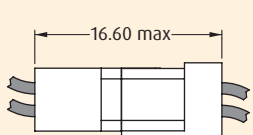
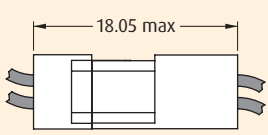
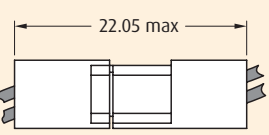
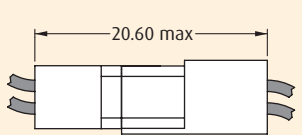
		FEMALE		
		CRIMP 1mm EXTENDED WALL	CRIMP 5mm EXTENDED WALL	CRIMP TRIO-TEK
MALE	VERTICAL PC TAIL			
	HORIZONTAL PC TAIL			
	VERTICAL SMT			
	HORIZONTAL SMT			
	CRIMP			
	CRIMP 1mm EXTENDED WALL			
	CRIMP 5mm EXTENDED WALL			

All dimensions in mm.

Datamate J-Tek Connectors

Female Vertical PC Tail

- ❖ Fully shrouded contacts.
- ❖ Polarised mouldings.
- ❖ Mates with all Datamate J-Tek male connectors with compatible jackscrews.

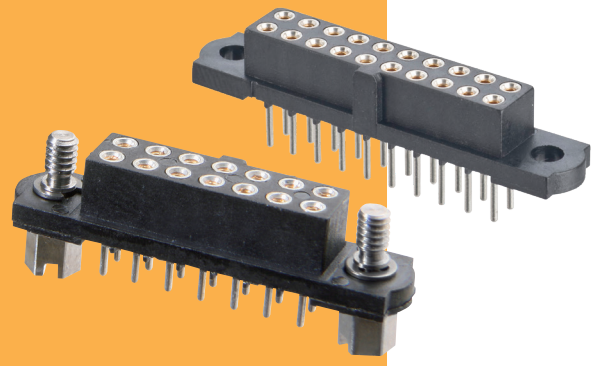

DATAMATE J-TEK

WITHOUT JACKSCREWS

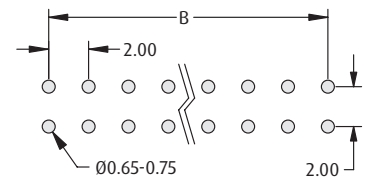
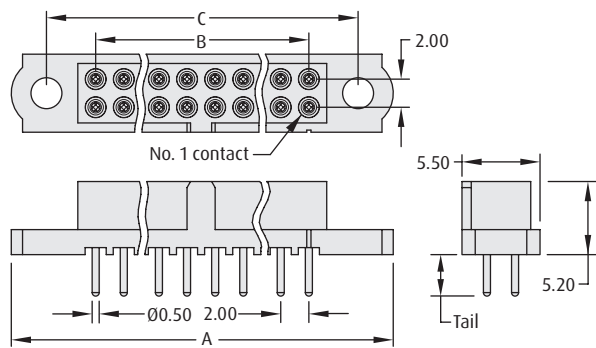

Recommended PC Board Pattern

CALCULATION

A	B + 12
B	Total no. of contacts - 2
C	B + 7

WITH JACKSCREWS

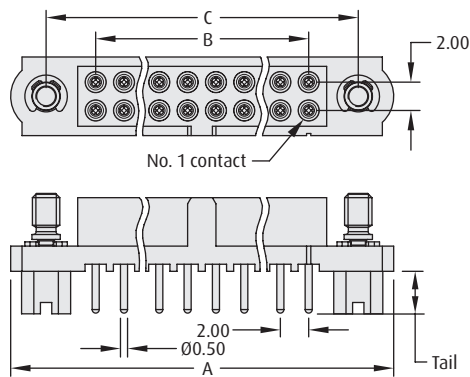

Hex Slotted Jackscrew

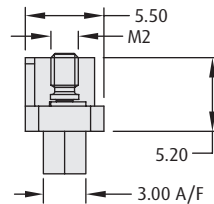

Hex Socket Jackscrew

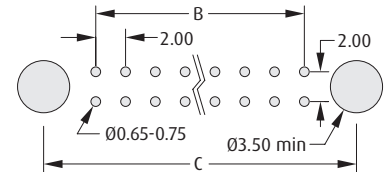
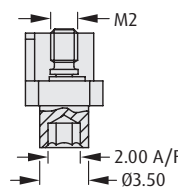

Recommended PC Board Pattern

HOW TO ORDER

M80 - 4 X X XX XX

SERIES CODE

0	With Hex Slotted Jackscrews
1	Without Jackscrews
2	With Hex Socket Jackscrews

0	3mm Tails
1	4.5mm Tails

FINISH

05	Gold
42	Gold + Tin

TOTAL NO. OF CONTACTS

04, 06, 08, 10, 12, 14, 20, 26, 34, 42, 50

All dimensions in mm.

Datamate J-Tek Connectors

DATAMATE J-TEK

Female Vertical PC Tail Guide Pin, 101Lok

- Guide pin style includes board mount fixing, and mates with Datamate J-Tek male connectors with compatible jackscrews.
- 101Lok fixing gives secure, fast and simple mating; no special tooling required. Just a simple 101-degree turn is required to fix the connectors together.
- 101Lok style mates with Datamate J-Tek male connectors with compatible 101Lok fixings.

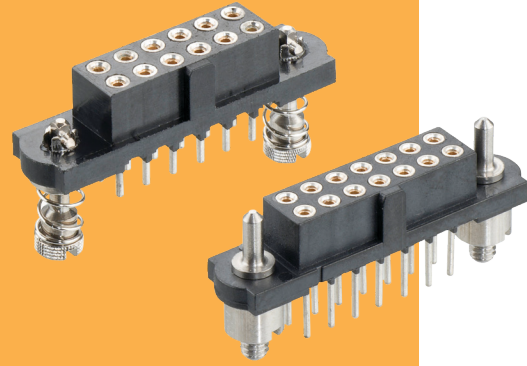

GUIDE PIN JACKSCREWS

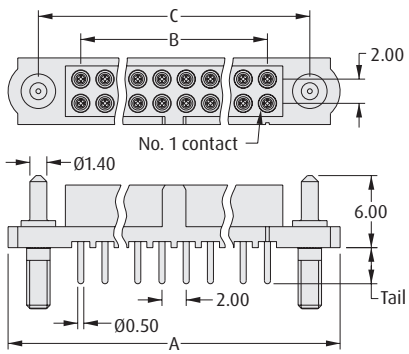

Board Mount Nut, 2 per connector

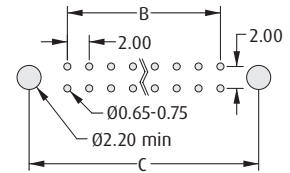
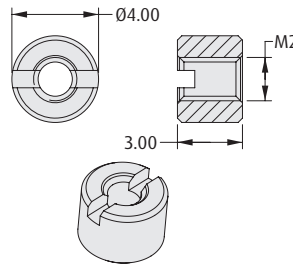

Recommended PC Board Pattern

CALCULATION

A	B + 12
B	Total no. of contacts - 2
C	B + 7

101LOK

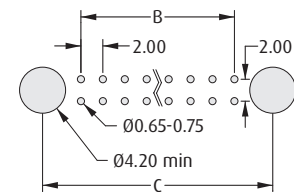
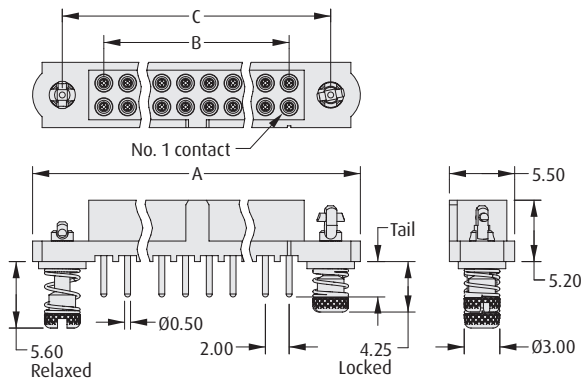

Recommended PC Board Pattern

HOW TO ORDER

M80 - 4 TX XX XX FX

SERIES CODE

TYPE

T1	3mm Tails
T2	4.5mm Tails

TOTAL NO. OF CONTACTS

04, 06, 08, 10, 12, 14, 20, 26, 34, 42, 50

JACKSCREW

F3	Guide Pin
FC	101Lok

FINISH

05	Gold
42	Gold + Tin

All dimensions in mm.

Datamate J-Tek Connectors

Female Vertical PC Tail Reverse Fix

- ❖ Fully shrouded contacts.
- ❖ Polarised mouldings.
- ❖ Includes board mount fixing.
- ❖ Mates with male Datamate J-Tek connectors with compatible Reverse Fix jackscrews.



DATAMATE J-TEK

REVERSE FIX

CALCULATION

A	$B + 12$
B	Total no. of contacts - 2
C	$B + 7$

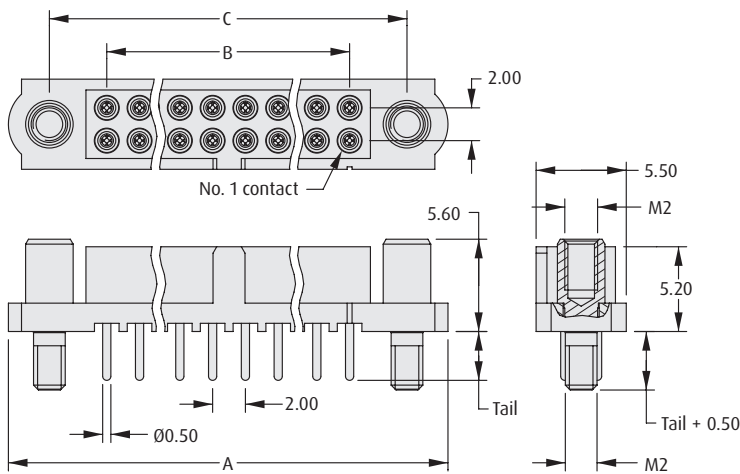

Board Mount Nut, 2 per connector

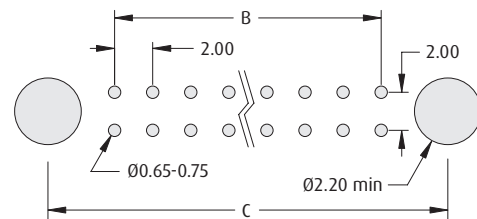
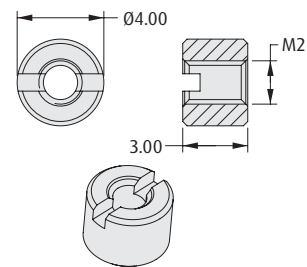

Recommended PC Board Pattern

HOW TO ORDER

M80 - 40 X XX XX

SERIES CODE

TYPE

5	3mm Tails
6	4.5mm Tails

FINISH

05	Gold
42	Gold + Tin

TOTAL NO. OF CONTACTS

04, 06, 08, 10, 12, 14, 20, 26, 34, 42, 50

All dimensions in mm.

Datamate J-Tek Connectors

Female Vertical Surface Mount

- Mates with all Datamate J-Tek male connectors with compatible jackscrews.
- Gull wing SMT tails simplify inspection process.
- Optional pick and place cap.
- Contact datamate@harwin.com for tape and reel options.

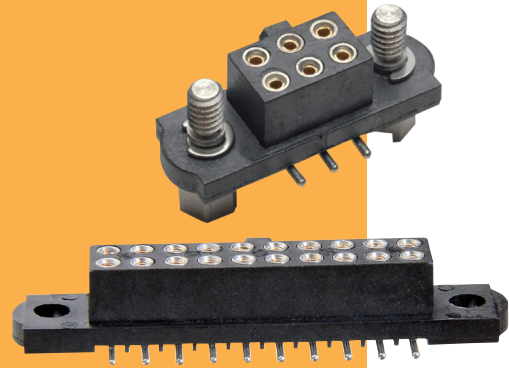

DATAMATE J-TEK

WITHOUT JACKSCREWS

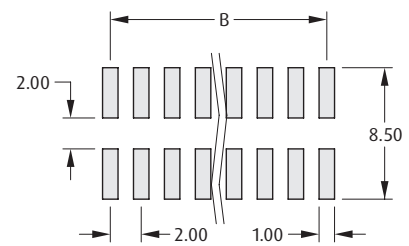
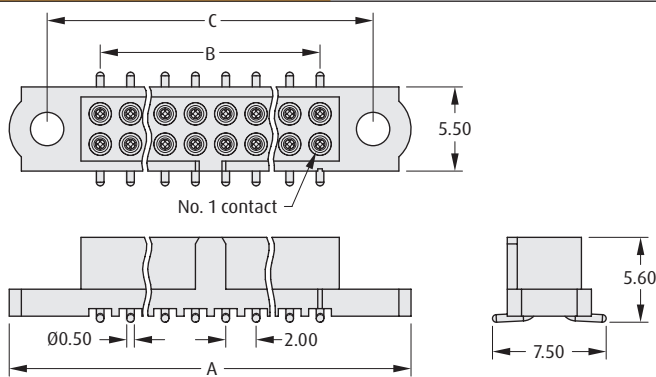

Recommended PC Board Pattern

CALCULATION

A	$B + 12$
B	Total no. of contacts - 2
C	$B + 7$

WITH JACKSCREWS

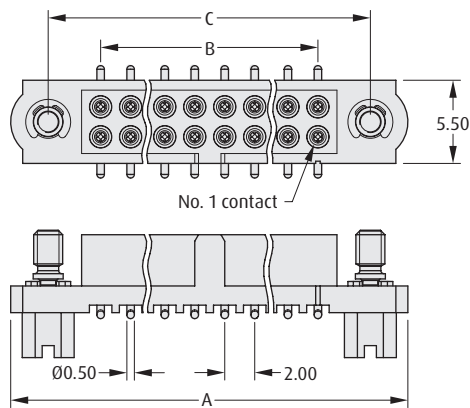

Hex Slotted Jackscrew

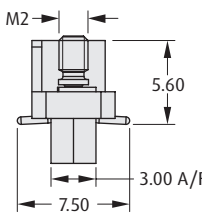

Hex Socket Jackscrew

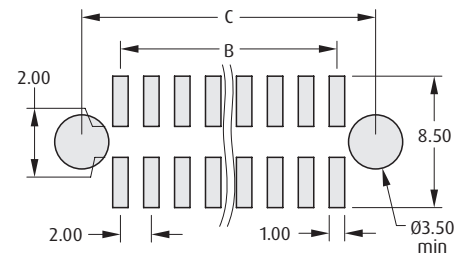
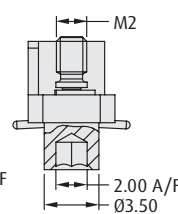

Recommended PC Board Pattern

HOW TO ORDER

M80 - 4 X 2 XX XX P

SERIES CODE

TYPE

0	With Hex Slotted Jackscrews
1	Without Jackscrews
2	With Hex Socket Jackscrews

TOTAL NO. OF CONTACTS

04, 06, 08, 10, 12, 14, 20, 26, 34, 42, 50

PICK AND PLACE CAP

BLANK	No cap
P	Pick and place cap

FINISH

05	Gold
42	Gold + Tin

All dimensions in mm.

Datamate J-Tek Connectors

Female Vertical Surface Mount Guide Pin, 101Lok

- Guide pin style includes board mount fixing, and mates with Datamate J-Tek male connectors with compatible jackscrews.
- 101Lok fixing gives secure, fast and simple mating; no special tooling required. Just a simple 101-degree turn is required to fix the connectors together.
- 101Lok style mates with Datamate J-Tek male connectors with compatible 101Lok fixings.

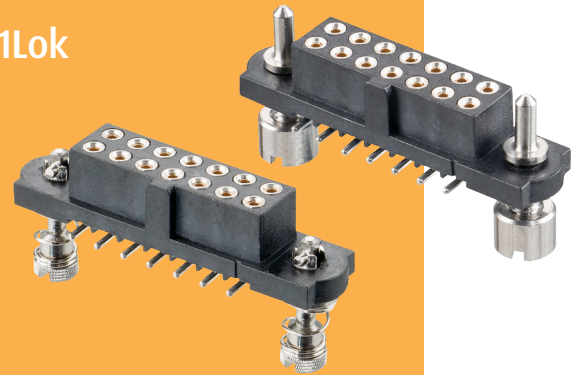

DATAMATE J-TEK

GUIDE PIN JACKSCREWS

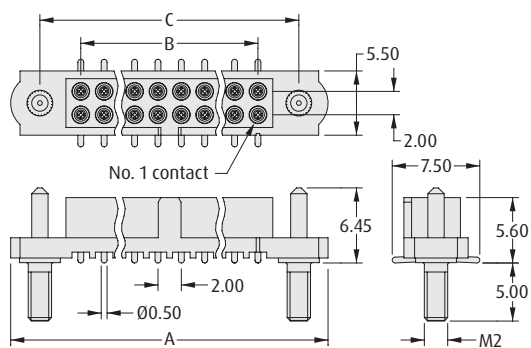

Board Mount Nut, 2 per connector

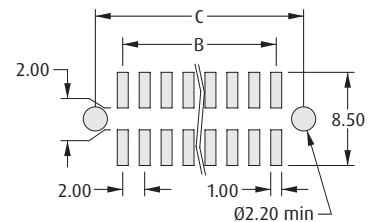
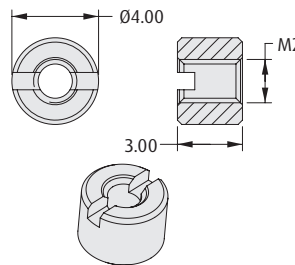

Recommended PC Board Pattern

CALCULATION

A	B + 12
B	Total no. of contacts - 2
C	B + 7

101LOK

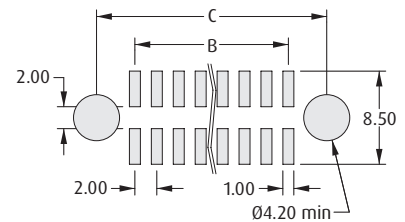
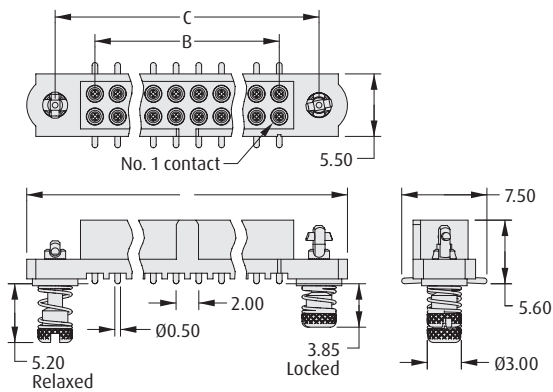

Recommended PC Board Pattern

HOW TO ORDER

M80 - 4S1 XX XX FX

SERIES CODE

TOTAL NO. OF CONTACTS

04, 06, 08, 10, 12, 14, 20, 26, 34, 42, 50

JACKSCREW

F3	Guide Pin
FC	101Lok

FINISH

05	Gold
42	Gold + Tin

All dimensions in mm.

Datamate J-Tek Connectors

Female Vertical Surface Mount Reverse Fix

- Fully shrouded contacts.
- Polarised mouldings.
- Includes Board Mount fixing.
- Mates with male Datamate J-Tek connectors with compatible Reverse Fix jackscrews.

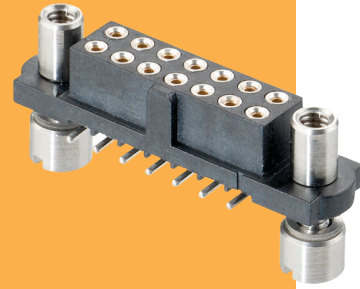

DATAMATE J-TEK

REVERSE FIX

CALCULATION

A	$B + 12$
B	Total no. of contacts - 2
C	$B + 7$

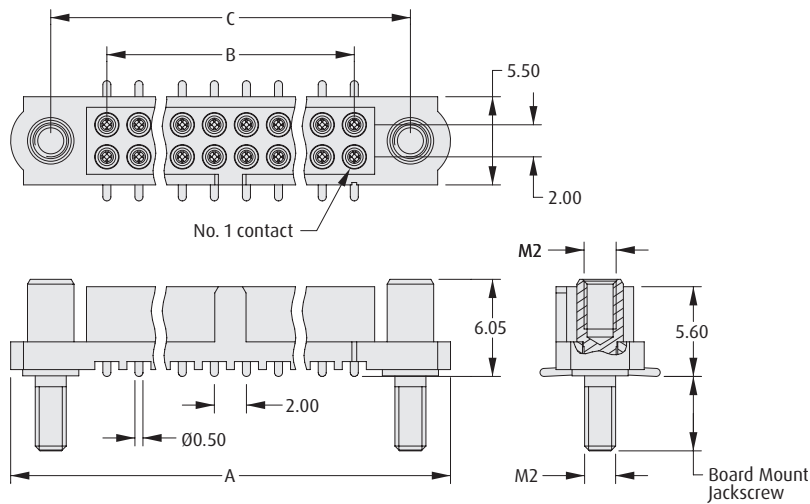

Board Mount Nut, 2 per connector

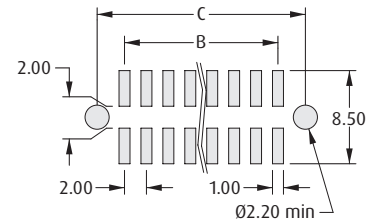
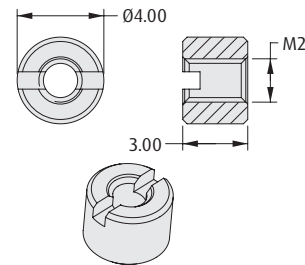

Recommended PC Board Pattern

HOW TO ORDER

M80 - 4S1 XX XX FX

SERIES CODE

TOTAL NO. OF CONTACTS

04, 06, 08, 10, 12, 14, 20, 26, 34, 42, 50

TYPE

F8	3.5mm Board Mount Jackscrew
F9	5mm Board Mount Jackscrew

FINISH

05	Gold
42	Gold + Tin

All dimensions in mm.

Datamate J-Tek Connectors

Female Crimp Kit

- ❖ Part numbers are for a complete kit of a housing and the applicable number of contacts.
- ❖ Jackscrews are assembled where specified.
- ❖ Crimp contacts are rear insertable.
- ❖ Version also available for 28 – 32 AWG cable – see the following page.
- ❖ Spare contacts are available.

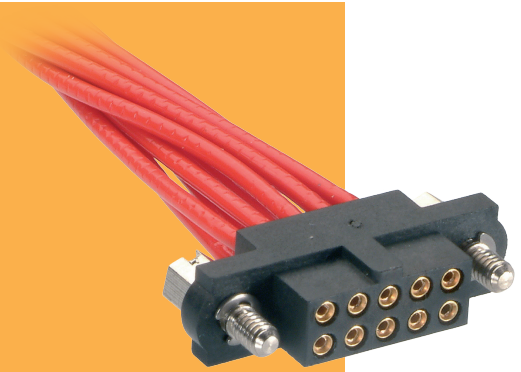

DATAMATE J-TEK

WITHOUT JACKSCREWS		WITH JACKSCREWS																	
		<table border="1"> <thead> <tr> <th colspan="2">CALCULATION</th> </tr> </thead> <tbody> <tr> <td>A</td> <td>B + 12</td> </tr> <tr> <td>B</td> <td>Total no. of contacts - 2</td> </tr> <tr> <td>C</td> <td>B + 7</td> </tr> </tbody> </table>		CALCULATION		A	B + 12	B	Total no. of contacts - 2	C	B + 7								
CALCULATION																			
A	B + 12																		
B	Total no. of contacts - 2																		
C	B + 7																		
		<p>Hex Slotted Jackscrew Hex Socket Jackscrew</p>																	
TOOLS		WIRE STRIPPING DETAILS																	
<p>Recommended Crimp Tool – M22520/2-01 Positioner – T5747 Contact Insertion/Removal Tool – Z80-280</p> <ul style="list-style-type: none"> ❖ Spare and pre-cabled contacts shown on following pages. ❖ Instruction sheets available at www.harwin.com/instructions. 																			
HOW TO ORDER																			
<p>M80 - 4XX XX XX</p>																			
<table border="1"> <thead> <tr> <th colspan="2">SERIES CODE</th> </tr> <tr> <th>LARGE BORE (22 AWG)</th> <th>SMALL BORE (24-28 AWG)</th> </tr> </thead> <tbody> <tr> <td>470</td> <td>471</td> </tr> <tr> <td>460</td> <td>461</td> </tr> <tr> <td>480</td> <td>481</td> </tr> </tbody> </table>		SERIES CODE		LARGE BORE (22 AWG)	SMALL BORE (24-28 AWG)	470	471	460	461	480	481	<table border="1"> <thead> <tr> <th colspan="2">FINISH</th> </tr> </thead> <tbody> <tr> <td>05</td> <td>Gold</td> </tr> <tr> <td>42</td> <td>Gold + Tin</td> </tr> </tbody> </table>		FINISH		05	Gold	42	Gold + Tin
SERIES CODE																			
LARGE BORE (22 AWG)	SMALL BORE (24-28 AWG)																		
470	471																		
460	461																		
480	481																		
FINISH																			
05	Gold																		
42	Gold + Tin																		
<table border="1"> <thead> <tr> <th>LARGE BORE (22 AWG)</th> <th>SMALL BORE (24-28 AWG)</th> <th></th> </tr> </thead> <tbody> <tr> <td>470</td> <td>471</td> <td>Without Jackscrews</td> </tr> <tr> <td>460</td> <td>461</td> <td>With Hex Slotted Jackscrews</td> </tr> <tr> <td>480</td> <td>481</td> <td>With Hex Socket Jackscrews</td> </tr> </tbody> </table>		LARGE BORE (22 AWG)	SMALL BORE (24-28 AWG)		470	471	Without Jackscrews	460	461	With Hex Slotted Jackscrews	480	481	With Hex Socket Jackscrews	<table border="1"> <thead> <tr> <th>TOTAL NO. OF CONTACTS</th> </tr> </thead> <tbody> <tr> <td>04, 06, 08, 10, 12, 14, 20, 26, 34, 42, 50</td> </tr> </tbody> </table>		TOTAL NO. OF CONTACTS	04, 06, 08, 10, 12, 14, 20, 26, 34, 42, 50		
LARGE BORE (22 AWG)	SMALL BORE (24-28 AWG)																		
470	471	Without Jackscrews																	
460	461	With Hex Slotted Jackscrews																	
480	481	With Hex Socket Jackscrews																	
TOTAL NO. OF CONTACTS																			
04, 06, 08, 10, 12, 14, 20, 26, 34, 42, 50																			

All dimensions in mm.

Datamate J-Tek Connectors

Female Crimp Kit - Extra Small Bore

- Part numbers are for a complete kit of a housing and the applicable number of contacts.
- Jackscrews are assembled where specified.
- Crimp contacts are rear insertable.
- Versions also available for 22 - 28 AWG cable - see the previous page.
- Spare contacts are available.

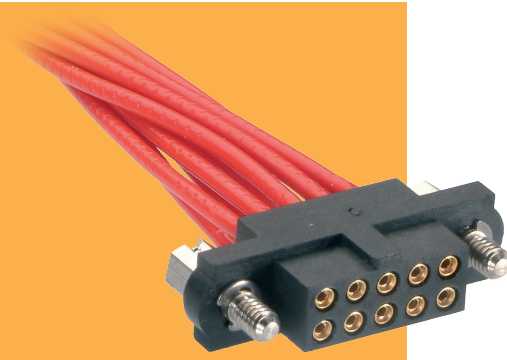

DATAMATE J-TEK

WITHOUT JACKSCREWS		WITH JACKSCREWS							
<p>Calculation</p> <table border="1"> <tr> <td>A</td> <td>B + 12</td> </tr> <tr> <td>B</td> <td>Total no. of contacts - 2</td> </tr> <tr> <td>C</td> <td>B + 7</td> </tr> </table>		A	B + 12	B	Total no. of contacts - 2	C	B + 7	<p>Hex Slotted Jackscrew</p> <p>Hex Socket Jackscrew</p>	
A	B + 12								
B	Total no. of contacts - 2								
C	B + 7								
TOOLS		WIRE STRIPPING DETAILS							
<p>Recommended Crimp Tool - M22520/2-01</p> <p>Positioner - T5747</p> <p>Contact Insertion/Removal Tool - Z80-280</p> <ul style="list-style-type: none"> Spare and pre-cabled contacts shown on following pages. Instruction sheets available at www.harwin.com/instructions. 									
HOW TO ORDER									
M80 - 4 E1 XX XX FX									
SERIES CODE		JACKSCREW							
TYPE		00	Without Jackscrews						
E1	Extra Small Bore 28-32 AWG	F1	With Hex Slotted Jackscrews						
TOTAL NO. OF CONTACTS		F2	With Hex Socket Jackscrews						
04, 06, 08, 10, 12, 14, 20, 26, 34, 42, 50		FINISH							
		05	Gold						
		42	Gold + Tin						

All dimensions in mm.

Datamate J-Tek Connectors

Female Crimp Kit - Guide Pin, 101Lok

- Guide pin style includes board mount fixing.
- 101Lok fixing gives secure, fast and simple mating; no special tooling required. Just a simple 101-degree turn is required to fix the connectors together.
- Connectors mate with Datamate J-Tek male connectors with applicable jackscrews or 101Lok fixings.
- Part numbers are for a complete kit of a housing and the applicable number of contacts.

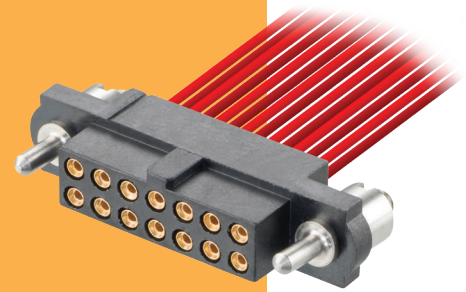

DATAMATE J-TEK

GUIDE PIN JACKSCREWS	101LOK																						
<p>Board Mount Nut, 2 per connector</p> <table border="1" data-bbox="657 1075 966 1234"> <thead> <tr> <th colspan="2">CALCULATION</th> </tr> </thead> <tbody> <tr> <td>A</td> <td>B + 12</td> </tr> <tr> <td>B</td> <td>Total no. of contacts - 2</td> </tr> <tr> <td>C</td> <td>B + 7</td> </tr> </tbody> </table>	CALCULATION		A	B + 12	B	Total no. of contacts - 2	C	B + 7															
CALCULATION																							
A	B + 12																						
B	Total no. of contacts - 2																						
C	B + 7																						
<p>TOOLS</p> <p>Recommended Crimp Tool - M22520/2-01 Positioner - T5747 Contact Insertion/Removal Tool - Z80-280</p> <ul style="list-style-type: none"> Spare and pre-cabled contacts shown on following pages. Instruction sheets available at www.harwin.com/instructions. 	<p>WIRE STRIPPING DETAILS</p>																						
HOW TO ORDER																							
<p style="text-align: center;">M80 - 4 X1 XX XX FX</p> <table border="1" data-bbox="146 1669 516 1894"> <thead> <tr> <th colspan="2">TYPE</th> </tr> </thead> <tbody> <tr> <td>C1</td> <td>Small Bore (24-28 AWG)</td> </tr> <tr> <td>D1</td> <td>Large Bore (22 AWG)</td> </tr> <tr> <td>E1</td> <td>Extra Small Bore (28-32 AWG)</td> </tr> </tbody> </table> <table border="1" data-bbox="669 1810 1079 1894"> <thead> <tr> <th>TOTAL NO. OF CONTACTS</th> </tr> </thead> <tbody> <tr> <td>04, 06, 08, 10, 12, 14, 20, 26, 34, 42, 50</td> </tr> </tbody> </table> <table border="1" data-bbox="1274 1621 1474 1738"> <thead> <tr> <th colspan="2">JACKSCREW</th> </tr> </thead> <tbody> <tr> <td>F3</td> <td>Guide Pin</td> </tr> <tr> <td>FC</td> <td>101Lok</td> </tr> </tbody> </table> <table border="1" data-bbox="1274 1780 1474 1894"> <thead> <tr> <th colspan="2">FINISH</th> </tr> </thead> <tbody> <tr> <td>05</td> <td>Gold</td> </tr> <tr> <td>42</td> <td>Gold + Tin</td> </tr> </tbody> </table>		TYPE		C1	Small Bore (24-28 AWG)	D1	Large Bore (22 AWG)	E1	Extra Small Bore (28-32 AWG)	TOTAL NO. OF CONTACTS	04, 06, 08, 10, 12, 14, 20, 26, 34, 42, 50	JACKSCREW		F3	Guide Pin	FC	101Lok	FINISH		05	Gold	42	Gold + Tin
TYPE																							
C1	Small Bore (24-28 AWG)																						
D1	Large Bore (22 AWG)																						
E1	Extra Small Bore (28-32 AWG)																						
TOTAL NO. OF CONTACTS																							
04, 06, 08, 10, 12, 14, 20, 26, 34, 42, 50																							
JACKSCREW																							
F3	Guide Pin																						
FC	101Lok																						
FINISH																							
05	Gold																						
42	Gold + Tin																						

All dimensions in mm.

Datamate J-Tek Connectors

Female Crimp Kit - Reverse Fix

- ❖ Allows for further flexibility in system design.
- ❖ Crimp contacts supplied loose and are inserted from rear.
- ❖ Part numbers are for a complete kit of a housing and the applicable number of contacts.
- ❖ Jackscrews are assembled.
- ❖ Mates with male Datamate J-Tek connectors with compatible Reverse Fix jackscrews.

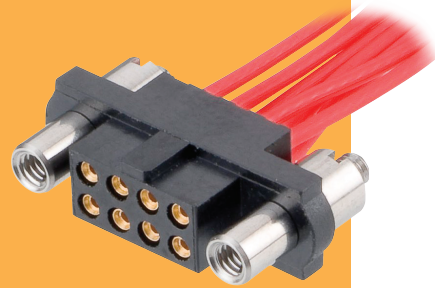

WITH JACKSCREWS	CALCULATION	WIRE STRIPPING DETAILS																																								
<p>No. 1 contact</p> <p>M2</p> <p>7.55</p> <p>Board Mount Jackscrew</p> <p>M2</p> <p>04.00</p> <p>M2</p> <p>3.00</p> <p>Board Mount Nut, 2 per connector</p>	<table border="1"> <tr> <td>A</td> <td>B + 12</td> </tr> <tr> <td>B</td> <td>Total no. of contacts - 2</td> </tr> <tr> <td>C</td> <td>B + 7</td> </tr> </table>	A	B + 12	B	Total no. of contacts - 2	C	B + 7	<p>Ø1.10 max for Small & Large Bore Ø0.75 max for Extra Small Bore</p> <p>2.00</p>																																		
	A	B + 12																																								
B	Total no. of contacts - 2																																									
C	B + 7																																									
		<table border="1"> <thead> <tr> <th colspan="2" style="background-color: #f4a460;">TOOLS</th> </tr> </thead> <tbody> <tr> <td colspan="2">Recommended Crimp Tool - M22520/2-01</td> </tr> <tr> <td colspan="2">Positioner - T5747</td> </tr> <tr> <td colspan="2">Contact Insertion/Removal Tool - Z80-280</td> </tr> <tr> <td colspan="2">❖ Spare and pre-cabled contacts shown on following pages.</td> </tr> <tr> <td colspan="2">❖ Instruction sheets available at www.harwin.com/instructions.</td> </tr> </tbody> </table>	TOOLS		Recommended Crimp Tool - M22520/2-01		Positioner - T5747		Contact Insertion/Removal Tool - Z80-280		❖ Spare and pre-cabled contacts shown on following pages.		❖ Instruction sheets available at www.harwin.com/instructions .																													
TOOLS																																										
Recommended Crimp Tool - M22520/2-01																																										
Positioner - T5747																																										
Contact Insertion/Removal Tool - Z80-280																																										
❖ Spare and pre-cabled contacts shown on following pages.																																										
❖ Instruction sheets available at www.harwin.com/instructions .																																										
HOW TO ORDER																																										
<p>M80 - 4XX XX XX M80 - 4 X1 XX XX FX</p>																																										
<table border="1"> <thead> <tr> <th colspan="2" style="background-color: #f4a460;">SERIES CODE</th> </tr> </thead> <tbody> <tr> <td>462</td> <td>Large Bore (22 AWG)</td> </tr> <tr> <td>463</td> <td>Small Bore (24-28 AWG)</td> </tr> </tbody> </table> <table border="1"> <thead> <tr> <th colspan="2" style="background-color: #f4a460;">TOTAL NO. OF CONTACTS</th> </tr> </thead> <tbody> <tr> <td colspan="2">04, 06, 08, 10, 12, 14, 20, 26, 34, 42, 50</td> </tr> </tbody> </table> <table border="1"> <thead> <tr> <th colspan="2" style="background-color: #f4a460;">FINISH</th> </tr> </thead> <tbody> <tr> <td>05</td> <td>Gold</td> </tr> <tr> <td>42</td> <td>Gold + Tin</td> </tr> </tbody> </table> <p style="text-align: center;">3.5mm Board Mount Jackscrews only</p>	SERIES CODE		462	Large Bore (22 AWG)	463	Small Bore (24-28 AWG)	TOTAL NO. OF CONTACTS		04, 06, 08, 10, 12, 14, 20, 26, 34, 42, 50		FINISH		05	Gold	42	Gold + Tin	<table border="1"> <thead> <tr> <th colspan="2" style="background-color: #f4a460;">SERIES CODE</th> </tr> </thead> <tbody> <tr> <td>C1</td> <td>Small Bore (24-28 AWG)</td> </tr> <tr> <td>D1</td> <td>Large Bore (22 AWG)</td> </tr> <tr> <td>E1</td> <td>Extra Small Bore (28-32 AWG)</td> </tr> </tbody> </table> <table border="1"> <thead> <tr> <th colspan="2" style="background-color: #f4a460;">TOTAL NO. OF CONTACTS</th> </tr> </thead> <tbody> <tr> <td colspan="2">04, 06, 08, 10, 12, 14, 20, 26, 34, 42, 50</td> </tr> </tbody> </table> <table border="1"> <thead> <tr> <th colspan="2" style="background-color: #f4a460;">FINISH</th> </tr> </thead> <tbody> <tr> <td>05</td> <td>Gold</td> </tr> <tr> <td>42</td> <td>Gold + Tin</td> </tr> </tbody> </table> <table border="1"> <thead> <tr> <th colspan="2" style="background-color: #f4a460;">JACKSCREW</th> </tr> </thead> <tbody> <tr> <td>F8</td> <td>3.5mm Board Mount</td> </tr> <tr> <td>F9</td> <td>5mm Board Mount</td> </tr> </tbody> </table>		SERIES CODE		C1	Small Bore (24-28 AWG)	D1	Large Bore (22 AWG)	E1	Extra Small Bore (28-32 AWG)	TOTAL NO. OF CONTACTS		04, 06, 08, 10, 12, 14, 20, 26, 34, 42, 50		FINISH		05	Gold	42	Gold + Tin	JACKSCREW		F8	3.5mm Board Mount	F9	5mm Board Mount
SERIES CODE																																										
462	Large Bore (22 AWG)																																									
463	Small Bore (24-28 AWG)																																									
TOTAL NO. OF CONTACTS																																										
04, 06, 08, 10, 12, 14, 20, 26, 34, 42, 50																																										
FINISH																																										
05	Gold																																									
42	Gold + Tin																																									
SERIES CODE																																										
C1	Small Bore (24-28 AWG)																																									
D1	Large Bore (22 AWG)																																									
E1	Extra Small Bore (28-32 AWG)																																									
TOTAL NO. OF CONTACTS																																										
04, 06, 08, 10, 12, 14, 20, 26, 34, 42, 50																																										
FINISH																																										
05	Gold																																									
42	Gold + Tin																																									
JACKSCREW																																										
F8	3.5mm Board Mount																																									
F9	5mm Board Mount																																									

All dimensions in mm.

Datamate J-Tek Connectors

Female Crimp Kit - Extended Wall

- ❖ Extended Wall Datamate allows back potting to be performed.
- ❖ Polarised mouldings.
- ❖ Crimp contacts are rear insertable.
- ❖ Large bore 22 AWG, small bore 24 - 28 AWG.
- ❖ Part numbers are for a housing and the equivalent number of contacts.

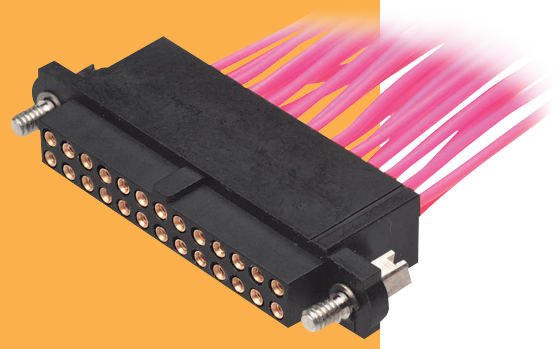

DATAMATE J-TEK

WITHOUT JACKSCREWS	WITH JACKSCREWS																				
<div style="border: 1px solid black; padding: 5px; margin-top: 10px;"> <p style="text-align: center; background-color: #f4a460; color: white; margin: 0;">CALCULATION</p> <table border="1" style="width: 100%; border-collapse: collapse;"> <tr> <td style="background-color: #f4a460; color: white; padding: 2px;">A</td> <td style="padding: 2px;">$B + 12$</td> </tr> <tr> <td style="background-color: #f4a460; color: white; padding: 2px;">B</td> <td style="padding: 2px;">Total no. of contacts - 2</td> </tr> <tr> <td style="background-color: #f4a460; color: white; padding: 2px;">C</td> <td style="padding: 2px;">$B + 7$</td> </tr> </table> </div>	A	$B + 12$	B	Total no. of contacts - 2	C	$B + 7$															
A	$B + 12$																				
B	Total no. of contacts - 2																				
C	$B + 7$																				
TOOLS	WIRE STRIPPING DETAILS																				
<p>Recommended Crimp Tool - M22520/2-01</p> <p>Positioner - T5747</p> <p>Contact Insertion/Removal Tool - Z80-280</p> <ul style="list-style-type: none"> ❖ Spare and pre-cabled contacts shown on following pages. ❖ Instruction sheets available at www.harwin.com/instructions. 																					
HOW TO ORDER																					
<p>M80 - XXX XX XX</p>																					
<div style="border: 1px solid black; padding: 5px; margin-bottom: 10px;"> <p style="background-color: #f4a460; color: white; padding: 2px; margin: 0;">SERIES CODE</p> </div> <table border="1" style="width: 100%; border-collapse: collapse;"> <thead> <tr> <th style="background-color: #f4a460; color: white; padding: 5px;">LARGE BORE (22 AWG)</th> <th style="background-color: #f4a460; color: white; padding: 5px;">SMALL BORE (24-28 AWG)</th> <th style="padding: 5px;"></th> </tr> </thead> <tbody> <tr> <td style="text-align: center; padding: 5px;">475</td> <td style="text-align: center; padding: 5px;">476</td> <td style="padding: 5px;">Without Jackscrews</td> </tr> <tr> <td style="text-align: center; padding: 5px;">465</td> <td style="text-align: center; padding: 5px;">466</td> <td style="padding: 5px;">With Hex Slotted Jackscrews</td> </tr> <tr> <td style="text-align: center; padding: 5px;">485</td> <td style="text-align: center; padding: 5px;">486</td> <td style="padding: 5px;">With Hex Socket Jackscrews</td> </tr> </tbody> </table>	LARGE BORE (22 AWG)	SMALL BORE (24-28 AWG)		475	476	Without Jackscrews	465	466	With Hex Slotted Jackscrews	485	486	With Hex Socket Jackscrews	<div style="border: 1px solid black; padding: 5px; margin-bottom: 10px;"> <p style="background-color: #f4a460; color: white; padding: 2px; margin: 0;">WALL SIZE</p> <table border="1" style="width: 100%; border-collapse: collapse;"> <tr> <td style="background-color: #f4a460; color: white; padding: 2px;">BLANK</td> <td style="padding: 2px;">Wall = 5mm</td> </tr> <tr> <td style="background-color: #f4a460; color: white; padding: 2px;">A</td> <td style="padding: 2px;">Wall = 1mm</td> </tr> </table> </div> <div style="border: 1px solid black; padding: 5px; margin-bottom: 10px;"> <p style="background-color: #f4a460; color: white; padding: 2px; margin: 0;">FINISH</p> <table border="1" style="width: 100%; border-collapse: collapse;"> <tr> <td style="background-color: #f4a460; color: white; padding: 2px;">05</td> <td style="padding: 2px;">Gold</td> </tr> <tr> <td style="background-color: #f4a460; color: white; padding: 2px;">42</td> <td style="padding: 2px;">Gold + Tin</td> </tr> </table> </div> <div style="border: 1px solid black; padding: 5px;"> <p style="background-color: #f4a460; color: white; padding: 2px; margin: 0;">TOTAL NO. OF CONTACTS</p> <p style="padding: 2px;">06, 10, 12, 14, 18, 20, 26, 34, 42, 50</p> </div>	BLANK	Wall = 5mm	A	Wall = 1mm	05	Gold	42	Gold + Tin
LARGE BORE (22 AWG)	SMALL BORE (24-28 AWG)																				
475	476	Without Jackscrews																			
465	466	With Hex Slotted Jackscrews																			
485	486	With Hex Socket Jackscrews																			
BLANK	Wall = 5mm																				
A	Wall = 1mm																				
05	Gold																				
42	Gold + Tin																				

All dimensions in mm.

Datamate J-Tek Connectors

Female Crimp Kit with Hood

- Supplied as a complete kit: jackscrews assembled to housing; hood, contacts and assembly screws supplied loose.
- Provides strain relief by preventing cable bending at the rear of the connector, and also has the option of inserting a cable tie to reduce pull strain.

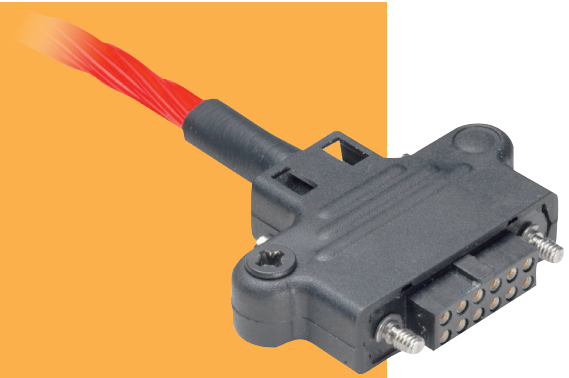

DATAMATE J-TEK

FEMALE		CALCULATION													
	<table border="1"> <tr> <td>A</td> <td>$B + 21.5$</td> </tr> <tr> <td>B</td> <td>Total no. of contacts - 2</td> </tr> <tr> <td>C</td> <td>$B + 7$</td> </tr> </table>		A	$B + 21.5$	B	Total no. of contacts - 2	C	$B + 7$							
	A	$B + 21.5$													
	B	Total no. of contacts - 2													
C	$B + 7$														
TOOLS		WIRE STRIPPING DETAILS													
<p>Recommended Crimp Tool - M22520/2-01 Positioner - T5747 Contact Insertion/Removal Tool - Z80-280</p> <ul style="list-style-type: none"> ➤ Spare and pre-cabled contacts shown on following pages. ➤ Instruction sheets available at www.harwin.com/instructions. 															
HOW TO ORDER															
<p>M80 - 94 X XX XX</p>															
<table border="1"> <thead> <tr> <th colspan="2">SERIES CODE</th> </tr> </thead> <tbody> <tr> <td>0</td> <td>Small Bore (24-28 AWG)</td> </tr> <tr> <td>1</td> <td>Large Bore (22 AWG)</td> </tr> </tbody> </table>		SERIES CODE		0	Small Bore (24-28 AWG)	1	Large Bore (22 AWG)	<table border="1"> <thead> <tr> <th colspan="2">FINISH</th> </tr> </thead> <tbody> <tr> <td>05</td> <td>Gold</td> </tr> <tr> <td>42</td> <td>Gold + Tin</td> </tr> </tbody> </table>		FINISH		05	Gold	42	Gold + Tin
SERIES CODE															
0	Small Bore (24-28 AWG)														
1	Large Bore (22 AWG)														
FINISH															
05	Gold														
42	Gold + Tin														
		<table border="1"> <thead> <tr> <th colspan="2">TOTAL NO. OF CONTACTS</th> </tr> </thead> <tbody> <tr> <td colspan="2">06, 08, 10, 12, 14, 20, 26, 34, 42, 50</td> </tr> </tbody> </table>		TOTAL NO. OF CONTACTS		06, 08, 10, 12, 14, 20, 26, 34, 42, 50									
TOTAL NO. OF CONTACTS															
06, 08, 10, 12, 14, 20, 26, 34, 42, 50															

All dimensions in mm.

Datamate J-Tek Connectors

Spare Female Crimp Contacts

❖ Barrel Crimp Contacts are supplied with the connectors - see previous page. Use the order code for extra spare crimps.



DATAMATE J-TEK

CRIMP CONTACTS	DUMMY CONTACT
<p>Large Bore (22 AWG)</p> <p>Small Bore (24 to 28 AWG)</p> <p>Extra Small Bore (28 to 32 AWG)</p>	<div style="border: 1px solid black; padding: 2px; width: fit-content; margin-top: 5px;"> ORDER CODE M80-023 </div>
	WIRE STRIPPING DETAILS
	TOOLS
	<p>Recommended Crimp Tool - M22520/2-01 Positioner - T5747 Contact Insertion/Removal Tool - Z80-280</p> <ul style="list-style-type: none"> ❖ Pre-cabled contacts shown on following page. ❖ Instruction sheets available at www.harwin.com/instructions.

HOW TO ORDER

M80 - 0XX 00 XX

SERIES CODE

TYPE	
011	Large Bore (22 AWG)
013	Small Bore (24-28 AWG)
019	Extra Small Bore (28-32 AWG)

FINISH

01	Gold + Tin
05	Gold

All dimensions in mm.

Datamate J-Tek Connectors

Female Crimp Contacts – Pre-Crimped Wires

- Female crimp contacts pre-assembled with a choice of BS 3G 210 Type A cable at selected lengths.
- PTFE-insulated, multi-strand silver-plated copper conductor equipment wire.
- Ideal for prototype and pre-production applications.
- For non-standard cable lengths, please visit www.harwin.com/cable-assemblies and fill in your requirements.

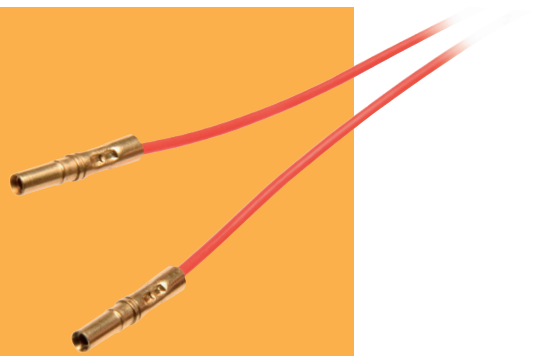

FEMALE SINGLE ENDED	FEMALE - FEMALE

TOOLS

Contact Insertion/Removal Tool – Z80-Z80

- Full crimp connector kits and spare crimp contacts shown on previous pages.
- Instruction sheets available at www.harwin.com/instructions.

HOW TO ORDER

M80 - 9XX 00 99

SERIES CODE

CABLE COLOUR

99	Red
----	-----

SINGLE ENDED	FEMALE-FEMALE	
910	918	22 AWG Cable, 150mm length
911	919	24 AWG Cable, 150mm length
912	920	26 AWG Cable, 150mm length
913	921	28 AWG Cable, 150mm length
914	922	22 AWG Cable, 300mm length
915	923	24 AWG Cable, 300mm length
916	924	26 AWG Cable, 300mm length
917	925	28 AWG Cable, 300mm length

All dimensions in mm.

Datamate J-Tek Connectors

Female Crimp T-Contact

- ❖ Advanced single-piece contact design using Beryllium Copper for a 6-finger contact with improved capabilities.
- ❖ Current carrying capacity up to 8.5 Amps per contact.
- ❖ Improved mating durability to 1,000 operations.
- ❖ Suitable for use with 22AWG cable, Ø1.1mm maximum insulation diameter.
- ❖ Compatible cable housings showing on the following pages - order contact and housings separately.



DATAMATE J-TEK

CRIMP CONTACTS

Large Bore (22 AWG)

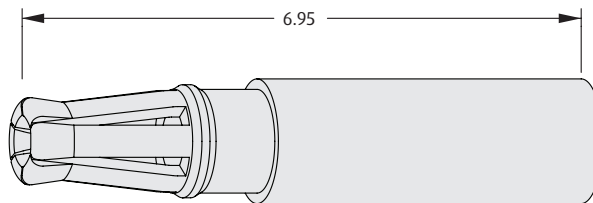

TOOLS

Recommended Crimp Tool - M22520/2-01
Positioner - Z80-444
Contact insertion/Removal Tool - Z80-280
 ❖ Instruction sheets available at www.harwin.com/instructions.

WIRE STRIPPING DETAILS

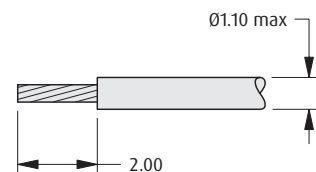

HOW TO ORDER

M80 - 206 00 05

SERIES CODE

FINISH

05 Gold

All dimensions in mm.

Datamate J-Tek Connectors

Female Crimp Housing

- Compatible with all female signal barrel crimp contacts, including T-Contact shown on previous page.
- Use insertion tool to insert crimped contacts into rear of connector housing: **order code Z80-280**.
- Connectors mate with Datamate J-Tek male connectors with applicable jackscrews.
- Jackscrews are supplied already assembled to housing.

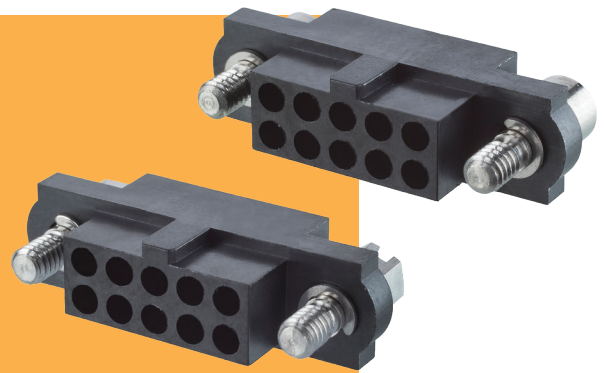

DATAMATE J-TEK

HEX SLOTTED JACKSCREWS

HEX SOCKET JACKSCREWS

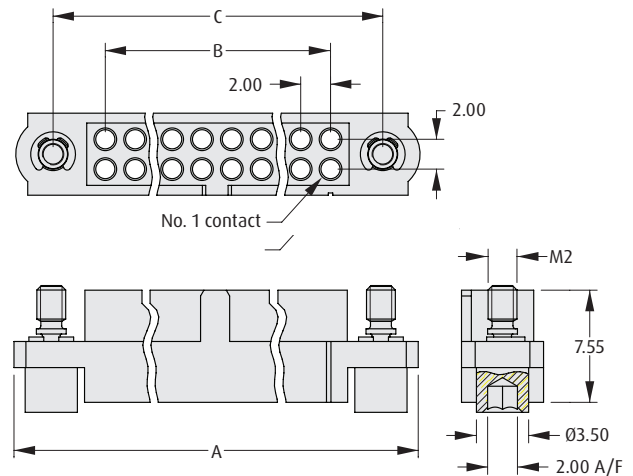
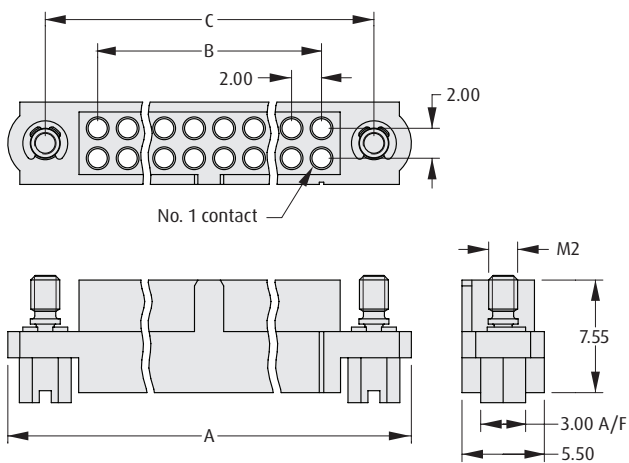

CALCULATION

A	B + 12
B	Total no. of contacts - 2
C	B + 7

HOW TO ORDER

M80 - 41 X XX 98

SERIES CODE

JACKSCREW TYPE

3	Hex Slotted Jackscrews
4	Hex Socket Jackscrews

TOTAL NO. OF CONTACTS

04 to 50

All dimensions in mm.

Datamate J-Tek Connectors

Female Crimp Housing - Guide Pin, 101Lok

- Compatible with all female signal barrel crimp contacts, including T-Contact shown on previous page.
- Guide pin style includes board mount fixing.
- 101Lok fixing gives secure, fast and simple mating; no special tooling required. Just a simple 101-degree turn is required to fix the connectors together.
- Connectors mate with Datamate J-Tek male connectors with applicable jackscrews or 101Lok fixings.

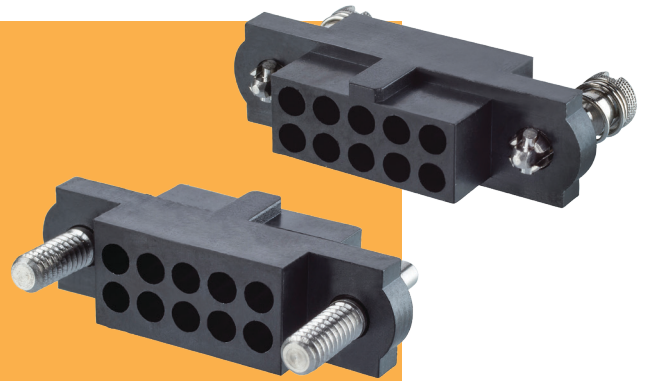

DATAMATE J-TEK

GUIDE PIN JACKSCREWS	101LOK								
<table border="1" style="margin: auto; border-collapse: collapse;"> <thead> <tr style="background-color: #f4a460; color: white;"> <th colspan="2">CALCULATION</th> </tr> </thead> <tbody> <tr> <td style="padding: 2px;">A</td> <td style="padding: 2px;">B + 12</td> </tr> <tr> <td style="padding: 2px;">B</td> <td style="padding: 2px;">Total no. of contacts - 2</td> </tr> <tr> <td style="padding: 2px;">C</td> <td style="padding: 2px;">B + 7</td> </tr> </tbody> </table>		CALCULATION		A	B + 12	B	Total no. of contacts - 2	C	B + 7
CALCULATION									
A	B + 12								
B	Total no. of contacts - 2								
C	B + 7								
HOW TO ORDER									
<p style="font-size: 1.2em; margin: 0;">M80 - 41 X XX 98</p>									
<table border="1" style="width: 100%; border-collapse: collapse;"> <thead> <tr style="background-color: #f4a460; color: white;"> <th colspan="2">SERIES CODE</th> </tr> </thead> <tbody> <tr> <td style="width: 20px; text-align: center;">7</td> <td>Guide Pin Jackscrews</td> </tr> <tr> <td style="width: 20px; text-align: center;">8</td> <td>101Lok</td> </tr> </tbody> </table>	SERIES CODE		7	Guide Pin Jackscrews	8	101Lok	<table border="1" style="width: 100%; border-collapse: collapse;"> <thead> <tr style="background-color: #f4a460; color: white;"> <th>TOTAL NO. OF CONTACTS</th> </tr> </thead> <tbody> <tr> <td style="text-align: center;">04 to 50</td> </tr> </tbody> </table>	TOTAL NO. OF CONTACTS	04 to 50
SERIES CODE									
7	Guide Pin Jackscrews								
8	101Lok								
TOTAL NO. OF CONTACTS									
04 to 50									
HARDWARE FOR GUIDE PIN STUD									
<p>Slotted Board Mount Nut</p> <table border="1" style="margin-top: 10px; border-collapse: collapse;"> <thead> <tr style="background-color: #f4a460; color: white;"> <th>ORDER CODE</th> </tr> </thead> <tbody> <tr> <td style="text-align: center;">M80-2130000B</td> </tr> </tbody> </table>	ORDER CODE	M80-2130000B	<p style="text-align: right;">Order separately from connector</p> <p>Hexagonal Board Mount Nut</p> <table border="1" style="margin-top: 10px; border-collapse: collapse;"> <thead> <tr style="background-color: #f4a460; color: white;"> <th>ORDER CODE</th> </tr> </thead> <tbody> <tr> <td style="text-align: center;">M80-2430000B</td> </tr> </tbody> </table>	ORDER CODE	M80-2430000B				
ORDER CODE									
M80-2130000B									
ORDER CODE									
M80-2430000B									

All dimensions in mm.

Datamate J-Tek Connectors

Female Crimp Housing - Reverse Fix

- Compatible with all female signal barrel crimp contacts, including T-Contact shown on previous page.
- Use insertion tool to insert crimped contacts into rear of connector housing: **order code Z80-280**.
- Jackscrows are supplied already assembled to housing.
- Connectors mate with Datamate J-Tek male connectors with compatible Reverse Fix jackscrows.

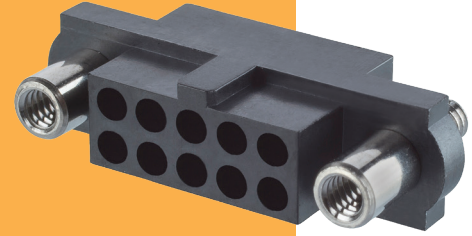

DATAMATE J-TEK

REVERSE FIX JACKSCREWS

CALCULATION

A	B + 12
B	Total no. of contacts - 2
C	B + 7

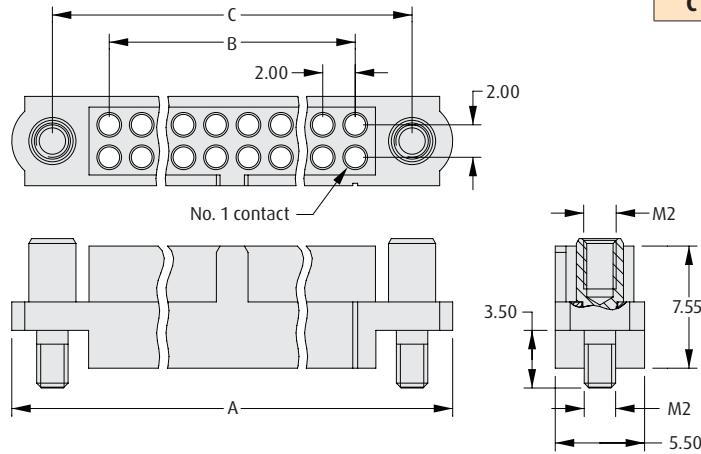

HOW TO ORDER

M80 - 41 5 XX 98

SERIES CODE

JACKSCREW TYPE

5 Reverse Fix Jackscrew

TOTAL NO. OF CONTACTS

04 to 50

HARDWARE FOR PANEL MOUNT STUD

Order separately from connector

Slotted Board Mount Nut

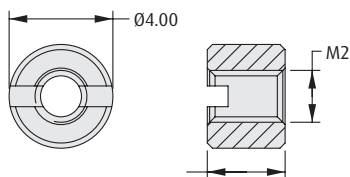

ORDER CODE

M80-2130000B

Hexagonal Board Mount Nut

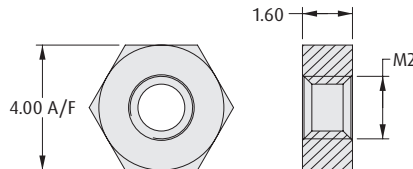

ORDER CODE

M80-2430000B

All dimensions in mm.

Datamate J-Tek Connectors

Female Metal Backshell

- ❖ Supplied as an accessory kit, including metal backshell, e-clips and the applicable jackscrews.
- ❖ To be used with the appropriate size of Female Crimp Kit without jackscrews.
- ❖ Gives 360 degree shielding when used with conductive braid and mated to a compatible male connector with metal backshell.
- ❖ Instruction sheets available at www.harwin.com/instructions.

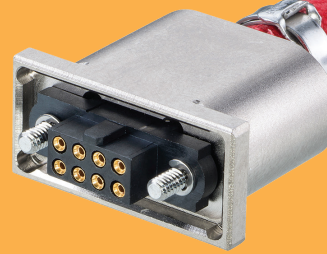

DATAMATE J-TEK

FEMALE		CALCULATION									
		A	$B + 16.2$								
		B	Equivalent no. of contacts - 2								
		C	$B + 7$								
		D	$B + 0.8$								
E-CLIP TOOL		BAND-IT TIE									
❖ For assembling E-Clips supplied with kit.		❖ For fixing braid to rear collar (requires Tie Dex II A30199 Micro Band tool).									
ORDER CODE Z80-300		ORDER CODE M80-9470000									
HOW TO ORDER											
M80 - 94 X XX 02											
SERIES CODE		FINISH									
<table border="1"> <tr> <th>TYPE</th> <th></th> </tr> <tr> <td>5</td> <td>With Slotted Jackscrews</td> </tr> <tr> <td>6</td> <td>With Hex Socket Jackscrews</td> </tr> </table>		TYPE		5	With Slotted Jackscrews	6	With Hex Socket Jackscrews	<table border="1"> <tr> <td>02</td> <td>Nickel</td> </tr> </table>		02	Nickel
TYPE											
5	With Slotted Jackscrews										
6	With Hex Socket Jackscrews										
02	Nickel										
		EQUIVALENT NO. OF SIGNAL CONTACTS 08, 10, 12, 14, 16, 18, 20, 22, 24, 28, 32									

All dimensions in mm.

Datamate J-Tek Connectors

Female Crimp Trio-Tek Housings

- ❖ Part numbers are for housings only, see following page for Trio-Tek contacts.
- ❖ Contacts are rear insertable.
- ❖ Crimp inspection window in housing.
- ❖ Mates with all standard Datamate J-Tek male connectors.
- ❖ Ideal for volume applications.

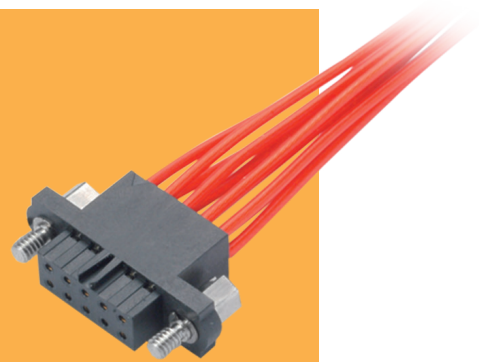

WITHOUT JACKSCREWS		WITH JACKSCREWS											
<table border="1"> <thead> <tr> <th colspan="2">CALCULATION</th> </tr> </thead> <tbody> <tr> <td>A</td> <td>B + 12</td> </tr> <tr> <td>B</td> <td>Total no. of contacts - 2</td> </tr> <tr> <td>C</td> <td>B + 7</td> </tr> </tbody> </table>		CALCULATION		A	B + 12	B	Total no. of contacts - 2	C	B + 7	<div style="display: flex; justify-content: space-around;"> <div style="text-align: center;"> <p>Hex Slotted Jackscrew</p> </div> <div style="text-align: center;"> <p>Hex Socket Jackscrew</p> </div> </div>			
CALCULATION													
A	B + 12												
B	Total no. of contacts - 2												
C	B + 7												
<p>TOOLS</p> <p>Recommended Hand Crimp Tool – Z80-255 Contact Removal Tool – Z80-258</p> <ul style="list-style-type: none"> ❖ Open crimp contacts shown on following page. ❖ Instruction sheets available at www.harwin.com/instructions. 		<p>WIRE STRIPPING DETAILS</p>											
HOW TO ORDER													
M80 - 45X XX 98													
<p>SERIES CODE</p>		<p>FINISH</p> <table border="1"> <tr> <td>98</td> <td>Housings</td> </tr> </table>		98	Housings								
98	Housings												
<table border="1"> <thead> <tr> <th colspan="2">TYPE</th> </tr> </thead> <tbody> <tr> <td>454</td> <td>Without Jackscrews</td> </tr> <tr> <td>455</td> <td>With Hex Slotted Jackscrews</td> </tr> <tr> <td>456</td> <td>With Hex Socket Jackscrews</td> </tr> </tbody> </table>		TYPE		454	Without Jackscrews	455	With Hex Slotted Jackscrews	456	With Hex Socket Jackscrews	<table border="1"> <thead> <tr> <th>TOTAL NO. OF CONTACTS</th> </tr> </thead> <tbody> <tr> <td>04, 06, 08, 10, 12, 14, 20, 26, 34, 42, 50</td> </tr> </tbody> </table>		TOTAL NO. OF CONTACTS	04, 06, 08, 10, 12, 14, 20, 26, 34, 42, 50
TYPE													
454	Without Jackscrews												
455	With Hex Slotted Jackscrews												
456	With Hex Socket Jackscrews												
TOTAL NO. OF CONTACTS													
04, 06, 08, 10, 12, 14, 20, 26, 34, 42, 50													

All dimensions in mm.

Datamate J-Tek Connectors

DATAMATE J-TEK

Female Crimp Trio-Tek - 101Lok

- ❖ Part numbers are for housings only, see following page for Trio-Tek contacts.
- ❖ Ideal for volume applications.
- ❖ 101Lok fixing gives secure, fast and simple mating; no special tooling required. Just a simple 101-degree turn is required to fix the connectors together.
- ❖ Connectors mate with Datamate J-Tek male connectors with 101Lok fixings.



101LOK		CALCULATION	
		A	B + 12
		B	Total no. of contacts - 2
		C	B + 7
TOOLS		WIRE STRIPPING DETAILS	
<p>Recommended Hand Crimp Tool - Z80-255 Contact Removal Tool - Z80-258</p> <ul style="list-style-type: none"> ❖ Open crimp contacts shown on following page. ❖ Instruction sheets available at www.harwin.com/instructions. 			
HOW TO ORDER			
M80 - 459 XX 98			
SERIES CODE			FINISH
TYPE			98 Housings
459 101Lok			TOTAL NO. OF CONTACTS
		04, 06, 08, 10, 12, 14, 20, 26, 34, 42, 50	

All dimensions in mm.

Datamate J-Tek Connectors

Female Crimp Contacts Trio-Tek

- ❖ Trio-Tek contacts must be ordered separately, see previous pages for applicable housings.
- ❖ Crimp contacts are available loose, or in continuous reeled format for automated crimping.

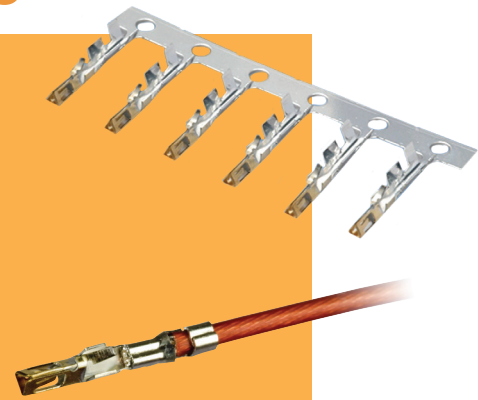

CRIMP CONTACTS	WIRE STRIPPING DETAILS												
<p>Reeled</p> <p>14.18</p>	<p>Ø1.10 max</p> <p>2.70-3.00</p>												
<p>Loose</p> <p>10.18</p>													
HOW TO ORDER													
<p>M80 - XXX 00 XX</p>													
<p>SERIES CODE</p>													
<p>TYPE</p>	<p>FINISH</p>												
<table border="1"> <tbody> <tr> <td style="background-color: #f4a460;">253</td> <td>Trio-Tek Crimp 22-24 AWG, Reeled</td> </tr> <tr> <td style="background-color: #f4a460;">254</td> <td>Trio-Tek Crimp 26-28 AWG, Reeled</td> </tr> <tr> <td style="background-color: #f4a460;">283</td> <td>Trio-Tek Crimp 22-24 AWG, Loose</td> </tr> <tr> <td style="background-color: #f4a460;">284</td> <td>Trio-Tek Crimp 26-28 AWG, Loose</td> </tr> </tbody> </table>	253	Trio-Tek Crimp 22-24 AWG, Reeled	254	Trio-Tek Crimp 26-28 AWG, Reeled	283	Trio-Tek Crimp 22-24 AWG, Loose	284	Trio-Tek Crimp 26-28 AWG, Loose	<table border="1"> <tbody> <tr> <td style="background-color: #f4a460;">42</td> <td>Gold + Tin</td> </tr> <tr> <td style="background-color: #f4a460;">45</td> <td>Gold</td> </tr> </tbody> </table>	42	Gold + Tin	45	Gold
253	Trio-Tek Crimp 22-24 AWG, Reeled												
254	Trio-Tek Crimp 26-28 AWG, Reeled												
283	Trio-Tek Crimp 22-24 AWG, Loose												
284	Trio-Tek Crimp 26-28 AWG, Loose												
42	Gold + Tin												
45	Gold												

All dimensions in mm.

Datamate J-Tek Connectors

DATAMATE J-TEK

Male Vertical PC Tail

- Polarised mouldings.
- Fully shrouded contacts.
- Jackscrews are assembled where specified.
- Choice of PC tail length.
- Board Mount provides PCB strain relief.
- Mates with female Datamate J-Tek connectors with compatible jackscrews.

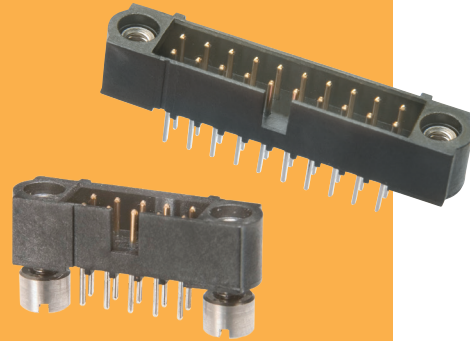

WITHOUT JACKSCREWS		WITH JACKSCREWS		WITH BOARD MOUNT		CALCULATION							
						<table border="1"> <tr> <td>A</td> <td>B + 12</td> </tr> <tr> <td>B</td> <td>Total no. of contacts - 2</td> </tr> <tr> <td>C</td> <td>B + 7</td> </tr> </table>		A	B + 12	B	Total no. of contacts - 2	C	B + 7
A	B + 12												
B	Total no. of contacts - 2												
C	B + 7												
<p>Recommended PC Board Pattern</p>													
HOW TO ORDER													
M80 - 5 X X XX XX													
SERIES CODE						FINISH							
0	With Jackscrews					05	Gold						
1	With Board Mount					42	Gold + Tin						
2	Without Jackscrews												
						TOTAL NO. OF CONTACTS							
0	3mm Tails					04, 06, 08, 10, 12, 14, 20, 26, 34, 42, 50							
1	4.5mm Tails												

All dimensions in mm.

Datamate J-Tek Connectors

Male Vertical PC Tail 101Lok

- ❖ 101Lok fixing gives secure, fast and simple mating; no special tooling required. Just a simple 101-degree turn is required to fix the connectors together.
- ❖ Connectors mate with Datamate J-Tek female connectors with applicable 101Lok fixings.
- ❖ Board Mount provides PCB strain relief.
- ❖ Choice of PC tail length.

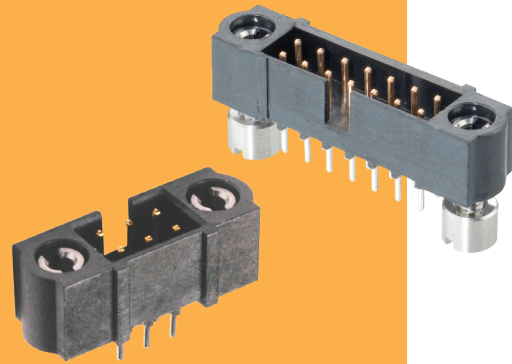

101LOK

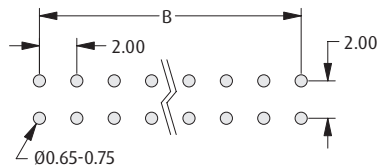
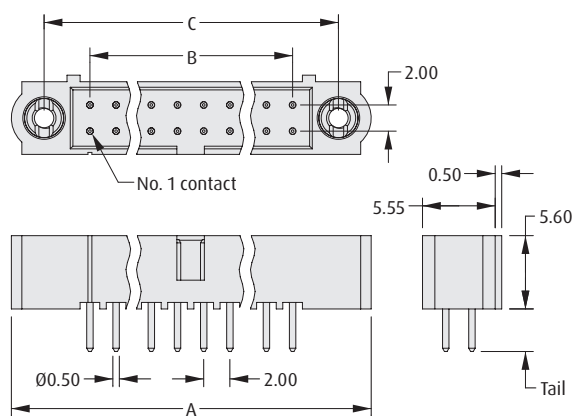

Recommended PC Board Pattern

CALCULATION	
A	$B + 12$
B	Total no. of contacts - 2
C	$B + 7$

101LOK WITH BOARD MOUNT

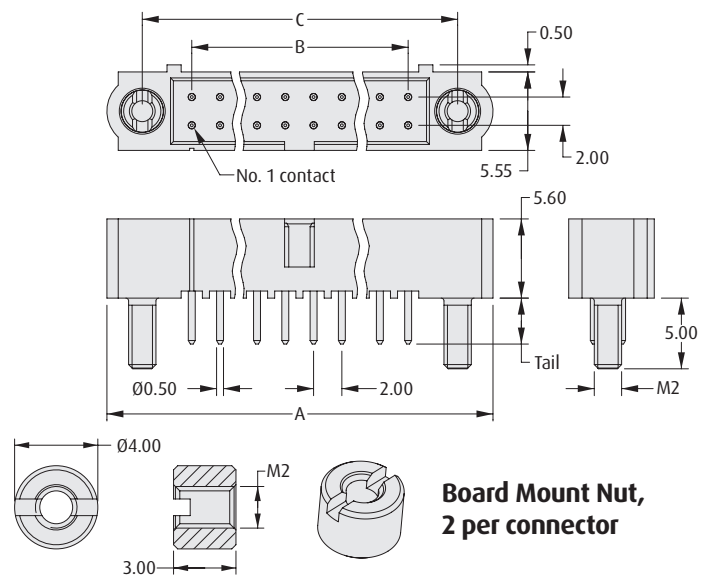

Board Mount Nut, 2 per connector

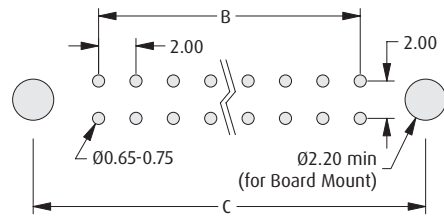

Recommended PC Board Pattern

HOW TO ORDER

M80 - 5 TX XX XX MX

SERIES CODE

TYPE

T1	3mm Tails
T2	4.5mm Tails

TOTAL NO. OF CONTACTS

04, 06, 08, 10, 12, 14, 20, 26, 34, 42, 50

JACKSCREW

MC	101Lok
ME	101Lok with Board Mount

FINISH

05	Gold
42	Gold + Tin

All dimensions in mm.

Datamate J-Tek Connectors

DATAMATE J-TEK

Male Horizontal PC Tail

- Polarised mouldings.
- Fully shrouded contacts.
- Jackscrews are assembled where specified.
- Choice of PC tail length.
- Board Mount provides PCB strain relief.
- Mates with female Datamate J-Tek connectors with compatible jackscrews.

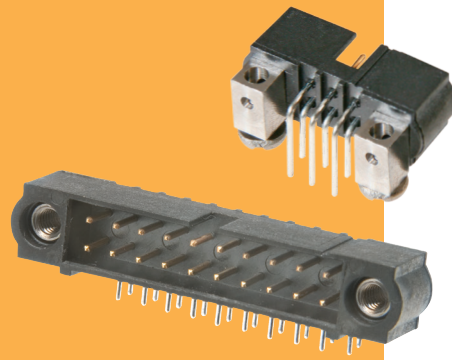

WITHOUT JACKSCREWS

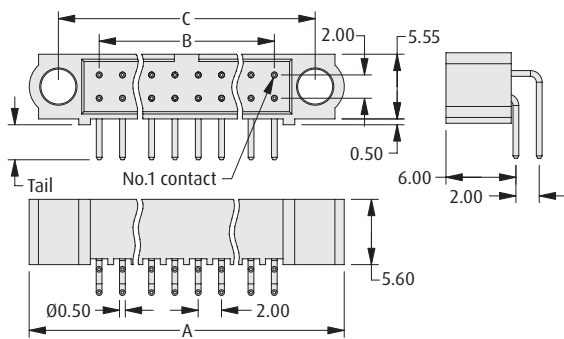

CALCULATION

A	B + 12
B	Total no. of contacts - 2
C	B + 7

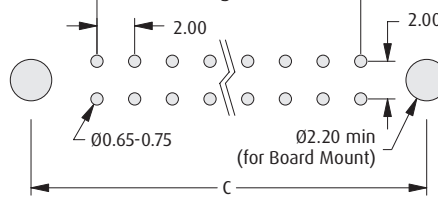

Recommended PC Board Pattern

WITH JACKSCREWS

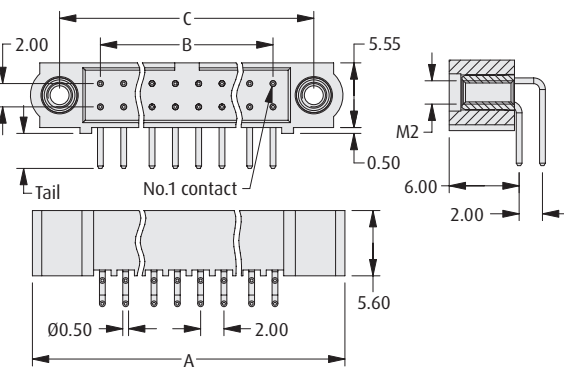

WITH BOARD MOUNT

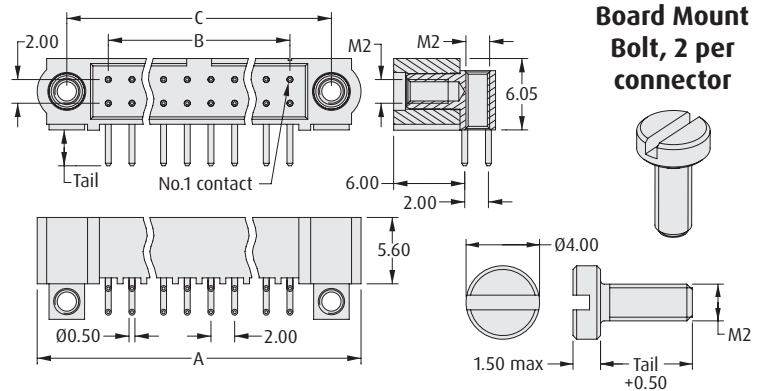

Board Mount Bolt, 2 per connector

HOW TO ORDER

M80 - 5 X X XX XX

SERIES CODE

3	With Jackscrews
4	With Board Mount
5	Without Jackscrews

0	3mm Tails
1	4.5mm Tails

FINISH

05	Gold
42	Gold + Tin

TOTAL NO. OF CONTACTS

04, 06, 08, 10, 12, 14, 20, 26, 34, 42, 50

All dimensions in mm.

Datamate J-Tek Connectors

Male Horizontal PC Tail 101Lok

- ❖ 101Lok fixing gives secure, fast and simple mating; no special tooling required. Just a simple 101-degree turn is required to fix the connectors together.
- ❖ Connectors mate with Datamate J-Tek female connectors with applicable 101Lok fixings.
- ❖ Board Mount provides PCB strain relief.
- ❖ Choice of PC tail length.

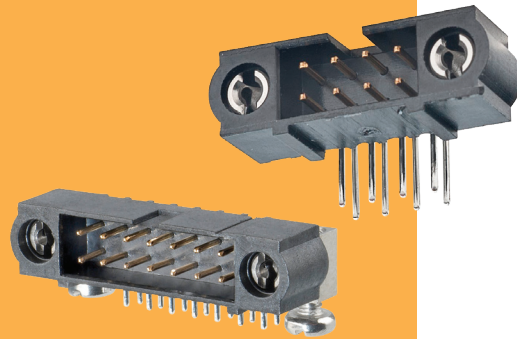

101LOK

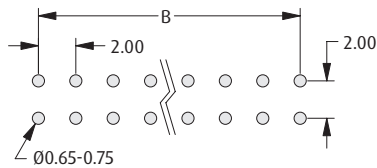
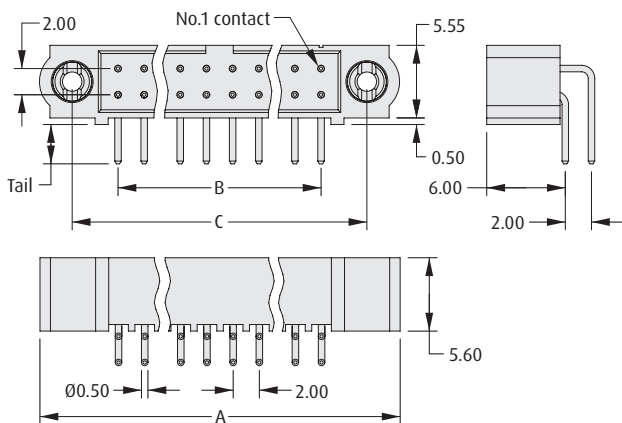

Recommended PC Board Pattern

CALCULATION	
A	$B + 12$
B	Total no. of contacts - 2
C	$B + 7$

101LOK WITH BOARD MOUNT

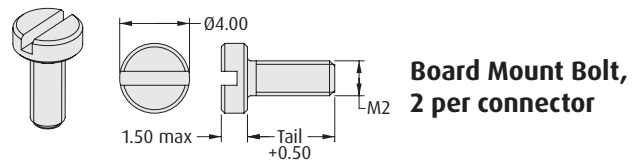
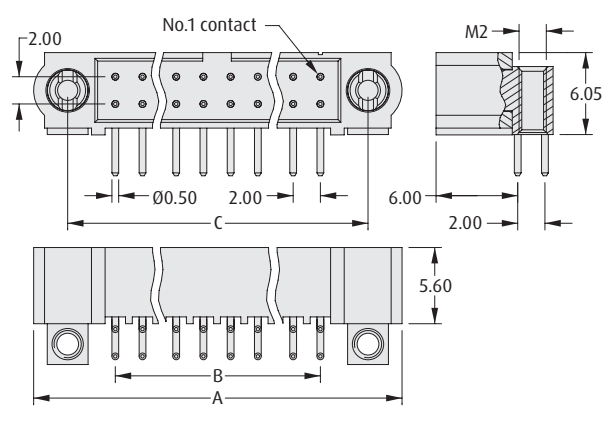

Board Mount Bolt, 2 per connector

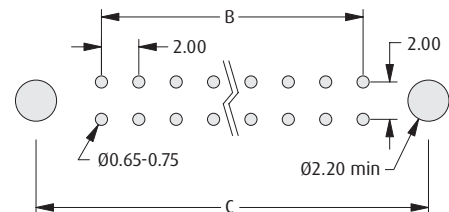

Recommended PC Board Pattern

HOW TO ORDER

M80 - 5 LX XX XX MX

SERIES CODE

TYPE

L1	3mm Tails
L2	4.5mm Tails

TOTAL NO. OF CONTACTS

04, 06, 08, 10, 12, 14, 20, 26, 34, 42, 50

JACKSCREW

MC	101Lok
MD	101Lok with Board Mount

FINISH

05	Gold
42	Gold + Tin

All dimensions in mm.

Datamate J-Tek Connectors

DATAMATE J-TEK

Male Vertical Surface Mount

- Gull wing SMT tails simplify inspection process.
- Board Mount provides PCB strain relief.
- Optional pick and place cap.
- Mates with female Datamate J-Tek connectors with compatible jackscrews.
- Contact datamate@harwin.com for tape and reel options.

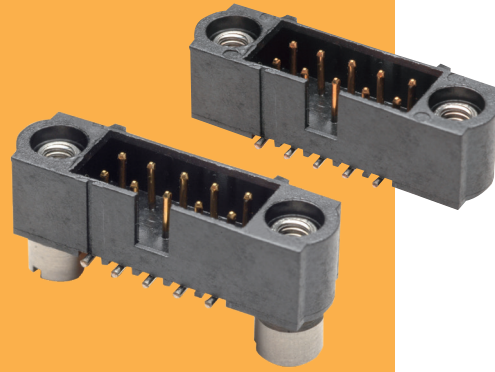

WITHOUT JACKSCREWS		WITH JACKSCREWS		WITH BOARD MOUNT													
				<p>Board Mount Nut, 2 per connector</p> <p>Ø4.00, M2, 3.00</p>													
<p>RECOMMENDED PC BOARD PATTERN</p>		<p>CALCULATION</p> <table border="1"> <tr> <td>A</td> <td>B + 12</td> </tr> <tr> <td>B</td> <td>Total no. of contacts - 2</td> </tr> <tr> <td>C</td> <td>B + 7</td> </tr> </table>		A	B + 12	B	Total no. of contacts - 2	C	B + 7								
A	B + 12																
B	Total no. of contacts - 2																
C	B + 7																
HOW TO ORDER																	
M80 - 5 XX XX XX P																	
<p>SERIES CODE</p>		<p>TOTAL NO. OF CONTACTS</p> <p>04, 06, 08, 10, 12, 14, 20, 26, 34, 42, 50</p>		<p>PICK AND PLACE CAP</p> <table border="1"> <tr> <td>BLANK</td> <td>No Cap</td> </tr> <tr> <td>P</td> <td>Pick & Place Cap</td> </tr> </table>		BLANK	No Cap	P	Pick & Place Cap								
BLANK	No Cap																
P	Pick & Place Cap																
<p>TYPE</p> <table border="1"> <tr> <td>02</td> <td>With Jackscrews</td> </tr> <tr> <td>12</td> <td>With 3.5mm Board Mount</td> </tr> <tr> <td>13</td> <td>With 5mm Board Mount</td> </tr> <tr> <td>22</td> <td>Without Jackscrews</td> </tr> </table>		02	With Jackscrews	12	With 3.5mm Board Mount	13	With 5mm Board Mount	22	Without Jackscrews			<p>FINISH</p> <table border="1"> <tr> <td>05</td> <td>Gold</td> </tr> <tr> <td>42</td> <td>Gold + Tin</td> </tr> </table>		05	Gold	42	Gold + Tin
02	With Jackscrews																
12	With 3.5mm Board Mount																
13	With 5mm Board Mount																
22	Without Jackscrews																
05	Gold																
42	Gold + Tin																

All dimensions in mm.

Datamate J-Tek Connectors

Male Vertical Surface Mount 101Lok

- ❖ 101Lok fixing gives secure, fast and simple mating; no special tooling required. Just a simple 101-degree turn is required to fix the connectors together.
- ❖ Connectors mate with Datamate J-Tek female connectors with applicable 101Lok fixings.
- ❖ Board Mount provides PCB strain relief.
- ❖ Gull wing SMT tails simplify inspection process.
- ❖ Contact datamate@harwin.com for tape and reel options.

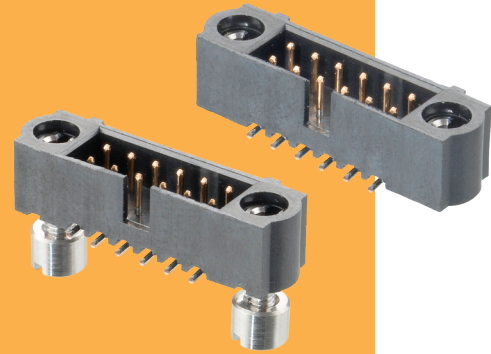

101LOK	101LOK WITH BOARD MOUNT																
 <p>Recommended PC Board Pattern</p>	 <p>Board Mount Nut, 2 per connector</p> <p>Recommended PC Board Pattern</p>																
<table border="1" style="width: 100%;"> <thead> <tr> <th colspan="2" style="background-color: #f4a460;">CALCULATION</th> </tr> </thead> <tbody> <tr> <td style="background-color: #f4a460;">A</td> <td>B + 12</td> </tr> <tr> <td style="background-color: #f4a460;">B</td> <td>Total no. of contacts - 2</td> </tr> <tr> <td style="background-color: #f4a460;">C</td> <td>B + 7</td> </tr> </tbody> </table>		CALCULATION		A	B + 12	B	Total no. of contacts - 2	C	B + 7								
CALCULATION																	
A	B + 12																
B	Total no. of contacts - 2																
C	B + 7																
<h3>HOW TO ORDER</h3> <p style="font-size: 1.2em; font-weight: bold; letter-spacing: 0.5em;">M80 - 5S1 XX XX MX</p>																	
<table border="1" style="width: 100%;"> <thead> <tr> <th style="background-color: #f4a460;">SERIES CODE</th> </tr> </thead> <tbody> <tr> <td style="background-color: #f4a460;">M80</td> </tr> </tbody> </table> <table border="1" style="width: 100%;"> <thead> <tr> <th style="background-color: #f4a460;">TOTAL NO. OF CONTACTS</th> </tr> </thead> <tbody> <tr> <td style="background-color: #f4a460;">04, 06, 08, 10, 12, 14, 20, 26, 34, 42, 50</td> </tr> </tbody> </table>	SERIES CODE	M80	TOTAL NO. OF CONTACTS	04, 06, 08, 10, 12, 14, 20, 26, 34, 42, 50	<table border="1" style="width: 100%;"> <thead> <tr> <th colspan="2" style="background-color: #f4a460;">JACKSCREW</th> </tr> </thead> <tbody> <tr> <td style="background-color: #f4a460;">MC</td> <td>101Lok</td> </tr> <tr> <td style="background-color: #f4a460;">ME</td> <td>101Lok with 5mm Board Mount</td> </tr> </tbody> </table> <table border="1" style="width: 100%;"> <thead> <tr> <th colspan="2" style="background-color: #f4a460;">FINISH</th> </tr> </thead> <tbody> <tr> <td style="background-color: #f4a460;">05</td> <td>Gold</td> </tr> <tr> <td style="background-color: #f4a460;">42</td> <td>Gold + Tin</td> </tr> </tbody> </table>	JACKSCREW		MC	101Lok	ME	101Lok with 5mm Board Mount	FINISH		05	Gold	42	Gold + Tin
SERIES CODE																	
M80																	
TOTAL NO. OF CONTACTS																	
04, 06, 08, 10, 12, 14, 20, 26, 34, 42, 50																	
JACKSCREW																	
MC	101Lok																
ME	101Lok with 5mm Board Mount																
FINISH																	
05	Gold																
42	Gold + Tin																

All dimensions in mm.

Datamate J-Tek Connectors

DATAMATE J-TEK

Male Horizontal Surface Mount

- Stamped contact ensures co-planarity.
- Board Mount provides PCB strain relief.
- Mates with female Datamate J-Tek connectors with compatible jackscrews.
- Contact datamate@harwin.com for tape and reel options.

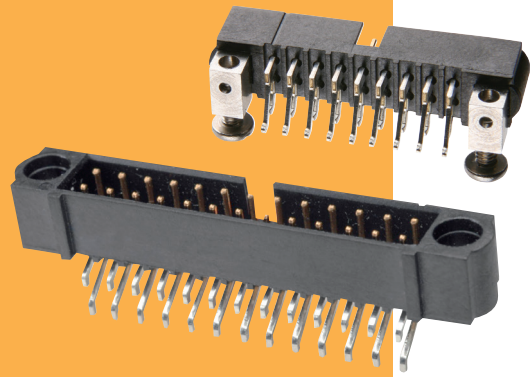

WITHOUT JACKSCREWS		WITH JACKSCREWS		WITH BOARD MOUNT															
				<p>Board Mount Bolt, 2 per connector</p>															
<p>Recommended PC Board Pattern</p>		<p>CALCULATION</p> <table border="1"> <tr> <td>A</td> <td>$B + 12$</td> </tr> <tr> <td>B</td> <td>Total no. of contacts - 2</td> </tr> <tr> <td>C</td> <td>$B + 7$</td> </tr> </table>		A	$B + 12$	B	Total no. of contacts - 2	C	$B + 7$										
A	$B + 12$																		
B	Total no. of contacts - 2																		
C	$B + 7$																		
HOW TO ORDER																			
M80 - 5 XX XX XX																			
<p>SERIES CODE</p> <table border="1"> <tr> <th>TYPE</th> <th></th> </tr> <tr> <td>32</td> <td>With Jackscrews</td> </tr> <tr> <td>42</td> <td>With 3.5mm Board Mount</td> </tr> <tr> <td>43</td> <td>With 5mm Board Mount</td> </tr> <tr> <td>52</td> <td>Without Jackscrews</td> </tr> </table>		TYPE		32	With Jackscrews	42	With 3.5mm Board Mount	43	With 5mm Board Mount	52	Without Jackscrews			<p>FINISH</p> <table border="1"> <tr> <td>05</td> <td>Gold</td> </tr> <tr> <td>42</td> <td>Gold + Tin</td> </tr> </table>		05	Gold	42	Gold + Tin
TYPE																			
32	With Jackscrews																		
42	With 3.5mm Board Mount																		
43	With 5mm Board Mount																		
52	Without Jackscrews																		
05	Gold																		
42	Gold + Tin																		
				<p>TOTAL NO. OF CONTACTS</p> <p>04, 06, 08, 10, 12, 14, 20, 26, 34, 42, 50</p>															

All dimensions in mm.

Datamate J-Tek Connectors

Male Horizontal Surface Mount 101Lok

- ❖ 101Lok fixing gives secure, fast and simple mating; no special tooling required. Just a simple 101-degree turn is required to fix the connectors together.
- ❖ Connectors mate with Datamate J-Tek female connectors with applicable 101Lok fixings.
- ❖ Board Mount provides PCB strain relief.
- ❖ Stamped contact ensures co-planarity.
- ❖ Contact datamate@harwin.com for tape and reel options.

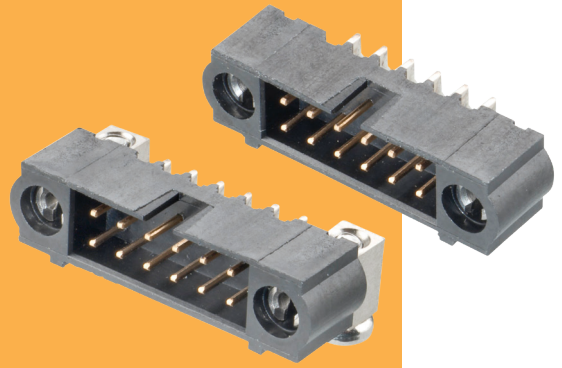

101LOK	101LOK WITH BOARD MOUNT								
<p>Recommended PC Board Pattern</p>	<p>Board Mount Bolt, 2 per connector</p> <p>Recommended PC Board Pattern</p>								
<table border="1" style="width: 100%;"> <thead> <tr> <th colspan="2" style="background-color: #f4a460;">CALCULATION</th> </tr> </thead> <tbody> <tr> <td style="background-color: #f4a460;">A</td> <td>B + 12</td> </tr> <tr> <td style="background-color: #f4a460;">B</td> <td>Total no. of contacts - 2</td> </tr> <tr> <td style="background-color: #f4a460;">C</td> <td>B + 7</td> </tr> </tbody> </table>		CALCULATION		A	B + 12	B	Total no. of contacts - 2	C	B + 7
CALCULATION									
A	B + 12								
B	Total no. of contacts - 2								
C	B + 7								

HOW TO ORDER

M80 - 5S2 XX XX MX

SERIES CODE		JACKSCREW	
TOTAL NO. OF CONTACTS	04, 06, 08, 10, 12, 14, 20, 26, 34, 42, 50	MC	101Lok
		MD	101Lok with Board Mount
		FINISH	
		05	Gold
		42	Gold + Tin

All dimensions in mm.

Datamate J-Tek Connectors

Male Crimp Kit

- Part numbers are for a complete kit of a housing and the applicable number of contacts.
- Jackscrews are assembled where specified.
- Crimp contacts supplied loose.
- Crimp contacts are rear insertable and replaceable.
- Spare contacts are available.

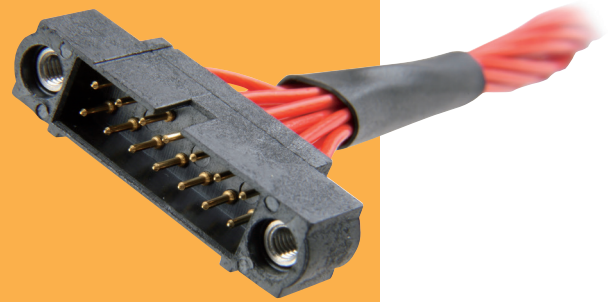

DATAMATE J-TEK

WITHOUT JACKSCREWS	WITH JACKSCREWS																								
<table border="1"> <thead> <tr> <th colspan="2">CALCULATION</th> </tr> </thead> <tbody> <tr> <td>A</td> <td>$B + 12$</td> </tr> <tr> <td>B</td> <td>Total no. of contacts - 2</td> </tr> <tr> <td>C</td> <td>$B + 7$</td> </tr> </tbody> </table>		CALCULATION		A	$B + 12$	B	Total no. of contacts - 2	C	$B + 7$																
CALCULATION																									
A	$B + 12$																								
B	Total no. of contacts - 2																								
C	$B + 7$																								
<p>TOOLS</p> <p>Recommended Crimp Tool - M22520/2-01 Positioner - Z80-193 Contact Insertion/Removal Tool - Z80-280</p> <ul style="list-style-type: none"> Spare contacts shown on following pages. Instruction sheets available at www.harwin.com/instructions. 	<p>WIRE STRIPPING DETAILS</p>																								
<p style="text-align: center;">HOW TO ORDER</p>																									
<p style="text-align: center;">M80 - 5XX XX 05</p> <table border="1" style="width: 100%;"> <thead> <tr> <th colspan="2">SERIES CODE</th> <th colspan="2">FINISH</th> </tr> </thead> <tbody> <tr> <td>TYPE</td> <td></td> <td>05</td> <td>Gold</td> </tr> <tr> <td>570</td> <td>Large Bore (22 AWG), without Jackscrews</td> <td colspan="2"></td> </tr> <tr> <td>571</td> <td>Small Bore (24-28 AWG), without Jackscrews</td> <td colspan="2"></td> </tr> <tr> <td>560</td> <td>Large Bore (22 AWG), with Jackscrews</td> <td colspan="2"></td> </tr> <tr> <td>561</td> <td>Small Bore (24-28 AWG), with Jackscrews</td> <td colspan="2"></td> </tr> </tbody> </table> <p style="text-align: right;">TOTAL NO. OF CONTACTS 04, 06, 08, 10, 12, 14, 20, 26, 34, 42, 50</p>		SERIES CODE		FINISH		TYPE		05	Gold	570	Large Bore (22 AWG), without Jackscrews			571	Small Bore (24-28 AWG), without Jackscrews			560	Large Bore (22 AWG), with Jackscrews			561	Small Bore (24-28 AWG), with Jackscrews		
SERIES CODE		FINISH																							
TYPE		05	Gold																						
570	Large Bore (22 AWG), without Jackscrews																								
571	Small Bore (24-28 AWG), without Jackscrews																								
560	Large Bore (22 AWG), with Jackscrews																								
561	Small Bore (24-28 AWG), with Jackscrews																								

All dimensions in mm.

Datamate J-Tek Connectors

Male Crimp Kit 101Lok

- ❖ Part numbers are for a complete kit of a housing and the applicable number of contacts.
- ❖ 101Lok fixing gives secure, fast and simple mating; no special tooling required. Just a simple 101-degree turn is required to fix the connectors together.
- ❖ Connectors mate with Datamate J-Tek female connectors with applicable 101Lok fixings.
- ❖ Crimp contacts supplied loose.

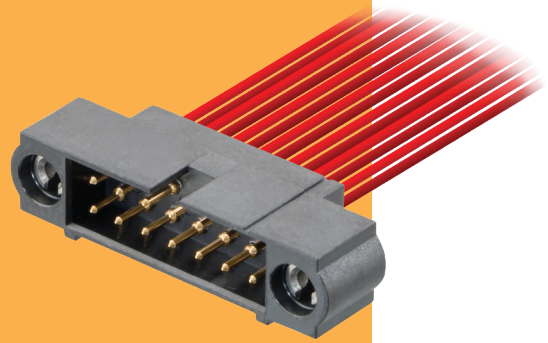

DATAMATE J-TEK

101LOK		CALCULATION	
		A	$B + 12$
		B	Total no. of contacts - 2
		C	$B + 7$
TOOLS		WIRE STRIPPING DETAILS	
<p>Recommended Crimp Tool - M22520/2-01 Positioner - Z80-193 Contact Insertion/Removal Tool - Z80-280</p> <ul style="list-style-type: none"> ❖ Spare contacts shown on following pages. ❖ Instruction sheets available at www.harwin.com/instructions. 			
HOW TO ORDER			
M80 - 5 X1 XX 05 MC			
SERIES CODE			JACKSCREW
TYPE			MC 101Lok
C1 Small Bore (24-28 AWG)			
D1 Large Bore (22 AWG)			
TOTAL NO. OF CONTACTS			FINISH
04, 06, 08, 10, 12, 14, 20, 26, 34, 42, 50			05 Gold

All dimensions in mm.

Datamate J-Tek Connectors

DATAMATE J-TEK

Male Crimp Kit Reverse Fix

- Allows for further flexibility in system design.
- Part numbers are for a complete kit of a housing and the applicable number of contacts.
- Crimp contacts are rear insertable and replaceable.
- Mates with female Datamate J-Tek connectors with compatible Reverse Fix jackscrews.

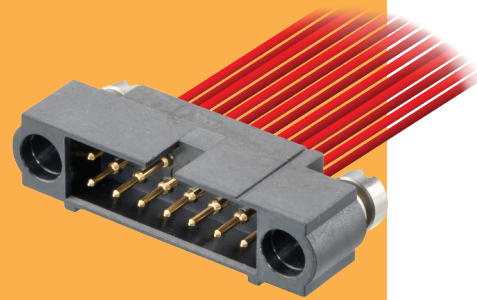

REVERSE FIX		CALCULATION													
		A	$B + 12$												
		B	Total no. of contacts - 2												
		C	$B + 7$												
TOOLS		WIRE STRIPPING DETAILS													
<p>Recommended Crimp Tool - M22520/2-01 Positioner - Z80-193 Contact Insertion/Removal Tool - Z80-280</p> <ul style="list-style-type: none"> Spare contacts shown on following pages. Instruction sheets available at www.harwin.com/instructions. 															
HOW TO ORDER															
M80 - 5XX XX 05															
<p>SERIES CODE</p> <table border="1"> <thead> <tr> <th colspan="2">TYPE</th> </tr> </thead> <tbody> <tr> <td>562</td> <td>Large Bore (22 AWG), Slotted Jackscrew</td> </tr> <tr> <td>563</td> <td>Small Bore (24-28 AWG), Slotted Jackscrew</td> </tr> <tr> <td>582</td> <td>Large Bore (22 AWG), Hex Socket Jackscrew</td> </tr> <tr> <td>583</td> <td>Small Bore (24-28 AWG), Hex Socket Jackscrew</td> </tr> </tbody> </table>		TYPE		562	Large Bore (22 AWG), Slotted Jackscrew	563	Small Bore (24-28 AWG), Slotted Jackscrew	582	Large Bore (22 AWG), Hex Socket Jackscrew	583	Small Bore (24-28 AWG), Hex Socket Jackscrew	<p>FINISH</p> <table border="1"> <tbody> <tr> <td>05</td> <td>Gold</td> </tr> </tbody> </table>		05	Gold
TYPE															
562	Large Bore (22 AWG), Slotted Jackscrew														
563	Small Bore (24-28 AWG), Slotted Jackscrew														
582	Large Bore (22 AWG), Hex Socket Jackscrew														
583	Small Bore (24-28 AWG), Hex Socket Jackscrew														
05	Gold														
		<p>TOTAL NO. OF CONTACTS</p> <p>04, 06, 08, 10, 12, 14, 20, 26, 34, 42, 50</p>													

All dimensions in mm.

Datamate J-Tek Connectors

Male Crimp Kit Extended Wall

- Extended Wall Datamate allows back potting to be performed.
- Fully shrouded contacts.
- Large Bore 22 AWG, Small Bore 24 - 28 AWG.
- Part numbers are for a complete kit of a housing and the applicable number of contacts.
- Crimp contacts are rear insertable and replaceable.
- Crimp contacts supplied loose.

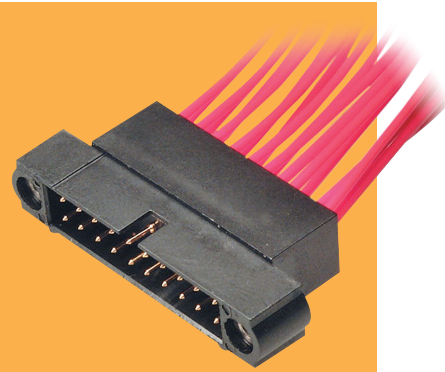

DATAMATE J-TEK

WITHOUT JACKSCREWS	WITH JACKSCREWS																
<div style="border: 1px solid black; padding: 5px; margin-top: 10px;"> <p style="text-align: center; background-color: #f4a460; margin: 0;">CALCULATION</p> <table border="1" style="width: 100%; border-collapse: collapse;"> <tr> <td style="background-color: #f4a460; width: 20px;">A</td> <td>B + 12</td> </tr> <tr> <td style="background-color: #f4a460;">B</td> <td>Total no. of contacts - 2</td> </tr> <tr> <td style="background-color: #f4a460;">C</td> <td>B + 7</td> </tr> </table> </div>	A	B + 12	B	Total no. of contacts - 2	C	B + 7											
A	B + 12																
B	Total no. of contacts - 2																
C	B + 7																
TOOLS	WIRE STRIPPING DETAILS																
<p>Recommended Crimp Tool - M22520/2-01</p> <p>Positioner - Z80-193</p> <p>Contact Insertion/Removal Tool - Z80-280</p> <ul style="list-style-type: none"> Spare contacts shown on following pages. Instruction sheets available at www.harwin.com/instructions. 																	
HOW TO ORDER																	
<p>M80 - 5XX XX 05 X</p>																	
<div style="border: 1px solid black; padding: 5px; margin-bottom: 10px;"> <p style="background-color: #f4a460; margin: 0;">SERIES CODE</p> </div> <table border="1" style="width: 100%; border-collapse: collapse;"> <thead> <tr> <th style="background-color: #f4a460;">TYPE</th> <th></th> </tr> </thead> <tbody> <tr> <td style="background-color: #f4a460;">575</td> <td>Large Bore (22 AWG), without Jackscrews</td> </tr> <tr> <td style="background-color: #f4a460;">576</td> <td>Small Bore (24-28 AWG), without Jackscrews</td> </tr> <tr> <td style="background-color: #f4a460;">565</td> <td>Large Bore (22 AWG), with Jackscrews</td> </tr> <tr> <td style="background-color: #f4a460;">566</td> <td>Small Bore (24-28 AWG), with Jackscrews</td> </tr> </tbody> </table>	TYPE		575	Large Bore (22 AWG), without Jackscrews	576	Small Bore (24-28 AWG), without Jackscrews	565	Large Bore (22 AWG), with Jackscrews	566	Small Bore (24-28 AWG), with Jackscrews	<div style="border: 1px solid black; padding: 5px; margin-bottom: 10px;"> <p style="background-color: #f4a460; margin: 0;">WALL SIZE</p> <table border="1" style="width: 100%; border-collapse: collapse;"> <tr> <td style="background-color: #f4a460;">BLANK</td> <td>Wall = 5mm</td> </tr> <tr> <td style="background-color: #f4a460;">A</td> <td>Wall = 1mm</td> </tr> </table> </div> <div style="border: 1px solid black; padding: 5px; margin-bottom: 10px;"> <p style="background-color: #f4a460; margin: 0;">FINISH</p> <table border="1" style="width: 100%; border-collapse: collapse;"> <tr> <td style="background-color: #f4a460;">05</td> <td>Gold</td> </tr> </table> </div> <div style="border: 1px solid black; padding: 5px;"> <p style="background-color: #f4a460; margin: 0;">TOTAL NO. OF CONTACTS</p> <p style="margin: 0;">06, 10, 14, 20, 26, 34</p> </div>	BLANK	Wall = 5mm	A	Wall = 1mm	05	Gold
TYPE																	
575	Large Bore (22 AWG), without Jackscrews																
576	Small Bore (24-28 AWG), without Jackscrews																
565	Large Bore (22 AWG), with Jackscrews																
566	Small Bore (24-28 AWG), with Jackscrews																
BLANK	Wall = 5mm																
A	Wall = 1mm																
05	Gold																

All dimensions in mm.

Datamate J-Tek Connectors

DATAMATE J-TEK

Male Crimp with Hood

- Supplied as a complete kit: jackscrews assembled to housing; hood, contacts and assembly screws supplied loose.
- Provides strain relief by preventing cable bending at the rear of the connector, and also the option of inserting a cable tie to reduce pull strain.

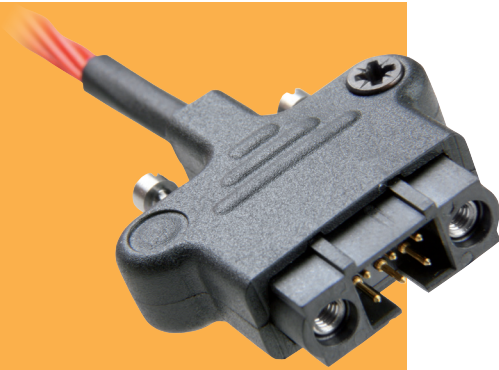

MALE		CALCULATION																			
	<table border="1"> <tr> <td>A</td> <td>$B + 21.5$</td> </tr> <tr> <td>B</td> <td>Total no. of contacts - 2</td> </tr> <tr> <td>C</td> <td>$B + 7$</td> </tr> </table>		A	$B + 21.5$	B	Total no. of contacts - 2	C	$B + 7$													
	A	$B + 21.5$																			
	B	Total no. of contacts - 2																			
C	$B + 7$																				
TOOLS <p> Recommended Crimp Tool - M22520/2-01 Positioner - Z80-193 Contact Insertion/Removal Tool - Z80-280 </p> <ul style="list-style-type: none"> ➤ Spare contacts shown on following pages. ➤ Instruction sheets available at www.harwin.com/instructions. 		WIRE STRIPPING DETAILS																			
HOW TO ORDER																					
M80 - 94 X XX 05																					
<table border="1"> <tr> <th colspan="2">SERIES CODE</th> </tr> <tr> <td> </td> <td> </td> </tr> </table>	SERIES CODE				<table border="1"> <tr> <th colspan="2">TYPE</th> </tr> <tr> <td>2</td> <td>Small Bore (24-28 AWG)</td> </tr> <tr> <td>3</td> <td>Large Bore (22 AWG)</td> </tr> </table>	TYPE		2	Small Bore (24-28 AWG)	3	Large Bore (22 AWG)	<table border="1"> <tr> <th colspan="2">FINISH</th> </tr> <tr> <td>05</td> <td>Gold</td> </tr> </table>	FINISH		05	Gold	<table border="1"> <tr> <th colspan="2">TOTAL NO. OF CONTACTS</th> </tr> <tr> <td colspan="2">06, 08, 10, 12, 14, 20, 26, 34, 42, 50</td> </tr> </table>	TOTAL NO. OF CONTACTS		06, 08, 10, 12, 14, 20, 26, 34, 42, 50	
SERIES CODE																					
TYPE																					
2	Small Bore (24-28 AWG)																				
3	Large Bore (22 AWG)																				
FINISH																					
05	Gold																				
TOTAL NO. OF CONTACTS																					
06, 08, 10, 12, 14, 20, 26, 34, 42, 50																					

All dimensions in mm.

Datamate J-Tek Connectors

Spare Male Crimp Contacts

- Barrel Crimp Contacts are supplied with the connectors - see previous page. Use the order code for extra spare crimps.

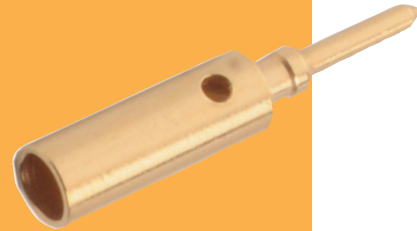

DATAMATE J-TEK

CRIMP CONTACTS	WIRE STRIPPING DETAILS						
<p>Large Bore (22 AWG)</p>							
<p>Small Bore (24 to 28 AWG)</p>							
TOOLS							
<p>Recommended Crimp Tool - M22520/2-01 Positioner - Z80-193 Contact Insertion/Removal Tool - Z80-280</p> <p>❖ Instruction sheets available at www.harwin.com/instructions.</p>							
HOW TO ORDER							
<p>M80 - 19 X 00 05</p>							
<p>SERIES CODE</p>	<p>FINISH</p> <table border="1"> <tr> <td>05</td> <td>Gold</td> </tr> </table>	05	Gold				
05	Gold						
<table border="1"> <thead> <tr> <th colspan="2">TYPE</th> </tr> </thead> <tbody> <tr> <td>4</td> <td>Large Bore (22 AWG)</td> </tr> <tr> <td>5</td> <td>Small Bore (24-28 AWG)</td> </tr> </tbody> </table>	TYPE		4	Large Bore (22 AWG)	5	Small Bore (24-28 AWG)	
TYPE							
4	Large Bore (22 AWG)						
5	Small Bore (24-28 AWG)						

All dimensions in mm.

Datamate J-Tek Connectors

Male Metal Backshell

- ❖ Supplied as an accessory, to be used with existing male connectors.
- ❖ Can be fitted to either male vertical PCB connectors with board mount, or male cable connectors with panel mount jackscrews.
- ❖ Gives 360 degree shielding when mounted to a conductive panel and mated to a compatible female connector with metal backshell.



DATAMATE J-TEK

MALE		CALCULATION	
A	$B + 13.7$	B	Equivalent no. of contacts - 2
C	$B + 7$	C	$B + 7$
D	$B + 2.8$	D	$B + 2.8$

HOW TO ORDER

M80 - 906 XX 02

SERIES CODE	FINISH
M80	02 Nickel

EQUIVALENT NO. OF SIGNAL CONTACTS
08, 10, 12, 14, 16, 18, 20, 22, 24, 28, 32

All dimensions in mm.

Datamate J-Tek 3-Row Specification

Materials

Mouldings:	Glass-filled thermoplastic UL94V-0
Female contacts:	Brass shell, with Beryllium Copper inner contact
Male contacts:	Phosphor bronze
Finish:	Gold

Electrical

Current	
Individual contacts in isolation:	3.3A max (at 25°C) 2.6A max (at 85°C)
All contacts simultaneously:	3.0A max (at 25°C) 2.2A max (at 85°C)
Working voltage	
At sea level 1013 mbar:	800V DC or AC _{rms}
Voltage proof	
At sea level 1013 mbar:	1200V DC or AC _{rms}
Contact resistance	
Initial:	20mΩ max
After conditioning:	25mΩ max
Insulation resistance	
Initial:	1000MΩ min
After conditioning:	100MΩ min

Mechanical

Durability:	500 operations
Insertion force (max):	1.0N
Withdrawal force (min):	0.2N
Signal crimp accommodation:	22 AWG to 28 AWG BS 3G 210 Type A or MIL-DTL-16878/6 Type ET

Environmental

Environmental classification:	55/125/56 days at 95% RH
Operational temperature:	-55°C to +125°C
*Vibration sensitivity:	10Hz to 2000Hz, 0.75mm, 98m/s ² (10G), duration 6h
*Bump severity:	390m/s ² (40G), 4000 ±10 bumps
*Shock severity:	981m/s ² (100G) for 6ms
*Acceleration severity:	490m/s ² (50G)

* Tested with connectors with Jackscrews.

Pin Numbering

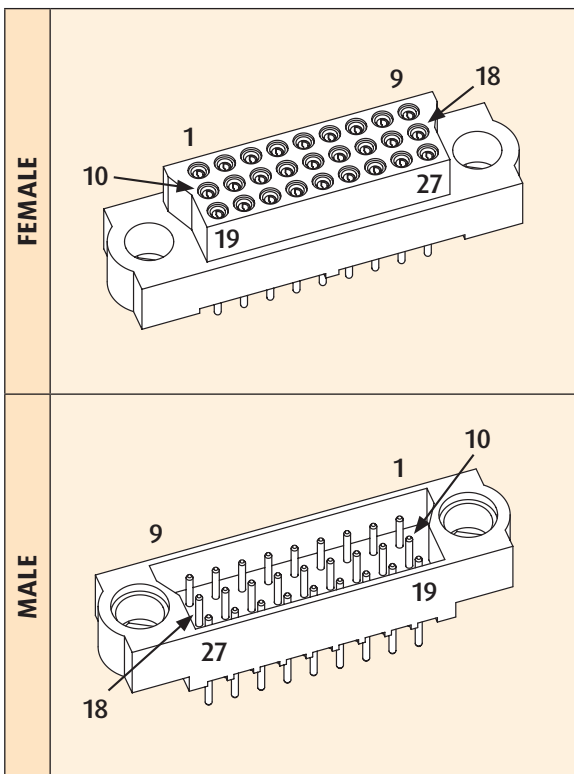

All dimensions in mm.

Mating Profiles

		FEMALE	
		VERTICAL PC TAIL	CRIMP
MALE	VERTICAL PC TAIL		
	HORIZONTAL PC TAIL		

Datamate J-Tek 3-Row Connectors

Female Vertical PC Tail

- ❖ Low-force 4-finger Beryllium Copper contact clip.
- ❖ Fully shrouded contacts.
- ❖ Polarised mouldings.
- ❖ All contacts are gold finish for full RoHS compliance.
- ❖ Mates with all Datamate 3-Row male connectors with compatible jackscrews.

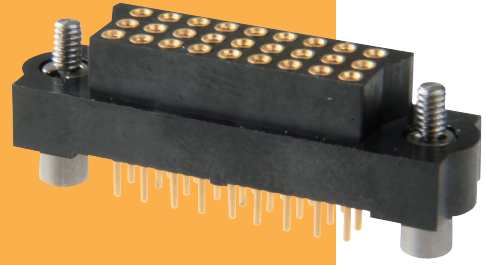

DATAMATE J-TEK 3-ROW

REVERSE FIX

CALCULATION

A	B + 15
B	(Total no. of contacts - 3) x 2/3
C	B + 9

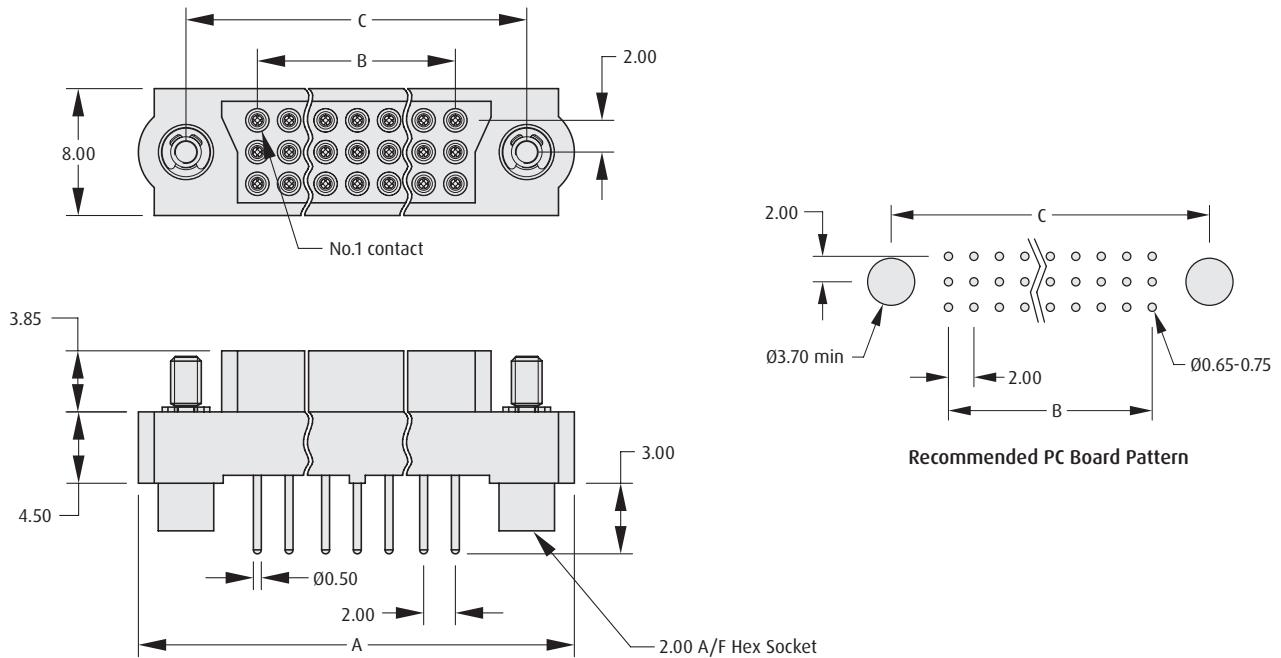

HOW TO ORDER

M83 - LF T1 F2 N XX - 0000 - 000



All dimensions in mm.

Datamate J-Tek 3-Row Connectors

Female Crimp Kit

- Part numbers are for a complete kit of a housing and the applicable number of contacts.
- Jackscrews are assembled where specified.
- Crimp contacts are rear insertable.
- Low-force 4-finger Beryllium Copper contact clip.
- Spare contacts are available.

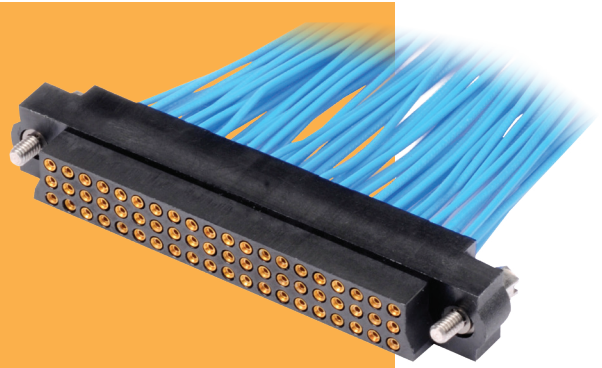

DATAMATE J-TEK 3-ROW

FEMALE CRIMP		CALCULATION									
		A	B + 15								
		B	(Total no. of contacts - 3) x 2/3								
		C	B + 9								
TOOLS		WIRE STRIPPING DETAILS									
<p>Recommended Crimp Tool - M22520/2-01</p> <p>Positioner - T5747</p> <p>Contact Insertion/Removal Tool - Z80-280</p> <ul style="list-style-type: none"> Spare contacts shown on following pages. Instruction sheets available at www.harwin.com/instructions. 											
HOW TO ORDER											
M83 - LF X1 F2 N XX - 0000 - 000											
<p>SERIES CODE</p>		<p>TOTAL NO. OF CONTACTS</p> <p>18, 27, 36, 54, 60, 96</p>									
<table border="1"> <thead> <tr> <th colspan="2">TYPE</th> </tr> </thead> <tbody> <tr> <td>C1</td> <td>Small Bore (24-28 AWG)</td> </tr> <tr> <td>D1</td> <td>Large Bore (22 AWG)</td> </tr> </tbody> </table>		TYPE		C1	Small Bore (24-28 AWG)	D1	Large Bore (22 AWG)	<p>JACKSCREW</p> <table border="1"> <tbody> <tr> <td>F2</td> <td>Hex Socket Jackscrew</td> </tr> </tbody> </table>		F2	Hex Socket Jackscrew
TYPE											
C1	Small Bore (24-28 AWG)										
D1	Large Bore (22 AWG)										
F2	Hex Socket Jackscrew										

All dimensions in mm.

Datamate J-Tek 3-Row Connectors

Spare Female Crimp Contacts

- Barrel Crimp Contacts are supplied with the connectors - see previous page. Use the order code for extra spare crimps.



DATAMATE J-TEK 3-ROW

CRIMP CONTACTS	WIRE STRIPPING DETAILS
<p>Large Bore (22 AWG)</p> <p>7.45</p> <p>2 x Ident Grooves</p> <p>Small Bore (24 to 28 AWG)</p> <p>3 x Ident Grooves</p>	<p>Ø1.10 max</p> <p>2.00</p>
	TOOLS
	<p>Recommended Crimp Tool - M22520/2-01 Positioner - T5747 Contact Insertion/Removal Tool - Z80-280</p> <ul style="list-style-type: none"> Instruction sheets available at www.harwin.com/instructions.

HOW TO ORDER

M83 - 01X 00 05

SERIES CODE

TYPE

011	Large Bore (22 AWG)
013	Small Bore (24-28 AWG)

FINISH

05 Gold

All dimensions in mm.

Datamate J-Tek 3-Row Connectors

Male Vertical PC Tail

- Board Mount nuts to be tightened to a maximum torque of 23cmN.
- Fully shrouded contacts.
- Polarised mouldings.
- All contacts are gold finish for full RoHS compliance.
- Mates with all Datamate 3-Row female connectors with compatible jackscrews.

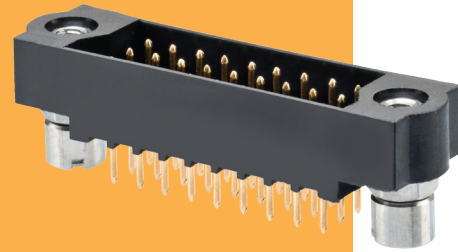

DATAMATE J-TEK 3-ROW

MALE VERTICAL

CALCULATION

A	B + 15
B	(Total no. of contacts - 3) x 2/3
C	B + 9

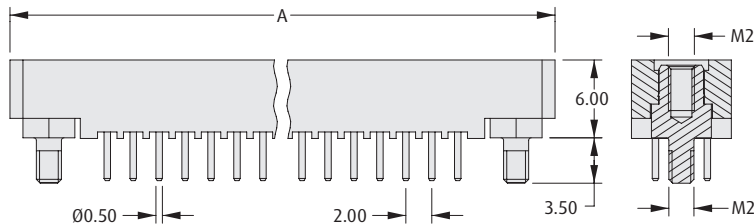
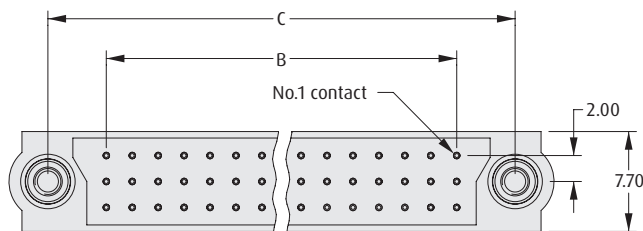

Board Mount Nut, 2 per connector

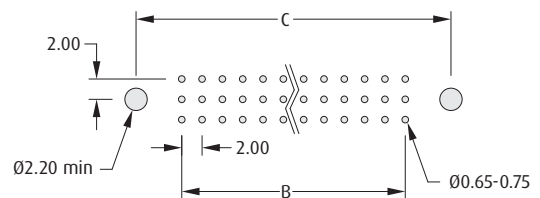
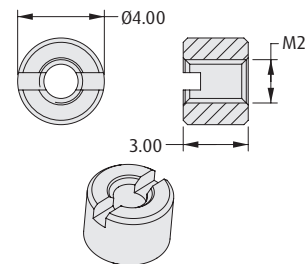

Recommended PC Board Pattern

HOW TO ORDER

M83 - LM T1 M2 N XX - 0000 - 000

SERIES CODE

TYPE

T1 3mm Tail

TOTAL NO. OF CONTACTS

18, 27, 36, 54, 60, 96

JACKSCREW

M2 Board Mount Jackscrew

All dimensions in mm.

Datamate J-Tek 3-Row Connectors

Male Horizontal PC Tail

- Board Mount screws to be tightened to a maximum torque of 23cmN.
- Suitable for motherboard/daughterboard configurations.
- Fully shrouded contacts, polarised mouldings.
- All contacts are gold finish for full RoHS compliance.
- Mates with all Datamate 3-Row female connectors with compatible jackscrews.

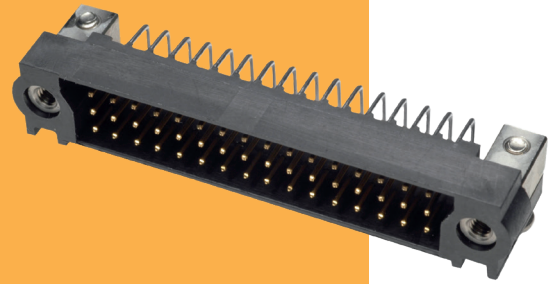

DATAMATE J-TEK 3-ROW

MALE HORIZONTAL

CALCULATION

A	B + 15
B	(Total no. of contacts - 3) x 2/3
C	B + 9

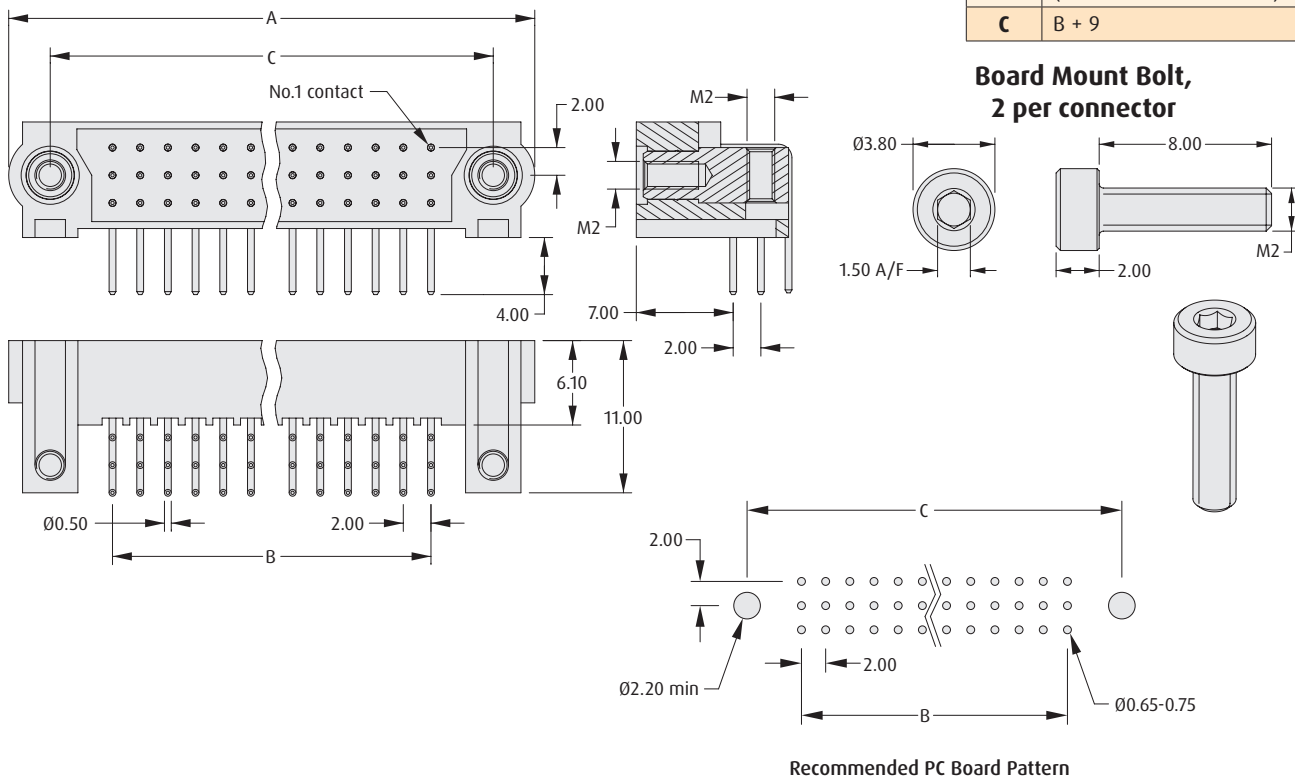

HOW TO ORDER

M83 - LM L3 M7 N XX - 0000 - 000

SERIES CODE

TYPE

L3 4mm Tail

TOTAL NO. OF CONTACTS

18, 27, 36, 54, 60, 96

JACKSCREW

M7 Hex Socket Board Mount

All dimensions in mm.

Datamate L-Tek Specification

Materials

Mouldings:	Glass-filled thermoplastic UL94V-0
Female contacts:	Brass shell, with Beryllium Copper inner contact
Male contacts:	Copper alloy
Finish:	See individual pages

Electrical

Current	
Individual contacts in isolation:	3.3A max (at 25°C) 2.6A max (at 85°C)
All contacts simultaneously:	3.0A max (at 25°C) 2.2A max (at 85°C)
Working voltage	
At sea level 1013 mbar:	800V DC or AC _{rms}
Voltage proof	
At sea level 1013 mbar:	1,200V DC or AC _{rms}
Contact resistance	
Initial:	20mΩ max
After conditioning:	25mΩ max
Insulation resistance	
Initial:	1,000MΩ min
After conditioning:	100MΩ min

Mechanical

Durability	
Standard L-Tek:	500 operations
Trio-Tek:	400 operations
Insertion force (max):	2.8N
Withdrawal force (min):	0.2N
Signal crimp accommodation:	22 AWG to 32 AWG BS 3G 210 Type A, MIL-W-16878

Environmental

Environmental classification:	55/125/56 days at 95% RH
Operational temperature:	-55°C to +125°C
*Vibration sensitivity:	10Hz to 2000Hz, 0.75mm, 98m/s ² (10G), duration 6h
*Bump severity:	390m/s ² (40G), 4000 ±10 bumps
*Shock severity:	981m/s ² (100G) for 6ms
*Acceleration severity:	490m/s ² (50G)





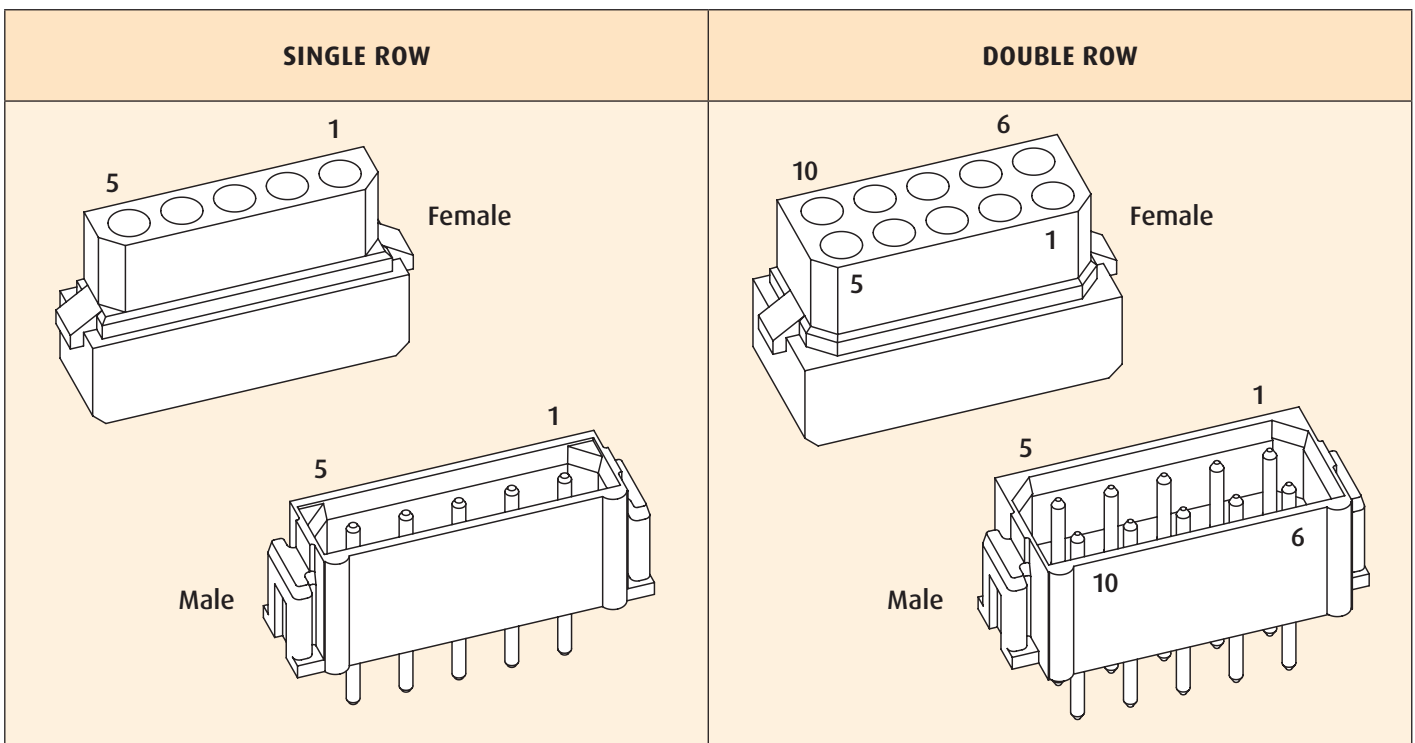

* Tested with latched connectors.

Pin Numbering

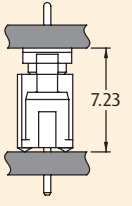
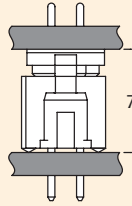
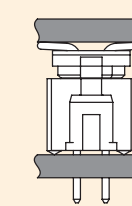
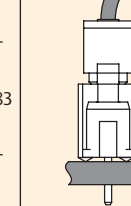
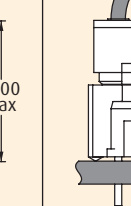
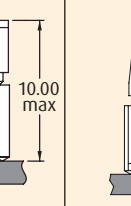
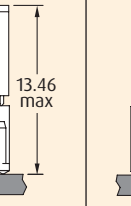
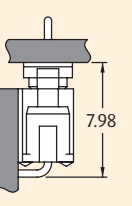
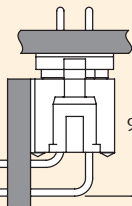
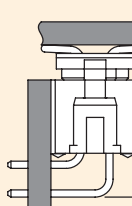
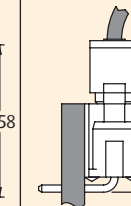
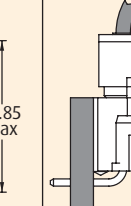
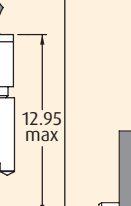
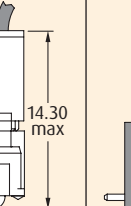
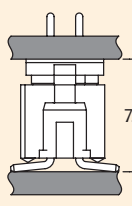
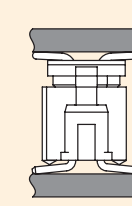
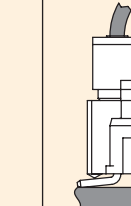

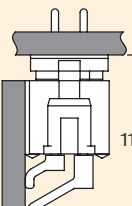
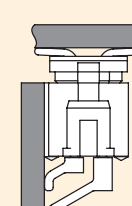
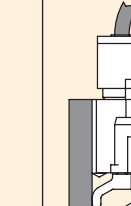
All dimensions in mm.

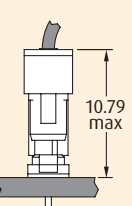
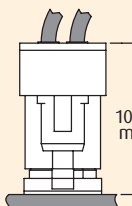
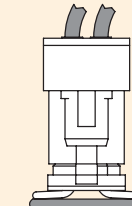
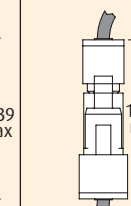
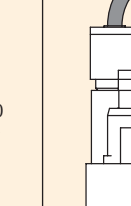
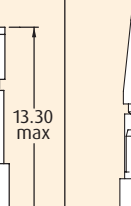
Datamate L-Tek Mating Profiles

		FEMALE						
		VERTICAL PC TAIL		VERTICAL SMT	CRIMP		CRIMP (TRIO-TEK)	
		SIL	DIL	DIL	SIL	DIL	SIL	DIL
MALE	VERTICAL PC TAIL	 7.23	 7.23	 7.83	 10.00 max	 10.00 max	 13.46 max	 13.51 max
	HORIZONTAL PC TAIL	 7.98	 9.98	 10.58	 10.85 max	 12.95 max	 14.30 max	 16.35 max
	VERTICAL SMT		 7.93	 8.53		 10.75 max		 14.25 max
	HORIZONTAL SMT		 11.78	 12.38		 14.60 max		 18.10 max
	CRIMP	 10.79 max	 10.79 max	 11.39 max	 13.30 max	 13.30 max	 16.75 max	 16.80 max

All dimensions in mm.

Datamate L-Tek Connectors

Female Vertical PC Tail

- Polarised mouldings.
- Dummy contacts are available for additional polarisation, use order code M80-023.

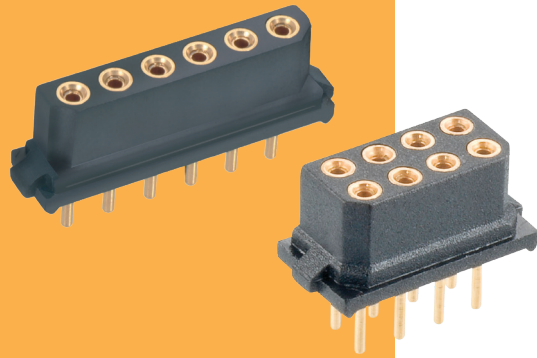

SINGLE ROW

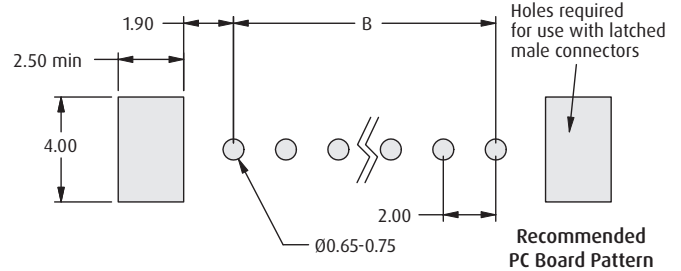
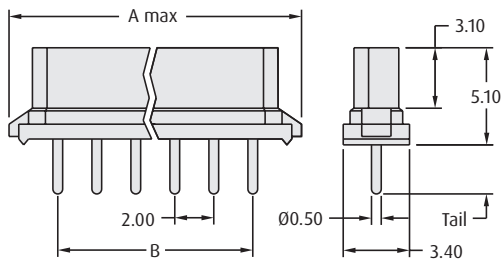

CALCULATION

A	$B + 5.15$
B	$(\text{Total no. of contacts} - 1) \times 2$

DOUBLE ROW

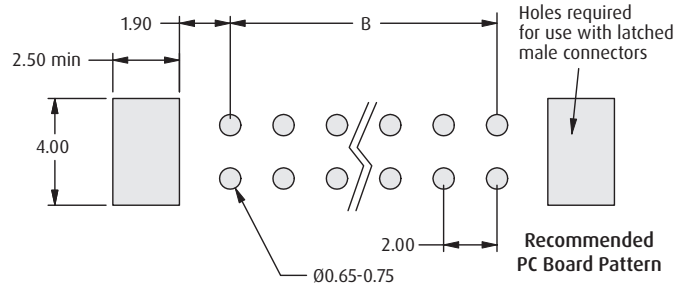
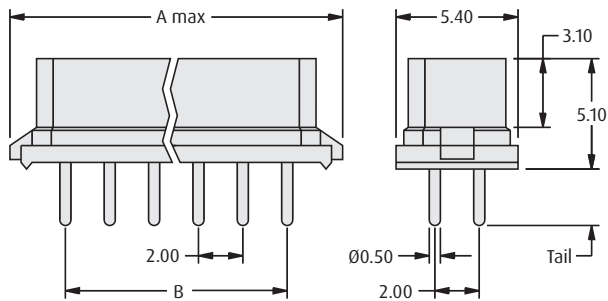

CALCULATION

A	$B + 5.15$
B	$\text{Total no. of contacts} - 2$

HOW TO ORDER

M80 - XXX XX XX

SERIES CODE

TYPE

840	Single Row (3mm tail)
850	Double Row (3mm tail)
790	Single Row (4.5mm tail)
770	Double Row (4.5mm tail)

FINISH

42	Gold + Tin
45	Gold

TOTAL NO. OF CONTACTS

02 to 07, 17, 22	Single Row
04, 06, 08, 10, 12, 14, 16, 18, 20, 26, 34, 44	Double Row

All dimensions in mm.

Datamate L-Tek Connectors

Female Vertical Surface Mount

- ❖ Optional pick and place cap.
- ❖ Contact datamate@harwin.com for tape & reel options.
- ❖ Gull wing SMT tails simplify inspection process.

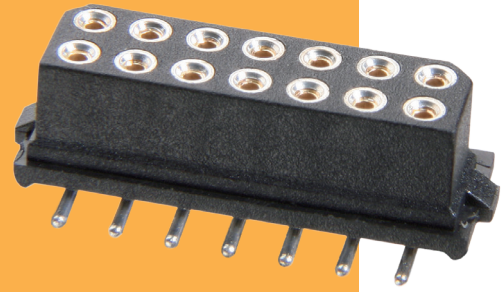

DATAMATE L-TEK

DOUBLE ROW

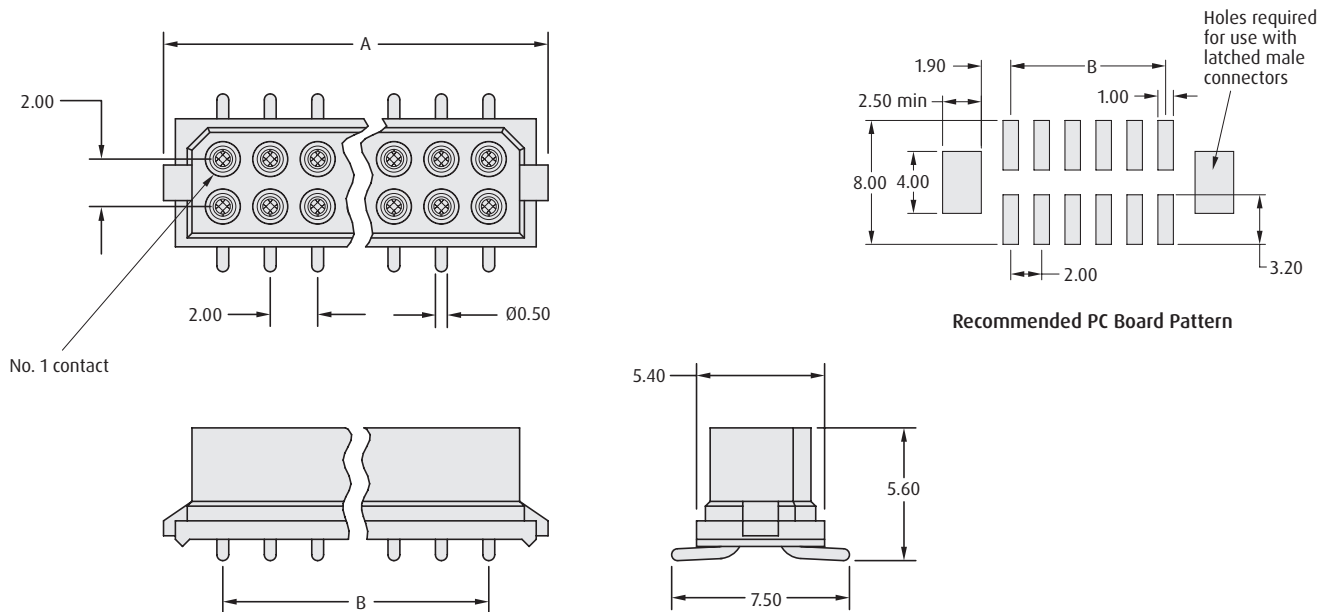

CALCULATION	
A	$B + 5.15$
B	Total no. of contacts - 2

HOW TO ORDER

M80 - 681 XX XX P

SERIES CODE

TOTAL NO. OF CONTACTS
04, 06, 08, 10, 12, 14, 16, 18, 20, 26, 34, 44

PICK AND PLACE CAP	
BLANK	No cap
P	Pick and place cap

FINISH	
42	Gold + Tin
45	Gold

All dimensions in mm.

Datamate L-Tek Connectors

Female Crimp Kit

- Part numbers are for a complete kit of a housing and the applicable number of contacts.
- Contacts are rear insertable.
- Spare contacts are available – see the following page.



SINGLE ROW	CALCULATION	DOUBLE ROW	CALCULATION
	A B + 5.15		A B + 5.15
	B (Total no. of contacts - 1) x 2		B Total no. of contacts - 2
TOOLS	WIRE STRIPPING DETAILS		
<p>Recommended Crimp Tool - M22520/2-01</p> <p>Positioner - T5747</p> <p>Contact Insertion/Removal Tool - Z80-280</p> <ul style="list-style-type: none"> Spare and pre-cabled contacts shown on following pages. Instruction sheets available at www.harwin.com/instructions. 			
HOW TO ORDER			
M80 - XXX XX XX			
SERIES CODE			FINISH
TYPE			TOTAL NO. OF CONTACTS
798 Single Row, Extra Small Bore (28-32 AWG)			02 to 07, 17 Single Row
898 Single Row, Small Bore (24-28 AWG)			04, 06, 08, 10, 12, 14, 16, 18, 20, 26, 34 Double Row
899 Single Row, Large Bore (22 AWG)			
788 Double Row, Extra Small Bore (28-32 AWG)			
888 Double Row, Small Bore (24-28 AWG)			
889 Double Row, Large Bore (22 AWG)			

All dimensions in mm.

Datamate L-Tek Connectors

Spare Female Crimp Contacts

- ❖ Barrel Crimp Contacts are supplied with the connectors - see previous page. Use the order code for extra spare crimps.



DATAMATE L-TEK

CRIMP CONTACTS	WIRE STRIPPING DETAILS												
<p>Large Bore (22 AWG)</p> <p>Small Bore (24 to 28 AWG)</p> <p>Extra Small Bore (28 to 32 AWG)</p>													
	TOOLS												
	<p>Recommended Crimp Tool - M22520/2-01 Positioner - T5747 Contact Insertion/Removal Tool - Z80-280</p> <ul style="list-style-type: none"> ❖ Pre-cabled contacts shown on following page. ❖ Instruction sheets available at www.harwin.com/instructions. 												
HOW TO ORDER													
<p>M80 - 0XX 00 XX</p>													
<p>SERIES CODE</p> <table border="1"> <thead> <tr> <th colspan="2" style="background-color: #f4a460;">TYPE</th> </tr> </thead> <tbody> <tr> <td style="background-color: #f4a460;">011</td> <td>Large Bore (22 AWG)</td> </tr> <tr> <td style="background-color: #f4a460;">013</td> <td>Small Bore (24-28 AWG)</td> </tr> <tr> <td style="background-color: #f4a460;">019</td> <td>Extra Small Bore (28-32 AWG)</td> </tr> </tbody> </table>	TYPE		011	Large Bore (22 AWG)	013	Small Bore (24-28 AWG)	019	Extra Small Bore (28-32 AWG)	<p>FINISH</p> <table border="1"> <tbody> <tr> <td style="background-color: #f4a460;">01</td> <td>Gold + Tin</td> </tr> <tr> <td style="background-color: #f4a460;">05</td> <td>Gold</td> </tr> </tbody> </table>	01	Gold + Tin	05	Gold
TYPE													
011	Large Bore (22 AWG)												
013	Small Bore (24-28 AWG)												
019	Extra Small Bore (28-32 AWG)												
01	Gold + Tin												
05	Gold												

All dimensions in mm.

Datamate L-Tek Connectors

Female Crimp Contacts – Pre-Crimped Wires

- Female crimp contacts pre-assembled with a choice of BS 3G 210 Type A cable at selected lengths.
- PTFE-insulated, multi-strand silver-plated copper conductor equipment wire.
- Ideal for prototype and pre-production applications.
- For non-standard cable lengths, please visit [harwin.com/cable-assemblies](http://www.harwin.com/cable-assemblies) and fill in your requirements.

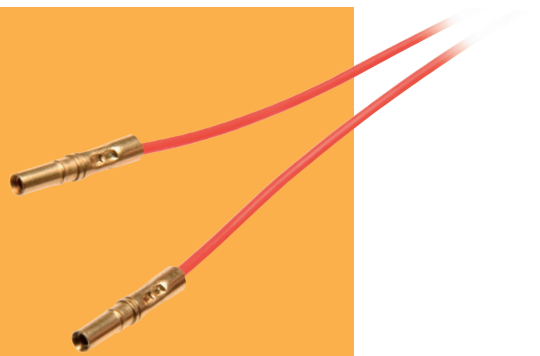

FEMALE SINGLE ENDED	FEMALE - FEMALE

TOOLS

Contact Insertion/Removal Tool – Z80-280

- Full crimp connector kits and spare crimp contacts shown on previous pages.
- Instruction sheets available at www.harwin.com/instructions.

HOW TO ORDER

M80 - 9XX 00 99

SERIES CODE

CABLE COLOUR

99	Red
----	-----

SINGLE ENDED	FEMALE-FEMALE	
910	918	22 AWG Cable, 150mm length
911	919	24 AWG Cable, 150mm length
912	920	26 AWG Cable, 150mm length
913	921	28 AWG Cable, 150mm length
914	922	22 AWG Cable, 300mm length
915	923	24 AWG Cable, 300mm length
916	924	26 AWG Cable, 300mm length
917	925	28 AWG Cable, 300mm length

All dimensions in mm.

Datamate L-Tek Connectors

Female Accessories

- ❖ Crimp Hood is supplied as a kit of parts, including body, lid, cable clamp and 4 screws.
- ❖ For use with double row female crimp connectors.
- ❖ Mates with unlatched male connectors.
- ❖ Dummy contact can be used for additional polarisation or keying of multiple connectors.
- ❖ Fits both female PC Tail and Crimp housings.

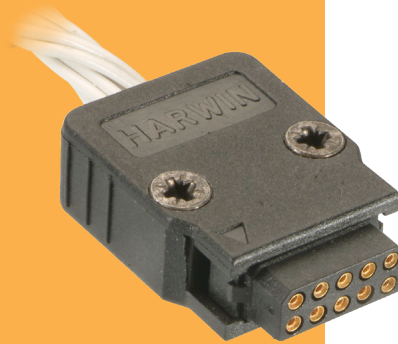

DATAMATE L-TEK

CRIMP HOOD

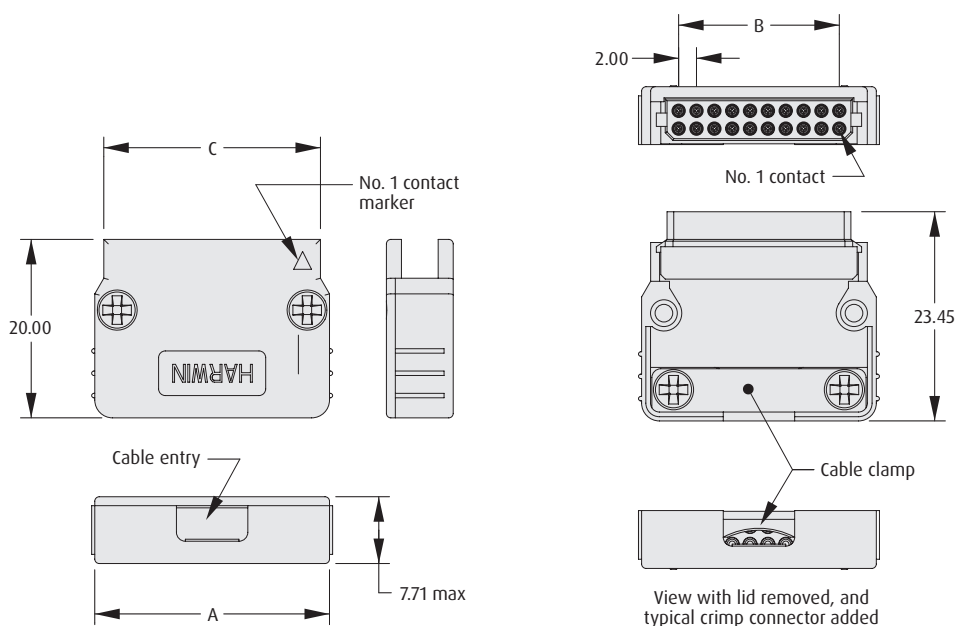

CALCULATION

A	$B + 8.3$
B	Total no. of contacts - 2
C	$B + 6.3$

HOW TO ORDER

M80 - 880 XX 98

SERIES CODE

TOTAL NO. OF CONTACTS

10, 12, 14, 16, 18, 20, 26, 34

DUMMY CONTACT

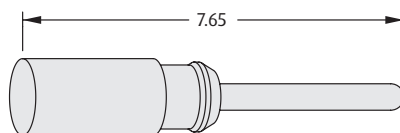

ORDER CODE

M80-023

All dimensions in mm.

Datamate L-Tek Connectors

Female Crimp Housings Trio-Tek

- Part numbers are for housings only, see following page for Trio-Tek contacts.
- Contacts are rear-insertable.
- Crimp inspection window in housing.
- Mates with all standard Datamate L-Tek male connectors.
- Ideal for volume applications.

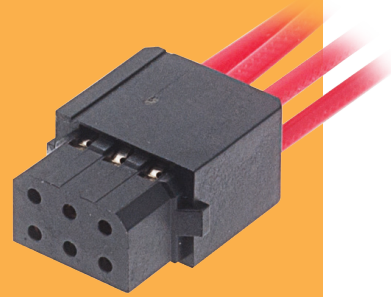

SINGLE ROW	CALCULATION	DOUBLE ROW	CALCULATION								
	<table border="1"> <tr> <td style="background-color: #f4a460;">A</td> <td>B + 5.15</td> </tr> <tr> <td style="background-color: #f4a460;">B</td> <td>(Total no. of contacts - 1) x 2</td> </tr> </table>	A	B + 5.15	B	(Total no. of contacts - 1) x 2		<table border="1"> <tr> <td style="background-color: #f4a460;">A</td> <td>B + 5.15</td> </tr> <tr> <td style="background-color: #f4a460;">B</td> <td>Total no. of contacts - 2</td> </tr> </table>	A	B + 5.15	B	Total no. of contacts - 2
A	B + 5.15										
B	(Total no. of contacts - 1) x 2										
A	B + 5.15										
B	Total no. of contacts - 2										
TOOLS	<p>Recommended Hand Crimp Tool - Z80-255</p> <p>Contact Removal Tool - Z80-258</p> <ul style="list-style-type: none"> Open crimp contacts shown on following page. Instruction sheets available at www.harwin.com/instructions. 		WIRE STRIPPING DETAILS								
HOW TO ORDER											
M80 - 69 X XX 98											
SERIES CODE			FINISH								
			98 Housing								
TYPE			TOTAL NO. OF CONTACTS								
0 Single Row			02 to 07, 17 Single Row								
1 Double Row			04, 06, 08, 10, 12, 14, 16, 18, 20, 26, 34, 44 Double Row								

All dimensions in mm.

Datamate L-Tek Connectors

Female Crimp Contacts Trio-Tek

- ❖ Trio-Tek contacts must be ordered separately, see previous page for applicable housings.
- ❖ Crimp contacts are available loose, or in continuous reeled format for automated crimping.

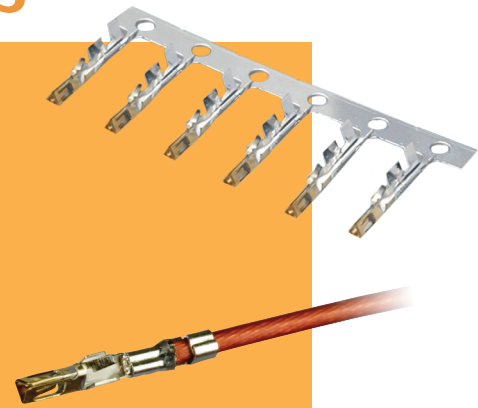

DATAMATE L-TEK

CRIMP CONTACTS	WIRE STRIPPING DETAILS														
<p>Reeled</p> <p>Loose</p>															
	TOOLS														
	<p>Recommended Hand Crimp Tool - Z80-255 Contact Removal Tool - Z80-258</p> <ul style="list-style-type: none"> ❖ Crimp housings shown on previous page. ❖ Instruction sheets available at www.harwin.com/instructions. 														
HOW TO ORDER															
	<p>M80 - 2XX 00 XX</p>														
<p>SERIES CODE</p> <table border="1"> <thead> <tr> <th colspan="2" style="background-color: #f4a460;">TYPE</th> </tr> </thead> <tbody> <tr> <td style="background-color: #f4a460;">253</td> <td>Trio-Tek Crimp 22-24 AWG, Reeled</td> </tr> <tr> <td style="background-color: #f4a460;">254</td> <td>Trio-Tek Crimp 26-28 AWG, Reeled</td> </tr> <tr> <td style="background-color: #f4a460;">283</td> <td>Trio-Tek Crimp 22-24 AWG, Loose</td> </tr> <tr> <td style="background-color: #f4a460;">284</td> <td>Trio-Tek Crimp 26-28 AWG, Loose</td> </tr> </tbody> </table>	TYPE		253	Trio-Tek Crimp 22-24 AWG, Reeled	254	Trio-Tek Crimp 26-28 AWG, Reeled	283	Trio-Tek Crimp 22-24 AWG, Loose	284	Trio-Tek Crimp 26-28 AWG, Loose	<p>FINISH</p> <table border="1"> <tbody> <tr> <td style="background-color: #f4a460;">42</td> <td>Gold + Tin</td> </tr> <tr> <td style="background-color: #f4a460;">45</td> <td>Gold</td> </tr> </tbody> </table>	42	Gold + Tin	45	Gold
TYPE															
253	Trio-Tek Crimp 22-24 AWG, Reeled														
254	Trio-Tek Crimp 26-28 AWG, Reeled														
283	Trio-Tek Crimp 22-24 AWG, Loose														
284	Trio-Tek Crimp 26-28 AWG, Loose														
42	Gold + Tin														
45	Gold														

All dimensions in mm.

Datamate L-Tek Connectors

Male Single Row Vertical PC Tail

- Polarised mouldings.
- Fully shrouded contacts.
- Mates with standard Datamate L-Tek female connectors.
- Can be used with optional Strain Relief straps, available to order separately: **order code M80-0030006**.

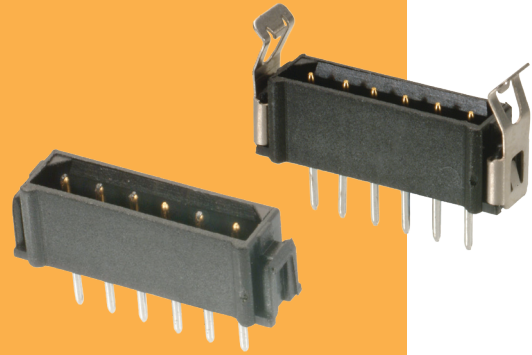

NO LATCHES	CALCULATION	LOCKING LATCH	CALCULATION
	A B + 5.6		A B + 6.1
	B (Total no. of contacts - 1) x 2		B (Total no. of contacts - 1) x 2

STRAIN RELIEF STRAP

Order separately from connector

View of Strain Relief strap in place

ORDER CODE
M80-0030006

Recommended PC Board Pattern

4 x Ø0.90 min (optional) for Strain Relief Straps

HOW TO ORDER

M80 - XXX XX XX

SERIES CODE			FINISH	
3mm TAIL	4.5mm TAIL			
852	752			45 Gold
882	782			
			TOTAL NO. OF CONTACTS	
			02 to 07, 17, 22	

All dimensions in mm.

Datamate L-Tek Connectors

Male Double Row Vertical PC Tail

- ❖ Polarised mouldings.
- ❖ Fully shrouded contacts.
- ❖ Mates with standard Datamate L-Tek female connectors.
- ❖ Can be used with optional Strain Relief straps, available to order separately: **order code M80-0030006**.

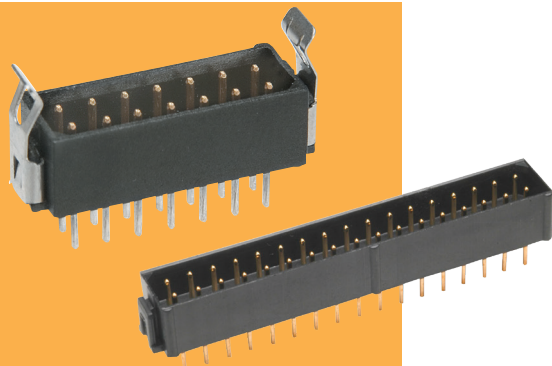

DATAMATE L-TEK

NO LATCHES	CALCULATION	LOCKING LATCH	CALCULATION
	A B + 5.6		A B + 6.1
	B Total no. of contacts - 2		B Total no. of contacts - 2

STRAIN RELIEF STRAP

Order separately from connector

Recommended PC Board Pattern

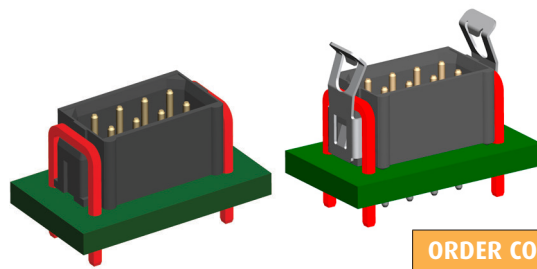
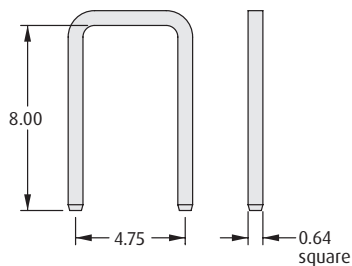

View of Strain Relief strap in place

ORDER CODE
M80-0030006

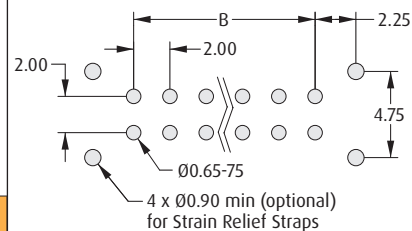

HOW TO ORDER

M80 - XXX XX XX

SERIES CODE

3mm TAIL		4.5mm TAIL	
854	754	No Latches	
853	753	Locking Latch	

FINISH

42	Gold + Tin
45	Gold

TOTAL NO. OF CONTACTS

04, 06, 08, 10, 12, 14, 16, 18, 20, 26, 34, 44

All dimensions in mm.

Datamate L-Tek Connectors

Male Single Row Horizontal PC Tail

- Polarised mouldings.
- Fully shrouded contacts.
- Mates with standard Datamate L-Tek female connectors.
- Supplied with two Strain Relief straps per connector; spares available under **order code M80-0030006**.

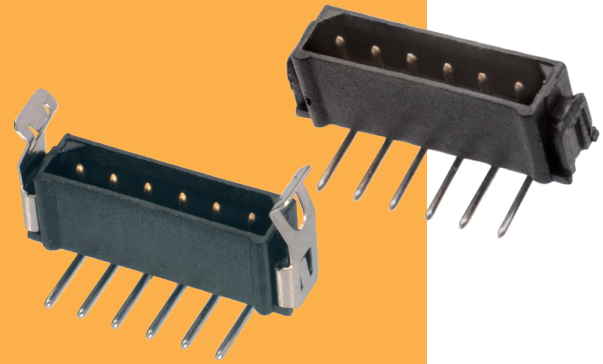

NO LATCHES	CALCULATION	LOCKING LATCH	CALCULATION
	A B + 5.6		A B + 6.1
	B (Total no. of contacts - 1) x 2		B (Total no. of contacts - 1) x 2

STRAIN RELIEF STRAP	Supplied with connector	Recommended PC Board Pattern
	<p>View of Strain Relief strap in place</p>	

HOW TO ORDER

M80 - XXX XX XX

SERIES CODE		FINISH
TYPE		42 Gold + Tin
843 No Latches, 3mm Tail		45 Gold
842 Locking Latch, 3mm Tail		
792 Locking Latch, 4.5mm Tail		
	TOTAL NO. OF CONTACTS	
	02 to 07, 17, 22	

All dimensions in mm.

Datamate L-Tek Connectors

Male Double Row Horizontal PC Tail

- ❖ Polarised mouldings.
- ❖ Fully shrouded contacts.
- ❖ Mates with standard Datamate L-Tek female connectors.
- ❖ Supplied with two Strain Relief straps per connector; spares available under **order code M80-0030006**.

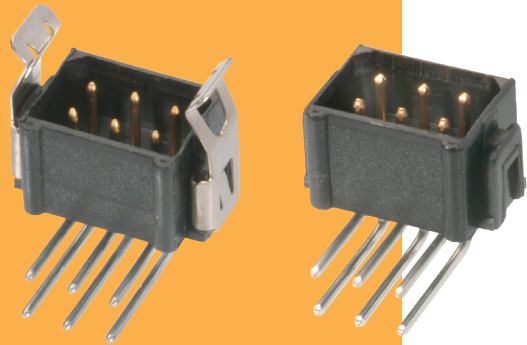

DATAMATE L-TEK

NO LATCHES	CALCULATION	LOCKING LATCH	CALCULATION
	A B + 5.6		A B + 6.1
	B Total no. of contacts - 2		B Total no. of contacts - 2

STRAIN RELIEF STRAP	Supplied with connector	Recommended PC Board Pattern
	<p>View of Strain Relief strap in place</p>	

HOW TO ORDER		
M80 - XXX XX XX		
SERIES CODE		FINISH
TYPE		TOTAL NO. OF CONTACTS
841 No Latches, 3mm Tail		42 Gold + Tin
851 Locking Latch, 3mm Tail		45 Gold
771 Locking Latch, 4.5mm Tail		04, 06, 08, 10, 12, 14, 16, 18, 20, 26, 34, 44

All dimensions in mm.

Datamate L-Tek Connectors

Male Vertical Surface Mount

- Mates with standard Datamate L-Tek female connectors.
- Can be used with optional Strain Relief straps, available to order separately: **order code M80-0030006**.
- Contact datamate@harwin.com for tape & reel options.
- Optional pick and place cap.
- Gull wing SMT tails simplify inspection process.

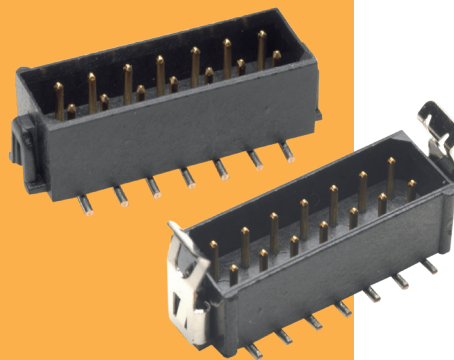

NO LATCHES	CALCULATION	LOCKING LATCH	CALCULATION
	A B + 5.6		A B + 6.1
	B Total no. of contacts - 2		B Total no. of contacts - 2

STRAIN RELIEF STRAP

Order separately from connector

View of Strain Relief strap in place

ORDER CODE

M80-0030006

Recommended PC Board Pattern

4 x Ø0.90 min (optional) for Strain Relief Straps

HOW TO ORDER

SERIES CODE

TYPE	
826	No Latches
828	Locking Latch

M80 - 82X XX XX P

TOTAL NO. OF CONTACTS

04, 06, 08, 10, 12, 14, 16, 18, 20, 26, 34

PICK AND PLACE CAP

BLANK	No cap
P	Pick and place cap

FINISH

42	Gold + Tin
45	Gold

All dimensions in mm.

Datamate L-Tek Connectors

Male Horizontal Surface Mount

- ❖ Mates with standard Datamate L-Tek female connectors.
- ❖ Supplied with two Strain Relief straps per connector; spares available under **order code M80-0030006**.
- ❖ Stamped contact ensures co-planarity.
- ❖ Contact datamate@harwin.com for tape & reel options.

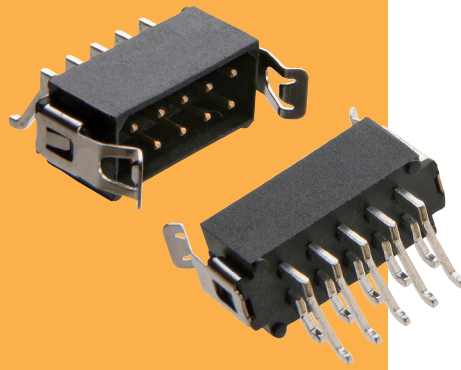

DATAMATE L-TEK

NO LATCHES	CALCULATION	LOCKING LATCH	CALCULATION
	A B + 5.6		A B + 6.1
	B Total no. of contacts - 2		B Total no. of contacts - 2

STRAIN RELIEF STRAP	Supplied with connector	Recommended PC Board Pattern
	<p style="text-align: center;">View of Strain Relief strap in place</p>	

HOW TO ORDER						
SERIES CODE	M80 - 66X XX 42	FINISH				
TYPE		42 Gold + Tin				
<table border="1"> <tr> <td>665</td> <td>No Latches</td> </tr> <tr> <td>666</td> <td>Locking Latch</td> </tr> </table>	665	No Latches	666	Locking Latch		TOTAL NO. OF CONTACTS
665	No Latches					
666	Locking Latch					
		04, 06, 08, 10, 12, 14, 16, 18, 20, 26, 34, 44				

All dimensions in mm.

Datamate L-Tek Connectors

Male Crimp Kit

- Part numbers are for a complete kit of a housing and the applicable number of contacts.
- Contacts are rear insertable.
- Spare contacts are available - see the following page.
- Back potting & cable assembly service available, contact cables@harwin.com.

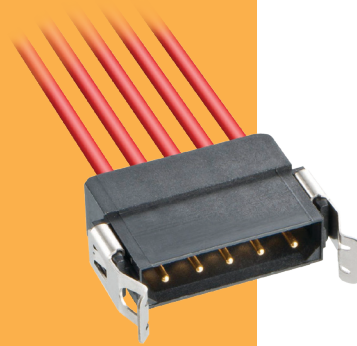

DATAMATE L-TEK

SINGLE ROW	CALCULATION	DOUBLE ROW	CALCULATION
	A B + 5.6		A B + 5.6
Latches (when fitted) add 0.5mm to overall length 'A'	B (Total no. of contacts - 1) x 2	Latches (when fitted) add 0.5mm to overall length 'A'	B Total no. of contacts - 2

TOOLS	WIRE STRIPPING DETAILS
<p>Recommended Crimp Tool - M22520/2-01</p> <p>Positioner - T5747</p> <p>Contact Insertion/Removal Tool - Z80-280</p> <ul style="list-style-type: none"> Spare contacts shown on following page. Instruction sheets available at www.harwin.com/instructions. 	

HOW TO ORDER

M80 - 8XX XX 05

SERIES CODE

SINGLE ROW	DOUBLE ROW	
806	810	Small Bore (24-28 AWG), No Latches
807	811	Large Bore (22 AWG), No Latches
808	812	Small Bore (24-28 AWG), Locking Latch
809	813	Large Bore (22 AWG), Locking Latch

FINISH

05 Gold

TOTAL NO. OF CONTACTS

02, 03, 04, 05, 06, 07	Single Row
04, 06, 08, 10, 12	Double Row

All dimensions in mm.

Datamate L-Tek Connectors

Spare Male Crimp Contacts

- ❖ Barrel Crimp Contacts are supplied with the connectors - see previous page. Use the order code for extra Spare crimps.

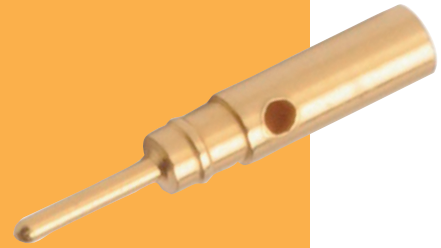

CRIMP CONTACTS	WIRE STRIPPING DETAILS						
<p>Large Bore (22 AWG)</p> <p>8.63</p>	<p>Ø1.10 max</p> <p>2.00</p>						
<p>Small Bore (24 to 28 AWG)</p> <p>Ident Groove</p>							
	<p>TOOLS</p> <p>Recommended Crimp Tool - M22520/2-01 Positioner - T5747 Contact Insertion/Removal Tool - Z80-280</p> <p>❖ Instruction sheets available at www.harwin.com/instructions.</p>						
<p>HOW TO ORDER</p>							
<p>M80 - 04X 00 05</p>							
<p>SERIES CODE</p>	<p>FINISH</p> <table border="1"> <tr> <td>05</td> <td>Gold</td> </tr> </table>	05	Gold				
05	Gold						
<table border="1"> <thead> <tr> <th colspan="2">TYPE</th> </tr> </thead> <tbody> <tr> <td>040</td> <td>Large Bore (22 AWG)</td> </tr> <tr> <td>041</td> <td>Small Bore (24-28 AWG)</td> </tr> </tbody> </table>	TYPE		040	Large Bore (22 AWG)	041	Small Bore (24-28 AWG)	
TYPE							
040	Large Bore (22 AWG)						
041	Small Bore (24-28 AWG)						

All dimensions in mm.

Datamate Tooling

- ❖ Instruction sheets can be accessed at www.harwin.com/instructions.
- ❖ A Datamate Crimping Instruction video is available at www.harwin.com/harwintv.

HAND CRIMP TOOL	HAND CRIMP TOOL														
<ul style="list-style-type: none"> ❖ Standard circular crimp tool BS5210-3A-300 and MIL specification M22520/2-01. ❖ Precision tool with ratchet mechanism and 8-indent form. ❖ Must be used with applicable positioner shown below. ❖ Instruction sheet available.  <table border="1" data-bbox="430 1003 808 1108"> <thead> <tr> <th colspan="2">ORDER CODE</th> </tr> </thead> <tbody> <tr> <td>Signal contacts, L-Tek, J-Tek & Mix-Tek</td> <td>M22520/2-01</td> </tr> </tbody> </table>	ORDER CODE		Signal contacts, L-Tek, J-Tek & Mix-Tek	M22520/2-01	<ul style="list-style-type: none"> ❖ Standard circular crimp tool. ❖ Precision tool with ratchet mechanism and 8-indent form. ❖ Must be used with applicable positioner shown below. ❖ Instruction sheet available.  <table border="1" data-bbox="1166 1003 1511 1108"> <thead> <tr> <th colspan="2">ORDER CODE</th> </tr> </thead> <tbody> <tr> <td>Inner contact of Mix-Tek coax contacts</td> <td>Z80-292</td> </tr> </tbody> </table>	ORDER CODE		Inner contact of Mix-Tek coax contacts	Z80-292						
ORDER CODE															
Signal contacts, L-Tek, J-Tek & Mix-Tek	M22520/2-01														
ORDER CODE															
Inner contact of Mix-Tek coax contacts	Z80-292														
HAND CRIMP TOOL	POSITIONER														
<ul style="list-style-type: none"> ❖ Standard coax crimp tool for crimping the outer sleeve of Mix-Tek coax contacts. ❖ Instruction sheet available.  <table border="1" data-bbox="467 1795 808 1900"> <thead> <tr> <th colspan="2">ORDER CODE</th> </tr> </thead> <tbody> <tr> <td>Outer sleeve of Mix-Tek coax contacts</td> <td>Z80-293</td> </tr> </tbody> </table>	ORDER CODE		Outer sleeve of Mix-Tek coax contacts	Z80-293	<ul style="list-style-type: none"> ❖ Used with applicable hand crimp tool.  <table border="1" data-bbox="1071 1659 1511 1900"> <thead> <tr> <th colspan="2">ORDER CODE</th> </tr> </thead> <tbody> <tr> <td>Female Signal Barrel Crimp, Male L-Tek Crimp</td> <td>T5747</td> </tr> <tr> <td>Male J-Tek, Mix-Tek Signal Crimp</td> <td>Z80-193</td> </tr> <tr> <td>Inner contact of Mix-Tek coax contacts</td> <td>Z80-291</td> </tr> <tr> <td>Female T-Contact</td> <td>Z80-444</td> </tr> </tbody> </table>	ORDER CODE		Female Signal Barrel Crimp, Male L-Tek Crimp	T5747	Male J-Tek, Mix-Tek Signal Crimp	Z80-193	Inner contact of Mix-Tek coax contacts	Z80-291	Female T-Contact	Z80-444
ORDER CODE															
Outer sleeve of Mix-Tek coax contacts	Z80-293														
ORDER CODE															
Female Signal Barrel Crimp, Male L-Tek Crimp	T5747														
Male J-Tek, Mix-Tek Signal Crimp	Z80-193														
Inner contact of Mix-Tek coax contacts	Z80-291														
Female T-Contact	Z80-444														

Datamate Tooling

- ❖ Instruction sheets can be accessed at www.harwin.com/instructions.
- ❖ A Datamate Crimping Instruction video is available at www.harwin.com/harwintv.

INSERTION/REMOVAL TOOL	REMOVAL TOOL								
<ul style="list-style-type: none"> ❖ For inserting crimped contacts into the rear of mouldings. ❖ Instruction sheet available. ❖ Suitable for all Datamate signal Barrel crimp contacts.  <table border="1" style="margin-left: auto; margin-right: auto;"> <thead> <tr> <th colspan="2" style="background-color: #f4a460;">ORDER CODE</th> </tr> </thead> <tbody> <tr> <td>Barrel Signal crimps for L-Tek, J-Tek & Mix-Tek</td> <td style="text-align: center;">Z80-280</td> </tr> </tbody> </table>	ORDER CODE		Barrel Signal crimps for L-Tek, J-Tek & Mix-Tek	Z80-280	<ul style="list-style-type: none"> ❖ To aid removal of special cable contacts from Mix-Tek connectors.  <table border="1" style="margin-left: auto; margin-right: auto;"> <thead> <tr> <th colspan="2" style="background-color: #f4a460;">ORDER CODE</th> </tr> </thead> <tbody> <tr> <td>Mix-Tek special cable connectors</td> <td style="text-align: center;">Z80-290</td> </tr> </tbody> </table>	ORDER CODE		Mix-Tek special cable connectors	Z80-290
ORDER CODE									
Barrel Signal crimps for L-Tek, J-Tek & Mix-Tek	Z80-280								
ORDER CODE									
Mix-Tek special cable connectors	Z80-290								
SEPARATOR TOOL	SCREWDRIVER								
<ul style="list-style-type: none"> ❖ Recommended for unplugging L-Tek latched connectors (tool releases the latches prior to disengagement). ❖ Can also be used with unlatched and friction latched connectors. ❖ Suitable for all sizes.  <table border="1" style="margin-left: auto; margin-right: auto;"> <thead> <tr> <th colspan="2" style="background-color: #f4a460;">ORDER CODE</th> </tr> </thead> <tbody> <tr> <td>L-Tek</td> <td style="text-align: center;">Z80-299</td> </tr> </tbody> </table>	ORDER CODE		L-Tek	Z80-299	<ul style="list-style-type: none"> ❖ Recommended for use on J-Tek board mount nuts. ❖ Board mount nuts and bolts to be tightened to a torque of 21 ±2cmN.  <table border="1" style="margin-left: auto; margin-right: auto;"> <thead> <tr> <th colspan="2" style="background-color: #f4a460;">ORDER CODE</th> </tr> </thead> <tbody> <tr> <td>J-Tek screwdriver</td> <td style="text-align: center;">Z80-298</td> </tr> </tbody> </table>	ORDER CODE		J-Tek screwdriver	Z80-298
ORDER CODE									
L-Tek	Z80-299								
ORDER CODE									
J-Tek screwdriver	Z80-298								

Datamate Tooling

❖ Technical drawings can be accessed from the individual product pages at www.harwin.com - just search for the part number.

<p>HEX DRIVE BIT</p> <ul style="list-style-type: none"> ❖ 1.5mm A/F Hex end for board mount Hex Socket bolts. ❖ For use with torque tooling or similar equipment.  <p>ORDER CODE Z9950-00</p>	<p>HEX DRIVE BIT</p> <ul style="list-style-type: none"> ❖ 2mm A/F Hex end for Hex Socket floating jackscrews (Female jackscrews or Male Reverse fix jackscrews). ❖ For use with torque tooling or similar equipment.  <p>ORDER CODE Z9951-00</p>
<p>BALL HEX DRIVER</p> <ul style="list-style-type: none"> ❖ 1.5mm A/F Hex end for board mount Hex Socket bolts. ❖ Ball-shaped end can be used at a wide range of angles.  <p>ORDER CODE Z9952-00</p>	<p>BALL HEX DRIVER</p> <ul style="list-style-type: none"> ❖ 2mm A/F Hex end for Hex Socket floating jackscrews (Female jackscrews or Male Reverse fix jackscrews). ❖ Ball-shaped end can be used at a wide range of angles.  <p>ORDER CODE Z9953-00</p>

Datamate Tooling

- ❖ Tooling suitable for Datamate Trio-Tek contacts and housings.
- ❖ Instruction sheets can be accessed at www.harwin.com/instructions.

<p>HAND CRIMP TOOL</p> <ul style="list-style-type: none">❖ 'Rigidus' crimp tool design.❖ Precision parallel action crimp tool with ratchet mechanism.❖ Supplied with locator and die-set - spares available.❖ Instruction sheet available.  <p>ORDER CODE Z80-255</p>	<p>REMOVAL TOOL</p> <ul style="list-style-type: none">❖ For removal of crimped contacts from mouldings.❖ Instruction sheet available.  <p>ORDER CODE Z80-258</p>
<p>SPARE DIE-SET</p> <ul style="list-style-type: none">❖ Spare die-set for use with hand crimp tool shown above.  <p>ORDER CODE Z80-244</p>	<p>SPARE LOCATOR</p> <ul style="list-style-type: none">❖ Used with hand crimp tool shown above.  <p>ORDER CODE Z80-259</p>