

PLASTIC R SERIES CONNECTORS

R SERIES



LEMO

Table of Contents

General Production Program	page 2
Main Characteristics and Types	2
Series and Types	3
LEMO's Push-Pull Self-Latching Connection System	4
R Series Production Program	4
Series and Contact configuration	4
R Series Section	5
Interconnections	6
Model Description	6
Part Number Example	7
Part Selection Showing Internal Components	7
Housing Models	8-9
Alignment Key and Polarized Keying System	10
Crimp Contacts	11
Mixed Hybrid Overview	12
Inserts Multipole	13
Mixed High Voltage + Low Voltage	14-15
Mixed Coax & Low Voltage	16-17
Mixed Fluidic & Low Voltage	18
Fluidic/Pneumatic Contacts	19-20
Housing Colors	21
Accessories	22-23
Insulators for crimp contacts	22
Clamping and Bracketing	22
Inserts and Crimp contacts	23
Tooling	24-25
Crimping tools	24
Positioners for crimp contact	24
Extractor for crimp contact	25
Panel Cut-Outs	26
Mounting	26
PCB Drilling Pattern	26
Fixed receptacle with straight print contacts	26
Technical Characteristics	27
Outer Shell	27
Insulator	27
Electrical contact	28
Crimp contacts	29

General Production Program

Connectors

- Unipole from 2 to 150 Amps
- Coaxial 50 and 75 Ω
- Coaxial 50 Ω (NIM-CAMAC)
- Coaxial 50 Ω for frequency → 12 GHz
- Multicoaxial 50 and 75 Ω
- Multipole from 2 to 66 contacts
- Multipole up to 106 contacts
- High Voltage 3, 5, 8, 10, 15, 30 and 50 kV cc
- Multi High Voltage 3, 5, and 10 kV cc
- Triaxial 50 and 75 Ω
- Quadrax
- Mixed: High Voltage (HV) + Low Voltage (LV)
- Mixed: Coax + LV
- Mixed: Triax + LV
- Thermocouple
- Multithermocouple
- Fiber optic singlemode
- Fiber optic multimode
- Mixed: fiber optic + LV
- Mixed: fiber optic + coax + LV
- Fluidic
- Multifluidic
- Mixed: fluidic + LV
- Subminiature
- Miniature
- Plastic
- Printed circuit board
- Remote handling
- Watertight
- Sealed (pressure and/or vacuum)
- With plastic outer shell
- With aluminum outer shell
- With stainless steel outer shell
- With special radiation resistant insulator material
- With screw thread coupling for very high pressure
- With microswitch

Patch Panels

- For audio-mono applications: triax
- For audio-mono applications: 3 contacts
- For audio-stereo applications: quadrax
- For audio-stereo applications: 6 contacts
- For video applications: coax 75 Ω
- For video HDTV applications: 3 coax 75 Ω + 2LV

Patch Panels For fiber optic applications

Adapters For BNC, C, UHF, N, CINCH, GEN-RADIO connectors
For TNC, SMA connectors

Accessories

- Insulator for crimp contacts
- Crimp contacts
- Coaxial contacts
- Triaxial contacts
- Fiber optic contacts
- Fiber optic ferrules
- Caps
- Bend relief
- Heatshrink boot
- Insulating washers
- Double plastic panel washers
- Locking washers
- Tapered washers
- Hexagonal nuts
- Conical nuts
- Round nuts
- Notched nuts
- Earthing washers
- Lead-through with cable collet

Tooling





- Wrenches
- Assembly tool
- Pliers
- Taps
- Crimping tools
- Positioners
- Crimping dies
- Extractors
- Banding tool
- Retention testing tool for crimp contacts
- Fiber optic termination workstation
- Fiber optic polishing tools

On request

- Filtered connectors
- Connectors with special housing
- Mixed special configuration
- Assembly onto cable

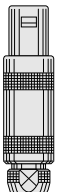
● Connectors, accessories and tools found in this catalog.

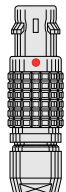
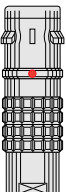
Main Characteristics and Types

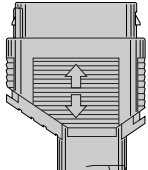
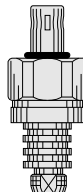
							
Series	STANDARD	WATERTIGHT	KEYED	KEYED WATERTIGHT	HARSH ENVIRONMENTS	RECTANGULAR	SCREW
	01 (Minax)	0E to 6E	00 (multipole)	0K to 5K	FF to 5F	RR / OR / 1R	03
	00 (NIM-CAMAC)	3T	0B to 5B	2N to 5N			0V to 5V
	00 (unipole)	4M	2G / 5G				0W to 5W
	05 / R0						2U to 5U
	0S to 6S						0M-1M-2M
	0A / 4A						
	1D / 2C						
	1Y-3Y-6Y						
Latching	Push-Pull						Screw
Key	Stepped insert (Half-Moon)		Key (G) or other key-way code		Key (N) or other key-way code	Key G or A	Key (G) or stepped insert (Half-Moon)
Shell	Metal or plastic	Metal	Metal or plastic	Metal		Plastic	Metal
Insert	Hermaphroditic or cylindrical		Cylindrical			Rectangular	Hermaphroditic or cylindrical
Contact	Solder or print		Solder, crimp or print		Crimp or print	Crimp or print	Solder (crimp or print)

Series and Types

	Series	Types																				
		Unipole	Coaxial 50 Ω	Coaxial 75 Ω	Multipole	High Voltage	Triaxial 50 Ω	Triaxial 75 Ω	Quadrax	Multi HV	Multi Coaxial	Mixed HV+LV	Mixed Coax+LV	Mixed Triax+LV	Fiber Optic	Multi FO	Mixed FO+LV	Fluidic	Multi fluidic	Mixed fluidic+LV	Thermocouple	
Standard	01		●																			
	00	●	●				●											●				
	05					●																
	R0		●																			
	0A		●	●																		
	0S	●	●		●	●	●															●
	1S	●	●	●	●	●	●															●
	2S	●	●	●	●	●	●	●														●
	3S	●	●	●	●	●	●	●		●			●									
	4S	●	●	●	●	●	●	●		●	●		●	●								
	5S	●	●	●	●					●	●	●	●	●								
	6S				●						●		●									
	1D								●													
	2C		●		●																	
4A							●															
1Y-3Y-6Y					●																	
Watertight	0E	●	●		●	●	●															●
	1E	●	●	●	●	●	●															●
	2E	●	●	●	●	●	●					●										●
	3E	●	●	●	●	●	●		●			●	●									
	4E	●	●	●	●		●	●				●	●									
	5E	●			●					●	●	●	●									
	6E				●						●		●									
	3T			●				●														
4M						●	●															
Keyed	00				●										●							●
	0B				●										●			●				●
	1B				●							●										●
	2B				●					●	●	●	●	●			●	●				●
	3B				●					●	●	●	●	●		●	●		●	●		●
	4B				●					●	●	●	●	●		●	●		●	●		●
	5B				●					●	●	●	●	●		●	●		●	●		●
2G				●																		
5G								●														
Keyed watertight	0K				●										●			●				●
	1K				●							●										●
	2K				●						●	●	●	●			●					●
	3K			●	●						●	●	●	●		●	●		●	●		●
	4K				●					●	●	●	●	●		●	●		●	●		●
	5K				●					●	●	●	●	●		●	●		●	●		●
	FF to 5F				●																	
2N to 5N				●																		
Rectangular	RR				●							●										
	0R				●							●	●									●
	1R				●							●	●									●
Screw	03		●		●																	
	0V	●	●		●		●															●
	1V	●	●	●	●		●															●
	2V	●	●	●	●		●	●				●										●
	3V	●	●	●	●		●	●		●		●	●									
	4V	●	●	●	●		●	●				●	●									
	5V	●			●					●	●	●	●									
	0W to 5W				●						●	●	●	●			●					●
	2U to 5U				●										●	●	●					
	0M to 2M				●																	

Note: ● = included in this catalog, ● = available but not included in this catalog.

LEMO's Push-Pull Self-Latching Connection System

This self-latching system is renowned worldwide for its easy and quick mating and unmating features. It provides absolute security against vibration, shock or pull on the cable, and facilitates operation in a very limited space.

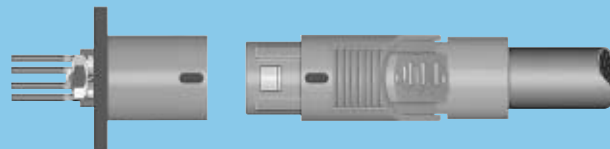

The plug and the receptacle can be mated by simply pushing axially the outer shell of the plug.



Pulling on the cable or any other component of the plug than the outer release sleeve cannot break the connection.

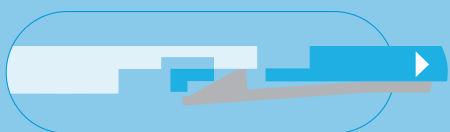

The connector can be unmated by a single axial pull on the plug outer release sleeve.

R Series Production Program

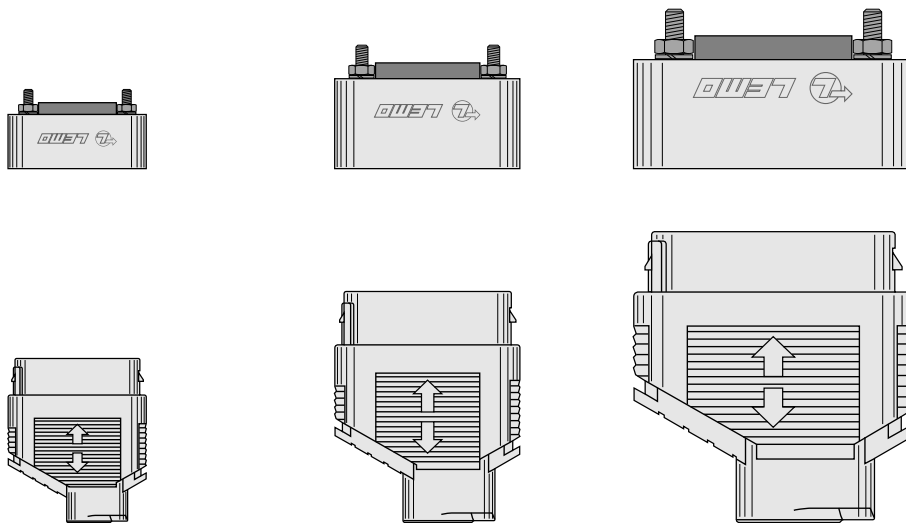

Series		RR	OR	1R
Cable ϕ range (mm)	min.	1.0	1.5	2.0
	max.	4.0	6.2	9.2
Number of contacts (multipole)		13	10, 17, 37	28, 36, 67
Number of contacts (mixed HV+LV)		-	4 HV + 4 LV, 2 HV + 13 LV	8 HV + 3 LV
Number of contacts (mixed coax+LV)		1 coax + 4 LV	4 coax + 4 LV, 2 coax + 13 LV	8 coax + 3 LV
Number of contacts (mixed fluidic+LV)		-	4 fluidic + 4 LV, 2 fluidic + 13 LV	8 fluidic + 3 LV

Note: «LV» stands for low voltage.

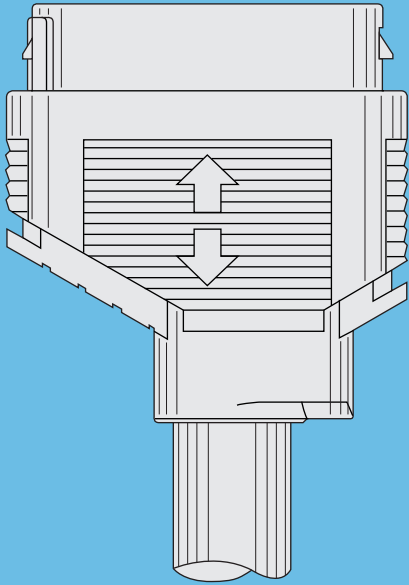
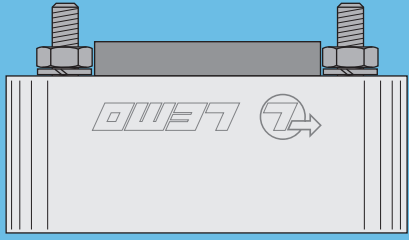

R SERIES

R Series

The R series is a rectangular connector with high pin density in a flat profile. It uses LEMO's well proven Push-Pull latching system for a smooth, hassle free connection. The ergonomic and flat profile offers high panel density, in a wide choice of colors for excellent visual aesthetics.

The R series is made of lightweight polyester resin Crastin® PBT from Dupont™. The high flexibility of its design enables various contact configuration, such as multipole, coaxial, high voltage and fluidic.

R series connectors provide the following main features:

- plastic shell for lightweight yet rugged structure
- push-pull latching enable fast and secure connections
- crimp or printed circuit contacts
- choice of 4 colors for aesthetics and quick identification
- high pin density for improved panel space
- 3 sizes and various models for design choices
- standard or hybrid pin configurations for flexibility
- thin footprint for reduced rack space and high density panel.

The R series, is initially designed to interconnect systems in medical application where aesthetics and safety is required. This connector series can also be used for test & measurement, aerospace and automotive testing, where an extensive number of contacts are needed in a limited space.

Plastic material used for manufacturing insulators is selected according to the required electric and thermal properties. The thermoplastic used is PEEK (Polyether-Etherketone) with the addition of glass fibers to improve mechanical characteristics and to increase dielectric strength.

Plastic housing models

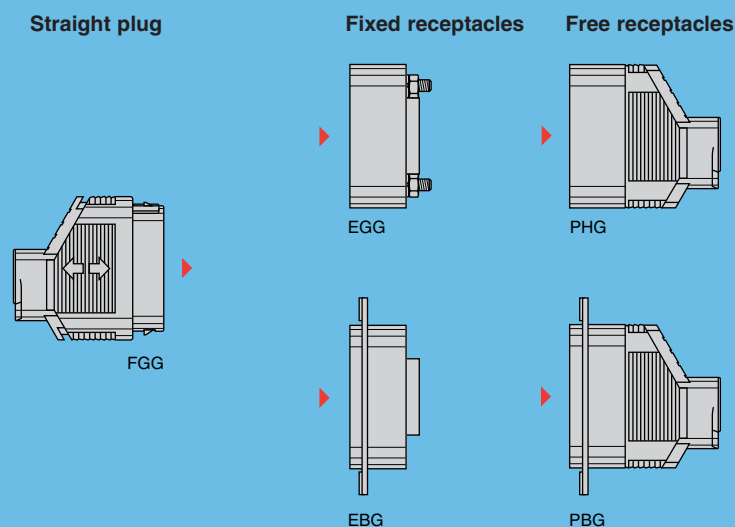

Part Numbering System

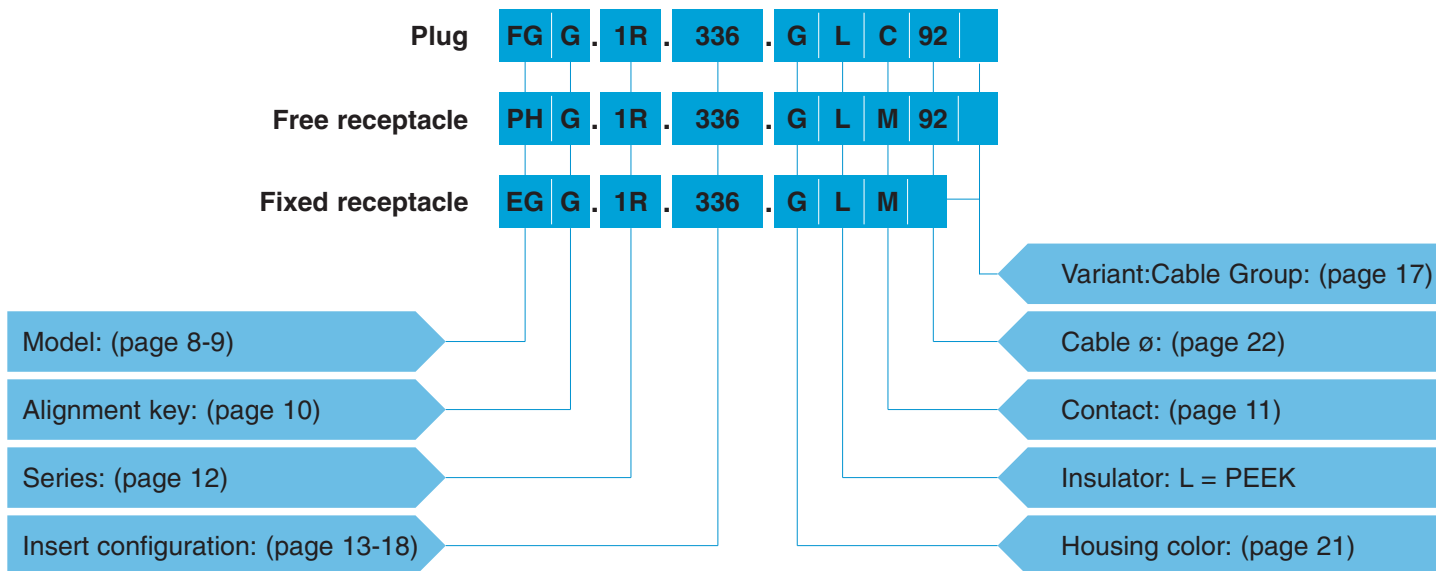

Part Number Example

Straight plug with cable collet:

FGG.1R.336.GLC92 = straight plug with key (G) and cable collet, 1R series, multipole type with 36 contacts, outer shell in gray PBT, PEEK insulator, male crimp contacts, collet for 9.2 mm maximum diameter cable.

Free receptacle:

PHG.1R.336.GLM92 = free receptacle with key (G) and cable collet, 1R series, multipole type with 36 contacts, outer shell in gray PBT, PEEK insulator, female crimp contacts, collet for 9.2 mm maximum diameter cable.

Fixed receptacle:

EGG.1R.336.GLM = fixed receptacle, nut fixing, with key (G), 1R series, multipole type with 36 contacts, outer shell in gray PBT, PEEK insulator, female crimp contacts.

Part Section Showing Internal Components

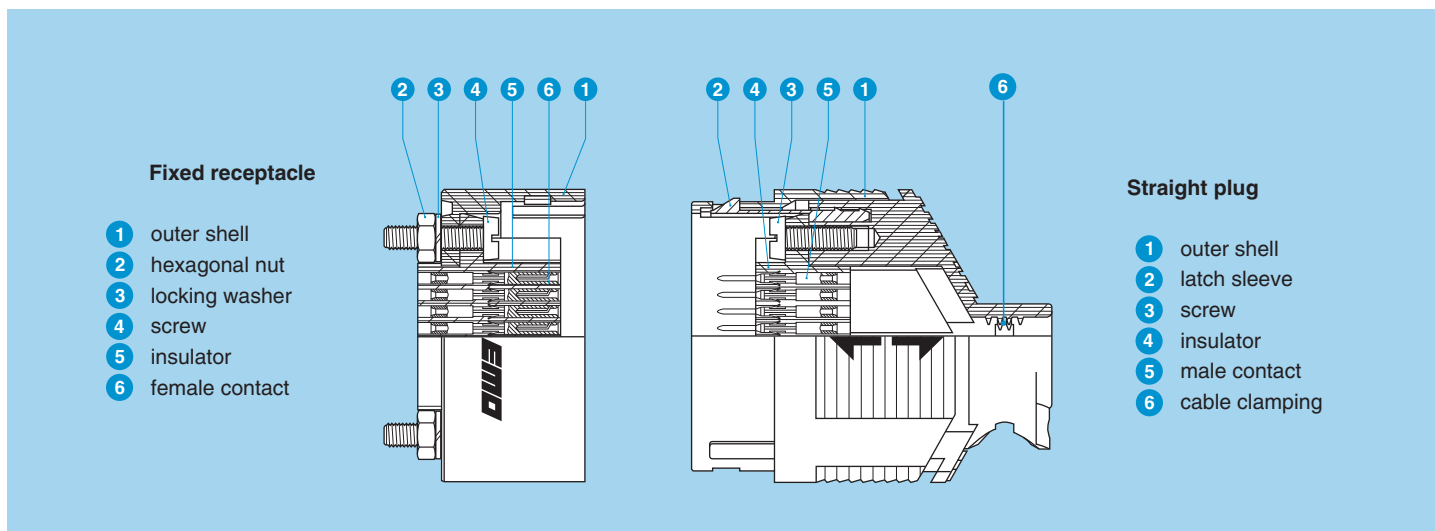



Housing models

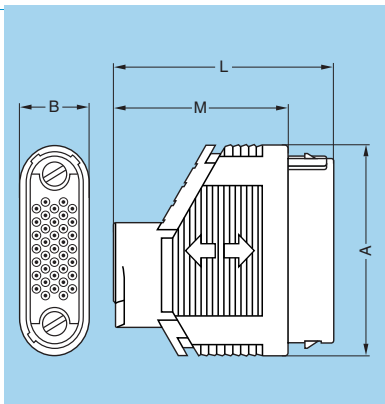
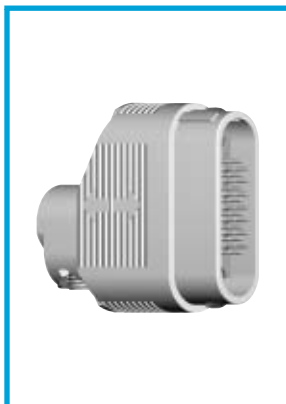

FGG Straight plug, key (G) or key (A), with cable collet

Reference		Dimensions (mm)			
Model	Series	A	B	L	M
FGG	RR	18.0	6.0	21.5	17.0
FGG	0R	24.5	9.0	30.5	23.5
FGG	1R	37.0	12.5	39.0	31.0

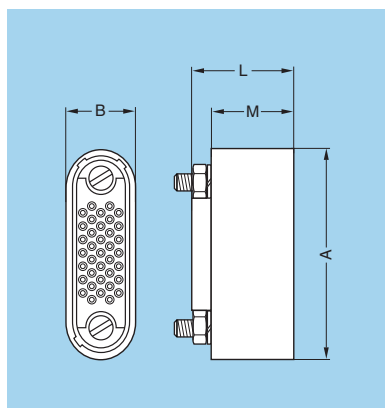

EGG Fixed receptacle, key (G) or key (A)

Reference		Dimensions (mm)			
Model	Series	A	B	L	M
EGG	RR	18.0	6.0	12.0	7.0
EGG	0R	24.5	9.0	14.0	12.0
EGG	1R	37.0	12.5	18.0	14.5

P1 Panel cut-out page 26)

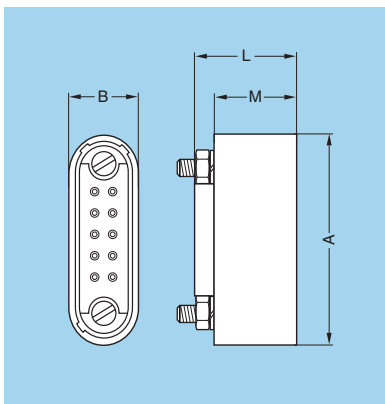
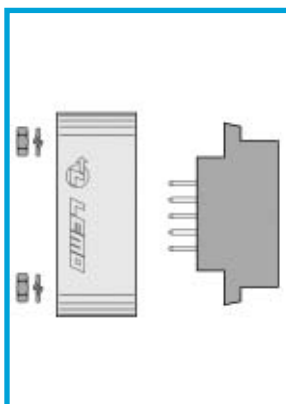

EGG Fixed socket, key (G) or key (A) with visible shell

Reference		Dimensions (mm)			
Model	Series	A	B	L	M
EGG	RR	18.0	6.0	12.0	7.0
EGG	0R	24.5	9.0	14.0	12.0
EGG	1R	37.0	12.5	18.0	14.5

P1 Panel cut-out page 26)

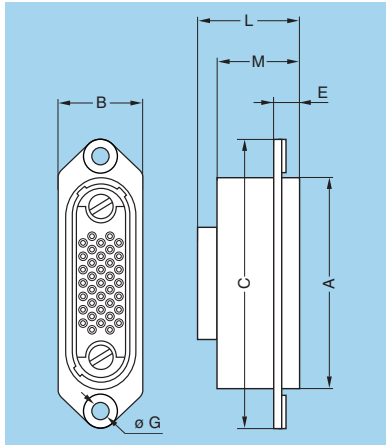

EBG Fixed receptacle, key (G) or key (A), with flange

Reference		Dimensions (mm)						
Model	Series	A	B	C	E	G	L	M
EBG	1R	37.0	15.0	51.0	4.5	3.2	19.5	14.5
EBG	0R	24.5	10.5	24.5	3.2	2.2	18.0	12.0

P2 Panel cut-out page 26

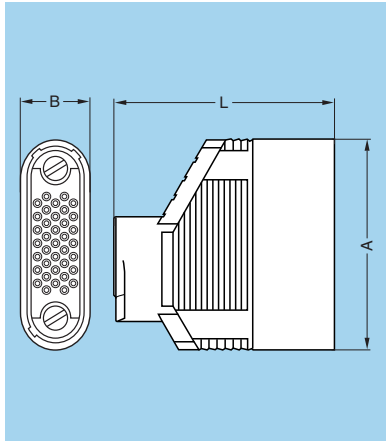

PHG Free receptacle, key (G) or key (A), with cable collet

Reference		Dimensions (mm)		
Model	Series	A	B	L
PHG	RR	18.0	6.0	22.3
PHG	0R	24.5	9.0	31.5
PHG	1R	37.0	12.5	39.0

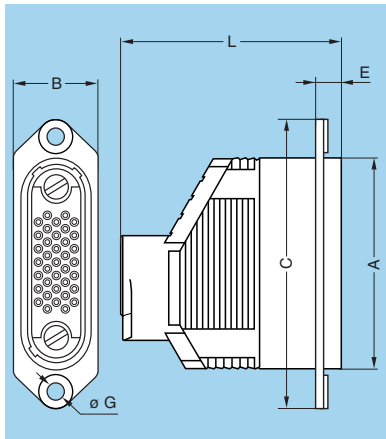
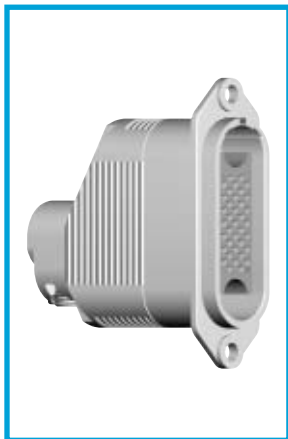

PBG Fixed receptacle, key (G) or key (A), with flange and cable collet

Reference		Dimensions (mm)						
Model	Series	A	B	C	E	G	L	
PBG	1R	37.0	15.0	51.0	4.5	3.2	39.0	
PBG	0R	24.5	10.5	34.5	3.2	2.2	31.5	

P2 Panel cut-out page 26

Alignment Key

Alignment Key and Polarized Keying System

R series connector model part numbers are composed of three letters. The LAST LETTER indicates the key position.

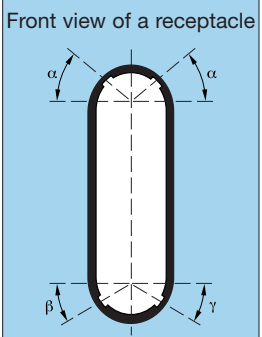
Front view of a receptacle 	Model	Nb of keys	Angles	Series			Contact type		Note
				RR	OR	1R	Plug	Receptacle	
				●●G	2	α	50°	50°	
			β	30°	30°	30°	male	female	●
●●A	2	α	42°	42°	42°	male	female	○	
		γ	30°	30°	30°	male	female	○	

- First choice alternative
- Special order alternative

Crimp Contacts

Contacts for plugs, free or fixed receptacles

Ref.	Contact type	Ref.	Contact type
C	Male crimp (fig. 1) ¹⁾	P	Female crimp (fig. 2) ¹⁾
B	Male crimp (fig. 2) ¹⁾	U	Female crimp (fig. 2) ¹⁾
G	Male crimp (fig. 2) ¹⁾	N	Female straight print
M	Female crimp (fig. 1) ¹⁾		

Note: ¹⁾ there are two forms of crimp barrels. Please consult adjacent table for contact selection

Dimension of crimp barrels







Contact			Ref. contact type		Conductor			
ø A (mm)	ø C (mm)	Form per fig.	Male	Female	AWG		Section (mm ²)	
					min.	max.	min.	max.
0.5	0.45	1	C	M	32	28	0.035	0.09
					26	22	0.140	0.34
0.7	0.80	1	C	M	32	28	0.035	0.09
	0.45	2	B	P	24	20	0.250	0.50
0.9	1.10	1	C	M	26	22	0.140	0.34
	0.80	2	B	P	32	28	0.035	0.09
	0.45	2	G	U				

Contacts reference for plugs, free or fixed receptacles

Contact type	Reference		Contact			Conductor			
	Male	Female	ø A (mm)	ø C (mm)	Form per fig.	Stranded			
						AWG		Section (mm ²)	
min.	max.	min.	max.						
<p style="text-align: center;">Crimp</p>	C	M	0.5	0.45	1	32	28	0.035	0.09
	C	M	0.7	0.80	1	26	22 ¹⁾	0.140	0.34
	B	P		0.45	2	32	28	0.035	0.09
	C	M	0.9	1.10	1	24	20	0.250	0.50
	B	P		0.80	2	26	22 ¹⁾	0.140	0.34
	G	U		0.45	2	32	28	0.035	0.09
<p style="text-align: center;">Print</p>	-	N	C dimensions are detailed in the section on PCB drilling pattern. See page 26.						

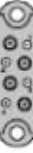
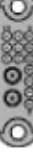
Note: ¹⁾ for a given AWG, the diameter of some stranded conductor designs is larger than the crimp barrel diameter. Make sure that the maximum conductor diameter is smaller than ø C.

Mixed / Hybrid Overview

Size	Ref	Number of LV Contacts	Diameter	Number of Hybrid Contact and Type	Insert
RR	804	4	0.5mm	1 coax, 50 ohm	
OR	004	4	0.7mm	4 pneumatic/fluidic 5 bars max pressure 3mm tube diameter	
OR	704	4	0.7mm	4 high voltage 2.7 kV rms (test volt) 7.5 kV dc (test volt)	
OR	804	4	0.7mm	4 coax, 50 ohms	
OR	813	13	0.7mm	2 coax, 50 ohm	
1R	703	3	0.9mm	8 high voltage 2.7 kV rms (test volt) 7.5 kV dc (test volt)	
1R	803	3	0.9mm	8 coax, 50 ohm	
1R	855	22 33	0.5mm 0.7mm	1 coax, 50 ohm	

Insert configuration

Multipole

	Male crimp contacts Female crimp contacts		Reference	Number of contacts	ø A (mm)	Contact type			Crimp contact Test voltage (kV rms) ¹⁾ Contact-contact	Rated current (A) ¹⁾
						Crimp	Print (straight)	Print (elbow)		
RR			313	13	0.5	●	●	-	0.6	0.5
OR			310	10	0.9	●	●	-	1.5	3.5
			317	17	0.7	●	●	●	1.35	2.0
			337	37	0.5	●	●	-	0.6	0.5
1R			328	28	0.9	●	●	-	1.5	3.0
			336	36	0.7	●	●	-	1.5	2.5
			365	65	0.5	●	●	-	0.6	0.5
			367	67	0.5	●	●	-	0.6	0.5

Mixed: High Voltage + Low Voltage

		Reference	High Voltage (HV)			Low Voltage (LV)					
Male HV contacts	Female HV contacts		Number of Contacts	Test voltage (kV dc) ¹⁾	Rated current (A)	Number of contacts	ø A (mm)	Crimp	Test voltage (kV rms) ¹⁾ Contact-contact	Rated Current (A) ¹⁾	
0R			704	4	7.5	2.0	4	0.7	●	1.35	2.0
			713	2	7.5	2.0	13	0.7	●	1.35	3.0
1R			703	8	7.5	2.0	3	0.9	●	1.5	3.5

Male

FGG.0R.403.ZLME15

**HV contact
Contact HT**



Female

EGG.0R.403.ZLCE15

**HV contact
Contact HT**



Typical Assembly of High Voltage Contact



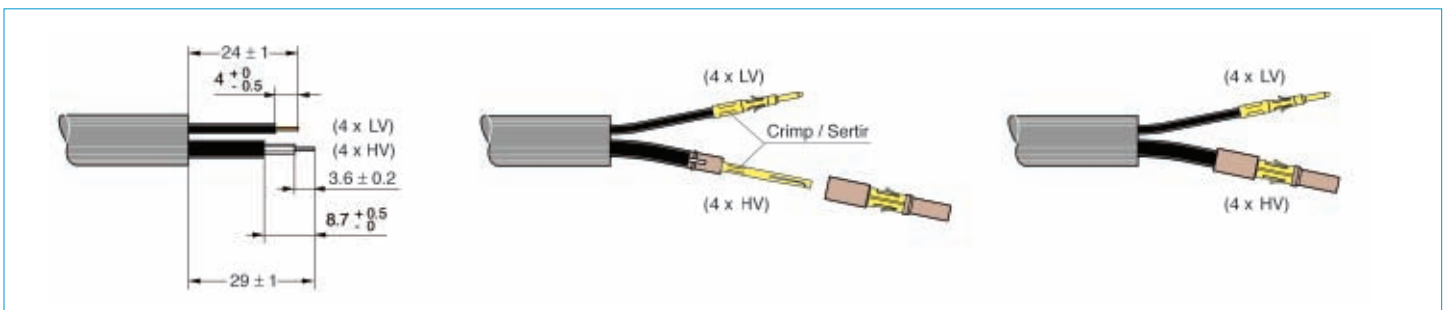

HV Contacts: Fit the HV sleeve onto the cable dielectric, check that all the HV conductor strands pass through the small hole.

Crimp the contact using tool DPC.91.701.V fitted with positioner DCE.91.051.BVCM, set to position 3. Fit by turning the HV sub-assembly on the HV sleeve and push until it butts. The two insulators should be at the same level.

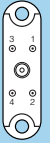
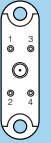

HV Contact	Conductor Range	26-28 AWG
HV Contact	Maximum Dielectric	1.5mm

Mixed Coax + Low Voltage

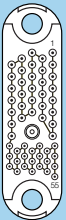
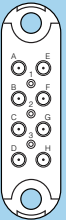
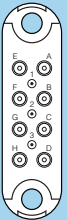
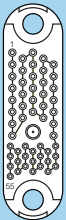
		Reference	Coax				Low voltage (LV)					
Male coax contacts	Female coax contacts		Number of contacts	Impedance (Ω)	Type	Cable group	Number of contacts	ϕ A (mm)	Crimp contact	Test voltage (kV rms) ¹⁾	Rated current (A) ¹⁾	
RR			804	1	0.5	RR	1	4	0.5	●	0.6	0.5
OR			804	4	50	OR	1	4	0.7	●	1.35	2
			813	2	50	OR	1	13	0.7	●	1.35	2
1R			803	8	50	1R	1	3	0.9	●	1.5	3
			855	1	50	1R	1	22 33	0.5 0.7	● ●	0.6 1.35	0.5 2.0

Male

FGG.0R.250.ZLME28

Coax contact
Contact coax



Female

EGG.0R.250.ZLCE28

Coax contact
Contact coax



Typical Assembly of Coax Contact (Coax Types - RG-174/U, RG-188 A/U, RG-316/U) = Cable Group 1

Coax contacts: Fit the crimp ferrule onto the cable. Crimp the contact using tool DPC.91.701.V fitted with positioner DCE.91.050.RVCM, set to position 3. Fit by turning the coax sub-assembly on the central contact until the stop is reached, check that the central contact is in the correct position in relation to the sub-assembly (0.5 mm), fold back the cable screen, place the crimp ferrule over the crimping area and complete the crimp using tool DPE.99.003.1K.

Male

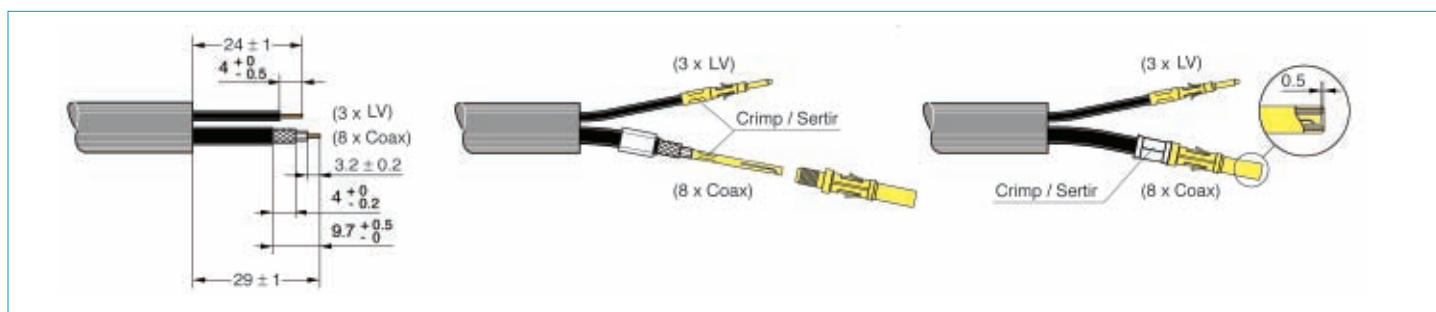

Female

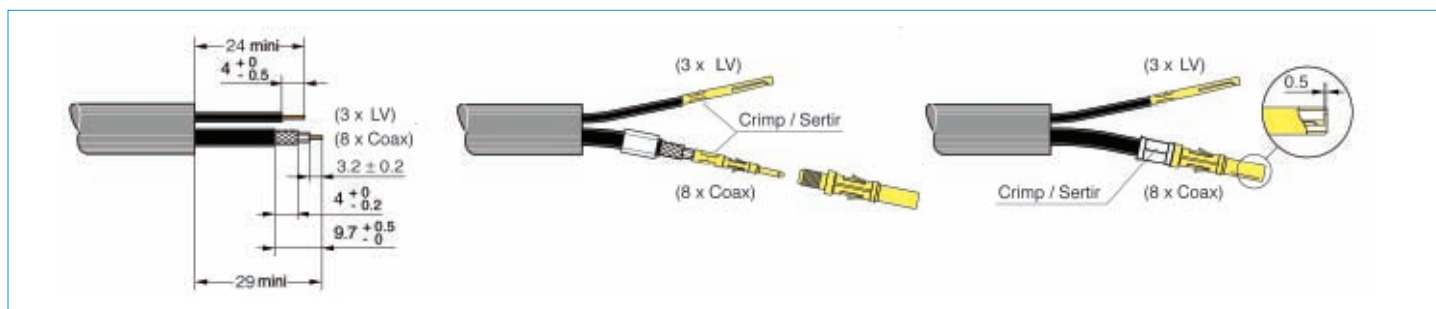

Typical Performance

VSWR / T.O.S.

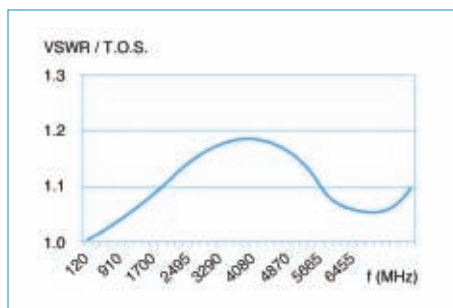

Mixed: Fluidic + Low Voltage

		Reference	Fluidic			Low voltage (LV)				
Male fluidic contacts	Female fluidic contacts		Number of contacts	Flow (l/min)	Operating pressure (bars)	Number of contacts	ø A (mm)	Crimp contact	Test voltage (kV rms) ¹⁾	Rated current (A) ¹⁾
0R		004	4	8	5	4	0.7	●	1.35	2.0
		013	2	8	5	13	0.7	●	1.35	2.0
1R		003	8	8	5	3	0.9	●	1.5	3.0



Fluidic / Pneumatic Contacts

Fluidic / pneumatic male contact

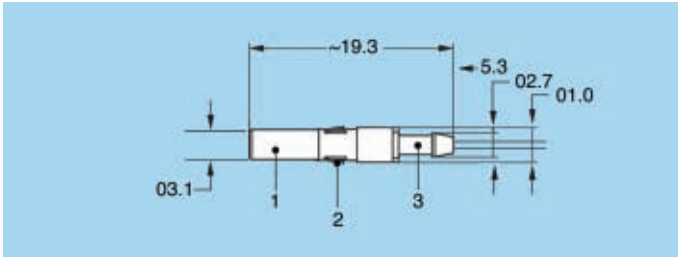

FGG.0R.010.AZ05 Male fluidic / pneumatic contact

Part number

FGG.0R.010.AZ05 (2.7mm hose barb and valve)

Note: 3 – Hose fitting/ barb, 2 – retaining clips, 1 – male sleeve

Fluidic / pneumatic male contact

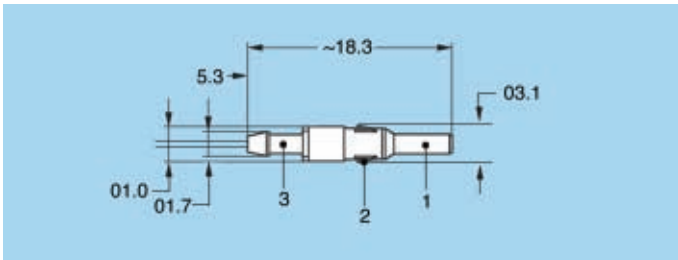

FGG.0R.010.AZL05 Male fluidic / pneumatic contact

Part number

FGG.0R.010.AZL05 (1.7mm hose barb and non-valve)

Note: 3 – Hose fitting/ barb, 2 – retaining clips, 1 – male sleeve

▶ **Fluidic / Pneumatic Contacts**

Fluidic / pneumatic female contact

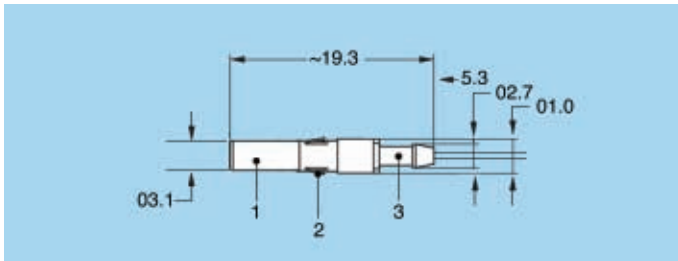

EGG.0R.010.AZ05 Female fluidic / pneumatic contact

Part number
EGG.0R.010.AZ05 (2.7mm hose barb and valve)

Note: 1 – female sleeve, 2 – retaining clips, 3 – Hose fitting/ barb,

Fluidic / pneumatic female contact

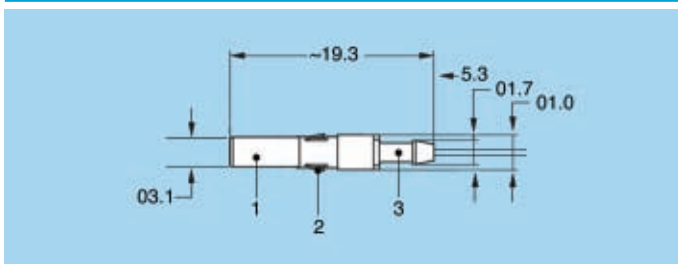

EGG.0R.010.AZL05 Female fluidic / pneumatic contact

Part number
EGG.0R.010.AZL05 (1.7mm hose barb and non-valve)

Note: 1 – female sleeve, 2 – retaining clips, 3 – Hose fitting/ barb,



Housings

Ref.	Color	RAL code
G	gray	7035
A	blue	6034
S	ochre	1028
V	green	6019

The exact color depends on manufacturing process and material pigments. For this reason some colors may differ from present RAL code.

Note: the connector shell material is Crastin® PBT.

Accessories



Collets

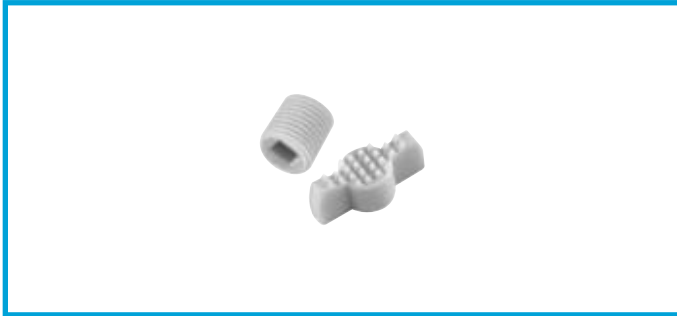

FGG Kit for cable clamping

Part number	Series	Collet size	min.	max.
FGG.RR.740.IZG	RR	40	1.0	4.0
FGG.0R.762.IZG	0R	62	1.6	6.2
FGG.1R.792.IZG	1R	92	2.0	9.2

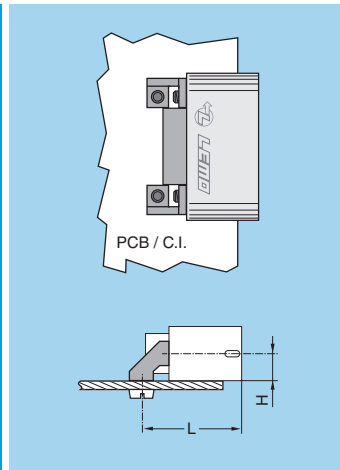

GEE Bracket

Part number	Series	Dimensions (mm)	
		L	H
GEE.RR.145.NZZ	RR	10.00	3.00
GEE.RR.146.NZZ		12.25	5.25
GEE.RR.147.NZZ		14.00	7.00
GEE.0R.145.NZZ	0R	16.50	4.50
GEE.0R.146.NZZ		18.25	6.25
GEE.0R.147.NZZ		22.50	10.50
GEE.1R.145.NZZ	1R	20.75	6.25
GEE.1R.146.NZZ		25.00	10.50
GEE.1R.147.NZZ		32.50	18.00

- Body material: Brass (UNS C 34500)
- Screws: Brass (UNS C 34500)

Spare parts



FGG-EGG Insulators for crimp contacts

	Type	Insulator part number	
		Male contact	Female contact
RR	313	FGG.RR.313.YL	EGG.RR.413.YL
OR	310	FGG.OR.310.YL	EGG.OR.410.YL
	317	FGG.OR.317.YL	EGG.OR.417.YL
	337	FGG.OR.337.YL	EGG.OR.437.YL
1R	328	FGG.1R.328.YL	EGG.1R.428.YL
	336	FGG.1R.336.YL	EGG.1R.436.YL
	365	FGG.1R.365.YL	EGG.1R.465.YL
	367	FGG.1R.367.YL	EGG.1R.467.YL

FGG-EGG Crimp contacts

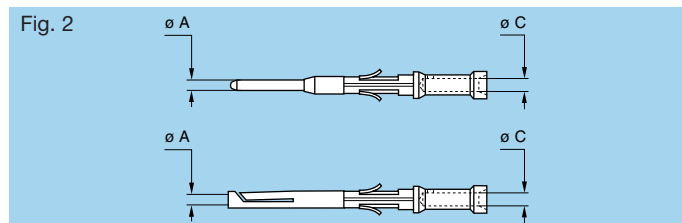
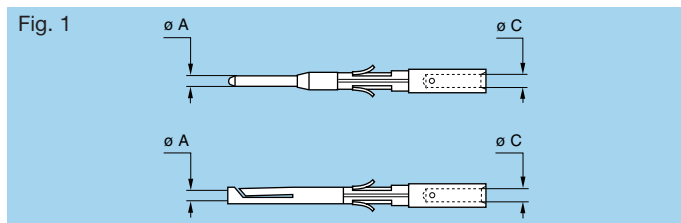

	Types	ø A (mm)	ø C (mm)	Contact part number	
				Male	Female
RR	313	0.5	0.45	FGG.00.554.ZZC	EGG.00.654.ZZM
OR	310	0.9	1.10	FGG.0B.560.ZZC	EGG.0B.660.ZZM
	317	0.7	0.80	FGG.0B.555.ZZC	EGG.0B.655.ZZM
	337	0.5	0.45	FGG.00.554.ZZC	EGG.00.654.ZZM
1R	328	0.9	1.10	FGG.0B.560.ZZC	EGG.0B.660.ZZM
	336	0.7	0.80	FGG.0B.555.ZZC	EGG.0B.655.ZZM
	365/367	0.5	0.45	FGG.0B.554.ZZC	EGG.1B.654.ZZM

	Types	ø A (mm)	ø C (mm)	Contact part number	
				Male	Female
OR	310	0.9	0.80	FGG.0B.561.ZZC	EGG.0B.661.ZZM
	310	0.9	0.45	FGG.0B.562.ZZC	EGG.0B.662.ZZM
	317	0.7	0.45	FGG.0B.556.ZZC	EGG.0B.656.ZZM
1R	328	0.9	0.80	FGG.0B.561.ZZC	EGG.0B.661.ZZM
	328	0.9	0.45	FGG.0B.562.ZZC	EGG.0B.662.ZZM
	336	0.7	0.45	FGG.0B.556.ZZC	EGG.0B.656.ZZM

Tooling

Manual crimping tools



Supplier	Part number
	contact \varnothing 0.5-0.7-0.9
LEMO	DPC.91.701.V ¹⁾
DANIELS	MH860 ¹⁾
ASTRO	616336 ¹⁾

¹⁾ According to specification MIL-C-22520/7-01.

DPE Manual crimping tool for coax contacts



Part number	Cable group
DPE.99.003.1K	1

DCE Positioners for crimp contacts \varnothing 0.5-0.7 and 0.9 mm

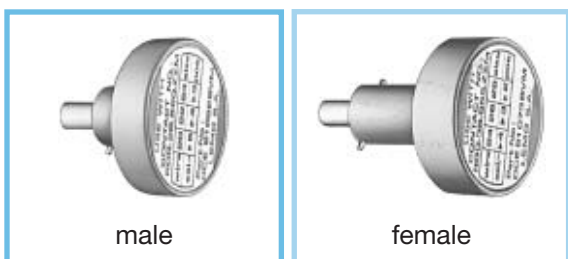

These positioners are suitable for use with both manual and pneumatic crimping tools according to the MIL-C-22520/7-01 standard.

	Connector + Contact					Positioners part number	
	Type	\varnothing A	\varnothing C	$\frac{L}{\varnothing}$	Conductor AWG	For male contact	For female contact
RR	313	0.5	0.45	1	28-30-32	DCE.91.050.0VC	DCE.91.050.0VM
		0.9	1.10	1	20-22-24	DCE.91.090.BVC	DCE.91.090.BVM
	310	0.9	0.80	2	22-24-26	DCE.91.090.AVC	DCE.91.090.AVM
		0.9	0.45	2	28-30-32	DCE.91.070.BVC	DCE.91.070.BVM
317	0.7	0.80	1	22-24-26	DCE.91.070.BVC	DCE.91.070.BVM	
	0.7	0.45	2	28-30-32	DCE.91.050.0VC	DCE.91.050.0VM	
337	0.5	0.45	1	28-30-32	DCE.91.050.0VC	DCE.91.050.0VM	
1R	328	0.9	1.10	1	20-22-24	DCE.91.090.BVC	DCE.91.090.BVM
		0.9	0.80	2	22-24-26	DCE.91.090.AVC	DCE.91.090.AVM
	336	0.9	0.45	2	28-30-32	DCE.91.090.AVC	DCE.91.090.AVM
		0.7	0.80	1	22-24-26	DCE.91.070.BVC	DCE.91.070.BVM
	336	0.7	0.45	2	28-30-32	DCE.91.070.BVC	DCE.91.070.BVM
		0.7	0.45	2	28-30-32	DCE.91.050.BVC	DCE.91.051.BVM
365/367	0.5	0.45	1	28-30-32	DCE.91.050.BVC	DCE.91.051.BVM	

Note: a wide variation of strand number and diameter combinations are quoted as being AWG, some of which do not have a large enough cross section to guarantee a crimp as per either MIL-C-22520/1-01 or /7-01. Our technical department is at your disposal to study and propose a solution to all your applications.

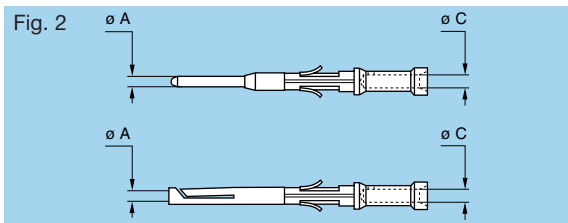
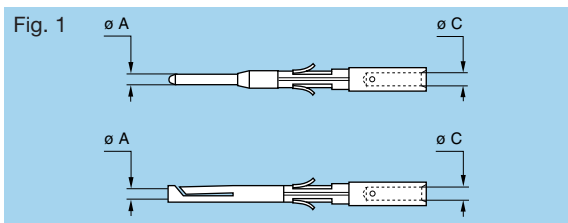

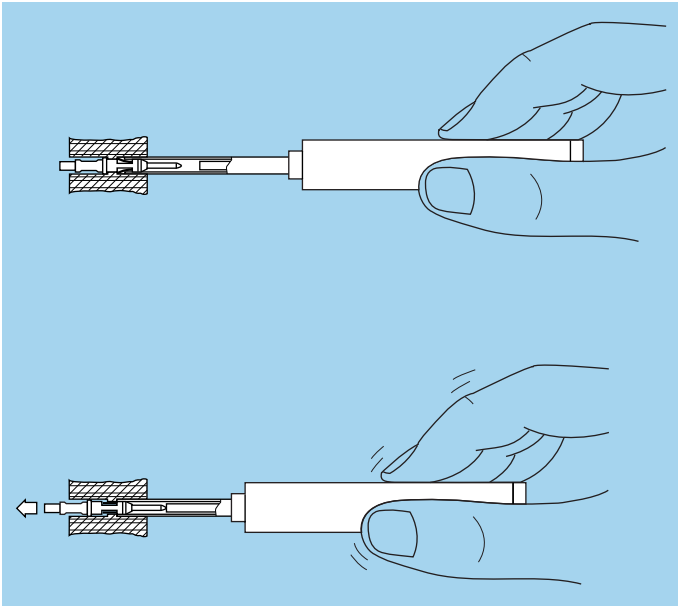
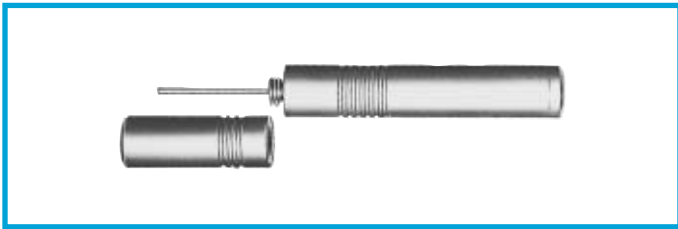

DCF Extraction tools for crimp contacts

	Connector		Extractors
	Type	Contact ø A	Part number
RR	313	0.5	DCF.91.050.2LT
	310	0.9	DCF.91.090.2LT
0R	317	0.7	DCF.91.070.2LT
	337	0.5	DCF.91.050.2LT
1R	328	0.9	DCF.91.090.2LT
	336	0.7	DCF.91.070.2LT
	365/367	0.5	DCF.91.050.2LT

Note: this model is used for male and female contacts.

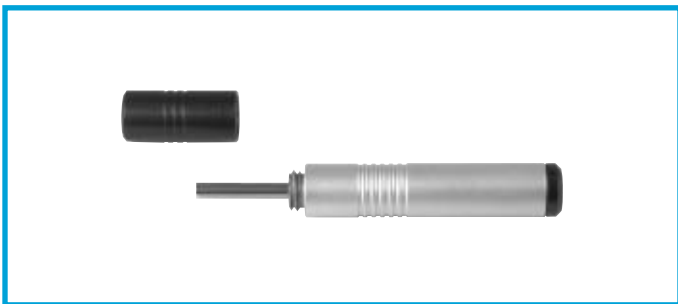

DCF Extraction tools for coax or HV contacts

Part number	Series
DCF.91.215.1LT	RR
DCF.91.270.1LT	0R
DCF.91.270.1LT	1R



DCT Cable clamping tool

Part number	Series
DCT.91.165.PR	RR
DCT.91.205.PR	0R
DCT.91.205.PR	1R

- Material: translucent plastic and steel

Panel cut-outs

P1 - EGG

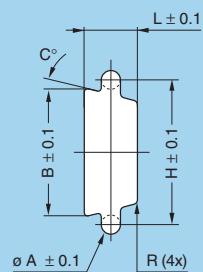

P2 - EBG, PBG

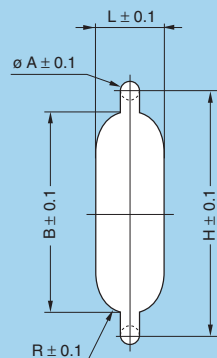

R series

Series	P1						P2				
	ø A	B	C	H	L	R	ø A	B	H	L	R
RR	1.7	7.8	5	11	3.5	-	-	-	-	-	-
OR	2.2	14.2	7	17	5.7	1.0	-	-	-	-	-
1R	3.2	22.2	10	25	8.5	1.2	3.2	37.4	45.0	12.8	6.4

PCB drilling pattern

Fixed receptacle with straight print contact (EGG models)

RR.313

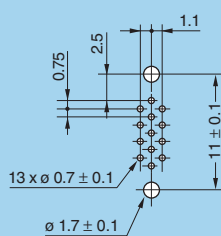

OR.310

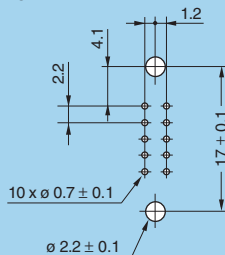

OR.317

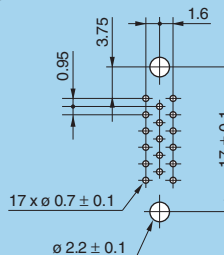

OR.337

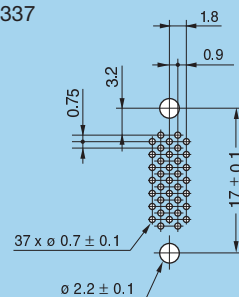

1R.328

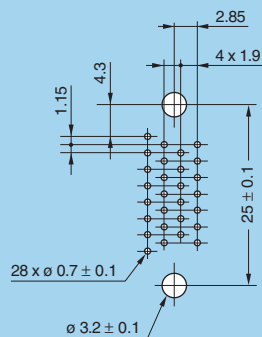

1R.336

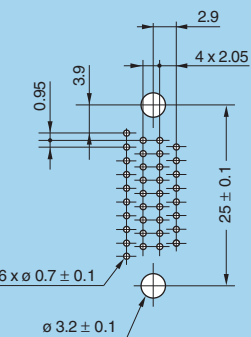

1R.365

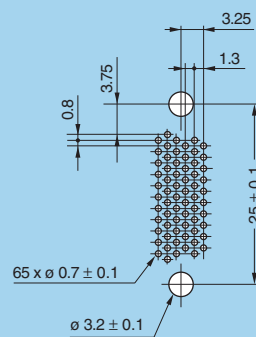

1R.855

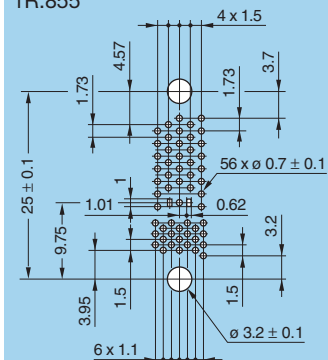

Fixed receptacle with straight print contact (EBG models)

1R.328

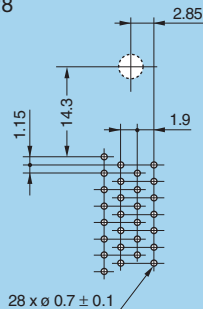

1R.336

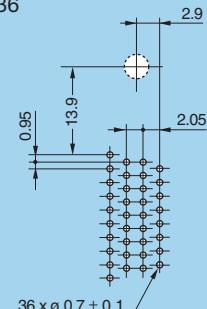

1R.365

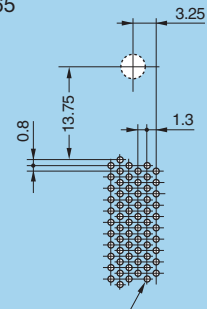

Technical characteristics

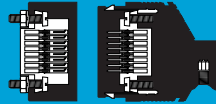

Outer shell

The R series is made of lightweight polyester resin Crastin® PBT from Dupont™ with metal latches.

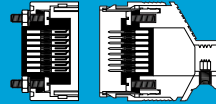

Insulator

The insulators are made of PEEK plastic. The insulators of the coax contact and the high voltage contact are Teflon™.

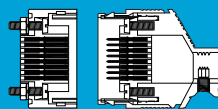

Electrical contact

Technical description

The secure reliable electromechanical connection achieved with LEMO female cylindrical contacts is mainly due to two important design features:

1. *Prod proof entry* on the mating side which ensures perfect concentric mating even with carelessly handled connectors.
2. *The pressure spring*, with good elasticity, maintains a constant even force on the male contact when mated. The leading edge of the pressure spring preserves the surface treatment (gold-plated) and prevents undue wear.

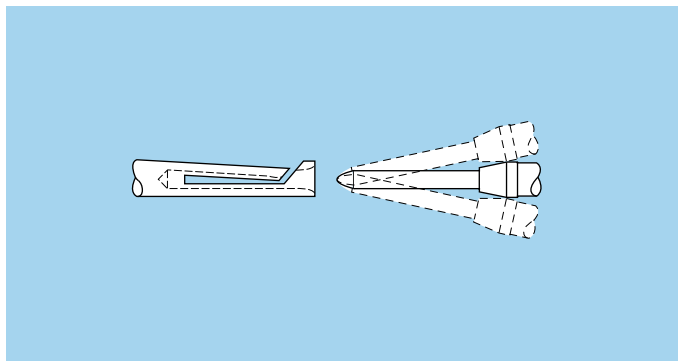

Contact material and treatment

LEMO female contacts are made of bronze beryllium (QQ-C-530) or bronze (UNS C 54400). These materials are chosen because of their high modulus of elasticity, their excellent electrical conductivity and a high mechanical strength.

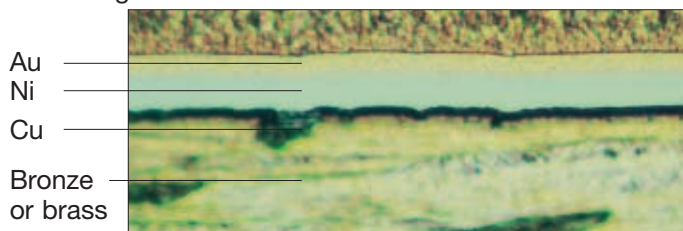

LEMO male solder and print contacts are made of brass (UNS C 38500). Male crimp contacts are made of brass (UNS C 34500) or annealed brass (UNS C 38500) with optimum hardness (HV) for crimping onto the wire.

Type	Material (standard)	Surf. treatment (µm)		
		Cu	Ni	Au ¹⁾
Male crimp	Brass (UNS C 34500)	0.5	3	1.0
	Brass (UNS C 38500)			
Male print	Brass (UNS C 38500)			
Female crimp	Bronze (UNS C 54400)	0.5	3	1.5
Female print	Cu-Be (FS QQ-C-530)			
Clips	Cu-Be (FS QQ-C-530)	-	-	-
	Stainless steel			
Wire ²⁾	Brass	-	3 ³⁾	-

Notes: the standard surface treatment are as follows:

- nickel: FS QQ-N-290A or MIL-C-26074C

- gold: ISO 4523.

¹⁾ minimum value

²⁾ for elbow print contacts

³⁾ treatment completed by 6 µm Sn-Pb tin-plating

Crimp contacts

The square form crimp method is used (MIL-C-22520F, class I, type 2) photo 1 for unipole contacts.

For multipole contacts the standard four identer crimp method is used, MIL-C-22520F, class I, type 1), photo 2. The crimp method requires a controlled compression to obtain a symmetrical deformation of the conductor strand and of the contact material. The radial hole in the side of the contact makes it possible to check whether the conductor is correctly positioned within the contact. A good crimping is characterized by only slightly reduced conductor section and practically no gap.

For optimum crimping of bronze or brass contacts they are annealed to relieve internal stress and reduce material hardening during the crimping process. Only the crimping zone is annealed with the help of an induction heating machine designed by the LEMO Research and Development Department (see photo 3).

Advantages of crimping

- practical, quick contact fixing outside the insulator
- possible use at high temperature
- no risk of heating the insulator during the conductor-contact fixing
- high tensile strength

Crimp contacts are available in standard version (form 1) for mounting maximum size conductors.

For some dimensions, these crimp contacts can be produced with reduced crimp barrels (form 2) for mounting reduced size conductors.



Crimp contacts

The crimp contacts can be with two forms: a standard crimp barrel for large conductors (see fig. 1) or with a reduced crimp barrel for smaller conductors (see fig. 2).

Fig. 1

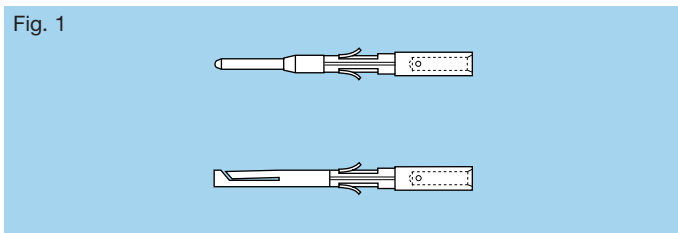

The range of cable dimensions that can be crimped into our contacts are indicated on the table on page 9.

Fig. 2

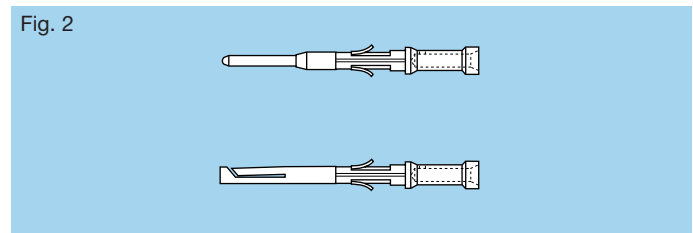

LEMO HEADQUARTERS

SWITZERLAND

LEMO SA

Chemin des Champs-Courbes 28 - P.O. Box 194 - CH-1024 Ecublens
Tel. (+41 21) 695 16 00 - Fax (+41 21) 695 16 01 - e-mail: info@lemo.com

LEMO SUBSIDIARIES

AUSTRIA

LEMO Elektronik GesmbH
Lemböckgasse 49/E6-3
1230 Wien
Tel: (+43 1) 914 23 20 0
Fax: (+43 1) 914 23 20 11
sales@lemo.at

CHINA

LEMO Trading (Shanghai) Co., Ltd.
LEMO Electronics (Shanghai) Co.,
Ltd.
5th Floor, Block 6, City of ELITE,
1000 Jinhai Road, Pudong
Shanghai, China 201206
Tel: (+86 21) 5899 7721
Fax: (+86 21) 5899 7727
cn.sales@lemo.com

DENMARK

LEMO DENMARK A/S
Gammel Mosevej 46
2820 Gentofte
Tel: (+45) 45 20 44 00
Fax: (+45) 45 20 44 01
info-dk@lemo.com

FRANCE

LEMO FRANCE Sàrl
15/19 Avenue Graham Bell
Espace Vinci-Bussy Saint Georges
77607 MARNE LA VALLEE Cedex 3
Tel: (+33 1) 6094 6094
Fax: (+33 1) 6094 6090
info-fr@lemo.com

GERMANY

LEMO Elektronik GmbH
Hanns-Schwindt-Str. 6
81829 München
Tel: (+49 89) 42 77 03
Fax: (+49 89) 420 21 92
info@lemo.de

HONG KONG

LEMO Hong Kong Ltd.
Room 33, 7th Floor
HITEC, 1 Trademart Drive
Kowloon Bay - Hong Kong
Tel: (+852) 21 74 04 68
Fax: (+852) 21 74 04 92
hk.sales@lemo.com

HUNGARY

REDEL Elektronika Kft
Vágóhid u. 26
1201 Budapest XX.
Tel: (+36 1) 421 47 10
Fax: (+36 1) 421 47 57
info-hu@lemo.com

LEMO USA, Inc.

800-444-5366
email: info@lemousa.com

www.lemo.com

ITALY

LEMO ITALIA srl
Viale Lunigiana 25, 20125 Milano
Tel: (+39 02) 66 71 10 46
Fax: (+39 02) 66 71 10 66
sales.it@lemo.com

JAPAN

LEMO JAPAN Ltd
4-10-3, Takaido Higashi,
Suginami-ku, Tokyo, 168-0072
Tel: (+81 3) 53 44 39 33
Fax: (+81 3) 53 44 39 35
lemoinfo@lemo.co.jp

NETHERLAND / BELGIUM

LEMO Connectors Nederland B.V.
De Trompet 2108
1967 DC Heemskerk
Tel: (+31 0) 251 25 78 20
Fax: (+31 0) 251 25 78 21
info@lemo.nl

NORWAY / ICELAND

LEMO NORWAY A/S
Stanseveien 6B, 0975 Oslo
Tel: (+47) 22 91 70 40
Fax: (+47) 22 91 70 41
info-no@lemo.com

SPAIN / PORTUGAL

IBERLEMO S.A.
Brasil, 45, 08402 Granollers
Barcelona
Tel: (+34 93) 860 44 20
Fax: (+34 93) 879 10 77
info-es@lemo.com

Madrid Office
Antonio López, 96
28019 Madrid
Tel: (+34 91) 469 99 19
Fax: (+34 91) 469 99 59

SWEDEN / FINLAND

LEMO Nordic AB
Mariehällsvägen 39A
168 65 Bromma
Tel: (+46 8) 635 60 60
Fax: (+46 8) 635 60 61
info-se@lemo.com

SWITZERLAND

LEMO VERKAUF AG
Grundstrasse 22B
6343 Rotkreuz
Tel: (+41 41) 790 49 40
Fax: (+41 41) 790 49 43
ch.sales@lemo.com

UNITED KINGDOM

LEMO UK Ltd
Unit 15 & 16
Hazelwood Trading Estate
Worthing, West Sussex, BN14 8NP
Tel: (+44 1903) 23 45 43
Fax: (+44 1903) 20 62 31
lemouk@lemo.com