

MC74HC1G04

Single Inverter

The MC74HC1G04 is a high speed CMOS inverter fabricated with silicon gate CMOS technology.

The internal circuit is composed of multiple stages, including a buffer output which provides high noise immunity and stable output.

The MC74HC1G04 output drive current is 1/2 compared to MC74HC series.

- High Speed: $t_{PD} = 7$ ns (Typ) at $V_{CC} = 5$ V
- Low Power Dissipation: $I_{CC} = 1$ μ A (Max) at $T_A = 25^\circ$ C
- High Noise Immunity
- Balanced Propagation Delays ($t_{pLH} = t_{pHL}$)
- Symmetrical Output Impedance ($I_{OH} = I_{OL} = 2$ mA)
- Chip Complexity: FET = 105
- NLV Prefix for Automotive and Other Applications Requiring Unique Site and Control Change Requirements; AEC-Q100 Qualified and PPAP Capable
- These Devices are Pb-Free and are RoHS Compliant

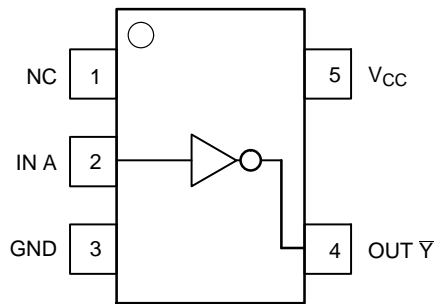

Figure 1. Pinout (Top View)

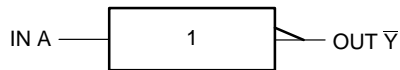

Figure 2. Logic Symbol



ON Semiconductor[®]

<http://onsemi.com>



SC-88A
(SC70-5/SOT-353)
DF SUFFIX
CASE 419A

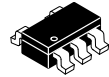

TSOP-5
DT SUFFIX
CASE 483

MARKING DIAGRAMS

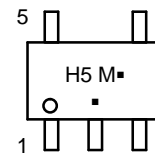

SC-88A

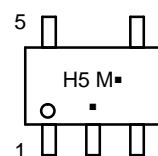

TSOP-5

H5 = Specific Device Code
M = Date Code
▪ = Pb-Free Package

(Note: Microdot may be in either location)

PIN ASSIGNMENT

PIN ASSIGNMENT	
1	NC
2	IN A
3	GND
4	OUT \bar{Y}
5	V_{CC}

FUNCTION TABLE

Input A	Output \bar{Y}
L	H
H	L

ORDERING INFORMATION

See detailed ordering and shipping information in the package dimensions section on page 4 of this data sheet.

MC74HC1G04

MAXIMUM RATINGS

Symbol	Parameter	Value	Unit
V _{CC}	DC Supply Voltage	-0.5 to +7.0	V
V _{IN}	DC Input Voltage	-0.5 to V _{CC} + 0.5	V
V _{OUT}	DC Output Voltage	-0.5 to V _{CC} + 0.5	V
I _{IK}	DC Input Diode Current	±20	mA
I _{OK}	DC Output Diode Current	±20	mA
I _{OUT}	DC Output Sink Current	±12.5	mA
I _{CC}	DC Supply Current per Supply Pin	±25	mA
T _{STG}	Storage Temperature Range	-65 to +150	°C
T _L	Lead Temperature, 1 mm from Case for 10 Seconds	260	°C
T _J	Junction Temperature Under Bias	+150	°C
θ _{JA}	Thermal Resistance	SC70-5/SC-88A (Note 1) TSOP-5 350 230	°C/W
P _D	Power Dissipation in Still Air at 85°C	SC70-5/SC-88A TSOP-5 150 200	mW
MSL	Moisture Sensitivity	Level 1	
F _R	Flammability Rating	Oxygen Index: 28 to 34 UL 94 V-0 @ 0.125 in	
V _{ESD}	ESD Withstand Voltage	Human Body Model (Note 2) Machine Model (Note 3) Charged Device Model (Note 4) > 2000 > 200 N/A	V
I _{LATCHUP}	Latchup Performance	Above V _{CC} and Below GND at 125°C (Note 5)	±500 mA

Stresses exceeding those listed in the Maximum Ratings table may damage the device. If any of these limits are exceeded, device functionality should not be assumed, damage may occur and reliability may be affected.

1. Measured with minimum pad spacing on an FR4 board, using 10 mm-by-1 inch, 2 ounce copper trace with no air flow.
2. Tested to EIA/JESD22-A114-A.
3. Tested to EIA/JESD22-A115-A.
4. Tested to JESD22-C101-A.
5. Tested to EIA/JESD78.

RECOMMENDED OPERATING CONDITIONS

Symbol	Parameter	Min	Max	Unit	
V _{CC}	DC Supply Voltage	2.0	6.0	V	
V _{IN}	DC Input Voltage	0.0	V _{CC}	V	
V _{OUT}	DC Output Voltage	0.0	V _{CC}	V	
T _A	Operating Temperature Range	-55	+125	°C	
t _r , t _f	Input Rise and Fall Time	V _{CC} = 2.0 V V _{CC} = 3.0 V V _{CC} = 4.5 V V _{CC} = 6.0 V	0 0 0 0	1000 600 500 400	ns

Functional operation above the stresses listed in the Recommended Operating Ranges is not implied. Extended exposure to stresses beyond the Recommended Operating Ranges limits may affect device reliability.

DEVICE JUNCTION TEMPERATURE VERSUS TIME TO 0.1% BOND FAILURES

Junction Temperature °C	Time, Hours	Time, Years
80	1,032,200	117.8
90	419,300	47.9
100	178,700	20.4
110	79,600	9.4
120	37,000	4.2
130	17,800	2.0
140	8,900	1.0

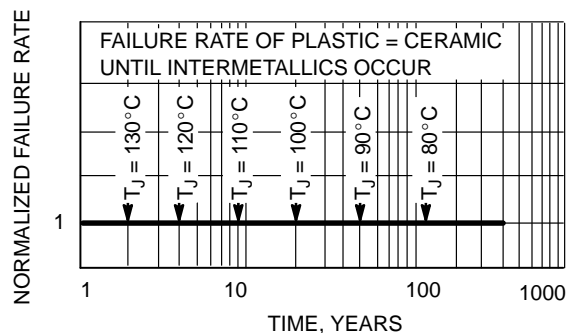

Figure 3. Failure Rate vs. Time Junction Temperature

MC74HC1G04

DC ELECTRICAL CHARACTERISTICS

Symbol	Parameter	Test Conditions	V _{CC} (V)	T _A = 25°C			T _A ≤ 85°C		-55°C ≤ T _A ≤ 125°C		Unit
				Min	Typ	Max	Min	Max	Min	Max	
V _{IH}	Minimum High-Level Input Voltage		2.0	1.5			1.5		1.5		V
			3.0	2.1			2.1		2.1		
			4.5	3.15			3.15		3.15		
			6.0	4.20			4.20		4.20		
V _{IL}	Maximum Low-Level Input Voltage		2.0			0.5		0.5		0.5	V
			3.0			0.9		0.9		0.9	
			4.5			1.35		1.35		1.35	
			6.0			1.80		1.80		1.80	
V _{OH}	Minimum High-Level Output Voltage V _{IN} = V _{IH} or V _{IL}	V _{IN} = V _{IH} or V _{IL} I _{OH} = -20 μA	2.0	1.9	2.0		1.9		1.9		V
			3.0	2.9	3.0		2.9		2.9		
		4.5	4.4	4.5		4.4		4.4			
		6.0	5.9	6.0		5.9		5.9			
V _{OL}	Maximum Low-Level Output Voltage V _{IN} = V _{IH} or V _{IL}	V _{IN} = V _{IH} or V _{IL} I _{OL} = 20 μA	2.0		0.0	0.1		0.1		0.1	V
			3.0		0.0	0.1		0.1		0.1	
		4.5		0.0	0.1		0.1		0.1		
		6.0		0.0	0.1		0.1		0.1		
V _{OL}	Maximum Low-Level Output Voltage V _{IN} = V _{IH} or V _{IL}	V _{IN} = V _{IH} or V _{IL} I _{OL} = 2 mA I _{OL} = 2.6 mA	4.5		0.17	0.26		0.33		0.40	V
			6.0		0.18	0.26		0.33		0.40	
I _{IN}	Maximum Input Leakage Current	V _{IN} = 6.0 V or GND	6.0			±0.1		±1.0		±1.0	μA
I _{CC}	Maximum Quiescent Supply Current	V _{IN} = V _{CC} or GND	6.0			1.0		10		40	μA

AC ELECTRICAL CHARACTERISTICS (Input t_r = t_f = 6.0 ns)

Symbol	Parameter	Test Conditions	T _A = 25°C			T _A ≤ 85°C		-55°C ≤ T _A ≤ 125°C		Unit	
			Min	Typ	Max	Min	Max	Min	Max		
t _{PLH} , t _{PHL}	Maximum Propagation Delay, Input A or B to Y	V _{CC} = 5.0 V C _L = 15 pF		3.5	15		20		25	ns	
			V _{CC} = 2.0 V C _L = 50 pF		18	100		125			155
				V _{CC} = 3.0 V	10	27		35			90
				V _{CC} = 4.5 V	7	20		25			35
				V _{CC} = 6.0 V	6	17		21			26
t _{TLH} , t _{THL}	Output Transition Time	V _{CC} = 5.0 V C _L = 15 pF		3	10		15		20	ns	
			V _{CC} = 2.0 V C _L = 50 pF		25	125		155			200
				V _{CC} = 3.0 V	16	35		45			60
				V _{CC} = 4.5 V	11	25		31			38
				V _{CC} = 6.0 V	9	21		26			32
C _{IN}	Maximum Input Capacitance		5	10		10		10	pF		

C _{PD}	Power Dissipation Capacitance (Note 6)	Typical @ 25°C, V _{CC} = 5.0 V		pF
		10		

6. C_{PD} is defined as the value of the internal equivalent capacitance which is calculated from the operating current consumption without load. Average operating current can be obtained by the equation: I_{CC(OPR)} = C_{PD} • V_{CC} • f_{in} + I_{CC}. C_{PD} is used to determine the no-load dynamic power consumption; P_D = C_{PD} • V_{CC}² • f_{in} + I_{CC} • V_{CC}.

MC74HC1G04

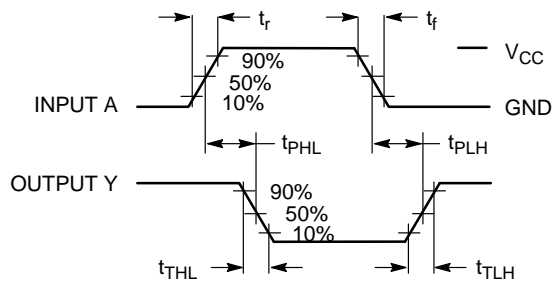
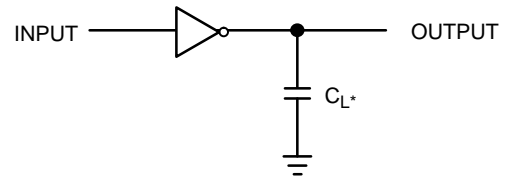

Figure 4. Switching Waveforms



*Includes all probe and jig capacitance.
A 1-MHz square input wave is recommended for propagation delay tests.

Figure 5. Test Circuit

DEVICE ORDERING INFORMATION

Device Order Number	Device Nomenclature						Package Type	Tape and Reel Size†
	Logic Circuit Indicator	Temp Range Identifier	Technology	Device Function	Package Suffix	Tape and Reel Suffix		
MC74HC1G04DFT1G	MC	74	HC1G	08	DF	T1	SC-88A (SC70-5/SOT-353) (Pb-Free)	178 mm (7 in) 3000 Unit
NLVHC1G04DFT1G*	NLV	74	HC1G	08	DF	T1	SC-88A (SC70-5/SOT-353) (Pb-Free)	178 mm (7 in) 3000 Unit
MC74HC1G04DFT2G	MC	74	HC1G	08	DF	T2	SC-88A (SC70-5/SOT-353) (Pb-Free)	178 mm (7 in) 3000 Unit
NLVHC1G04DFT2G*	NLV	74	HC1G	08	DF	T2	SC-88A (SC70-5/SOT-353) (Pb-Free)	178 mm (7 in) 3000 Unit
MC74HC1G04DTT1G	MC	74	HC1G	08	DT	T1	TSOP-5 (Pb-Free)	178 mm (7 in) 3000 Unit

†For information on tape and reel specifications, including part orientation and tape sizes, please refer to our Tape and Reel Packaging Specifications Brochure, BRD8011/D.

*NLV Prefix for Automotive and Other Applications Requiring Unique Site and Control Change Requirements; AEC-Q100 Qualified and PPAP Capable.

MC74HC1G04

PACKAGE DIMENSIONS

SC-88A (SC-70-5/SOT-353)
CASE 419A-02
ISSUE L

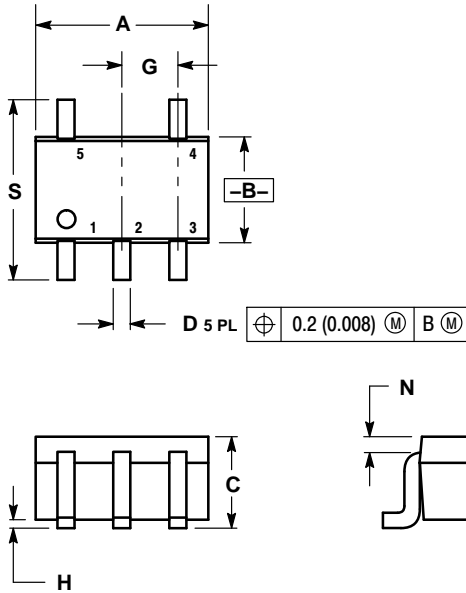

NOTES:

1. DIMENSIONING AND TOLERANCING PER ANSI Y14.5M, 1982.
2. CONTROLLING DIMENSION: INCH.
3. 419A-01 OBSOLETE. NEW STANDARD 419A-02.
4. DIMENSIONS A AND B DO NOT INCLUDE MOLD FLASH, PROTRUSIONS, OR GATE BURRS.

DIM	INCHES		MILLIMETERS	
	MIN	MAX	MIN	MAX
A	0.071	0.087	1.80	2.20
B	0.045	0.053	1.15	1.35
C	0.031	0.043	0.80	1.10
D	0.004	0.012	0.10	0.30
G	0.026 BSC		0.65 BSC	
H	---	0.004	---	0.10
J	0.004	0.010	0.10	0.25
K	0.004	0.012	0.10	0.30
N	0.008 REF		0.20 REF	
S	0.079	0.087	2.00	2.20

SOLDER FOOTPRINT*

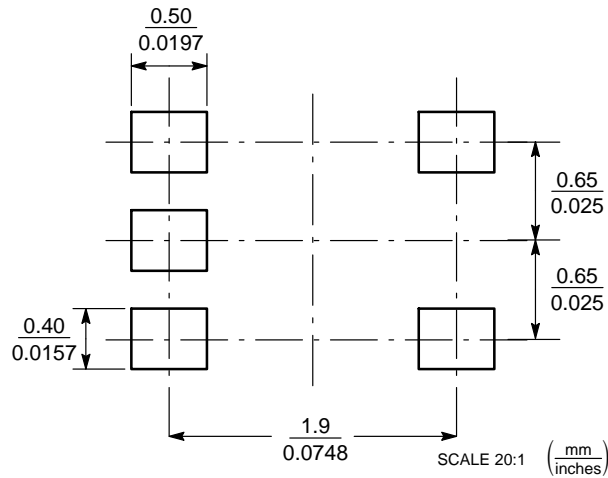

*For additional information on our Pb-Free strategy and soldering details, please download the ON Semiconductor Soldering and Mounting Techniques Reference Manual, SOLDERRM/D.

MC74HC1G04

PACKAGE DIMENSIONS

TSOP-5 CASE 483-02 ISSUE K

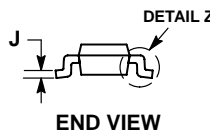
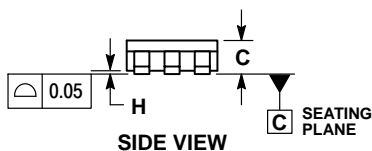
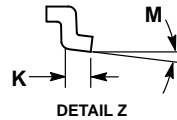
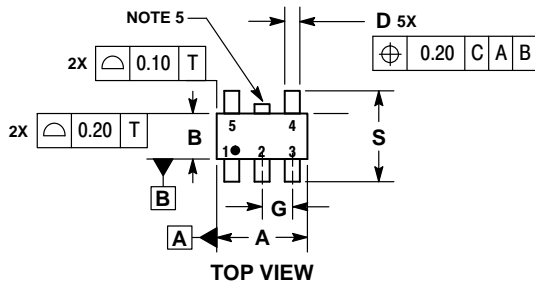

NOTES:

1. DIMENSIONING AND TOLERANCING PER ASME Y14.5M, 1994.
2. CONTROLLING DIMENSION: MILLIMETERS.
3. MAXIMUM LEAD THICKNESS INCLUDES LEAD FINISH THICKNESS. MINIMUM LEAD THICKNESS IS THE MINIMUM THICKNESS OF BASE MATERIAL.
4. DIMENSIONS A AND B DO NOT INCLUDE MOLD FLASH, PROTRUSIONS, OR GATE BURRS. MOLD FLASH, PROTRUSIONS, OR GATE BURRS SHALL NOT EXCEED 0.15 PER SIDE. DIMENSION A.
5. OPTIONAL CONSTRUCTION: AN ADDITIONAL TRIMMED LEAD IS ALLOWED IN THIS LOCATION. TRIMMED LEAD NOT TO EXTEND MORE THAN 0.2 FROM BODY.

DIM	MILLIMETERS	
	MIN	MAX
A	3.00 BSC	
B	1.50 BSC	
C	0.90	1.10
D	0.25	0.50
G	0.95 BSC	
H	0.01	0.10
J	0.10	0.26
K	0.20	0.60
M	0°	10°
S	2.50	3.00

SOLDERING FOOTPRINT*

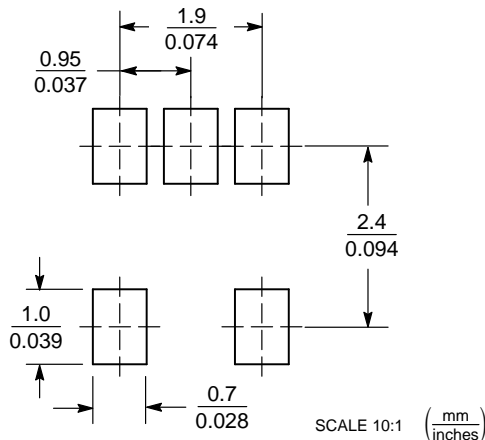

*For additional information on our Pb-Free strategy and soldering details, please download the ON Semiconductor Soldering and Mounting Techniques Reference Manual, SOLDERRM/D.

ON Semiconductor and the  are registered trademarks of Semiconductor Components Industries, LLC (SCILLC) or its subsidiaries in the United States and/or other countries. SCILLC owns the rights to a number of patents, trademarks, copyrights, trade secrets, and other intellectual property. A listing of SCILLC's product/patent coverage may be accessed at www.onsemi.com/site/pdf/Patent-Marking.pdf. SCILLC reserves the right to make changes without further notice to any products herein. SCILLC makes no warranty, representation or guarantee regarding the suitability of its products for any particular purpose, nor does SCILLC assume any liability arising out of the application or use of any product or circuit, and specifically disclaims any and all liability, including without limitation special, consequential or incidental damages. "Typical" parameters which may be provided in SCILLC data sheets and/or specifications can and do vary in different applications and actual performance may vary over time. All operating parameters, including "Typicals" must be validated for each customer application by customer's technical experts. SCILLC does not convey any license under its patent rights nor the rights of others. SCILLC products are not designed, intended, or authorized for use as components in systems intended for surgical implant into the body, or other applications intended to support or sustain life, or for any other application in which the failure of the SCILLC product could create a situation where personal injury or death may occur. Should Buyer purchase or use SCILLC products for any such unintended or unauthorized application, Buyer shall indemnify and hold SCILLC and its officers, employees, subsidiaries, affiliates, and distributors harmless against all claims, costs, damages, and expenses, and reasonable attorney fees arising out of, directly or indirectly, any claim of personal injury or death associated with such unintended or unauthorized use, even if such claim alleges that SCILLC was negligent regarding the design or manufacture of the part. SCILLC is an Equal Opportunity/Affirmative Action Employer. This literature is subject to all applicable copyright laws and is not for resale in any manner.

PUBLICATION ORDERING INFORMATION

LITERATURE FULFILLMENT:

Literature Distribution Center for ON Semiconductor
P.O. Box 5163, Denver, Colorado 80217 USA
Phone: 303-675-2175 or 800-344-3860 Toll Free USA/Canada
Fax: 303-675-2176 or 800-344-3867 Toll Free USA/Canada
Email: orderlit@onsemi.com

N. American Technical Support: 800-282-9855 Toll Free
USA/Canada
Europe, Middle East and Africa Technical Support:
Phone: 421 33 790 2910
Japan Customer Focus Center
Phone: 81-3-5817-1050

ON Semiconductor Website: www.onsemi.com

Order Literature: <http://www.onsemi.com/orderlit>

For additional information, please contact your local Sales Representative