





SMT POWER INDUCTORS

Shielded Drum Core - PL91XX Series



-  **Height:** 0.248 inches (6.3mm) Max
-  **Footprint:** 0.413 inches x 0.413 inches (10.5mm x 10.5mm) Max
-  **Inductance Range:** 0.96μH to 879μH
-  **Current Rating:** up to 10.5A

Electrical Specifications @ 25°C — Operating Temperature -55°C to +130°C

Part Numbers	Inductance @I _{rated} (μH TYP)	I _{rated} ² (A)	DCR (mΩ)		Inductance @0A _{dc} (μH)	Saturation ³ Current (A) @25°C	Heating ⁴ Current (A)
			TYP	MAX			
PL9101	0.96	10.5	3.2	4.5	1.0*	12.7	10.5
PL9102	1.52	9.5	3.9	5.5	1.8*	10.1	9.5
PL9103	2.34	7.8	5.5	7.8	2.7*	8.4	7.8
PL9104	3.27	6.7	7.7	11.0	3.9*	7.2	6.7
PL9105	4.39	5.6	11.0	15.6	5.1*	6.3	5.6
PL9106	5.54	5.2	12.6	18.0	6.8*	5.6	5.2
PL9107	6.73	5.0	14.0	20.0	8.2*	5.1	5.0
PL9108	8.19	4.6	16	22	10	4.6	4.8
PL9109	9.9	4.2	20	27	12	4.2	4.3
PL9110	13.4	3.6	22	30	15	3.6	4.0
PL9111	15.4	3.4	31	40	18	3.4	3.4
PL9112	17.6	3.2	35	45	22	3.2	3.2
PL9113	22.5	2.8	47	62	27	2.8	2.8
PL9114	28.5	2.5	53	70	33	2.5	2.6
PL9115	31.4	2.4	55	75	39	2.4	2.5
PL9116	38.4	2.2	76	100	47	2.2	2.2
PL9117	48.3	1.9	87	110	56	1.9	2.1
PL9118	55.9	1.8	95	120	68.0	1.8	2.0
PL9119	67.6	1.7	133	178	82.0	1.7	1.7
PL9120	86.1	1.4	175	230	100.0	1.4	1.5
PL9121	103	1.3	192	253	120.0	1.3	1.4
PL9122	121	1.2	216	280	150.0	1.2	1.3
PL9123	149	1.1	242	310	180.0	1.1	1.2
PL9124	186	1.0	318	400	220.0	1.0	1.05
PL9125	224	0.91	370	460	270	0.91	0.96
PL9126	279	0.82	520	690	330	0.82	0.84
PL9127	335	0.72	571	760	390	0.72	0.80
PL9128	398	0.68	638	850	470	0.68	0.77
PL9129	464	0.63	844	1060	560	0.63	0.66
PL9130	563	0.57	943	1200	680	0.57	0.63
PL9131	681	0.52	1054	1550	820	0.52	0.60
PL9132	879	0.46	1418	1750	1000	0.46	0.50

*Inductance at 0A_{dc} tolerance on indicated part numbers is ±30%; tolerance is ±20% on all other parts. Optional Tape & Reel packaging can be ordered by adding a "T" suffix to the part number (i.e. PL9101 becomes PL9101T).

NOTES FROM TABLE: (See back page)

Mechanical

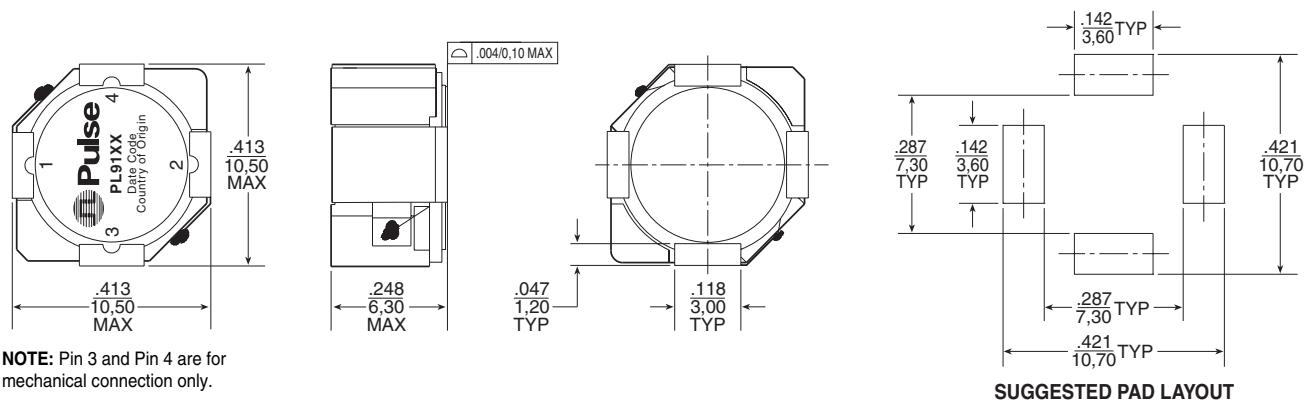

SMT POWER INDUCTORS

Shielded Drum Core - PL91XX Series



Notes from Tables

1. Temperature of the component (ambient plus temperature rise) must be within specified operating temperature range.
2. The rated current as listed is either the saturation current or the heating current depending on which value is lower.
3. The saturation current is the current which causes the inductance to drop to 75% of its initial inductance at zero bias. This current is determined by placing the component at room ambient (25°C), and applying a short duration pulse current (to eliminate self-heating effects) to the component.
4. The heating current is the DC current, which causes the temperature of the part to increase by approximately 40°C. This current is determined by extending the terminals of the component with 30mm length 28 gauge buss wires and applying the current to the device for 30 minutes. The temperature is measured by placing the thermocouple between the winding and the shield.
5. In high volt*time applications, additional heating in the component can occur due to core losses in the inductor which may necessitate derating the current in order to limit the temperature rise of the component. In order to determine the approximate total loss (or temperature rise) for a given application, both copper losses and core losses should be taken into account.

Schematic

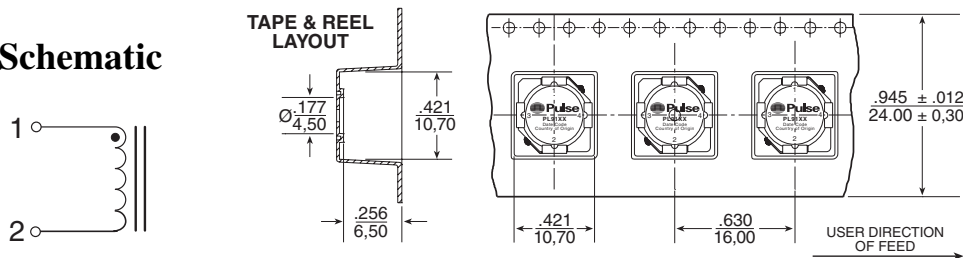

Weight 2.5 grams
 Tape & Reel 500/reel
 Dimensions: $\frac{\text{Inches}}{\text{mm}}$
 Unless otherwise specified,
 all tolerances are $\pm \frac{.010}{0,25}$

Inductance vs Current Characteristics

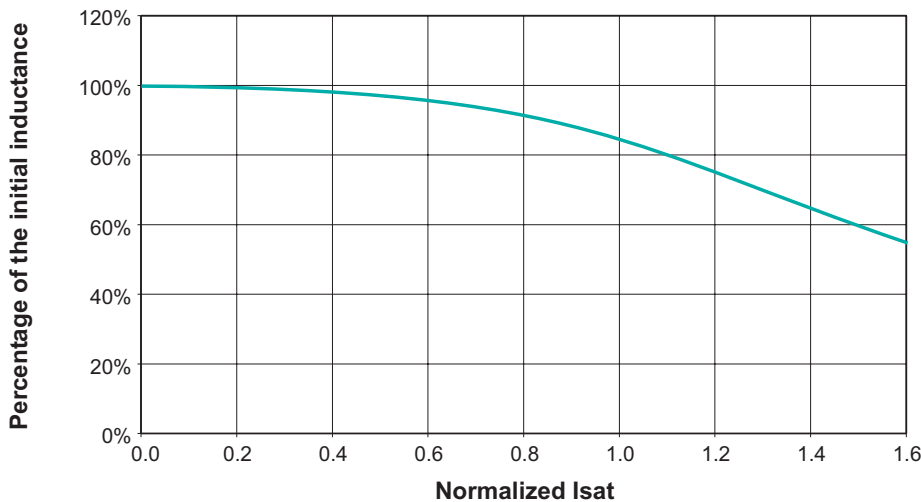

For More Information:

Pulse Worldwide Headquarters
 2 Pearl Buck Court
 Bristol, PA 19007
 U.S.A.
www.pulseeng.com

Pulse Europe
 Einsteinstrasse 1
 D-71083 Herrenberg
 Germany

Pulse China Headquarters
 B402, Shenzhen
 Tech-Innovation International
 Tenth Kejinan Rd.
 High-Tech Industrial Park
 Nanshan District, Shenzhen
 China
 Tel: 86 755 33966678
 Fax: 86 755 33966700

Pulse North China
 Room 1503
 XinYin Building
 No. 888 YiShan Rd.
 Shanghai 200233
 China
 Tel: 86 21 54643211/2
 Fax: 86 21 54643210

Pulse South Asia
 150 Kampong Ampat
 #07-01/02
 KA Centre
 Singapore 368324

Pulse North Asia
 No. 26
 Kao Ching Rd.
 Yang Mei Chen
 Taoyuan Hsien
 Taiwan, R. O. C.
 Tel: 886 3 4641811
 Fax: 886 3 4641911

Tel: 215 781 6400
 Fax: 215 781 6403

Tel: 49 7032 7806 0
 Fax: 49 7032 7806 12

Tel: 65 6287 8998
 Fax: 65 6280 0080

Performance warranty of products offered on this data sheet is limited to the parameters specified. Data is subject to change without notice. Other brand and product names mentioned herein may be trademarks or registered trademarks of their respective owners. © Copyright, 2007. Pulse Engineering, Inc. All rights reserved.