

THIS DRAWING IS UNPUBLISHED. RELEASED FOR PUBLICATION
 © COPYRIGHT - ALL RIGHTS RESERVED.

LOC	DIST	REVISIONS				
P	LTR	DESCRIPTION	DATE	DWN	APVD	
A1	-	F3	REVISED PER ECO-11-005140	16APR2011	RK	HMR

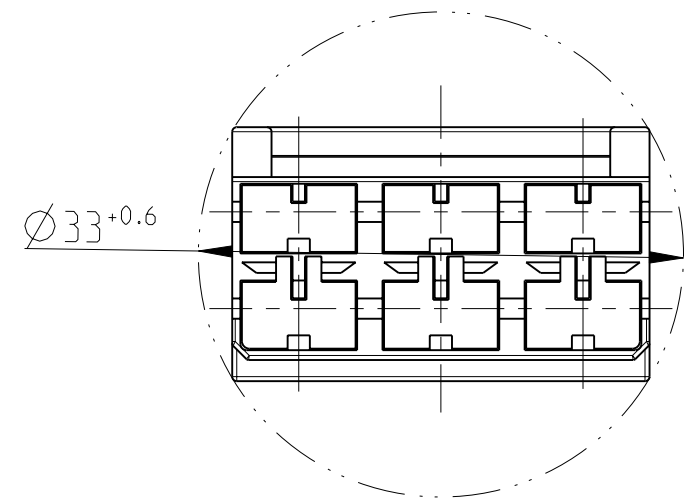

Schnitt Section A-A

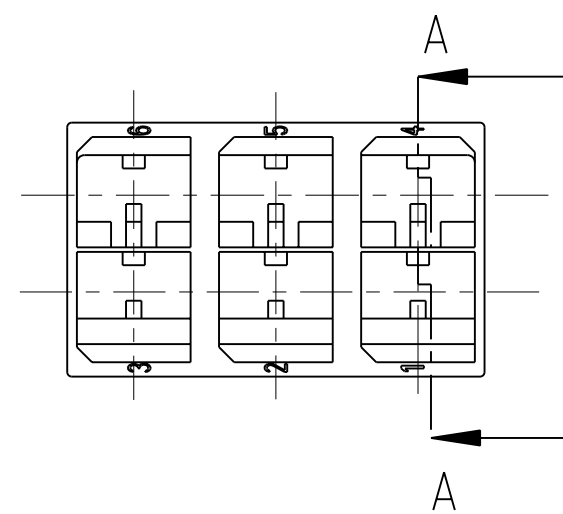
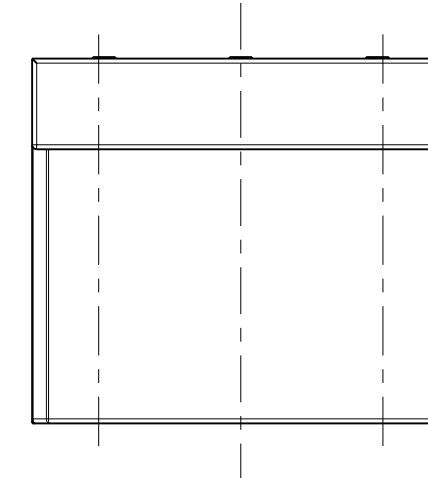
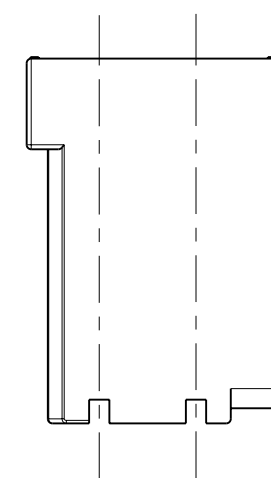
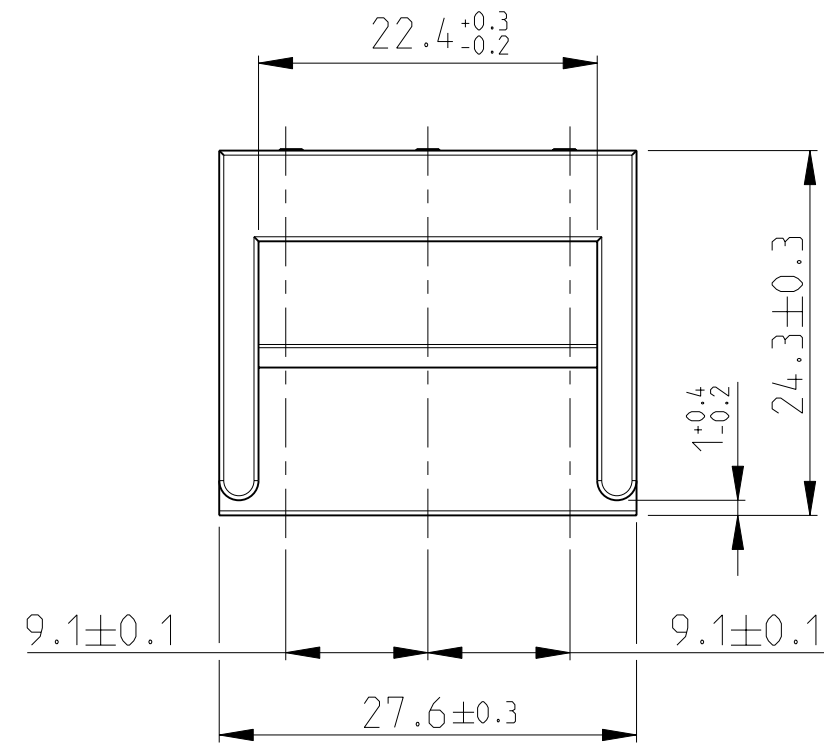
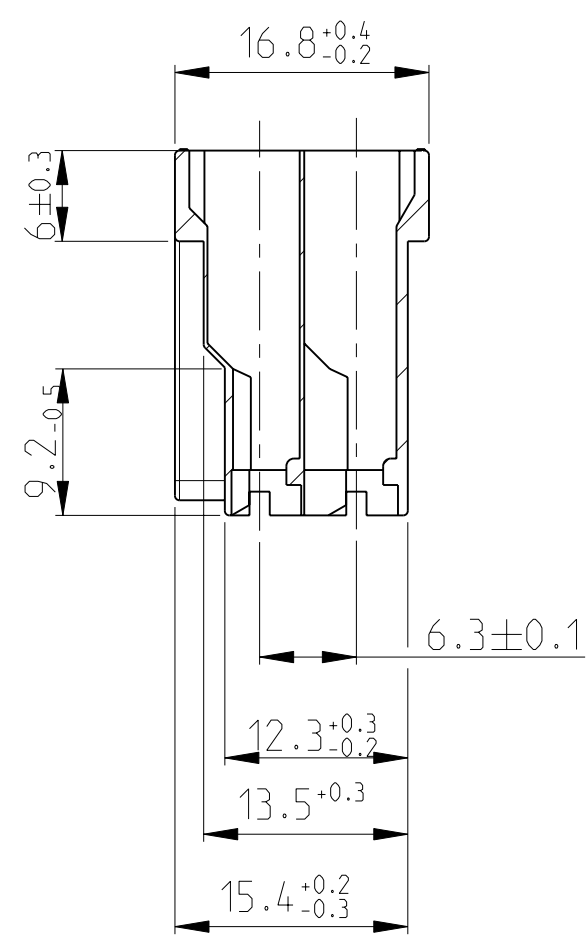

1:1

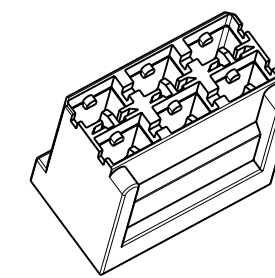

	weiß/ WHITE RAL 9001	PA 6.6	926330-8
3	OBSOLETE	blau/ BLUE RAL 5012	PA 6.6 -926330-7
	gelb/ YELLOW RAL 1018	PA 6.6	926330-6
3	OBSOLETE	grün/ GREEN RAL 6011	PA 6.6 -926330-5
	rot/ RED RAL 3000	PA 6.6	926330-4
	natur/ NARURAL	PA 6.6	926330-3
3	OBSOLETE	grau/ GREY RAL 7037	PA 6.6 -926330-2
	schwarz/ BLACK	PA 6.6	926330-1
	COLOR	MATERIAL	PARTNUMBER

Bemerkungen
NOTES:

1 Nicht vermaßte Wanddicken 1 ^{+0.2}/_{-0.4}
WALL THICKNESS 1 ^{+0.2}/_{-0.4} EXEPT AS NOTED

2 Nicht vermaßte Radien R0.3^{+0.2}
ALL RADII R0.3^{+0.2} EXEPT AS NOTED

3 OBSOLETE PARTS: OBSOLETE CIS STREAMLINING PER D.RENAUD/D.SINISI

THIS DRAWING IS A CONTROLLED DOCUMENT.		DWN Raab, S. 17SEP2008	TE Connectivity	
DIMENSIONS: mm		CHK Goepfel, C. 22SEP2008		
TOLERANCES UNLESS OTHERWISE SPECIFIED:		APVD Bleicher, M. 23SEP2008	NAME 6-poliges POSITIVE LOCK Gehäuse der Serie 6.3 (.250)	
Ø PLC ±0.2 1 PLC ±0.2 2 PLC ±0.2 3 PLC ±0.2 4 PLC ±0.2 ANGLES ±1.5° FINISH		PRODUCT SPEC -	SIZE A2	CAGE CODE 00779
MATERIAL -		APPLICATION SPEC -	DRAWING NO C-926330	RESTRICTED TO -
		WEIGHT 3.7 g	SCALE 2:1	SHEET 1 OF 1
		CUSTOMER DRAWING	REV F3	