

HDSP-301x/303x Series

HDSP-561x/563x Series

10 mm and 13 mm Slim Font Seven Segment Displays



Data Sheet



Description

These slim font seven segment displays incorporate a new slim font character design. This slim font features narrow width, specially mitered segments to give a fuller appearance to the illuminated character. Faces of these displays are painted a neutral gray for enhanced on/off contrast.

All devices are available in either common anode or common cathode configuration with right hand decimal point.

Features

- Excellent appearance
- Slim font design
- Mitered corners, evenly illuminated segments
- Gray face for optimum on/off contrast
- Choice of colors: HER, green, yellow, and AlGaAs
- Choice of character size: 10 mm and 13 mm
- Characterized for luminous intensity

Devices

HER HDSP-	Green HDSP-	Yellow HDSP-	AlGaAs HDSP-	Description
301E	301G	301Y	301A	Common Anode, 10 mm Display
303E	303G	303Y	303A	Common Cathode, 10 mm Display
561E	561G	561Y	561A	Common Anode, 13 mm Display
563E	563G	563Y	563A	Common Cathode, 13 mm Display

Part Numbering System

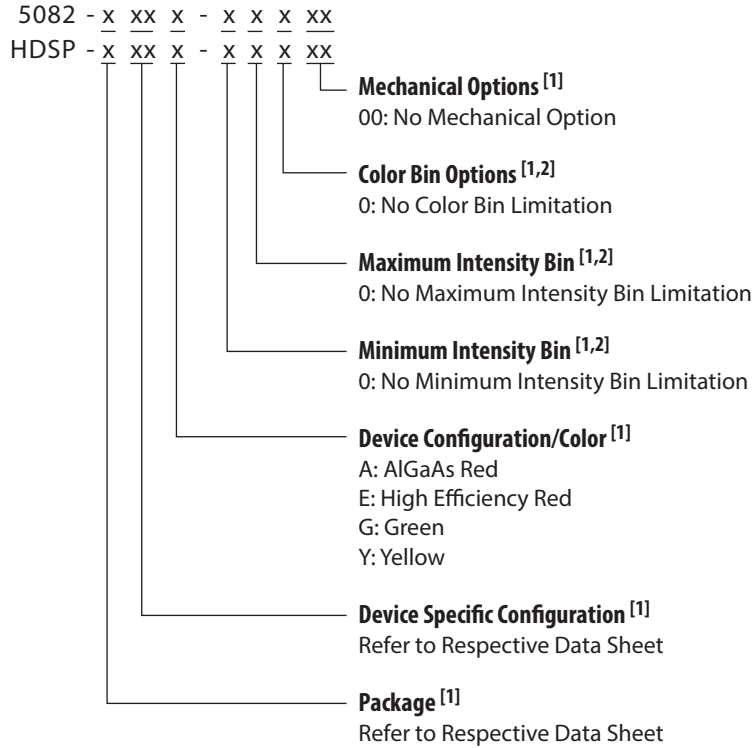

Notes:

1. For codes not listed in the figure above, please refer to the respective data sheet or contact your nearest Avago representative for details.
2. Bin options refer to shippable bins for a part-number. Color and Intensity Binbs are typically restricted to 1 bin per tube (exceptions may apply). Please refer to respective data sheet for specific bin limit information.

HDSP-301x/303x Series

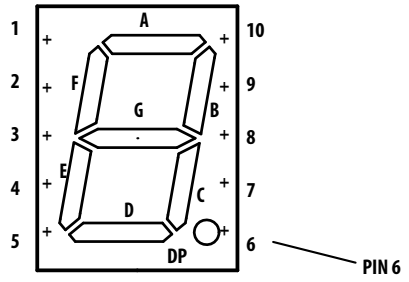
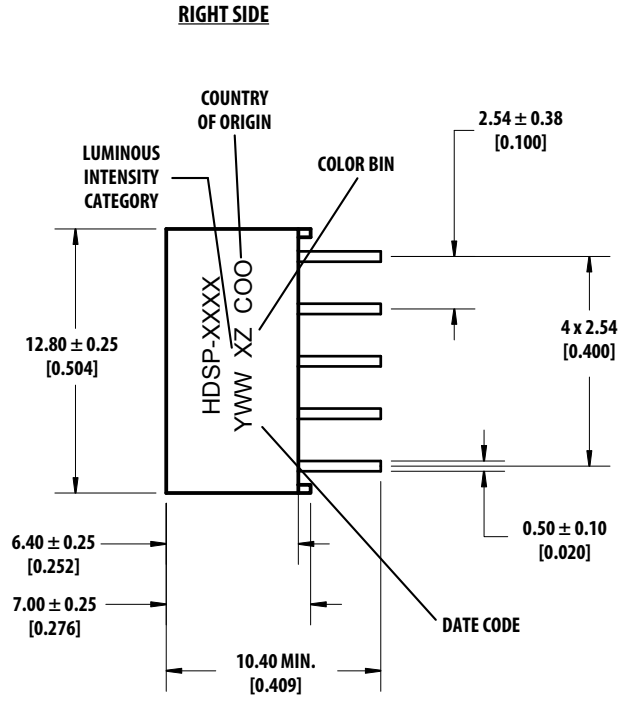
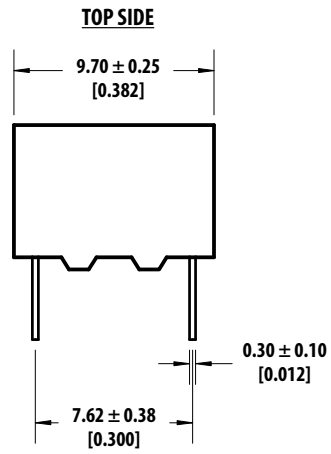
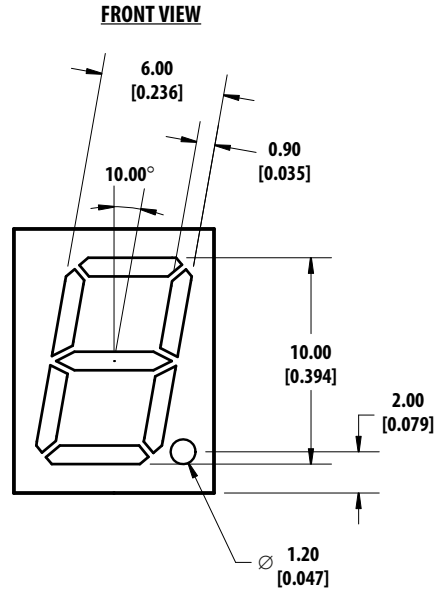

- Notes:
1. ALL DIMENSIONS ARE IN MILLIMETERS (INCHES).
2. TOLERANCE IS 0.25 mm (0.01 INCH) UNLESS OTHERWISE STATED.

Pin	Function
1	G
2	F
3	Common A/C
4	E
5	D
6	DP
7	C
8	Common A/C
9	B
10	A

HDSP-561x/563x Series

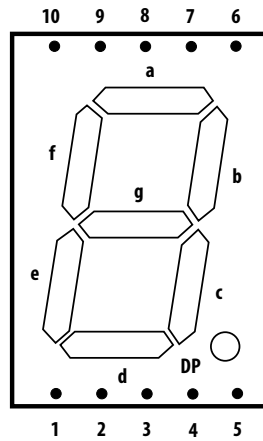
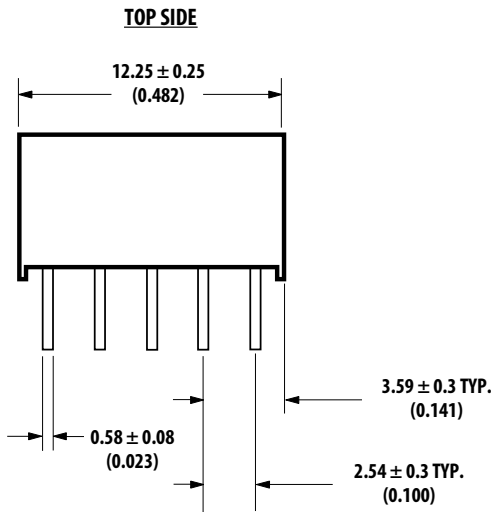
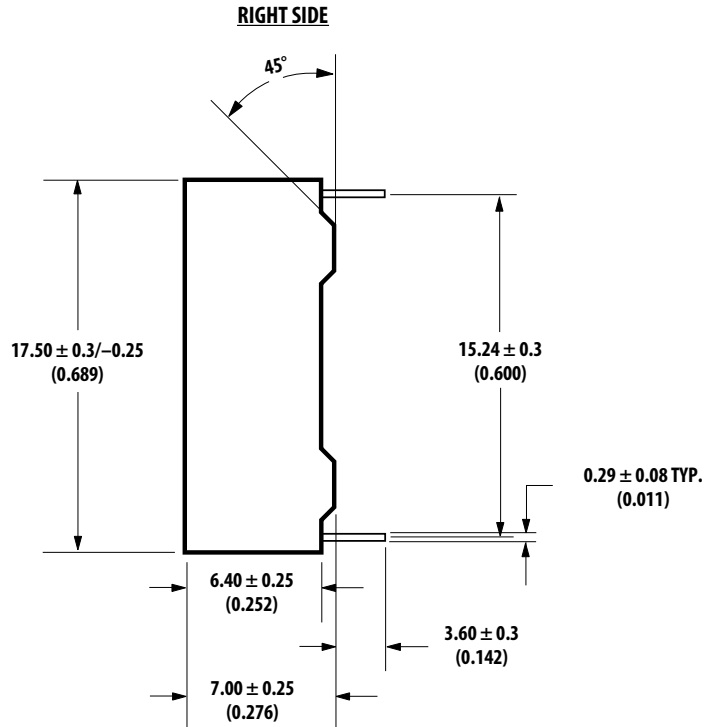
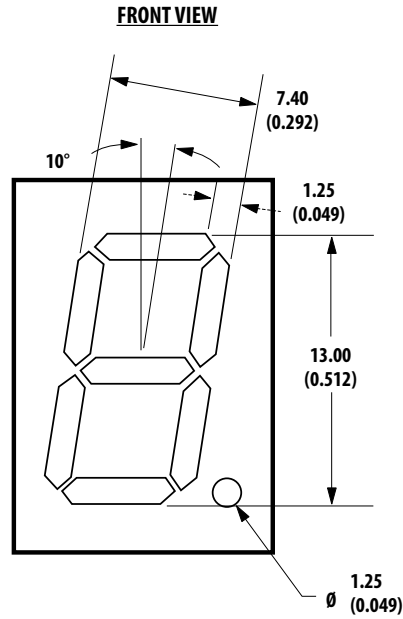

Notes:

1. ALL DIMENSIONS ARE IN MILLIMETERS (INCHES).
2. TOLERANCE IS 0.25 mm (0.01 INCH) UNLESS OTHERWISE STATED.

Pin	Function
1	E
2	D
3	Common A/C
4	C
5	DP
6	B
7	A
8	Common A/C
9	F
10	G

Absolute Maximum Ratings

Description	HER	Green	Yellow	AlGaAs	Units
Average Power per Segment or DP	105	105	105	37	mW
Peak Forward Current per Segment or DP	90	90	90	45	mA
DC Forward Current per Segment or DP	30	30	30	15	mA
Operating Temperature Range	-40 to +80	-40 to +80	-40 to +80	-20 to +80	°C
Storage Temperature Range	-40 to +80	-40 to +80	-40 to +80	-40 to +80	°C
Reverse Voltage per Segment or DP	5	5	5	5	V
Wavesoldering Temperature for 3 Seconds 1.59 mm below body	250	250	250	250	°C

Notes:

1. Derate above 33°C at 0.34 mA/°C for HER.
2. Derate above 27°C at 0.32 mA/°C for Green.
3. Derate above 30°C at 0.33 mA/°C for Yellow.
4. Derate above 60°C at 0.25 mA/°C for AlGaAs.

Electrical/Optical Characteristics at T_A = 25°C

HER

Device Series HDSP-301/303E

Parameter	Symbol	Min.	Typ.	Max.	Units	Test Conditions
Luminous Intensity/Segment (Digit Average)	I _V	1.100	1.800		mcd	I _F = 10 mA
Forward Voltage/Segment or DP	V _F		1.90	2.50	V	I _F = 20 mA
Peak Wavelength	λ _{PEAK}		635		nm	I _F = 20 mA
Dominant Wavelength	λ _d		625		nm	I _F = 20 mA
Reverse Current	I _R			100	μA	V _R = 5 V
Thermal Resistance LED Junction-to-Pin	R _{θJ-PIN}		351.5		°C/W/Seg.	

HER

Device Series HDSP-561/563E

Parameter	Symbol	Min.	Typ.	Max.	Units	Test Conditions
Luminous Intensity/Segment (Digit Average)	I _V	1.100	1.800		mcd	I _F = 10 mA
Forward Voltage/Segment or DP	V _F		1.90	2.50	V	I _F = 20 mA
Peak Wavelength	λ _{PEAK}		635		nm	I _F = 20 mA
Dominant Wavelength	λ _d		625		nm	I _F = 20 mA
Reverse Current	I _R			100	μA	V _R = 5 V
Thermal Resistance LED Junction-to-Pin	R _{θJ-PIN}		351.5		°C/W/Seg.	

Electrical/Optical Characteristics at T_A = 25° C (Cont.)**Green****Device Series HDSP-301/303G**

Parameter	Symbol	Min.	Typ.	Max.	Units	Test Conditions
Luminous Intensity/Segment (digit average)	I _V	1.800	2.800		mcd	I _F = 10 mA
Forward Voltage/Segment	V _F		2.25	2.50	V	I _F = 20 mA or DP
Peak Wavelength	λ _{PEAK}		568		nm	I _F = 20 mA
Dominant Wavelength	λ _d		573		nm	I _F = 20 mA
Reverse Current	I _R			100	μA	V _R = 5 V
Thermal Resistance LED Junction-to-Pin	Rθ _{J-PIN}		351.5		°C/W/Seg.	

Green**Device Series HDSP-561/563G**

Parameter	Symbol	Min.	Typ.	Max.	Units	Test Conditions
Luminous Intensity/Segment (Digit Average)	I _V	1.800	2.800		mcd	I _F = 10 mA
Forward Voltage/Segment or DP	V _F		2.25	2.50	V	I _F = 20 mA
Peak Wavelength	λ _{PEAK}		568		nm	I _F = 20 mA
Dominant Wavelength	λ _d		573		nm	I _F = 20 mA
Reverse Current	I _R			100	μA	V _R = 5 V
Thermal Resistance LED Junction-to-Pin	Rθ _{J-PIN}		351.5		°C/W/Seg.	

Yellow**Device Series HDSP-301/303Y**

Parameter	Symbol	Min.	Typ.	Max.	Units	Test Conditions
Luminous Intensity/Segment (Digit Average)	I _V	1.100	1.800		mcd	I _F = 10 mA
Forward Voltage/Segment or DP	V _F		2.15	2.50	V	I _F = 20 mA
Peak Wavelength	λ _{PEAK}		589		nm	I _F = 20 mA
Dominant Wavelength	λ _d		590		nm	I _F = 20 mA
Reverse Current	I _R			100	μA	V _R = 5 V
Thermal Resistance LED Junction-to-Pin	Rθ _{J-PIN}		351.5		°C/W/Seg.	

Electrical/Optical Characteristics at $T_A = 25^\circ\text{C}$ (Cont.)

Yellow

Device Series HDSP-561/563Y

Parameter	Symbol	Min.	Typ.	Max.	Units	Test Conditions
Luminous Intensity/Segment (Digit Average)	I_V	1.800	2.800		mcd	$I_F = 10\text{ mA}$
Forward Voltage/Segment or DP	V_F		2.15	2.50	V	$I_F = 20\text{ mA}$
Peak Wavelength	λ_{PEAK}		589		nm	$I_F = 20\text{ mA}$
Dominant Wavelength	λ_d		590		nm	$I_F = 20\text{ mA}$
Reverse Current	I_R			100	μA	$V_R = 5\text{ V}$
Thermal Resistance LED Junction-to-Pin	$R\theta_{\text{J-PIN}}$		351.5		$^\circ\text{C/W/Seg.}$	

Notes:

1. Typical specification for reference only. Do not exceed absolute maximum ratings.
2. The dominant wavelength, λ , is derived from the CIE chromaticity diagram and is that single wavelength which defines the color of the device.

AlGaAs

Device Series HDSP-301/303A

Parameter	Symbol	Min.	Typ.	Max.	Units	Test Conditions
Luminous Intensity/Segment (Digit Average)	I_V	0.280	0.450		mcd	$I_F = 1\text{ mA}$
Forward Voltage/Segment or DP	V_F		1.80	2.20	V	$I_F = 20\text{ mA}$
Peak Wavelength	λ_{PEAK}		660		nm	$I_F = 20\text{ mA}$
Dominant Wavelength	λ_d		643		nm	$I_F = 20\text{ mA}$
Reverse Current	I_R			100	μA	$V_R = 5\text{ V}$
Thermal Resistance LED Junction-to-Pin	$R\theta_{\text{J-PIN}}$		351.5		$^\circ\text{C/W/Seg.}$	

AlGaAs

Device Series HDSP-561/563A

Parameter	Symbol	Min.	Typ.	Max.	Units	Test Conditions
Luminous Intensity/Segment (Digit Average)	I_V	0.280	0.450		mcd	$I_F = 1\text{ mA}$
Forward Voltage/Segment or DP	V_F		1.80	2.20	V	$I_F = 20\text{ mA}$
Peak Wavelength	λ_{PEAK}		660		nm	$I_F = 20\text{ mA}$
Dominant Wavelength	λ_d		643		nm	$I_F = 20\text{ mA}$
Reverse Current	I_R			100	μA	$V_R = 5\text{ V}$
Thermal Resistance LED Junction-to-Pin	$R\theta_{\text{J-PIN}}$		351.5		$^\circ\text{C/W/Seg.}$	

Notes:

1. Typical specification for reference only. Do not exceed absolute maximum ratings.
2. The dominant wavelength, λ , is derived from the CIE chromaticity diagram and is that single wavelength which defines the color of the device.

Intensity Bin Limits (mcd)

Green

HDSP-301G/303G/561G/563G

IV Bin Category	Min.	Max.
K	1.800	3.600
L	2.800	5.600

Yellow

HDSP-301Y/303Y

IV Bin Category	Min.	Max.
I	1.100	2.200
K	1.800	3.600

Yellow

HDSP-561Y/563Y

IV Bin Category	Min.	Max.
K	1.800	3.600
L	2.800	5.600

HER

HDSP-301E/303E

IV Bin Category	Min.	Max.
I	1.100	2.200
K	1.800	3.600

AlGaAs Red

HDSP-301A/303A/561A/563A

IV Bin Category	Min.	Max.
F	0.280	0.560
G	0.450	0.900

HER

HDSP-561E/563E

IV Bin Category	Min.	Max.
K	2.001	3.2
L	3.201	5.05

Note: Tolerance is $\pm 10\%$

Color Categories

Color	Bin	Dominant Wavelength (nm)	
		Min.	Max.
Green	3	570.00	574.50
	4	567.00	571.50
Yellow	2	586.50	590.00
	3	584.00	587.50

Note:

1. All categories are established for classification of products. Products may not be available in all categories. Please contact your Avago representatives for further clarification/information.

HDSP-301x/303x Series

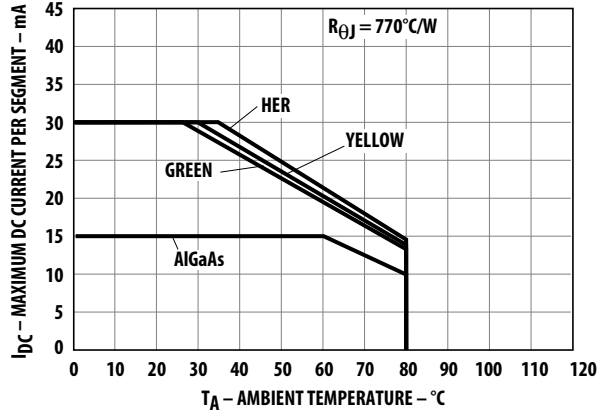

Figure 1. Maximum allowable DC current vs. ambient temperature.

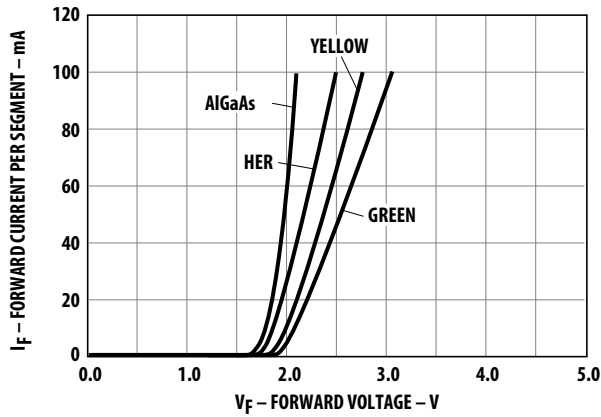

Figure 2. Forward current vs. forward voltage.

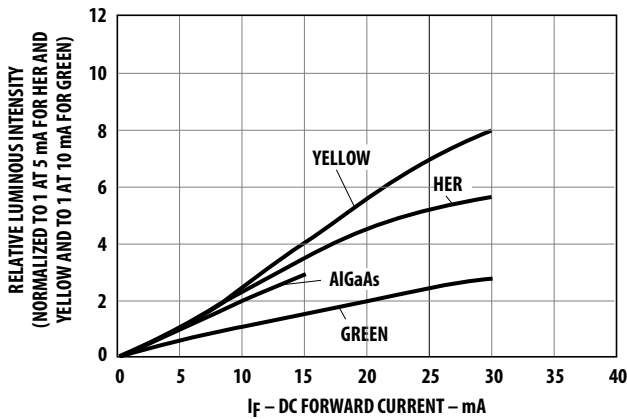

Figure 3. Relative luminous intensity vs. DC forward current.

HDSP-561x/563x Series

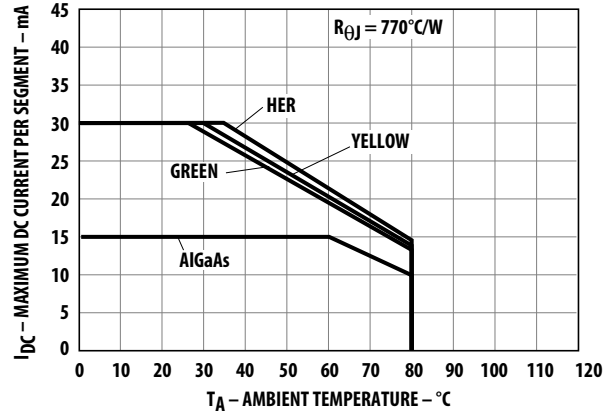

Figure 4. Maximum allowable DC current vs. ambient temperature.

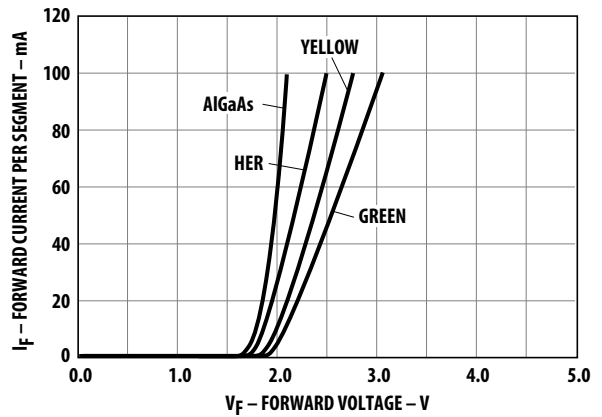

Figure 5. Forward current vs. forward voltage.

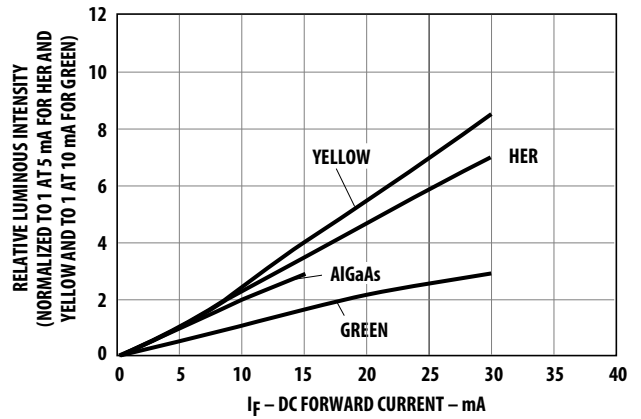

Figure 6. Relative luminous intensity vs. DC forward current.

Contrast Enhancement

For information on contrast enhancement, please see Application Note 1015.

Soldering/Cleaning

Cleaning agents from the ketone family (acetone, methyl ethyl ketone, etc.) and from the chlorinated hydrocarbon family (methylene chloride, trichloroethylene, carbon tetrachloride, etc.) are not recommended for cleaning LED parts. All of these various solvents attack or dissolve the encapsulating epoxies used to form the package of plastic LED parts.

For information on soldering LEDs, please refer to Application Note 1027.

For product information and a complete list of distributors, please go to our website: www.avagotech.com

Avago, Avago Technologies, and the A logo are trademarks of Avago Technologies in the United States and other countries.
Data subject to change. Copyright © 2005-2014 Avago Technologies. All rights reserved. Obsoletes 5989-2834EN
AV02-0625EN - June 23, 2014

