

# NCV890231GEVB

## NCV890231 Automotive Grade High-Frequency Buck Regulator Evaluation Board User's Manual



ON Semiconductor®

<http://onsemi.com>

### EVAL BOARD USER'S MANUAL

#### Description

The NCV890231 evaluation board provides a convenient way to evaluate a high-frequency buck converter design. No additional components are required, other than dc supplies for the input and enable voltages. An external clock can be used to synchronize the switching frequency; and the board also provides a synchronization output, enabling it to be used as a master. It is configured for a 3.3 V output with a 2 MHz switching frequency and a 2.0 A maximum output current, over the typical 4.5 V to 18 V automotive input voltage range. In addition, the board regulates up to 30 V thanks to switching frequency foldback.

#### Key Features

- 3.3 V Output Voltage
- 2 MHz Switching Frequency
- 2.0 A Current Limit
- Wide Input Voltage of 4.5 V to 45 V
- Regulates through Load Dump Conditions
- External Clock Synchronization up to 2.5 MHz
- Synchronization Output
- Automotive Grade

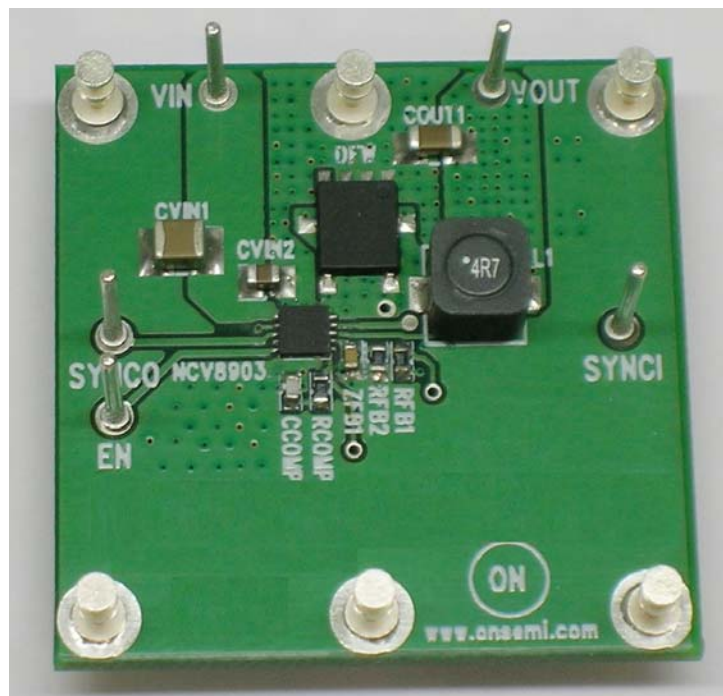

Figure 1. NCV890231GEVB Board Picture

# NCV890231GEVB

**Table 1. DEMONSTRATION BOARD TERMINALS**

Terminal	Function
VIN	Positive dc input voltage
GND	Common dc return
VOUT	Regulated dc output voltage
EN	Enable input
SYNCl	Input for external clock synchronization
SYNCO	Output for synchronizing other boards

**Table 2. ABSOLUTE MAXIMUM RATINGS**

(Voltages are with respect to GND)

Rating	Value	Units
Dc supply voltage (VIN, EN)	-0.3 to 45 V	V
Dc supply voltage (SYNCl)	-0.3 to 6 V	V
Junction Temperature (NCV890231)	-40 to 150	°C
Ambient temperature (Demo Board)	-40 to 85	°C

Stresses exceeding Maximum Ratings may damage the device. Maximum Ratings are stress ratings only. Functional operation above the Recommended Operating Conditions is not implied. Extended exposure to stresses above the Recommended Operating Conditions may affect device reliability.

**Table 3. ELECTRICAL CHARACTERISTICS**

( $T_A = 25^\circ\text{C}$ ,  $4.5\text{ V} \leq V_{IN} \leq 40\text{ V}$ ,  $V_{EN} = 2\text{ V}$ ,  $V_{OUT} = 3.3\text{ V}$ ,  $0 \leq I_{OUT} \leq 2.0\text{ A}$ , unless otherwise specified)

Characteristics	Conditions	Typical Value	Units
<b>Regulation</b>			
Output Voltage		3.30	V
Voltage Accuracy		4	%
Line Regulation	$I_{OUT} = 1.0\text{ A}$	0.12	%
Load Regulation	$V_{IN} = 13.2\text{ V}$	0.03	%
<b>Switching</b>			
Switching Frequency		2.0	MHz
Soft-start Time		1.4	ms
SYNCl Frequency range		1.8 to 2.5	MHz
<b>Current Limit</b>			
Average Current Limit	$V_{IN} = 6\text{ to }18\text{ V}$	1.8	A
Cycle-by-cycle Current Limit		2.45	A
<b>Protections</b>			
Input Undervoltage Lockout (UVLO)	$V_{IN}$ decreasing	4.2	V
Thermal Shutdown	$T_A$ increasing	170	°C

## NCV890231GEVB

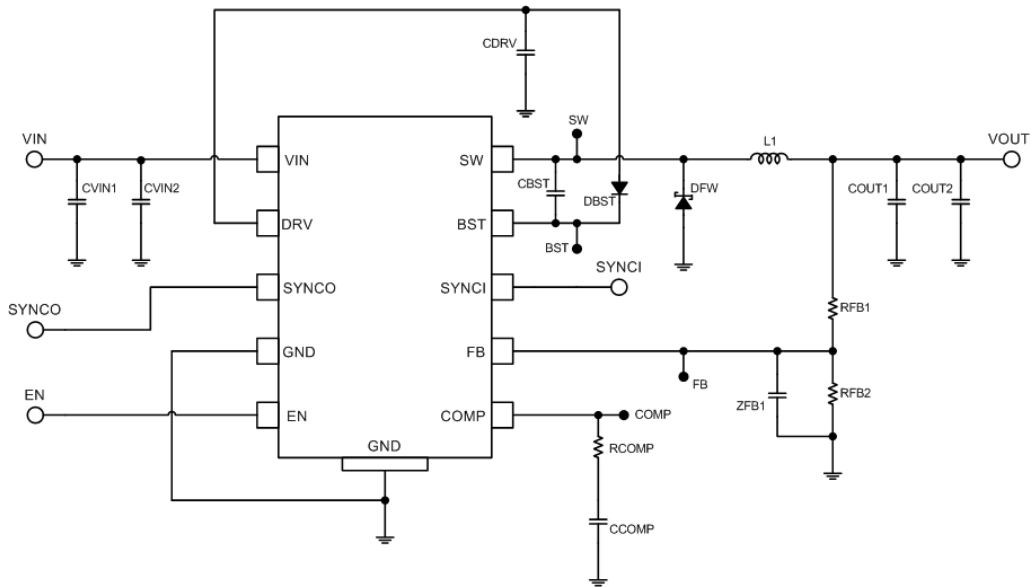

**Figure 2. NCV890231GEVB Board Schematic**

### Operational Guidelines

1. Connect a dc input voltage, within the 4.5 V to 45 V range, between VIN and GND
2. Connect a load between VOUT and GND
3. Connect a dc enable voltage, within the 4.5 V to 40 V range, between EN and GND
4. Optionally, for external clock synchronization, connect a pulse source between SYNCI and GND. The high state level should be within the 2 to 6 V range, and the low state level within the -0.3 V to 0.8 V range, with a minimum pulse width of 40 ns and a frequency within the 1.8 to 2.5 MHz range.

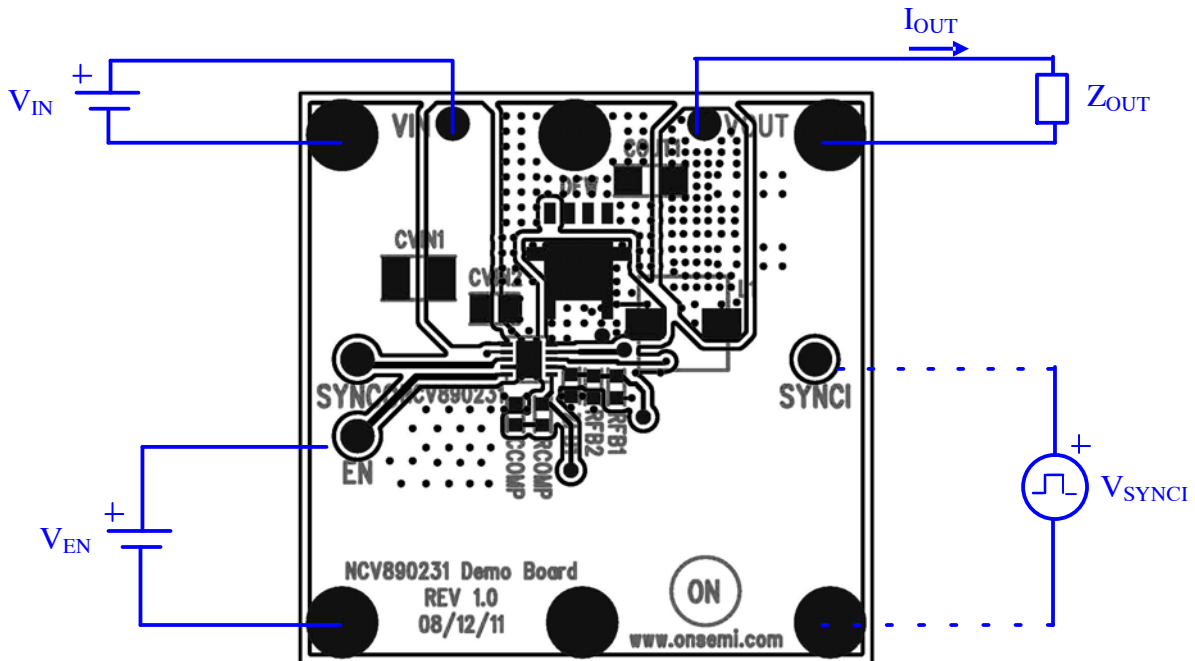

**Figure 3. NCV890231GEVB Board Connections**

TYPICAL PERFORMANCE

Efficiency

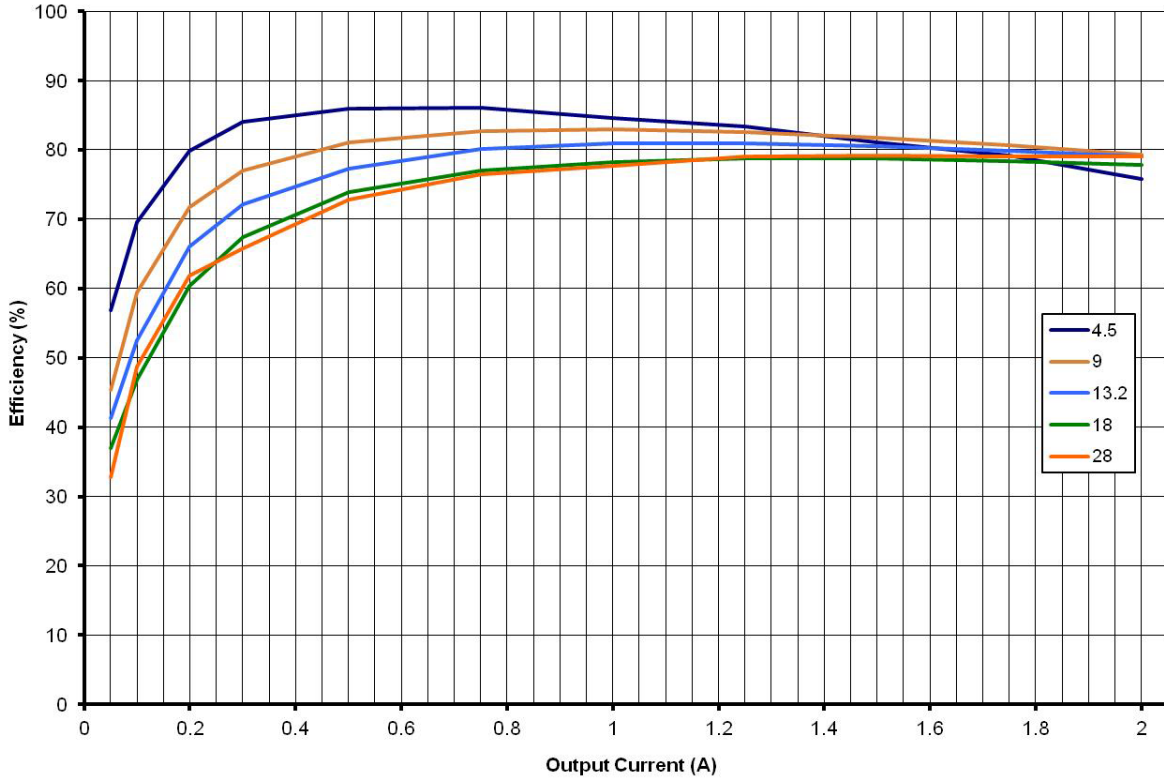

Figure 4. Efficiency at 2 MHz for a 3.3 V output

Start-up

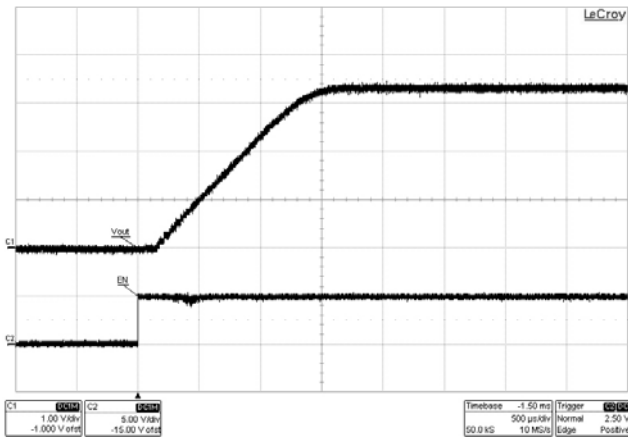

Figure 5. Typical start-up with  $V_{IN} = 13.2\text{ V}$ ,  $V_{OUT} = 3.3\text{ V}$  and  $I_{OUT} = 0.2\text{ A}$

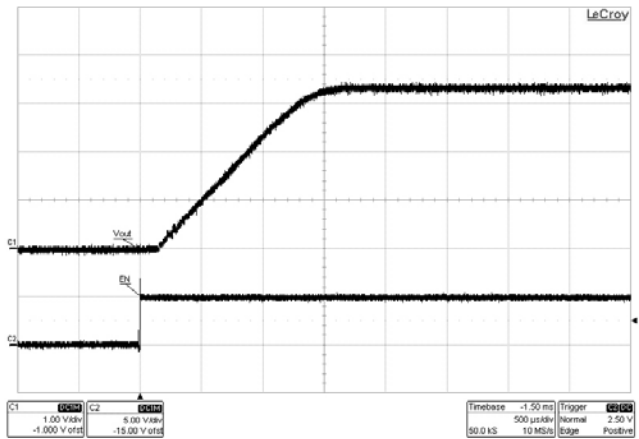

Figure 6. Typical start-up with  $V_{IN} = 13.2\text{ V}$ ,  $V_{OUT} = 3.3\text{ V}$  and  $I_{OUT} = 1.8\text{ A}$

Load Transients

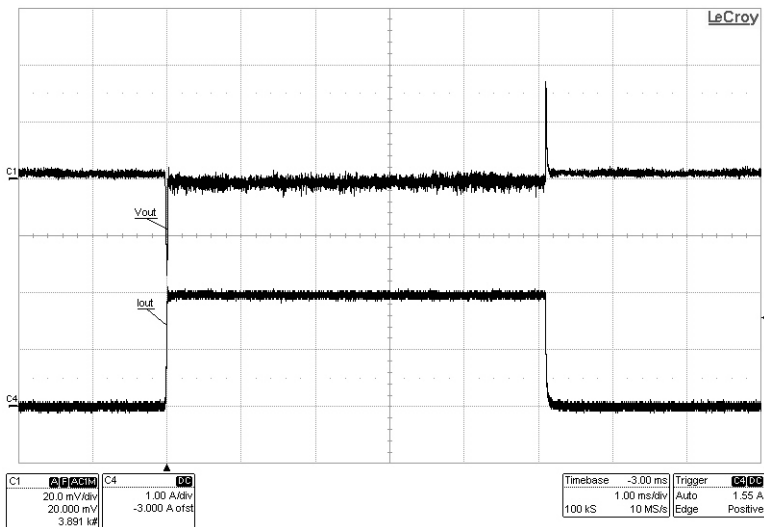

Figure 7. Load transient 0.1 A to 2.0 A, with  $V_{OUT} = 3.3\text{ V}$  and  $V_{IN} = 13.2\text{ V}$

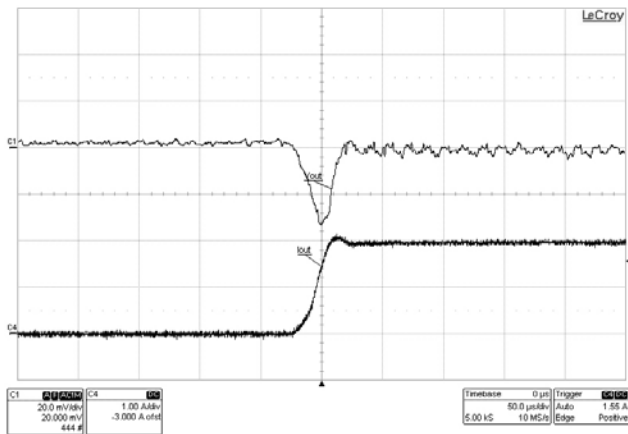

Figure 8. Load transient 0.2 A to 2.0 A, with  $V_{OUT} = 3.3\text{ V}$  and  $V_{IN} = 13.2\text{ V}$

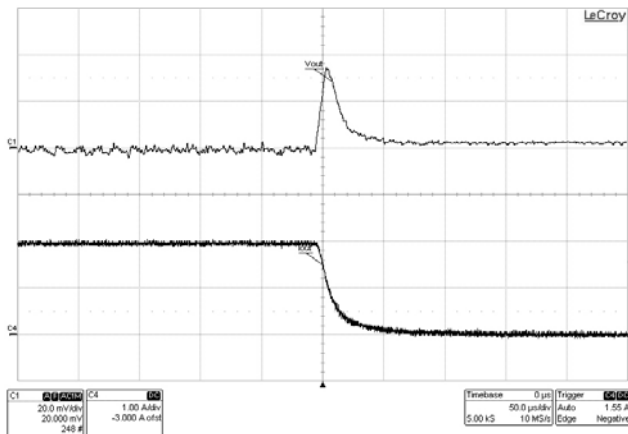

Figure 9. Load transient 2.0 A to 0.2 A, with  $V_{OUT} = 3.3\text{ V}$  and  $V_{IN} = 13.2\text{ V}$

# NCV890231GEVB

## Synchronization

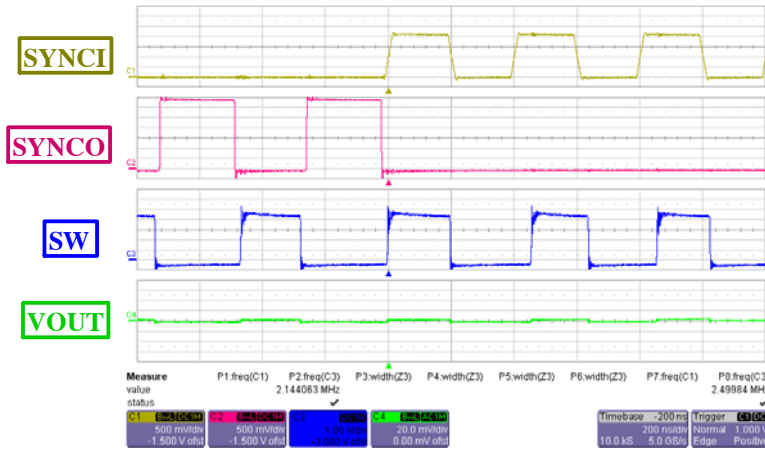

Figure 10. Starting synchronization at 2.5 MHz (from free-running)

## Minimum on time

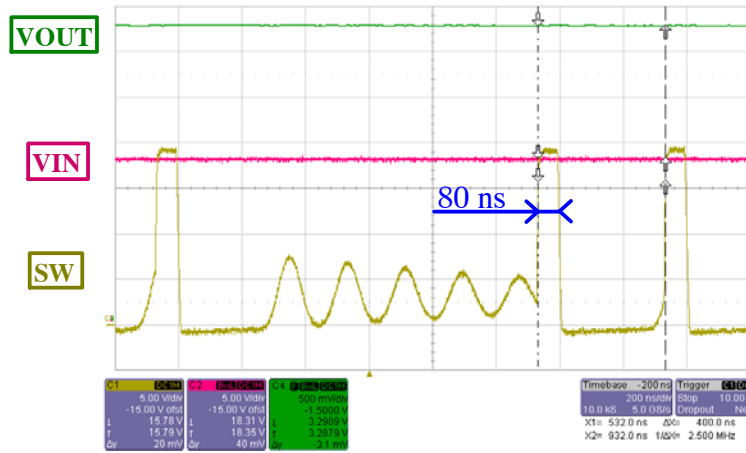
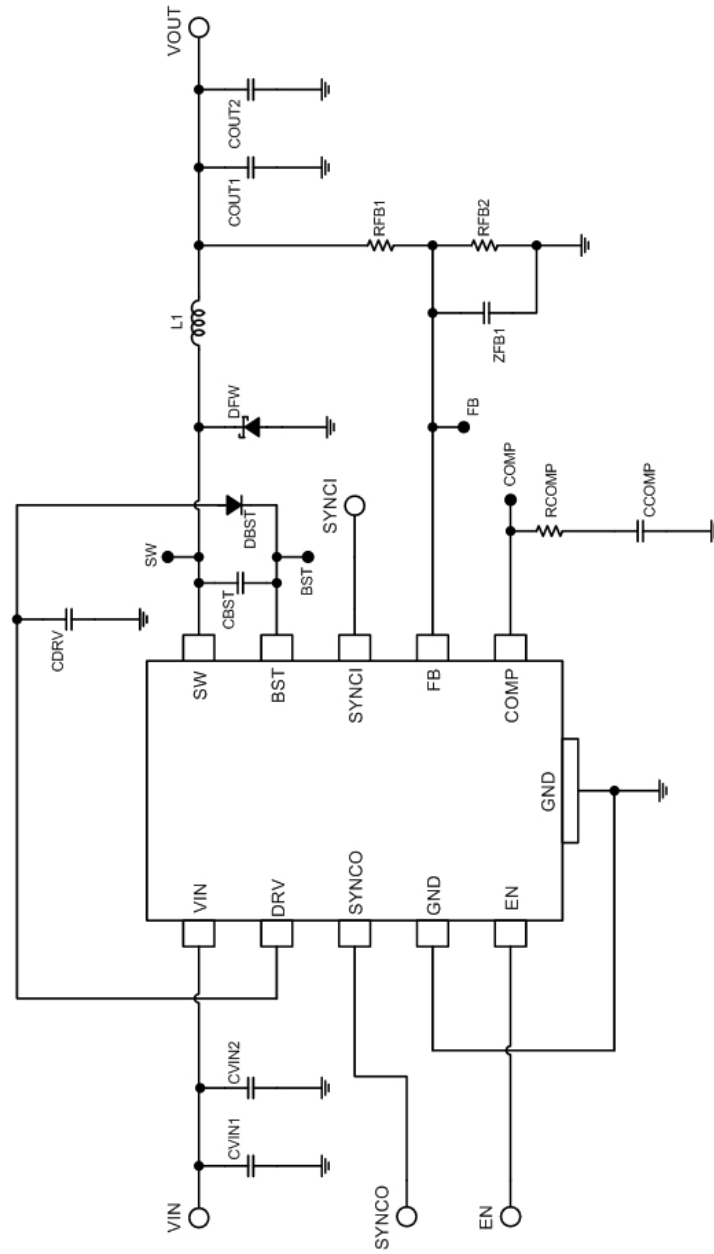

Figure 11. Minimum on time seen during a load transient

# NCV890231GEVB

## Schematic



# NCV890231GEVB

## PCB LAYOUT

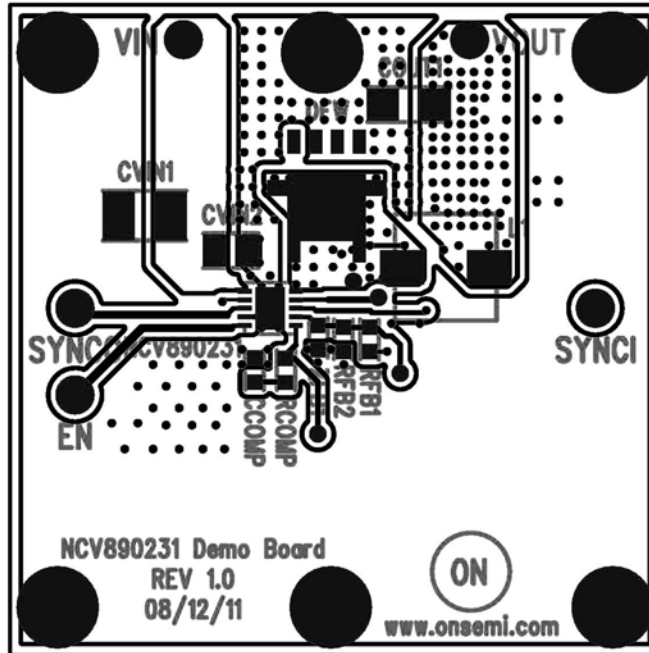

Figure 12. Top View

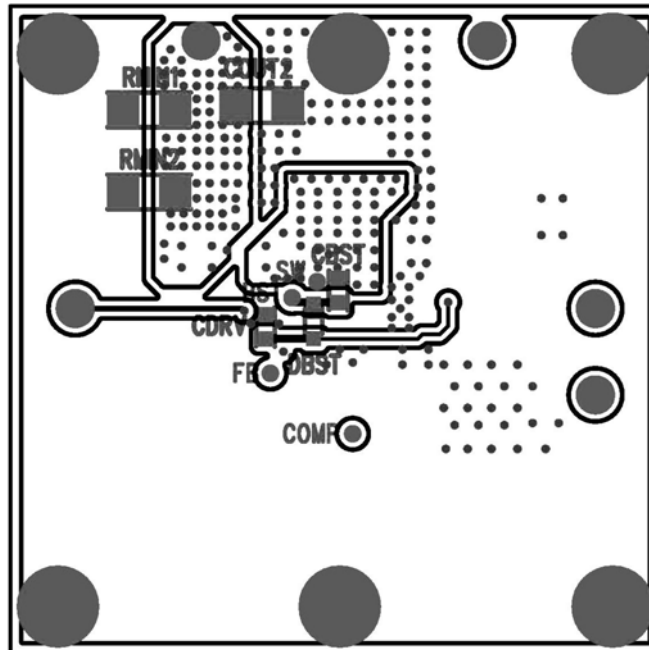



Figure 13. Bottom View



# NCV890231GEVB

**Table 4. BILL OF MATERIALS**

Reference	Value	Part #	Manufacturer	Description	Package
U1		NCV890231	ON Semiconductor	Integrated circuit	3x3 DFN10
L1	4.7 $\mu$ H	7447786004	Wurth	Inductor	WE-PD-XS
DFW		MBR440MFS	ON Semiconductor	Diode, Schottky, 1.5A, 40V	SMB
DBST		BAS16HT1	ON Semiconductor	Diode, Switching, 200mA, 75V	SOD-323
CVIN1	4.7 $\mu$ F		Murata	Capacitor, Ceramic, 50V, X7R	1210
CVIN2	1 $\mu$ F		Murata	Capacitor, Ceramic, 50V, X5R	0805
CDRV, CBST	0.1 $\mu$ F		Kemet	Capacitor, Ceramic, 10V, X7R	0603
ZFB1	4.7 nF		Murata	Capacitor, Ceramic, 50V, X7R	0603
COUT1, COUT2	10 $\mu$ F		Murata	Capacitor, Ceramic, 10V, X7R	1206
CCOMP	330 pF		Murata	Capacitor, Ceramic, 50V, C0G	0603
RCOMP	12.4 K $\Omega$		Vishay	Resistor, 1%	0603
RFB1	100 $\Omega$		Vishay	Resistor, 1%	0603
RFB2	31.6 $\Omega$		Vishay	Resistor, 1%	0603

**ON Semiconductor** and  are registered trademarks of Semiconductor Components Industries, LLC (SCILLC). SCILLC owns the rights to a number of patents, trademarks, copyrights, trade secrets, and other intellectual property. A listing of SCILLC's product/patent coverage may be accessed at [www.onsemi.com/site/pdf/Patent-Marking.pdf](http://www.onsemi.com/site/pdf/Patent-Marking.pdf). SCILLC reserves the right to make changes without further notice to any products herein. SCILLC makes no warranty, representation or guarantee regarding the suitability of its products for any particular purpose, nor does SCILLC assume any liability arising out of the application or use of any product or circuit, and specifically disclaims any and all liability, including without limitation special, consequential or incidental damages. "Typical" parameters which may be provided in SCILLC data sheets and/or specifications can and do vary in different applications and actual performance may vary over time. All operating parameters, including "Typicals" must be validated for each customer application by customer's technical experts. SCILLC does not convey any license under its patent rights nor the rights of others. SCILLC products are not designed, intended, or authorized for use as components in systems intended for surgical implant into the body, or other applications intended to support or sustain life, or for any other application in which the failure of the SCILLC product could create a situation where personal injury or death may occur. Should Buyer purchase or use SCILLC products for any such unintended or unauthorized application, Buyer shall indemnify and hold SCILLC and its officers, employees, subsidiaries, affiliates, and distributors harmless against all claims, costs, damages, and expenses, and reasonable attorney fees arising out of, directly or indirectly, any claim of personal injury or death associated with such unintended or unauthorized use, even if such claim alleges that SCILLC was negligent regarding the design or manufacture of the part. SCILLC is an Equal Opportunity/Affirmative Action Employer. This literature is subject to all applicable copyright laws and is not for resale in any manner.

## PUBLICATION ORDERING INFORMATION

### LITERATURE FULFILLMENT:

Literature Distribution Center for ON Semiconductor  
P.O. Box 5163, Denver, Colorado 80217 USA  
**Phone:** 303-675-2175 or 800-344-3860 Toll Free USA/Canada  
**Fax:** 303-675-2176 or 800-344-3867 Toll Free USA/Canada  
**Email:** [orderlit@onsemi.com](mailto:orderlit@onsemi.com)

**N. American Technical Support:** 800-282-9855 Toll Free  
USA/Canada  
**Europe, Middle East and Africa Technical Support:**  
Phone: 421 33 790 2910  
**Japan Customer Focus Center**  
Phone: 81-3-5817-1050

**ON Semiconductor Website:** [www.onsemi.com](http://www.onsemi.com)

**Order Literature:** <http://www.onsemi.com/orderlit>

For additional information, please contact your local Sales Representative