

# LOW JITTER PIN CONFIGURABLE DUAL LVPECL OUTPUT ULTRA MINIATURE PURE SILICON™ CLOCK OSCILLATOR

ASEMDLP

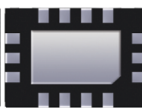

3.2 x 2.5 x 0.85 mm

**ASEMDLP**



RoHS/RoHS II compliant

## Moisture Sensitivity Level – MSL 1

### FEATURES:

- Ultra Miniature Pure Silicon™ Clock Oscillator
- Pin Configurable LVPECL Dual output
- Low Jitter (Period Jitter RMS 3ps typical)
- Low Integrated Phase Jitter 2ps max
- Excellent Shock & Vibration Immunity

### APPLICATIONS:

- Consumer Electronics
- Storage Area Networks
- SATA, SAS, Fibre Channel
- Passive Optical Networks
- EPON, 10G-EPON, GPON, 10G-PON
- Ethernet
- 1G, 10GBASE-T/KR/LR/SR, and FCoE
- PCI Express

Low Jitter  
Pin Configurable  
LVPECL Dual Output  
3G MEMS

### STANDARD SPECIFICATIONS:

#### Pre-programmed Output Frequency Configuration

| Ordering Info             | Freq (MHz)        | Freq Select Bits [FS2, FS1, FS0] – Default is [111] |     |     |        |        |        |     |            |
|---------------------------|-------------------|---|-----|-----|--------|--------|--------|-----|------------|
|                           |                   | 000   | 001 | 010 | 011    | 100    | 101    | 110 | <b>111</b> |
| Frequency Configuration 1 | f <sub>OUT1</sub> | 106.25  | 100 | 125 | 156.25 | 156.25 | 156.25 | 125 | <b>400</b> |
|                           | f <sub>OUT2</sub> | 25  | 100 | 125 | 156.25 | 25     | 125    | 25  | <b>200</b> |
| Custom Configuration      | f <sub>OUT1</sub> | Contact Abracon for customized configurations       |     |     |        |        |        |     |            |
|                           | f <sub>OUT2</sub> |   |     |     |        |        |        |     |            |

Frequency select bits [FS2, FS1, FS0] are weakly tied high so if left **floated**, the default setting will be [111] and the device will output the associated frequency highlighted in **Bold**. If other frequency combinations are required, please contact Abracon for customized configuration. Please see the configurable frequency range in the section 2.0

#### Key Electrical Specifications

| Parameters                           | Minimum  | Typical               | Maximum               | Units | Notes                             |              |
|--------------------------------------|--|-----------------------|-----------------------|-------|-----------------------------------|--------------|
| Configurable frequency range         | 10   | ----                  | 460                   | MHz   | Commercial, Industrial temp range |              |
| Operating Temperature                | -20  | ----                  | +70                   | °C    | See options                       |              |
| Storage Temperature                  | -55  | ----                  | +150                  | °C    |                                   |              |
| Overall Frequency Stability*1        | -50  | ----                  | +50                   | ppm   | See options                       |              |
| Supply Voltage (V <sub>dd</sub> )    | +2.25  | ----                  | +3.6                  | V     |                                   |              |
| Startup Time                         | ----   | ----                  | 5                     | ms    |                                   |              |
| Enable Time                          | ----   | ----                  | 20                    | ns    |                                   |              |
| Disable Time                         | ----   | ----                  | 5                     | ns    |                                   |              |
| Disable Current                      | ----   | 21                    | 23                    | mA    |                                   |              |
| Tri-state Function (Standby/Disable) | "1" (VIH≥0.75*V <sub>dd</sub> ) or Open: Oscillation<br>"0" (VIL<0.25*V <sub>dd</sub> ) : Hi Z |                       |                       | V     | 40kΩ pull-up resistor embedded    |              |
| Aging                                | -5.0   | ----                  | +5.0                  | ppm   | First year                        |              |
| Supply Current (I <sub>dd</sub> )    | ----   | 89                    | ----                  | mA    | RL=50Ω, 156.25MHz                 |              |
| Output Logic Level                   | V <sub>OH</sub>  | V <sub>dd</sub> -1.08 | ----                  | V     | RL=50 Ω                           |              |
|                                      | V <sub>OL</sub>  | ----                  | V <sub>dd</sub> -1.55 |       |                                   |              |
| Peak to Peak Output Swing            | ----   | 800                   | ----                  | mV    | Single-Ended                      |              |
| Rise Time                            | T <sub>r</sub>   | ----                  | 250                   | ps    | RL=50 Ω, CL=2pF                   |              |
| Fall Time                            | T <sub>f</sub>   | ----                  | 250                   | ps    | 20% to 80%                        |              |
| Duty Cycle                           |  | 48                    | ----                  | 52    | %                                 | Differential |

\*1. Frequency stability includes frequency variations due to initial tolerance, temp. and power supply voltage

ABRACON IS  
ISO9001:2008  
CERTIFIED



**ABRACON**  
CORPORATION

Visit [www.abracon.com](http://www.abracon.com) for Terms & Conditions of Sale **Revised: 11.05.14**  
30332 Esperanza, Rancho Santa Margarita, California 92688  
tel 949-546-8000 | fax 949-546-8001 | [www.abracon.com](http://www.abracon.com)

# LOW JITTER PIN CONFIGURABLE DUAL LVPECL OUTPUT ULTRA MINIATURE PURE SILICON™ CLOCK OSCILLATOR

ASEMDLP

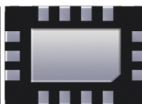

3.2 x 2.5 x 0.85 mm

ASEMDLP



RoHS/RoHS II compliant

## Key Electrical Specifications (continued)

| Parameters                           | Minimum | Typical | Maximum | Units | Notes                        |
|--------------------------------------|---------|---------|---------|-------|------------------------------|
| Period Jitter RMS ( $J_{PER}$ )      | -----   | 2.5     | -----   | ps    | F01=F02= 156.25MHz           |
| Integrated Phase Jitter ( $J_{PH}$ ) | -----   | 0.25    | 2       | ps    | 200kHz ~ 20MHz,<br>156.25MHz |
|                                      | -----   | 0.38    | 2       |       | 100kHz ~ 20MHz,<br>156.25MHz |
|                                      | -----   | 1.70    | 2       |       | 12kHz ~ 20MHz,<br>156.25MHz  |

## PHASE JITTER

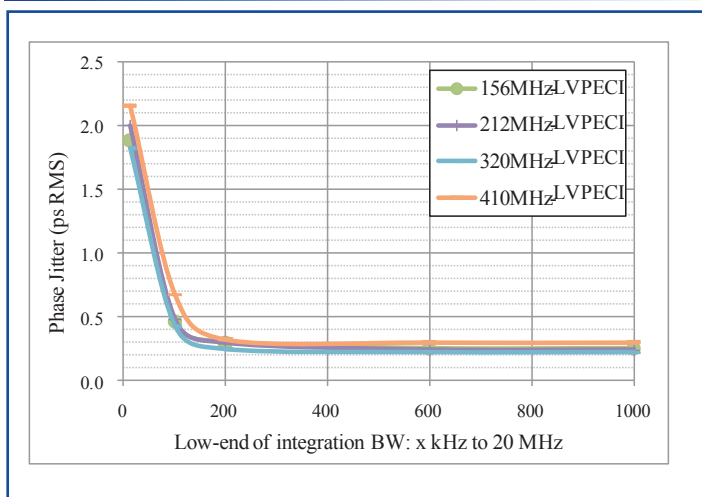

## ABSOLUTE MAXIMUM RATINGS

| Item            | Minimum | Maximum      | Unit | Condition |
|-----------------|---------|--------------|------|-----------|
| Supply Voltage  | -0.3    | +4.0         | V    |           |
| Input Voltage   | -0.3    | $V_{dd}+0.3$ | V    |           |
| Junction Temp.  | -----   | +150         | °C   |           |
| Storage Temp.   | -55     | +150         | °C   |           |
| Soldering Temp. | -----   | +260         | °C   | 40sec max |
| ESD             |         |              | V    |           |
| HBM             |         | 4,000        |      |           |
| MM              |         | 400          |      |           |
| CDM             |         | 1,500        |      |           |

## OPTIONS AND PART IDENTIFICATION:

(left blank if standard)

ASEMDLP -  -  -

| Operating Temp.      |
|----------------------|
| Blank: -20°C ~ +70°C |
| L: -40°C ~ +85°C     |

| Overall Freq. Stability |
|-------------------------|
| Blank: ±50ppm           |
| R: ±25 ppm              |

| Packaging                      |
|--------------------------------|
| Blank: Tube (110pcs / Tube)    |
| T: Tape & Reel (1kpcs / reel)  |
| T3: Tape & Reel (3kpcs / reel) |
| T5: Tape & Reel (5kpcs / reel) |

| Frequency Combination  | Freq (MHz) | Freq Select Bits [FS2, FS1, FS0] – Default is [111] |     |     |        |        |        |     |     |
|------------------------|------------|---|-----|-----|--------|--------|--------|-----|-----|
|                        |            | 000   | 001 | 010 | 011    | 100    | 101    | 110 | 111 |
| Standard Configuration | $f_{OUT1}$ | 106.25  | 100 | 125 | 156.25 | 156.25 | 156.25 | 125 | 400 |
|                        | $f_{OUT2}$ | 25  | 100 | 125 | 156.25 | 25     | 125    | 25  | 200 |
| Custom Configuration   | $f_{OUT1}$ | Contact Abracon for customized configurations       |     |     |        |        |        |     |     |
|                        | $f_{OUT2}$ |   |     |     |        |        |        |     |     |

Default condition: Frequency select bits [FS2, FS1, FS0] are all left floated. FS2, FS1, FS0 are pulled high [111]  
Frequency combination and default frequency is customized upon request. Please contact Abracon for the frequency combinations.

ABRACON IS  
ISO9001:2008  
CERTIFIED



Visit [www.abracon.com](http://www.abracon.com) for Terms & Conditions of Sale **Revised: 11.05.14**  
30332 Esperanza, Rancho Santa Margarita, California 92688  
tel 949-546-8000 | fax 949-546-8001 | [www.abracon.com](http://www.abracon.com)

# LOW JITTER PIN CONFIGURABLE DUAL LVPECL OUTPUT ULTRA MINIATURE PURE SILICON™ CLOCK OSCILLATOR

ASEMDLP

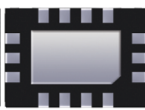

3.2 x 2.5 x 0.85 mm

ASEMDLP



RoHS/RoHS II compliant

## MECHANICAL DIMENSIONS

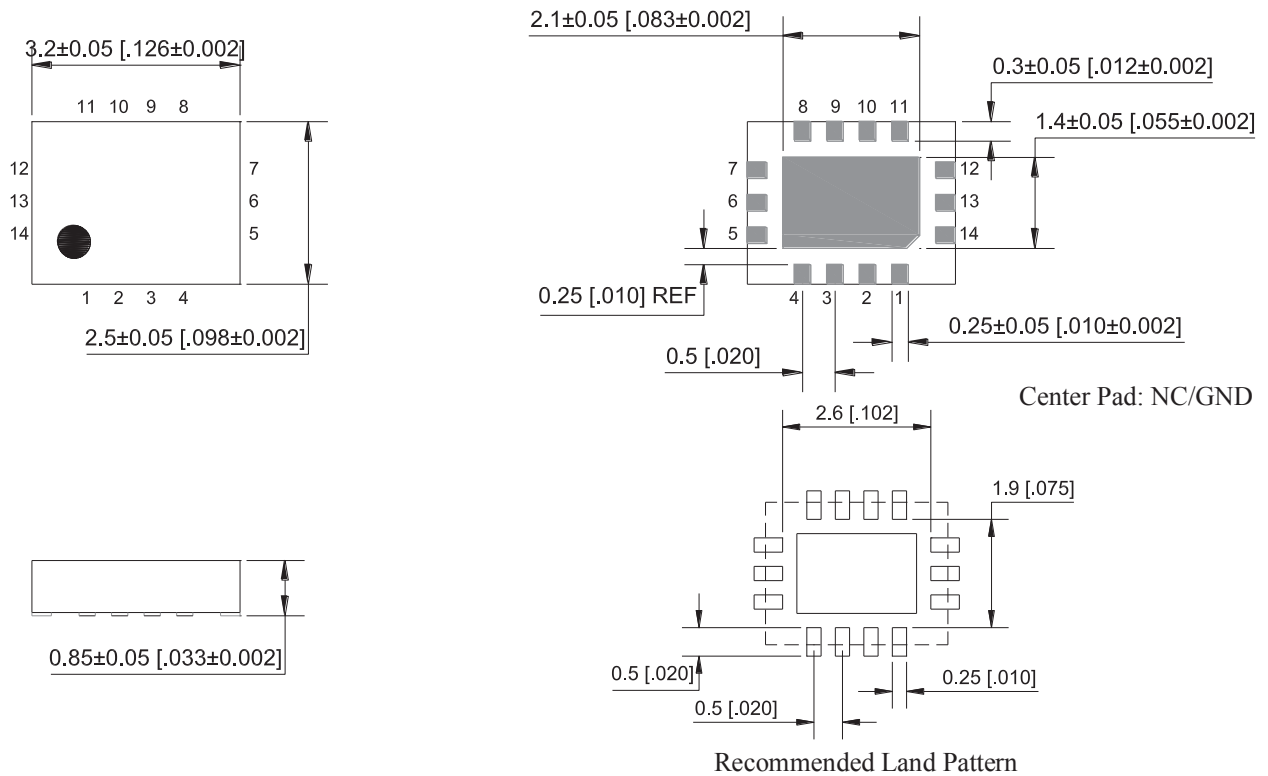

| Pin No. | Pin Name  | Pin Type | Description  |
|---------|-----------|----------|--|
| 1       | Enable    | I        | Enables outputs when high and disables (tri-state) them when low |
| 2       | NC        | NA       | Leave unconnected or grounded                                    |
| 3       | NC        | NA       | Leave unconnected or grounded                                    |
| 4       | GND       | Power    | Ground   |
| 5       | FS0       | I        | Least significant bit for frequency selection                    |
| 6       | FS1       | I        | Middle bit for frequency selection                               |
| 7       | FS2       | I        | Most significant bit for frequency selection                     |
| 8       | Output1+  | O        | Positive LVPECL Output 1   |
| 9       | Output1-  | O        | Negative LVPECL Output 1   |
| 10      | Output 2- | O        | Negative LVPECL Output 2   |
| 11      | Output 2+ | O        | Positive LVPECL Output 2   |
| 12      | VDD2      | Power    | Power Supply 2 for LVPECL Output 2                               |
| 13      | VDD       | Power    | Power Supply   |
| 14      | NC        | NA       | Leave unconnected or grounded                                    |

Dimensions: mm (inches)

# LOW JITTER PIN CONFIGURABLE DUAL LVPECL OUTPUT ULTRA MINIATURE PURE SILICON™ CLOCK OSCILLATOR

ASEMDLP

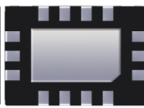

3.2 x 2.5 x 0.85 mm

ASEMDLP



RoHS/RoHS II compliant

## REFLOW PROFILE

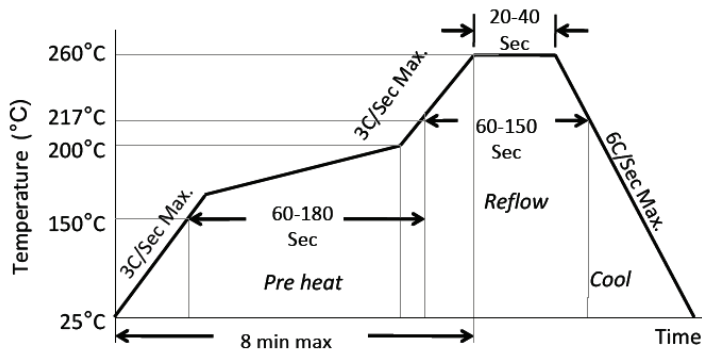

|                                   |              |
|-----------------------------------|--------------|
| Ramp-Up Rate (200°C to Peak Temp) | 3°C/Sec Max. |
| Preheat Time 150°C to 200°C       | 60-180 Sec   |
| Time maintained above 217°C       | 60-150 Sec   |
| Peak Temperature                  | 255-260°C    |
| Time within 5°C of actual Peak    | 20-40 Sec    |
| Ramp-Down Rate                    | 6°C/Sec Max. |
| Time 25°C to Peak Temperature     | 8 min Max.   |

## TAPE & REEL:

T= 1,000pcs/reel (D=180mm)  
T3= 3,000pcs/reel (D=180mm)  
T5= 5,000pcs/reel (D=330mm)

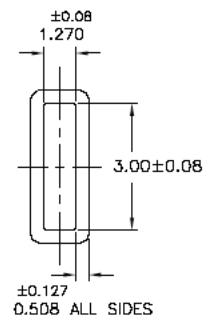
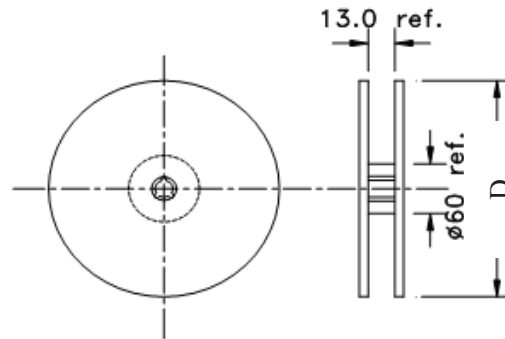
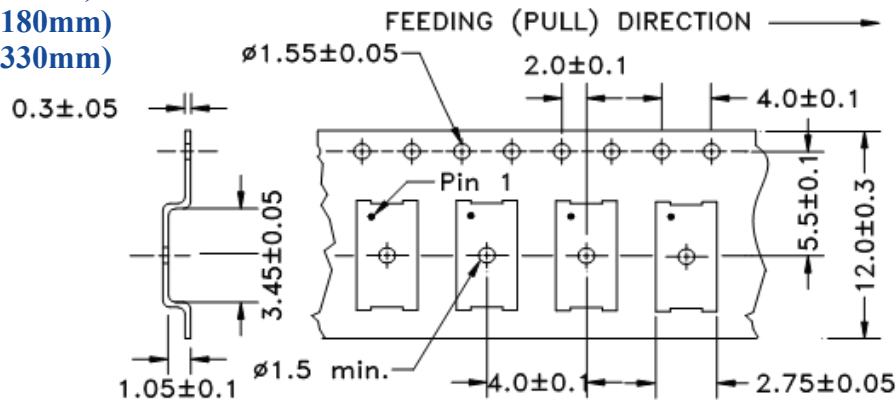

Tube: 110 pcs/tube

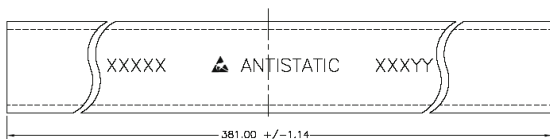

Unit orientation in tube:



Dimensions: mm

**ATTENTION:** Abracon Corporation's products are COTS – Commercial-Off-The-Shelf products; suitable for Commercial, Industrial and, where designated, Automotive Applications. Abracon's products are not specifically designed for Military, Aviation, Aerospace, Life-dependant Medical applications or any application requiring high reliability where component failure could result in loss of life and/or property. For applications requiring high reliability and/or presenting an extreme operating environment, written consent and authorization from Abracon Corporation is required. Please contact Abracon Corporation for more information.

ABRACON IS  
ISO9001:2008  
CERTIFIED



**ABRACON  
CORPORATION**

Visit [www.abracon.com](http://www.abracon.com) for Terms & Conditions of Sale **Revised: 11.05.14**  
30332 Esperanza, Rancho Santa Margarita, California 92688  
tel 949-546-8000 | fax 949-546-8001 | [www.abracon.com](http://www.abracon.com)