

SERPAC 023i (exploded isometric)

Electronic Enclosures

- Click on image to show toolbar. Use ▶ || to Play/Pause Animation.
- Left click and drag on image to move 3D model.

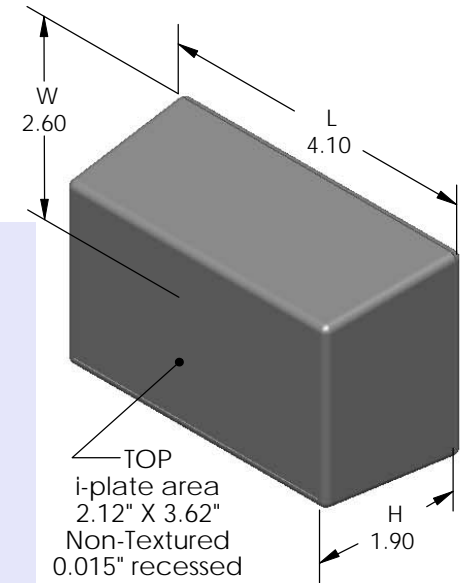
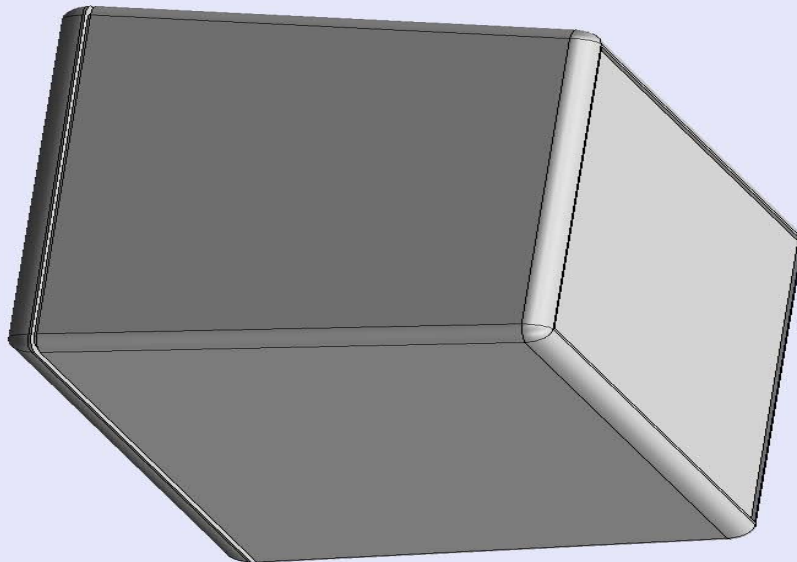

- a) Zoom in & out with center wheel.
- b) Pause at any moment to view and or print views.
- c) Change the views to ortho and section views if needed from the Views pull down menu.
- d) Explore options included in the tool bar like: Views, Transparency of model, Lighting type, etc.

PART NO.	DESCRIPTION (Included)	ACCESSORIES (Optional)	
2-3-i	TOP	PART NO.	DESCRIPTION
02	BOTTOM	52	Non-skid feet
6005	#4X3/8" Self tapping (2)		

Notes: (Enclosure weight 0.16 lb / 74 gm)
 1) Enclosure meets or exceeds IP40 and NEMA 1
 2) Circuit Board drawings can be download at:
http://www.serpac.com/Products/Accessories/CircuitBoard/drawings/CB_02X.pdf
 3) All components are RoHS Compliant.

ALL DIMENSIONS ARE ±.010" 3/17/10 (1 of 2)
619 Commercial Ave. Covina, CA 91723
 Ph. (626) 331-0517 Fx. (626) 331-8584 serpac.com

SERPAC 023i (user print)

Electronic Enclosures

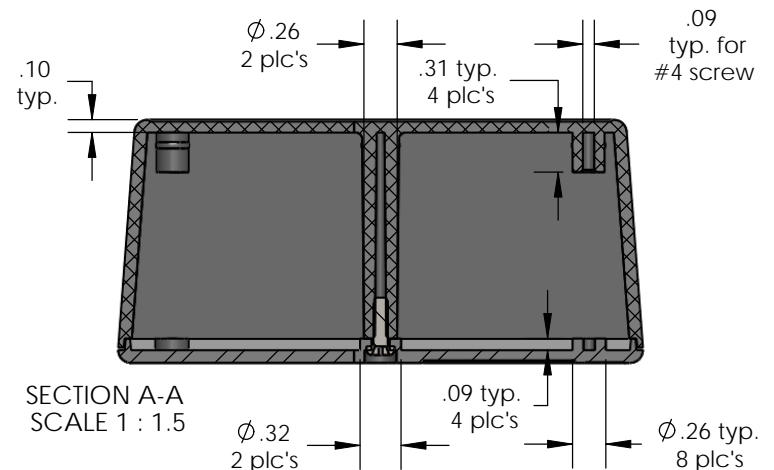
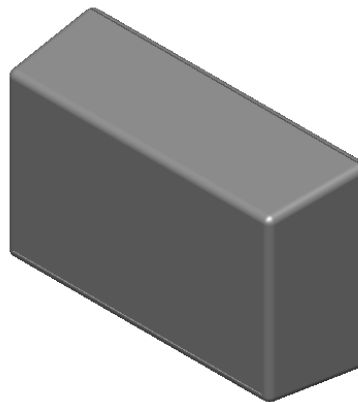
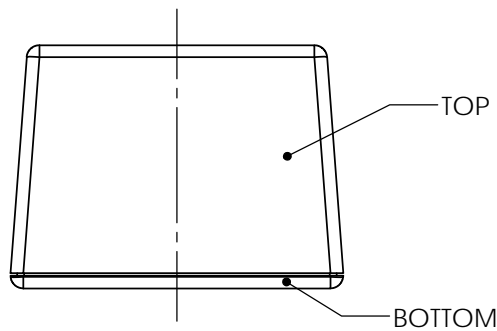
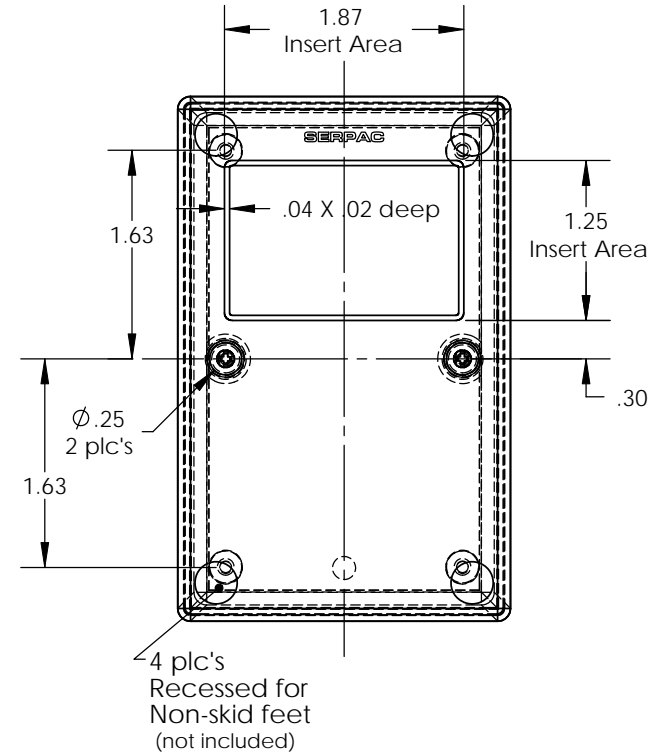
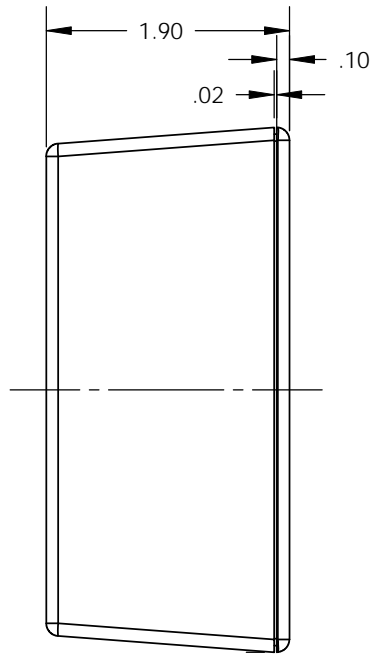
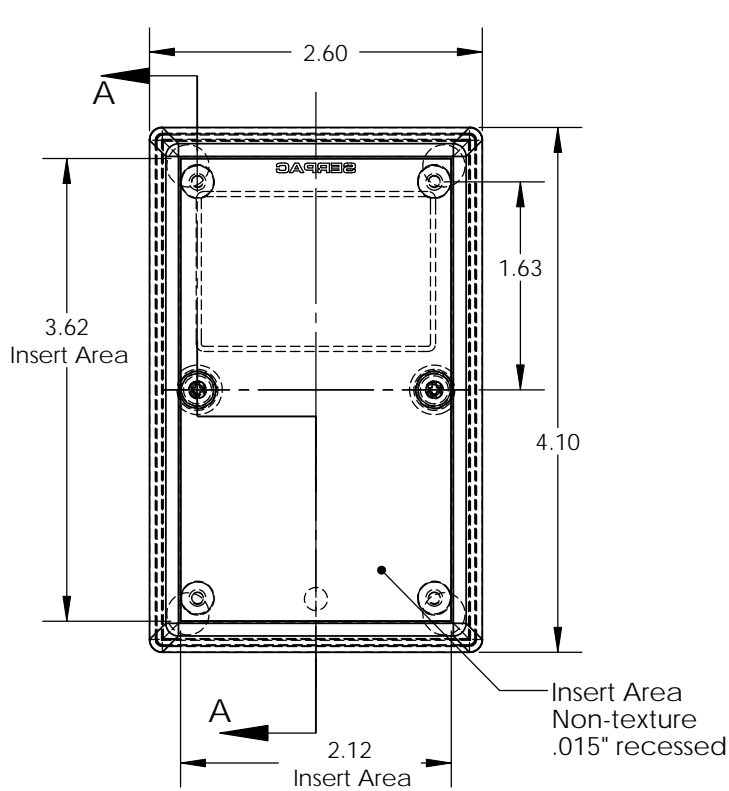

PART NO.	DESCRIPTION (Included)	ACCESSORIES (Optional)	
2-3-i	TOP	PART NO.	DESCRIPTION
02	BOTTOM	52	Non-skid feet
6005	#4X3/8" self tapping (2)		

Notes: (Enclosure weight 0.16 lb / 74 gm)
 1) Enclosure meets or exceeds IP40 and NEMA 1
 2) Circuit Board drawings can be download at:
http://www.serpac.com/Products/Accessories/CircuitBoard/drawings/CB_02X.pdf
 3) All components are RoHS Compliant.

ALL DIMENSIONS ARE ± .010" 3/17/10 (2 of 2)
619 Commercial Ave. Covina, CA 91723
 Ph. (626) 331-0517 Fx. (626) 331-8584 www.serpac.com