

DIGITAL CONTROLLED STEREO AUDIO PROCESSOR WITH LOUDNESS

1 FEATURES

- INPUT MULTIPLEXER:
3 STEREO INPUTS
- RECORD OUTPUT FUNCTION
- LOUDNESS FUNCTION
- VOLUME CONTROL IN 1dB STEPS
- INDEPENDENT LEFT AND RIGHT VOLUME CONTROL
- SOFT MUTE FUNCTION
- ALL FUNCTIONS PROGRAMMABLE VIA SERIAL I²C BUS

Figure 1. Packages



Table 1. Order Codes

Part Number	Package
TDA7309	DIP20
TDA7309D	SO20
TDA7309D013TR	Tape & Reel

2 DESCRIPTION

The TDA7309 is a control processor with independent left and right volume control for quality audio applications. Selectable external loudness and soft mute functions are provided.

Control is accomplished by serial I²C bus micro-processor interface.

The AC signal setting is obtained by resistor networks and switches combined with operational amplifiers.

Thanks to the used BIPOLAR/CMOS Technology, Low Distortion, Low Noise and Low DC stepping are obtained.

Figure 2. Block Diagram

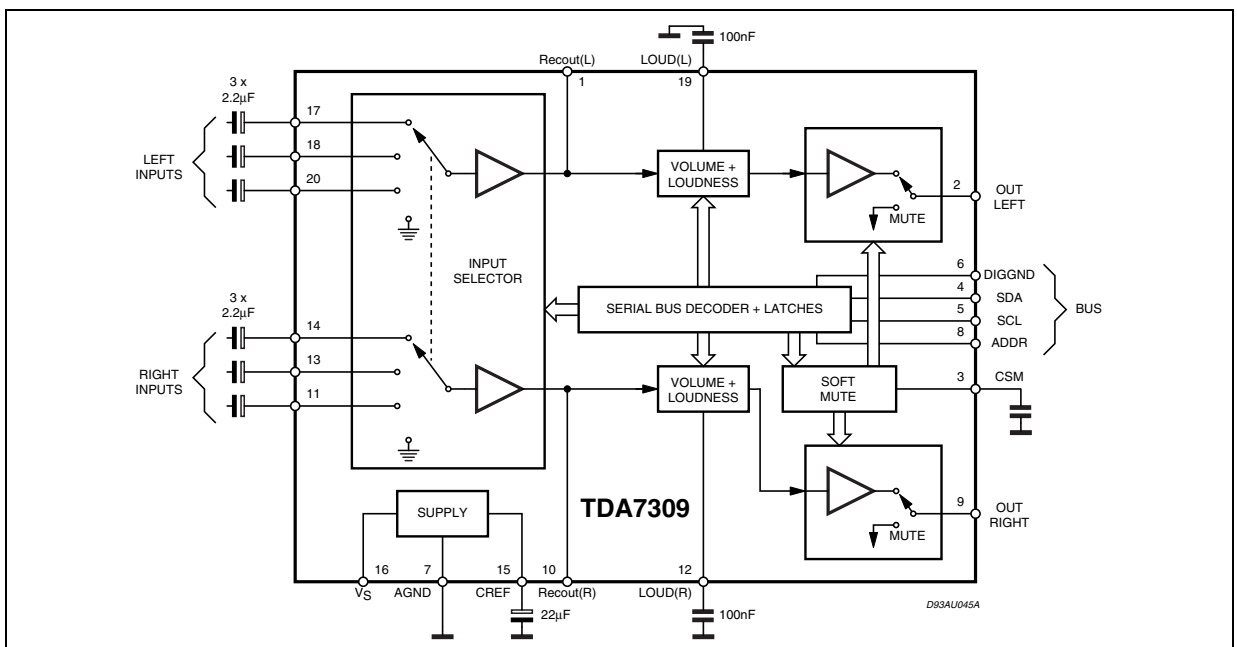

Figure 3. Pin Description

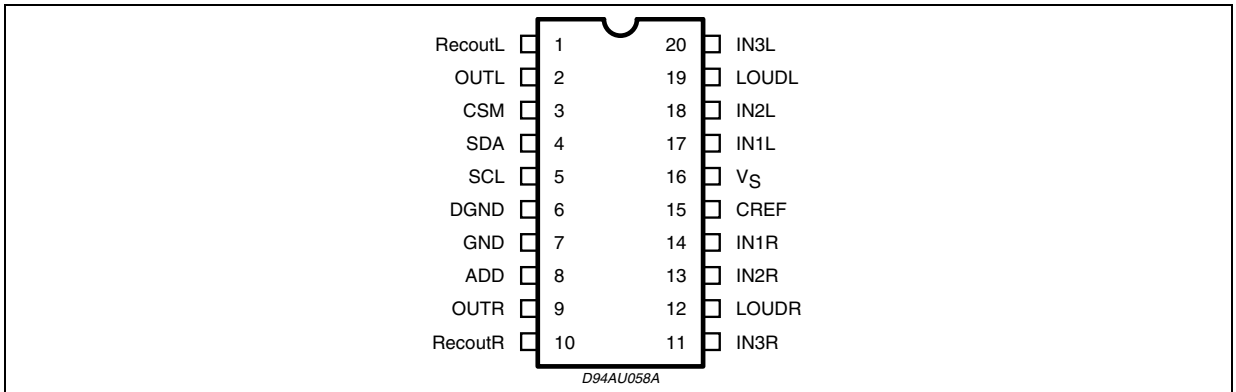

Table 2. Absolute Maximum Ratings

Symbol	Parameter	Value	Unit
V _S	Operating Supply Voltage	10.5	V
T _{amb}	Operating Ambient Temperature	-40 to 85	°C
T _{stg}	Storage Temperature Range	-55 to +150	°C

Table 3. QUICK REFERENCE DATA

Symbol	Parameter	Test Condition	Min.	Typ.	Max.	Unit
V _S	Operating Supply Voltage		6		10	V
V _{CL}	Max. Input Signal Handling		2			V _{rms}
THD	Total Harmonic Distortion	V = 1V _{rms} , f = 1KHz		0.01	0.1	%
S/N	Signal to Noise Ratio			106		dB
Sc	Channel Separation f = 1KHz			100		dB
	Volume Control 1.0dB step		-95		0	dB
	Soft Mute Attenuation			60		dB
	Direct Mute Attenuation			100		dB

Table 4. Thermal Data

Symbol	Parameter	SO20	DIP20	Unit
R _{th j-pins}	Thermal resistance Junction to Pins	150	100	°C/W

Figure 4. Test Circuit

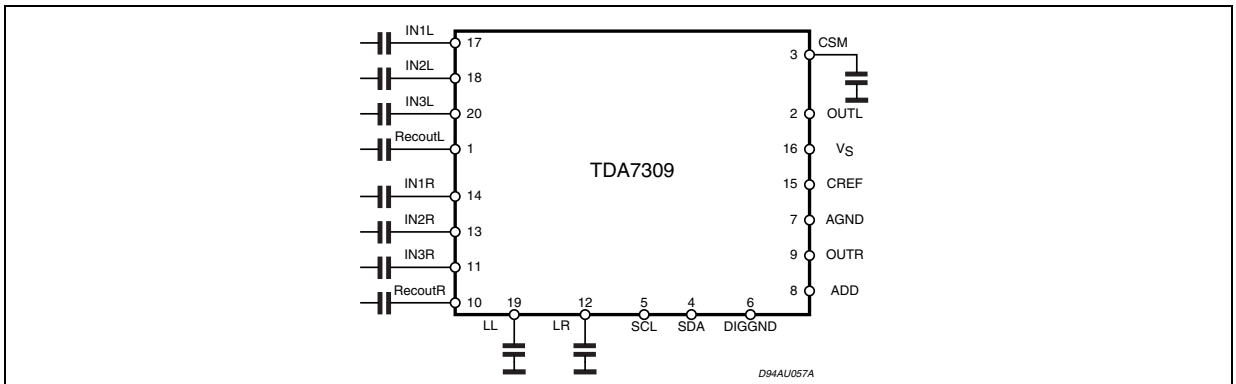

Table 5. Electrical Characteristics (Refer to the test circuit, $T_{amb} = 25^{\circ}\text{C}$, $V_S = 9\text{V}$, $R_L = 10\text{K}\Omega$, $R_G = 50\Omega$, all controls flat ($G = 0$), $f = 1\text{KHz}$ unless otherwise specified.)

Symbol	Parameter	Test Condition	Min.	Typ.	Max.	Unit
SUPPLY						
V_S	Supply Voltage		5 (*)	9	10	V
I_S	Supply Current			7	10	mA
SVR	Ripple Rejection		60	85		dB
INPUT SELECTORS						
R_I	Input Resistance		35	50	65	$\text{K}\Omega$
S_{in}	Input Separation		80	90		dB
VOLUME CONTROL						
C_{RANGE}	Control Range			92		dB
A_{VMAX}	Max. Attenuation		87	92	95	dB
A_{STEP}	Step resolution		0.5	1	1.5	dB
E_A	Attenuation Set Error	$A_V = 0$ to -24dB	-1.2		1.2	dB
		$A_V = -24$ to -56dB	-3		2	dB
E_T	Tracking Error				2	dB
V_{DC}	DC Steps	adjacent attenuation steps		0	3	mV
		from 0dB to $A_{V\max}$		0.5	5	mV
A_{mute}	Output Mute Attenuation		80	100		dB
SOFT MUTE						
T_d	Delay Time	$C_{smute} = 22\text{nF}$; 0 to -20dB				
		Fast Mode		1		ms
		Slow Mode		20		ms
AUDIO OUTPUTS						
V_{CLIP}	Clipping Level	$d = 0.3\%$	2	2.6		V_{rms}
R_L	Output Load Resistance		2			$\text{K}\Omega$
R_{out}	Output Impedance		100	200	300	Ω
V_{DC}	DC Voltage Level			3.8		V
GENERAL						
e_{NO}	Output Noise	BW = 20-20KHz, flat; output muted		2.5		μV
		all gains = 0dB		5	15	μV
		A curve all gains = 0dB		3		μV
E_t	Total Tracking Error	$A_V = 0$ to -24dB		0	1	dB
		$A_V = -24$ to -56dB		0	2	dB
S/N	Signal to Noise Ratio	all gains = 0dB ; $V_O = 1V_{rms}$	95	106		dB
d	Distortion			0.01	0.1	%
S_C	Channel Separation		80	100		dB
BUS INPUTS						
V_{IL}	Input Low Voltage				1	V
V_{IH}	Input High Voltage		3			V
I_{IN}	Input Current	$V_{in} = 0.4\text{V}$	-5		+5	μA
V_O	Output Voltage SDA Acknowledge	$I_O = 1.6\text{mA}$		0.4	0.8	V

(*) Hedevice work until 5V but no guarantee about SVR

Figure 5. Noise vs. Volume Setting.

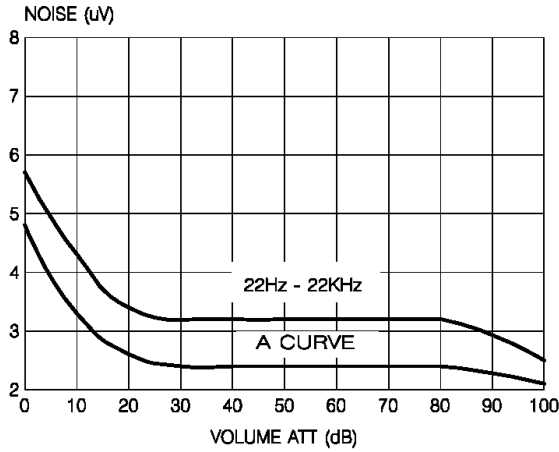

Figure 8. THD vs. R_{LOAD}.

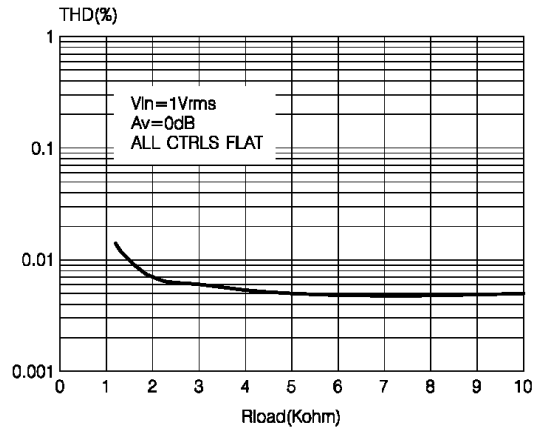

Figure 6. SVRR vs. Frequency.

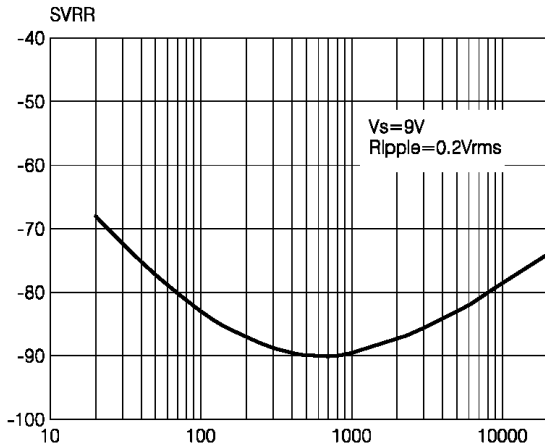

Figure 9. Channel Separation vs. Frequency.

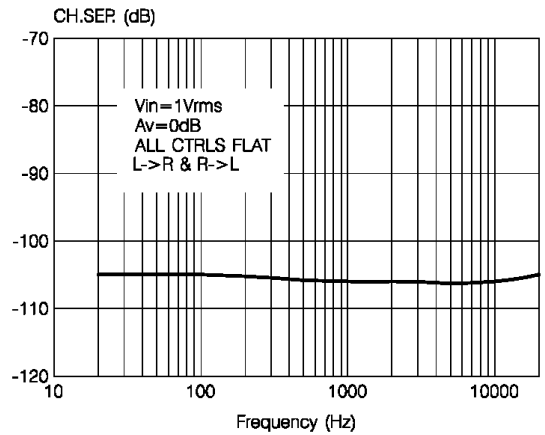

Figure 7. THD vs. frequency

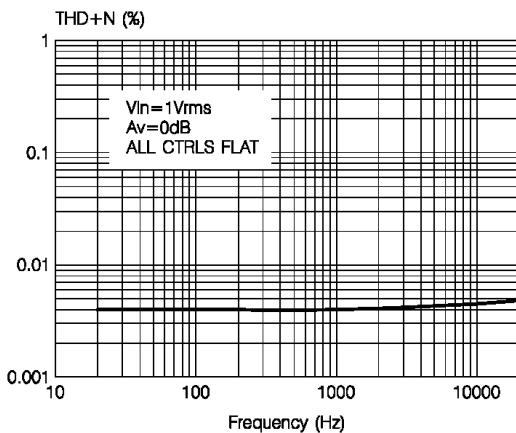

Figure 10. Output Clip Level vs. Supply Voltage.

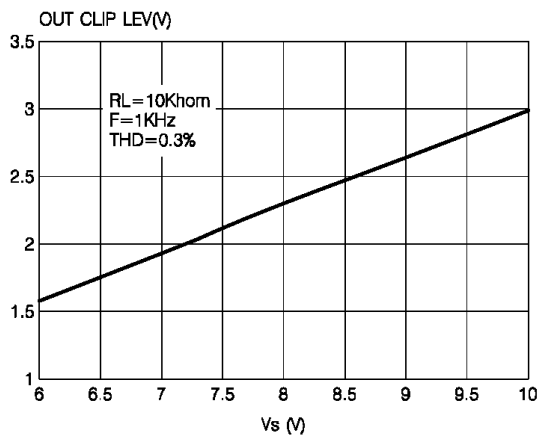

Figure 11. Quiescent Current vs. Supply Voltage

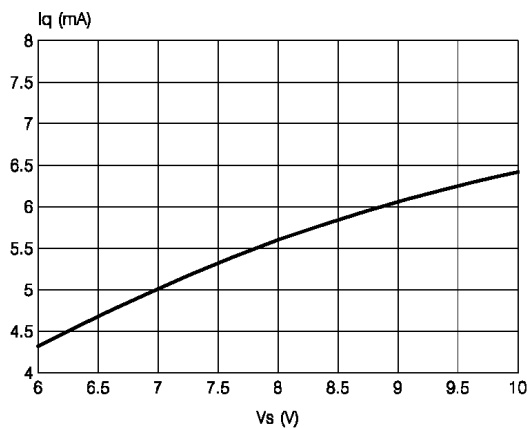

Figure 13. Loudness vs. Frequency (C_{LOAD} = 100nF) vs. Volume

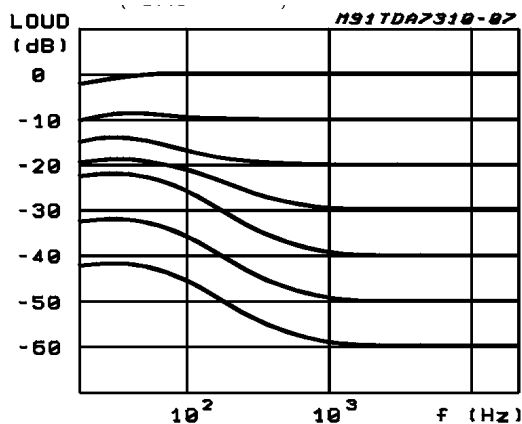

Figure 12. Loudness vs. Volume Attenuation

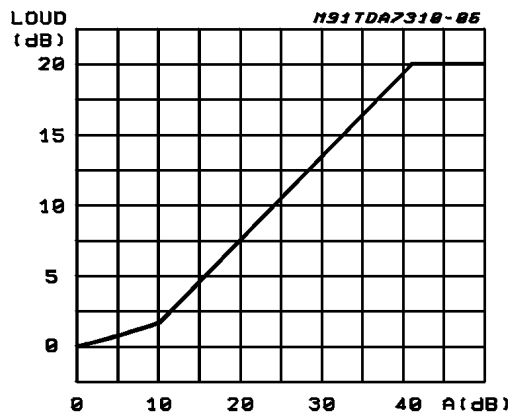
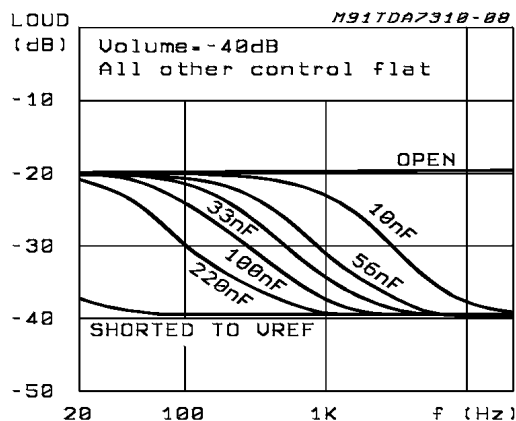

Figure 14. Loudness vs. External Capacitors



3 I²C BUS INTERFACE

Data transmission from microprocessor to the TDA7313 and viceversa takes place thru the 2 wires I²C BUS interface, consisting of the two lines SDA and SCL (pull-up resistors to positive supply voltage must be connected).

3.1 Data Validity

As shown in fig. 11, the data on the SDA line must be stable during the high period of the clock. The HIGH and LOW state of the data line can only change when the clock signal on the SCL line is LOW.

3.2 Start and Stop Conditions

As shown in fig. 16 a start condition is a HIGH to LOW transition of the SDA line while SCL is HIGH. The stop condition is a LOW to HIGH transition of the SDA line while SCL is HIGH.

3.3 Byte Format

Every byte transferred on the SDA line must contain 8 bits. Each byte must be followed by an acknowledge bit. The MSB is transferred first.

3.4 Acknowledge

The master (μ P) puts a resistive HIGH level on the SDA line during the acknowledge clock pulse (see fig. 17). The peripheral (audioprocessor) that acknowledges has to pull-down (LOW) the SDA line during the acknowledge clock pulse, so that the SDA line is stable LOW during this clock pulse.

The audioprocessor which has been addressed has to generate an acknowledge after the reception of each byte, otherwise the SDA line remains at the HIGH level during the ninth clock pulse time. In this case the master transmitter can generate the STOP information in order to abort the transfer.

3.5 Transmission without Acknowledge

Avoiding to detect the acknowledge of the audioprocessor, the μ P can use a simpler transmission: simply it waits one clock without checking the slave acknowledging, and sends the new data. This approach of course is less protected from misworking and decreases the noise immunity.

Figure 15. Data Validity on the I²CBUS

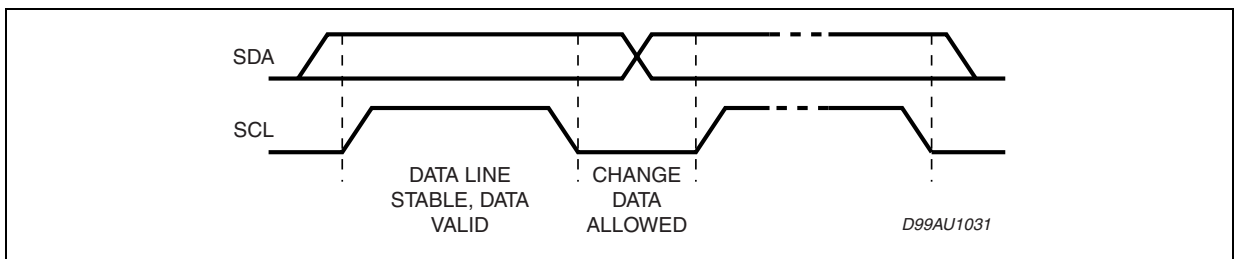

Figure 16. Timing Diagram of I²CBUS

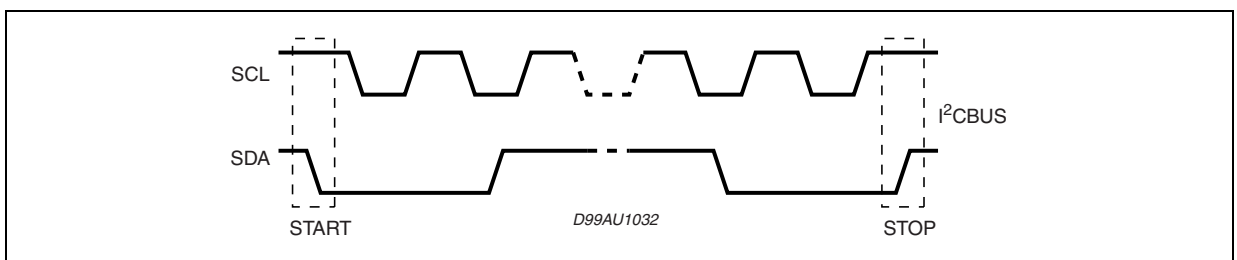

Figure 17. Acknowledge on the I²CBUS

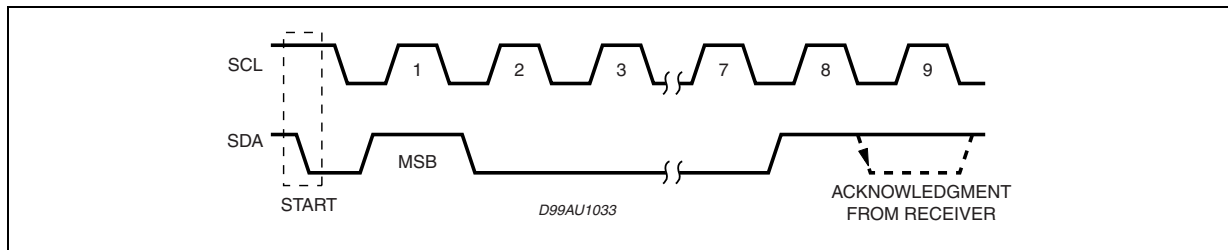
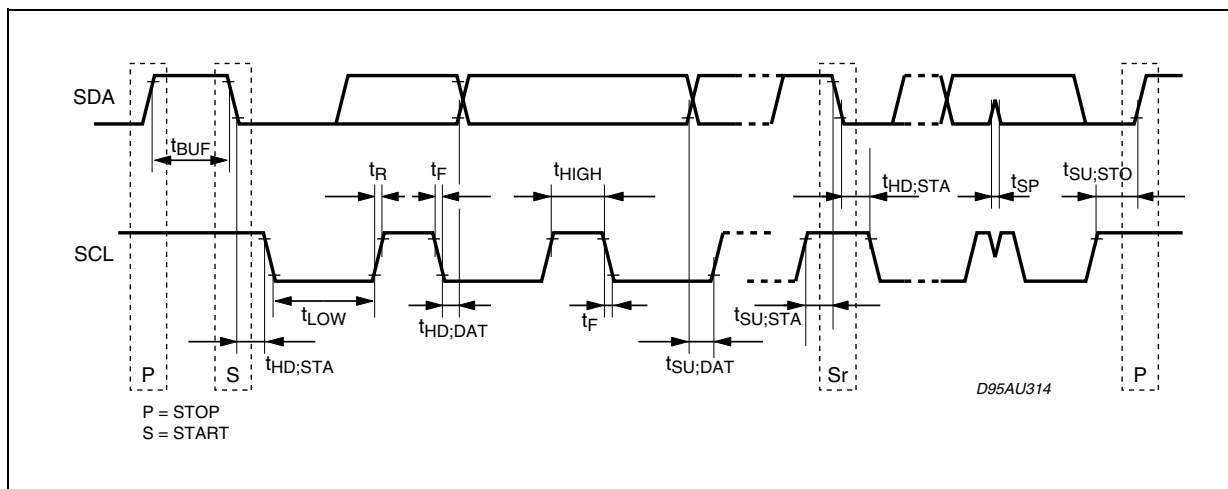

Table 6. SDA, SCL I²CBUS Timing

Symbol	Parameter	Min.	Typ.	Max.	Unit
f _{SCL}	SCL clock frequency	0		400	kHz
t _{BUF}	Bus free time between a STOP and START condition	1.3			μs
t _{HD:STA}	Hold time (repeated) START condition. After this period, the first clock pulse is generated	0.6			μs
t _{LOW}	LOW period of the SCL clock	1.3			μs
t _{HIGH}	HIGH period of the SCL clock	0.6			μs
t _{SU:STA}	Set-up time for a repeated START condition	0.6			μs
t _{HD:DA}	Data hold time	0.300			μs
t _{SU:DAT}	Data set-up time	100			ns
t _R	Rise time of both SDA and SCL signals	20		300	ns (*)
t _F	Fall time of both SDA and SCL signals	20		300	ns (*)
t _{SU:STO}	Set-up time for STOP condition	0.6			μs

All values referred to VIH min. and VIL max. levels
 (*) Must be guaranteed by the I²C BUS master.

Figure 18. Definition of Timing on the I²C-bus



4 SOFTWARE SPECIFICATION

4.1 Interface Protocol

The interface protocol comprises:

- A start condition (S)
- A chip address byte, containing the TDA7309 address (the 8th bit of the byte must be 0).
The TDA7309 must always acknowledge at the end of each transmitted byte.
- A sequence of data (N-bytes + acknowledge)
- A stop condition (P)

Figure 19.

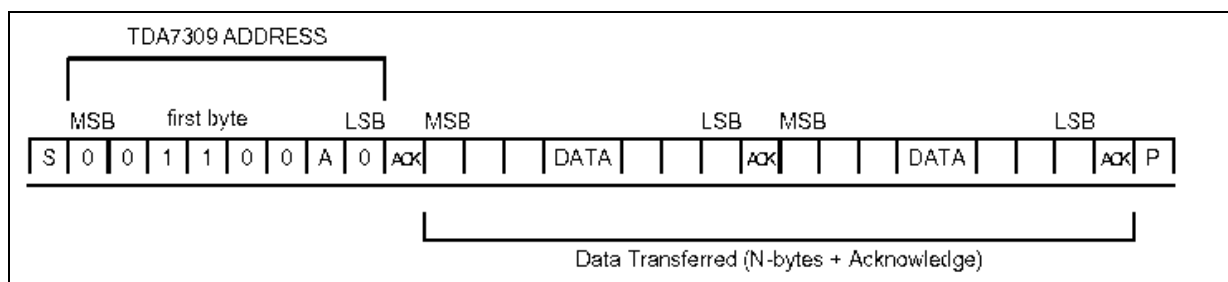

ACK = Acknowledge

S = Start

P = Stop

MAX CLOCK SPEED 400kbits/s

Table 7. Chip address

MSB				LSB				
0	0	1	1	0	0	1	0	pin address open
0	0	1	1	0	0	0	0	pin address close to ground

Table 8. Function Codes

	MSB	F6	F5	F4	F3	F2	F1	LSB
VOLUME	0	X	X	X	X	X	X	X
MUTE/LOUD	1	0	0	X	X	X	X	X
INPUTS	1	0	1	X	X	X	X	X
CHANNEL	1	1	0	X	X	X	X	X

Table 9. Channel Abilitation Codec

MSB	F6	F5	F4	F3	F2	F1	LSB	FUNCTION
1	1	0						channel
			X	X	X	0	0	RIGHT
			X	X	X	0	1	LEFT
			X	X	X	1	0	BOTH
			X	X	X	1	1	BOTH

4.2 Power on reset condition

11111110

Table 10. Volume Codes

MSB	F6	F5	F4	F3	F2	F1	LSB	FUNCTION
0								step 1dB
					0	0	0	0dB
					0	0	1	-1dB
					0	1	0	-2dB
					0	1	1	-3dB
					1	0	0	-4dB
					1	0	1	-5dB
					1	1	0	-6dB
					1	1	1	-7dB
0								step 8dB
	0	0	0	0				0dB
	0	0	0	1				-8dB
	0	0	1	0				-16dB
	0	0	1	1				-24dB
	0	1	0	0				-32dB
	0	1	0	1				-40dB
	0	1	1	0				-48dB
	0	1	1	1				-56dB
	1	0	0	0				-64dB
	1	0	0	1				-72dB
	1	0	1	0				-80dB
	1	0	1	1				-88dB
	1	1	X	X				MUTE

Table 11. Mute Loudness Codes

MSB	F6	F5	F4	F3	F2	F1	LSB	FUNCTION
1	0	0						mute/loud
			X			0	0	slow soft mute on
			X			0	1	fast soft mute on
						1		soft mute off
					1			LOUD OFF
			X	0	0			loud on (10dB)
			X	1	0			loud on (20dB)

Table 12. Input Multiplexer Codes

MSB	F6	F5	F4	F3	F2	F1	LSB	FUNCTION
1	0	1						inputs
			X	X	X	0	0	MUTE
			X	X	X	0	1	IN2
			X	X	X	1	0	IN3
			X	X	X	1	1	IN1

Purchase of I²C Components of STMicroelectronics, conveys a license under the Philips I²C Patent Rights to use these components in an I²C system, provided that the system conforms to the I²C Standard Specifications as defined by Philips.

Figure 20. DIP20 Mechanical Data & Package Dimensions

DIM.	mm			inch		
	MIN.	TYP.	MAX.	MIN.	TYP.	MAX.
a1	0.254			0.010		
B	1.39		1.65	0.055		0.065
b		0.45			0.018	
b1		0.25		0.010		
D			25.4			1.000
E		8.5		0.335		
e		2.54		0.100		
e3		22.86		0.900		
F			7.1			0.280
I			3.93			0.155
L		3.3		0.130		
Z			1.34			0.053

OUTLINE AND MECHANICAL DATA

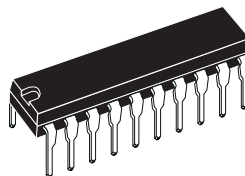

DIP20

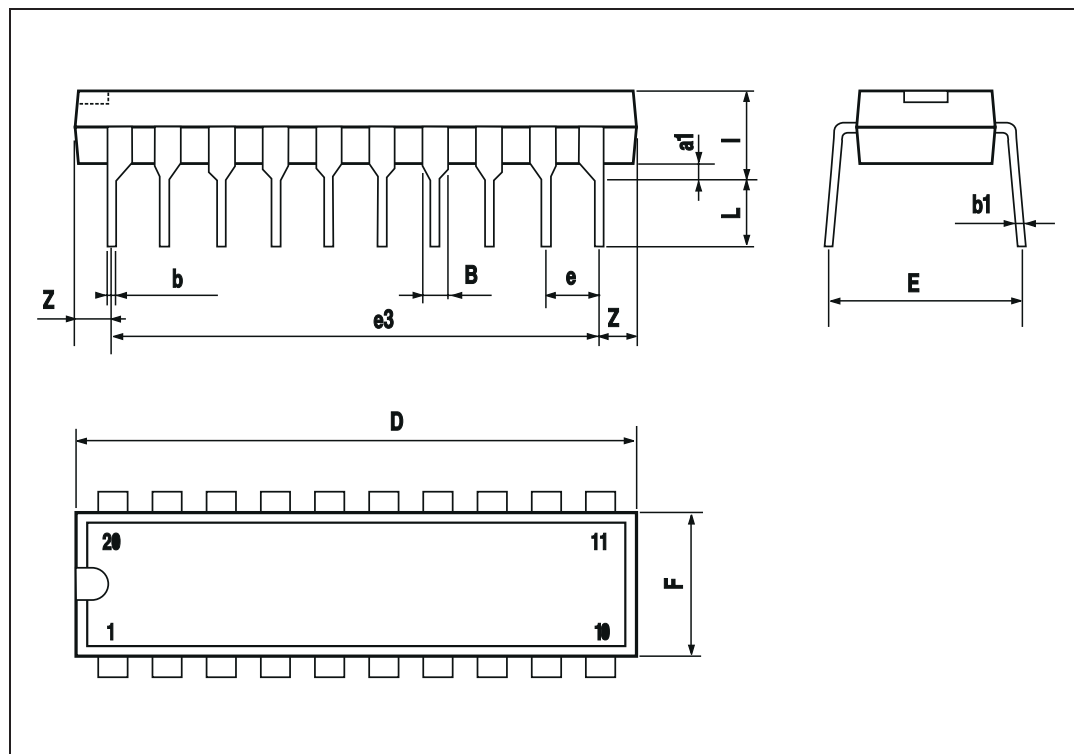
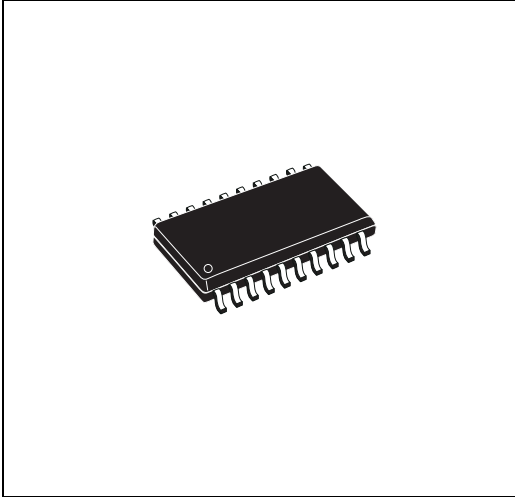

Figure 21. SO20 Mechanical Data & Package Dimensions

DIM.	mm			inch		
	MIN.	TYP.	MAX.	MIN.	TYP.	MAX.
A	2.35		2.65	0.093		0.104
A1	0.10		0.30	0.004		0.012
B	0.33		0.51	0.013		0.200
C	0.23		0.32	0.009		0.013
D (1)	12.60		13.00	0.496		0.512
E	7.40		7.60	0.291		0.299
e		1.27			0.050	
H	10.0		10.65	0.394		0.419
h	0.25		0.75	0.010		0.030
L	0.40		1.27	0.016		0.050
k	0° (min.), 8° (max.)					
ddd			0.10			0.004

(1) "D" dimension does not include mold flash, protusions or gate burrs. Mold flash, protusions or gate burrs shall not exceed 0.15mm per side.

OUTLINE AND MECHANICAL DATA



SO20

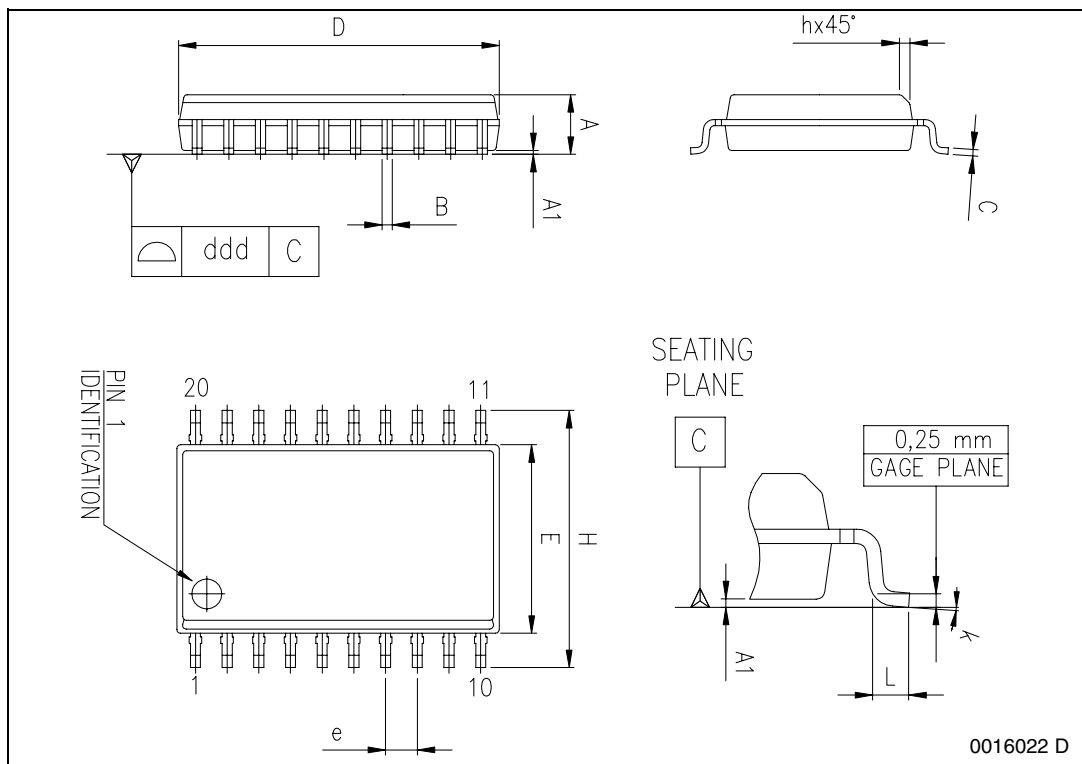

0016022 D

Table 13. Revision History

Date	Revision	Description of Changes
January 2004	5	First Issue in EDOCS DMS
March 2006	6	Modified on the page 8/14 the "MAX CLOCK SPEED" to 400kbits/s.

Please Read Carefully:

Information in this document is provided solely in connection with ST products. STMicroelectronics NV and its subsidiaries ("ST") reserve the right to make changes, corrections, modifications or improvements, to this document, and the products and services described herein at any time, without notice.

All ST products are sold pursuant to ST's terms and conditions of sale.

Purchasers are solely responsible for the choice, selection and use of the ST products and services described herein, and ST assumes no liability whatsoever relating to the choice, selection or use of the ST products and services described herein.

No license, express or implied, by estoppel or otherwise, to any intellectual property rights is granted under this document. If any part of this document refers to any third party products or services it shall not be deemed a license grant by ST for the use of such third party products or services, or any intellectual property contained therein or considered as a warranty covering the use in any manner whatsoever of such third party products or services or any intellectual property contained therein.

UNLESS OTHERWISE SET FORTH IN ST'S TERMS AND CONDITIONS OF SALE ST DISCLAIMS ANY EXPRESS OR IMPLIED WARRANTY WITH RESPECT TO THE USE AND/OR SALE OF ST PRODUCTS INCLUDING WITHOUT LIMITATION IMPLIED WARRANTIES OF MERCHANTABILITY, FITNESS FOR A PARTICULAR PURPOSE (AND THEIR EQUIVALENTS UNDER THE LAWS OF ANY JURISDICTION), OR INFRINGEMENT OF ANY PATENT, COPYRIGHT OR OTHER INTELLECTUAL PROPERTY RIGHT. UNLESS EXPRESSLY APPROVED IN WRITING BY AN AUTHORIZED REPRESENTATIVE OF ST, ST PRODUCTS ARE NOT DESIGNED, AUTHORIZED OR WARRANTED FOR USE IN MILITARY, AIR CRAFT, SPACE, LIFE SAVING, OR LIFE SUSTAINING APPLICATIONS, NOR IN PRODUCTS OR SYSTEMS, WHERE FAILURE OR MALFUNCTION MAY RESULT IN PERSONAL INJURY, DEATH, OR SEVERE PROPERTY OR ENVIRONMENTAL DAMAGE.

Resale of ST products with provisions different from the statements and/or technical features set forth in this document shall immediately void any warranty granted by ST for the ST product or service described herein and shall not create or extend in any manner whatsoever, any liability of ST.

ST and the ST logo are trademarks or registered trademarks of ST in various countries.

Information in this document supersedes and replaces all information previously supplied.

The ST logo is a registered trademark of STMicroelectronics. All other names are the property of their respective owners.

© 2006 STMicroelectronics - All rights reserved

STMicroelectronics group of companies

Australia - Belgium - Brazil - Canada - China - Czech Republic - Finland - France - Germany - Hong Kong - India - Israel - Italy - Japan - Malaysia - Malta - Morocco - Singapore - Spain - Sweden - Switzerland - United Kingdom - United States of America

www.st.com