

MOC215-M

MOC216-M

MOC217-M

DESCRIPTION

These devices consist of a gallium arsenide infrared emitting diode optically coupled to a monolithic silicon phototransistor detector, in a surface mountable, small outline, plastic package. They are ideally suited for high density applications, and eliminate the need for through-the-board mounting.

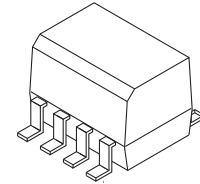

FEATURES

- UL Recognized (File #E90700, Volume 2)
- VDE Recognized (File #13616) (add option "V" for VDE approval, i.e., MOC215V-M)
- Convenient Plastic SOIC-8 Surface Mountable Package Style
- Low LED Input Current Required, for Easier Logic Interfacing
- Standard SOIC-8 Footprint, with 0.050" Lead Spacing
- Compatible with Dual Wave, Vapor Phase and IR Reflow Soldering
- High Input-Output Isolation of 2500 Vac (rms) Guaranteed

APPLICATIONS

- Low power Logic Circuits
- Interfacing and coupling systems of different potentials and impedances
- Telecommunications equipment
- Portable electronics

Marking Information:

- MOC215-M = 215
- MOC216-M = 216
- MOC217-M = 217

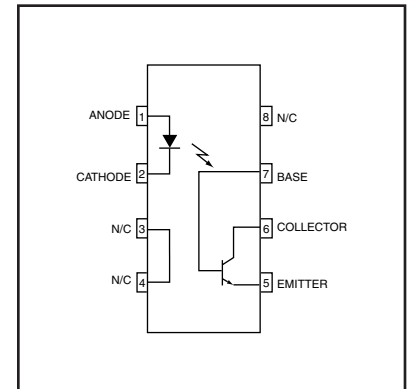

MOC215-M

MOC216-M

MOC217-M

| ABSOLUTE MAXIMUM RATINGS ($T_A = 25^\circ\text{C}$ Unless otherwise specified) | | | |
|--|------------------|--------------|----------------------------|
| Rating | Symbol | Value | Unit |
| EMITTER | | | |
| Forward Current - Continuous | I_F | 60 | mA |
| Forward Current - Peak (PW = 100 μs , 120 pps) | $I_F(\text{pk})$ | 1.0 | A |
| Reverse Voltage | V_R | 6.0 | V |
| LED Power Dissipation @ $T_A = 25^\circ\text{C}$ Derate above 25°C | P_D | 90 0.8 | mW mW/ $^\circ\text{C}$ |
| DETECTOR | | | |
| Collector-Emitter Voltage | V_{CEO} | 30 | V |
| Collector-Base Voltage | V_{CBO} | 70 | V |
| Emitter-Collector Voltage | V_{ECO} | 7.0 | V |
| Collector Current-Continuous | I_C | 150 | mA |
| Detector Power Dissipation @ $T_A = 25^\circ\text{C}$ Derate above 25°C | P_D | 150 1.76 | mW mW/ $^\circ\text{C}$ |
| TOTAL DEVICE | | | |
| Input-Output Isolation Voltage ^(1,2) (60 Hz, 1 minute duration) | V_{ISO} | 2500 | Vac(rms) |
| Total Device Power Dissipation @ $T_A = 25^\circ\text{C}$ Derate above 25°C | P_D | 250 2.94 | mW mW/ $^\circ\text{C}$ |
| Ambient Operating Temperature Range | T_A | -40 to +100 | $^\circ\text{C}$ |
| Storage Temperature Range | T_{stg} | -40 to +125 | $^\circ\text{C}$ |

MOC215-M

MOC216-M

MOC217-M

| ELECTRICAL CHARACTERISTICS ($T_A = 25^\circ\text{C}$ Unless otherwise specified) | | | | | | |
|--|---|------------|-----------------|-------------|-------------|---------------|
| Characteristic | | Symbol | Min | Typ** | Max | Unit |
| EMITTER | | | | | | |
| Forward Voltage | ($I_F = 1.0\text{ mA}$) | V_F | — | 1.07 | 1.3 | V |
| Reverse Leakage Current | ($V_R = 6.0\text{ V}$) | I_R | — | 0.001 | 100 | μA |
| Capacitance | | C | — | 18 | — | pF |
| DETECTOR | | | | | | |
| Collector-Emitter Dark Current | ($V_{CE} = 5.0\text{ V}, T_A = 25^\circ\text{C}$) | I_{CEO} | — | 1.0 | 50 | nA |
| | ($V_{CE} = 5.0\text{ V}, T_A = 100^\circ\text{C}$) | | — | 1.0 | — | μA |
| Collector-Emitter Breakdown Voltage | ($I_C = 100\ \mu\text{A}$) | BV_{CEO} | 30 | 100 | — | V |
| Emitter-Collector Breakdown Voltage | ($I_E = 100\ \mu\text{A}$) | BV_{ECO} | 7.0 | 10 | — | V |
| Collector-Emitter Capacitance | ($f = 1.0\text{ MHz}, V_{CE} = 0$) | C_{CE} | — | 7.0 | — | pF |
| COUPLED | | | | | | |
| Output Collector Current ⁽⁴⁾ | MOC215-M MOC216-M MOC217-M | I_C | 20 50 100 | — — — | — — — | % |
| | ($I_F = 1.0\text{ mA}, V_{CE} = 5.0\text{ V}$) | | | | | |
| Collector-Emitter Saturation Voltage | ($I_C = 100\ \mu\text{A}, I_F = 1.0\text{ mA}$) | | | | | |
| Turn-On Time | ($I_C = 2.0\text{ mA}, V_{CC} = 10\text{ V}, R_L = 100\ \Omega$, fig. 10) | t_{on} | — | 4.0 | — | μs |
| Turn-Off Time | ($I_C = 2.0\text{ mA}, V_{CC} = 10\text{ V}, R_L = 100\ \Omega$, fig. 10) | t_{off} | — | 4.0 | — | μs |
| Rise Time | ($I_C = 2.0\text{ mA}, V_{CC} = 10\text{ V}, R_L = 100\ \Omega$, fig. 10) | t_r | — | 3.0 | — | μs |
| Fall Time | ($I_C = 2.0\text{ mA}, V_{CC} = 10\text{ V}, R_L = 100\ \Omega$, fig. 10) | t_f | — | 3.0 | — | μs |
| Input-Output Isolation Voltage ^(1,2,3) | ($f = 60\text{ Hz}, t = 1.0\text{ min.}$) | V_{ISO} | 2500 | — | — | Vac(rms) |
| Isolation Resistance ⁽²⁾ | ($V_{I-O} = 500\text{ V}$) | R_{ISO} | 10^{11} | — | — | Ω |
| Isolation Capacitance ⁽²⁾ | ($V_{I-O} = 0, f = 1.0\text{ MHz}$) | C_{ISO} | — | 0.2 | — | pF |

** Typical values at $T_A = 25^\circ\text{C}$ unless otherwise noted.

1. Input-Output Isolation Surge Voltage, V_{ISO} , is an internal device dielectric breakdown rating.
2. For this test, Pins 1 and 2 are common and Pins 5, 6 and 7 are common.
3. V_{ISO} rating of 2,500 $V_{AC(RMS)}$ for $t = 1$ minute is equivalent to a rating of 3,000 $V_{AC(RMS)}$ for $t = 1$ second.
4. Current Transfer Ratio (CTR) = $I_C/I_F \times 100\%$.

MOC215-M

MOC216-M

MOC217-M

Fig. 1 LED Forward Voltage vs. Forward Current

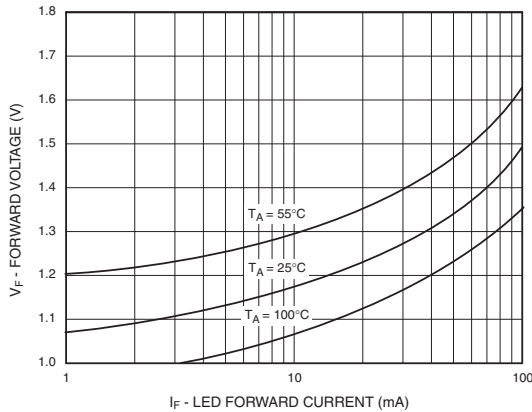

Fig. 2 Output Current vs. Input Current

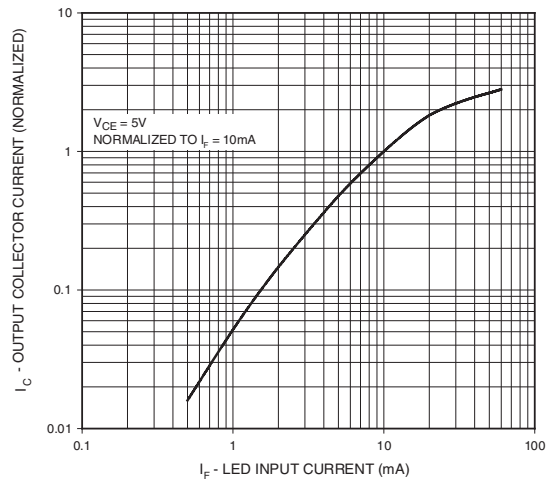

Fig. 3 Output Current vs. Ambient Temperature

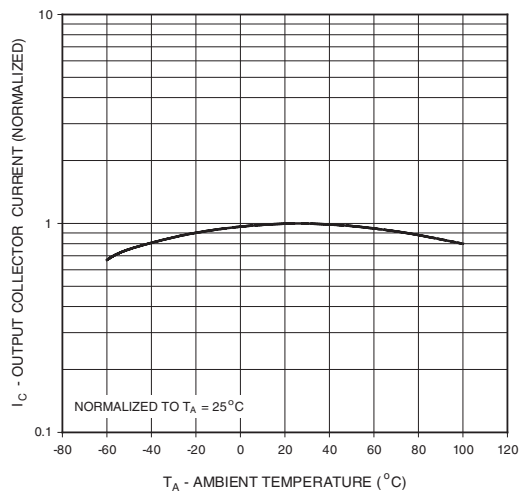

Fig. 4 Output Current vs. Collector - Emitter Voltage

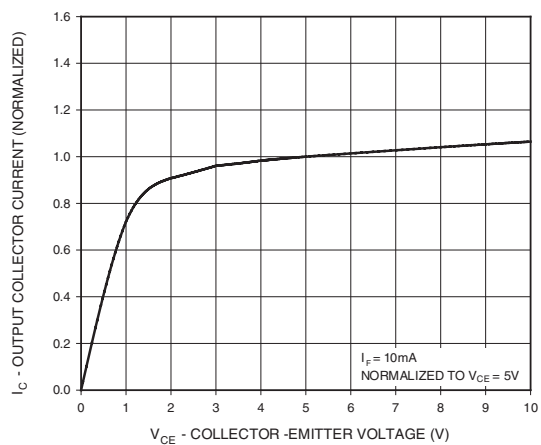

Fig. 5 Dark Current vs. Ambient Temperature

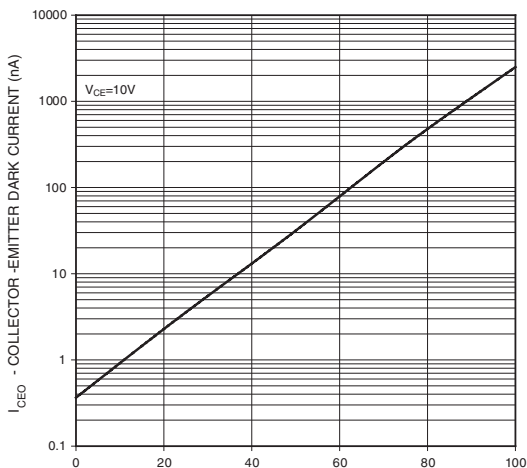
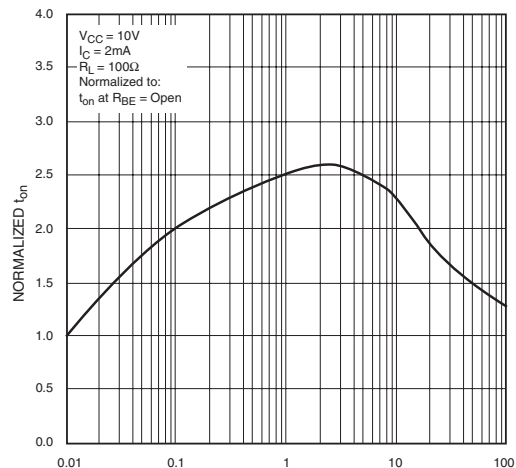

Fig. 6 Normalized t_on vs. R_BE



MOC215-M

MOC216-M

MOC217-M

Fig. 7 Normalized t_{off} vs. R_{BE}

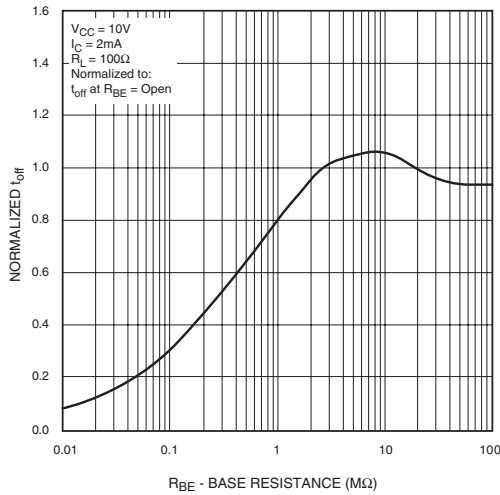

Fig. 8 CTR vs. R_{BE} (Saturated)

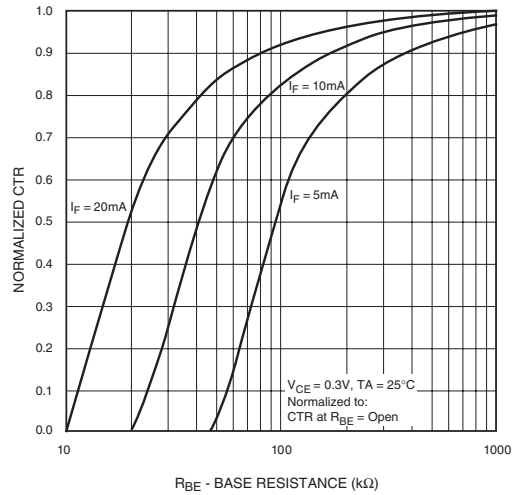
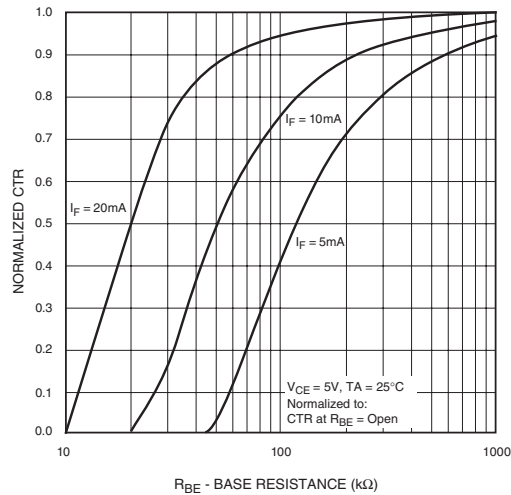

Fig. 9 CTR vs. R_{BE} (Unsaturated)



MOC215-M

MOC216-M

MOC217-M

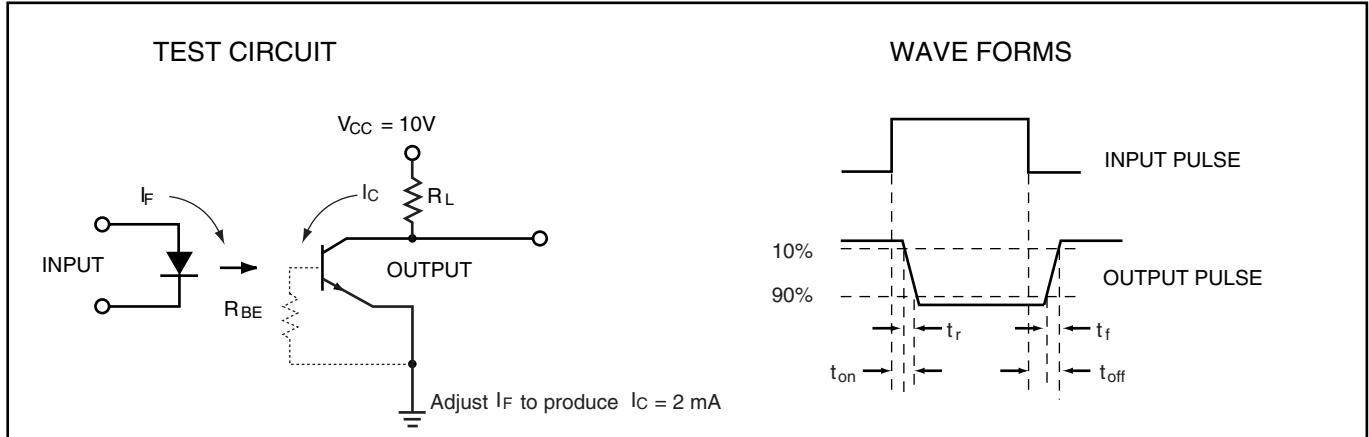
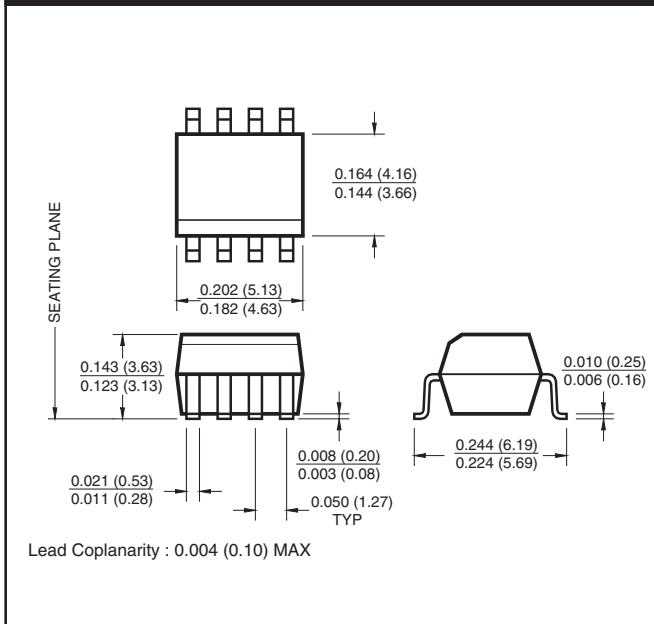
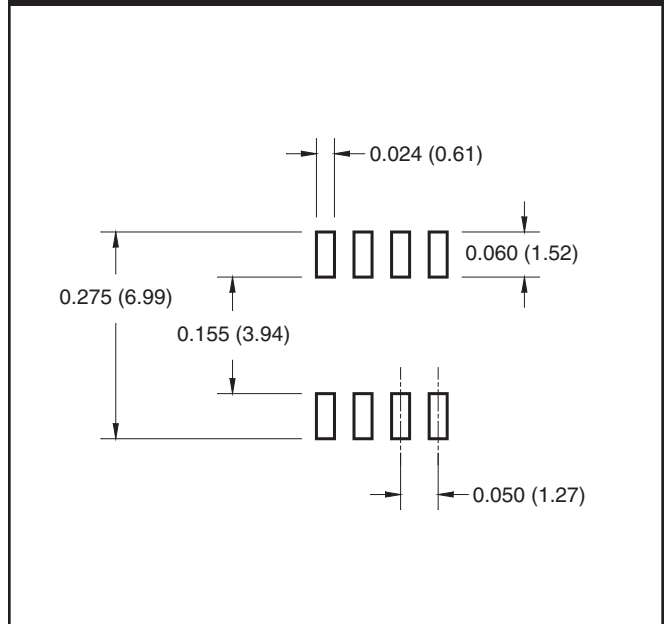

Figure 10. Switching Time Test Circuit and Waveforms

Package Dimensions (Surface Mount)



8-Pin Small Outline



MOC215-M

MOC216-M

MOC217-M

ORDERING INFORMATION

| Option | Order Entry Identifier | Description |
|--------|------------------------|---|
| V | V | VDE 0084 |
| R1 | R1 | Tape and reel (500 units per reel) |
| R1V | R1V | VDE 0884, Tape and reel (500 units per reel) |
| R2 | R2 | Tape and reel (2500 units per reel) |
| R2V | R2V | VDE 0884, Tape and reel (2500 units per reel) |

MARKING INFORMATION

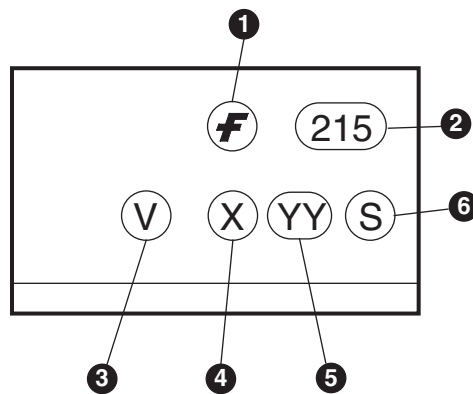

| Definitions | |
|-------------|--|
| 1 | Fairchild logo |
| 2 | Device number |
| 3 | VDE mark (Note: Only appears on parts ordered with VDE option – See order entry table) |
| 4 | One digit year code, e.g., '3' |
| 5 | Two digit work week ranging from '01' to '53' |
| 6 | Assembly package code |

MOC215-M

MOC216-M

MOC217-M

Carrier Tape Specifications

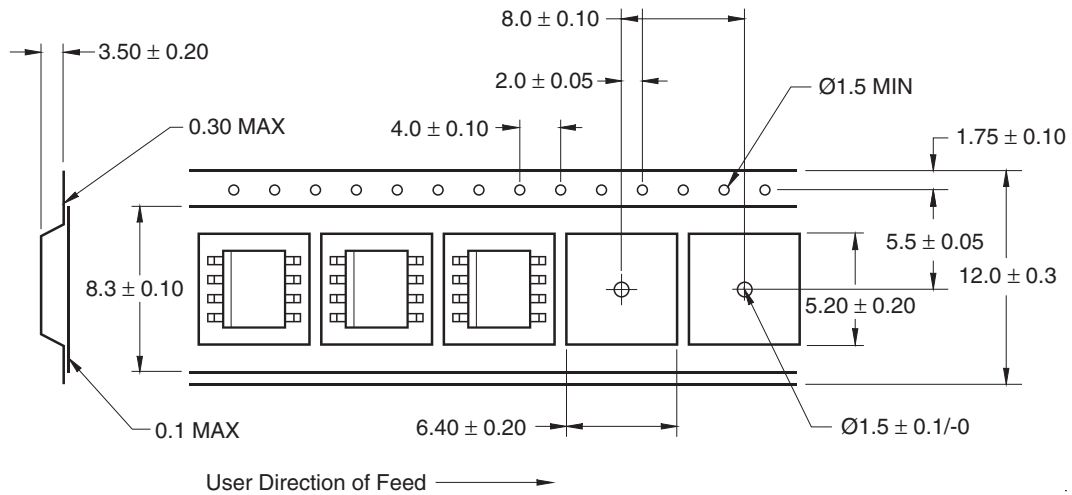

Reflow Profile

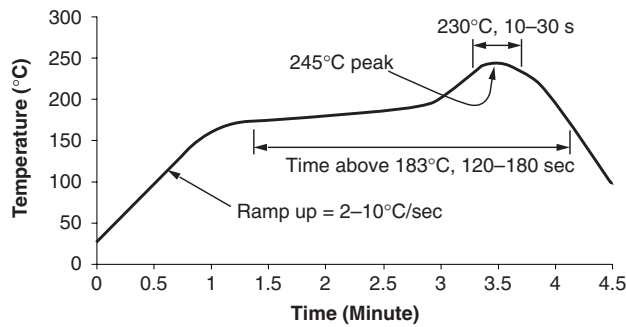

- Peak reflow temperature: 245°C (package surface temperature)
- Time of temperature higher than 183°C for 120-180 seconds
- One time soldering reflow is recommended

MOC215-M

MOC216-M

MOC217-M

DISCLAIMER

FAIRCHILD SEMICONDUCTOR RESERVES THE RIGHT TO MAKE CHANGES WITHOUT FURTHER NOTICE TO ANY PRODUCTS HEREIN TO IMPROVE RELIABILITY, FUNCTION OR DESIGN. FAIRCHILD DOES NOT ASSUME ANY LIABILITY ARISING OUT OF THE APPLICATION OR USE OF ANY PRODUCT OR CIRCUIT DESCRIBED HEREIN; NEITHER DOES IT CONVEY ANY LICENSE UNDER ITS PATENT RIGHTS, NOR THE RIGHTS OF OTHERS.

LIFE SUPPORT POLICY

FAIRCHILD'S PRODUCTS ARE NOT AUTHORIZED FOR USE AS CRITICAL COMPONENTS IN LIFE SUPPORT DEVICES OR SYSTEMS WITHOUT THE EXPRESS WRITTEN APPROVAL OF THE PRESIDENT OF FAIRCHILD SEMICONDUCTOR CORPORATION. As used herein:

1. Life support devices or systems are devices or systems which, (a) are intended for surgical implant into the body, or (b) support or sustain life, and (c) whose failure to perform when properly used in accordance with instructions for use provided in the labeling, can be reasonably expected to result in a significant injury of the user.
2. A critical component in any component of a life support device or system whose failure to perform can be reasonably expected to cause the failure of the life support device or system, or to affect its safety or effectiveness.