

MODEL:

SRCOOL7KRM

SmartRack® Rack-Mounted Air Conditioning Unit



7,000 BTU



EIA/TIA
Compliant



8U Rack Space



Close Coupled
Cooling



Zero-Maintenance
Design



Standard
NEMA 5-15P Plug



Filters and
Dehumidifies Air



Intuitive
LCD Screen

Front View

- A** Directional Vent
- B** Cool Air Output
- C** SRCOOLNET2 Slot
- D** Control Panel
- E** Air Filter
- F** Front Panel
- G** Blocking Plate

Rear View

- H** AC Power Cord
- I** Warm Air Exhaust
- J** Drainage Outlet

Control Panel

- K** Numeric Display
- L** Operating Mode LEDs
- M** Temperature Control Buttons
- N** Fan Speed Mode LEDs
- O** "FAN SPEED" Button
- P** "QUIET" Button
- Q** "TIMER" Button
- R** "FUNCTION" Button
- S** "POWER" Button

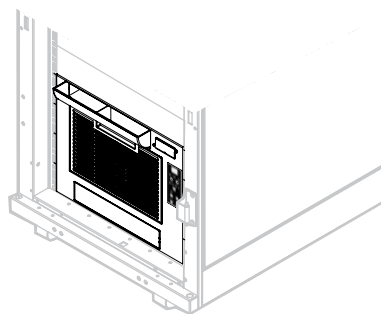

Note: Mount unit only at bottom of rack as shown.

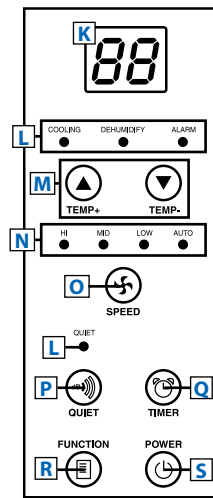
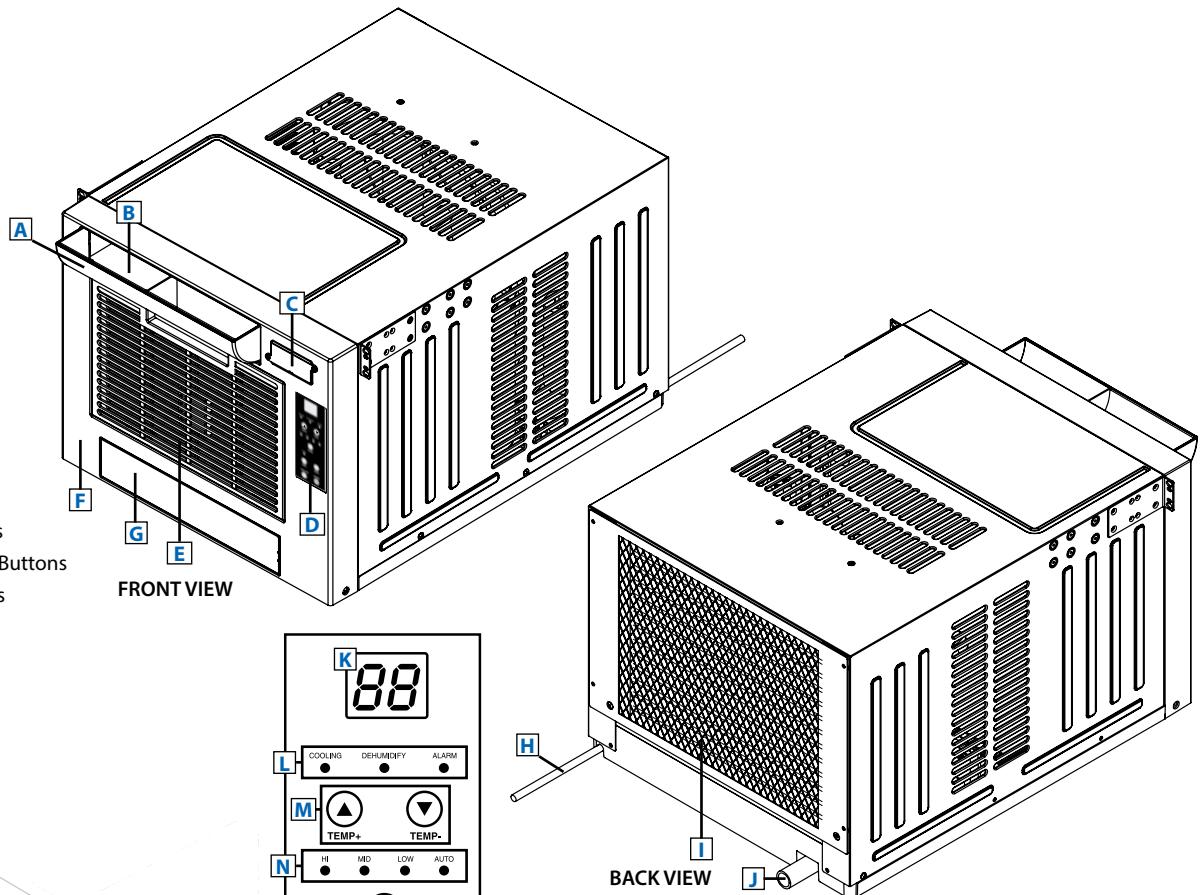

CONTROL PANEL

- Saves valuable floor space in IT environments with 8U available rack space
- Saves energy with efficient close-coupled cooling, directing air upward to cool only the equipment inside the rack enclosure instead of the entire room
- 7,000 BTU of cooling power
- Built-in evaporator eliminates condensation—no floor drain or water collection tank needed
- Features remote control capability (requires optional SRCOOLNET2 Web Management Accessory, sold separately)

SEE NEXT PAGE FOR DETAILED UNIT MEASUREMENTS

Specifications

Model	SRCOOL7K
Rack Spaces	8U
Cooling Capacity	7000 BTU / 2.0 kW
Input Voltage	120V, 60Hz AC
Power Consumption	1020W Max
Input Cord / Connector	7 ft., NEMA 5-15P
Unit Dimensions	13.9 x 17.35 x 22.52 in. / 353 x 441 x 572 mm
Shipping Dimensions	23.4 x 22.8 x 27.7 in. / 594 x 579 x 704 mm
Unit Weight	61.6 lb. / 28 kg
Shipping Weight	77.2 lb. / 35 kg
Standards	Tested to UL 484, CSA and RoHS standards

Tripp Lite has a policy of continuous improvement. Specifications are subject to change without notice.



1111 W. 35th Street
Chicago, IL 60609 USA
773.869.1234
www.triplite.com

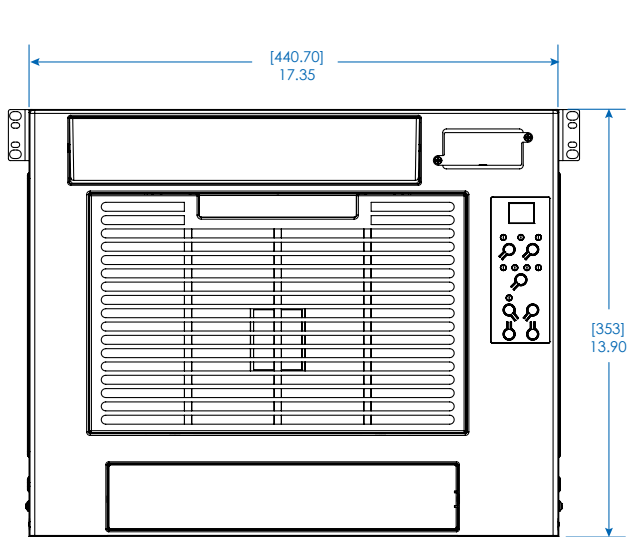

FRONT VIEW

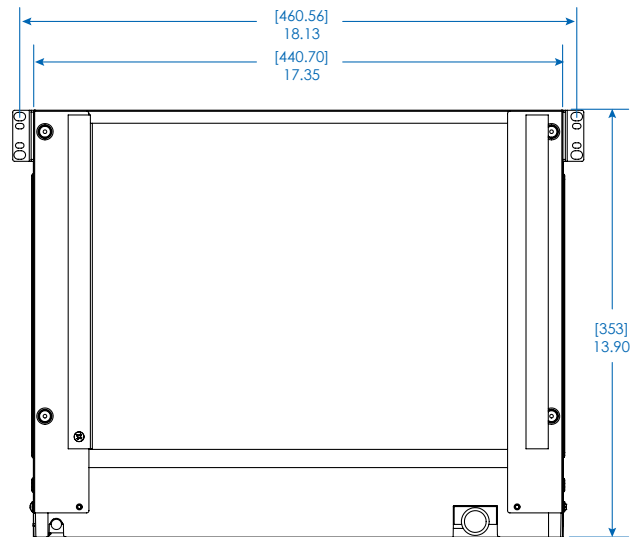

BACK VIEW

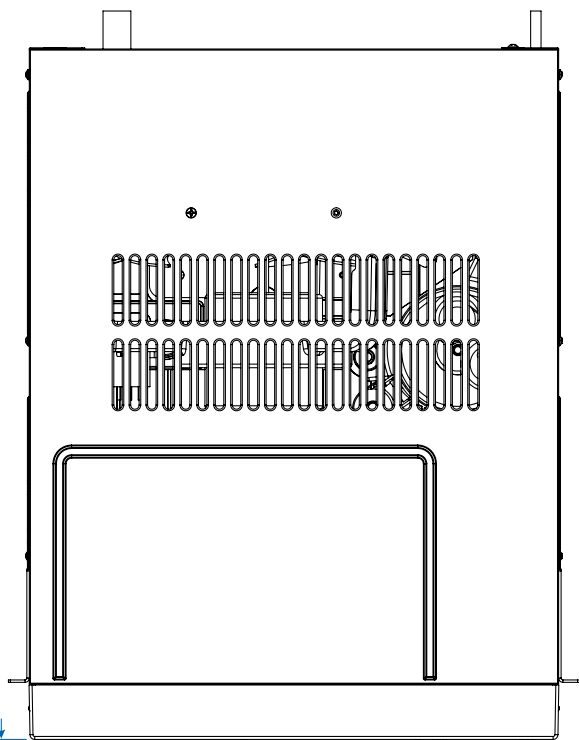

TOP VIEW

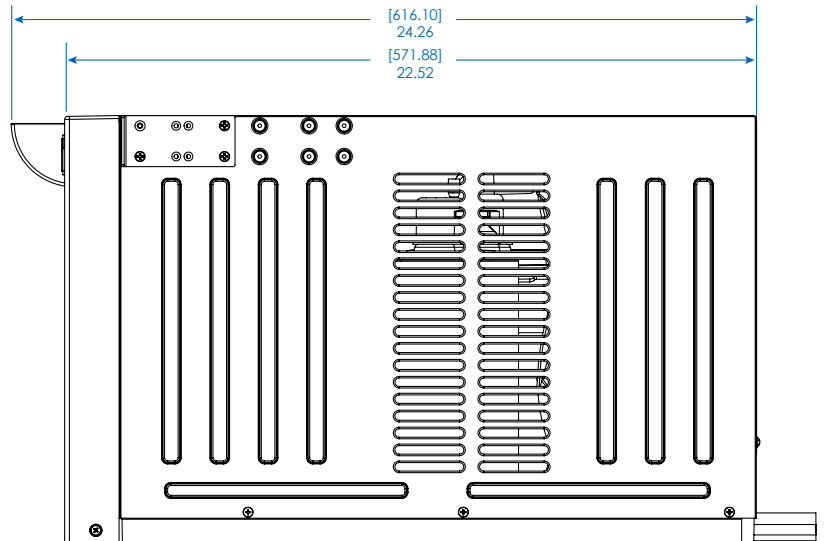

SIDE VIEW

Dimensions: [mm] INCHES

Tripp Lite has a policy of continuous improvement. Specifications are subject to change without notice.

MODEL:
SRCOOL7KRM
TRIPP·LITE

1111 W. 35th Street
 Chicago, IL 60609 USA
 773.869.1234
 www.triplite.com