

TOLERANCE UNLESS OTHERWISE SPECIFIED IN MM:
 ANGLE±0.5°
 0. ± 0.30
 0.0 ± 0.25
 0.00 ± 0.20
 0.000 ± 0.10

THIS IS A C.A.D. GENERATED DRAWING
 DO NOT MAKE MANUAL REVISIONS TO MASTER.

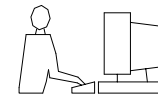

ISSUE NUMBER

ORIGINAL

1

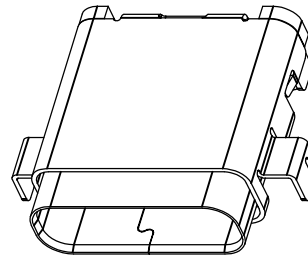
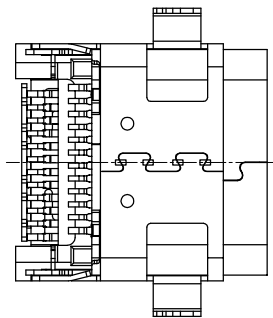
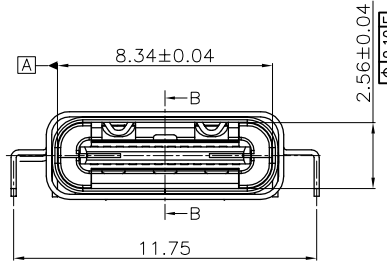
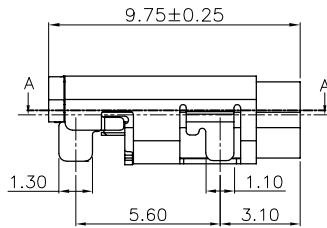
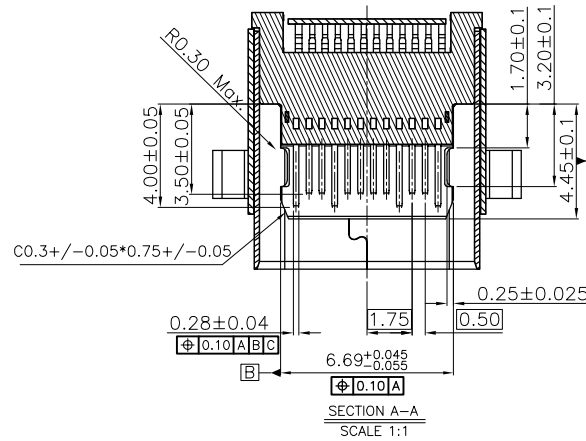
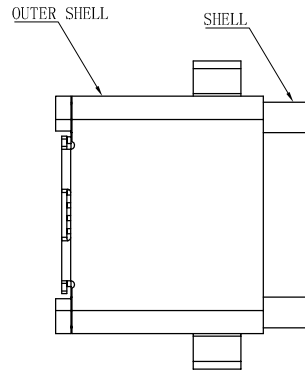

NOTES:

1.MATERIAL:

HOUSING: THERMOPLASTIC,UL94V-0,COLOR:BLACK
 CONTACT: COPPER ALLOY
 SHELL: STAINLESS STEEL
 GUARD: STAINLESS STEEL
 SPRING: STAINLESS STEEL

2.Finish:

CONTACT: GOLD PLATING ON CONTACT AREA
 GOLD FLASH PLATING ON SOLDER TAILS
 80u"Min Ni UNDERPLATING OVER ALL
 SHELL: 50u"Min Ni PLATING OVER ALL.

3.PRODUCT SPECIFICATION:

VOLTAGE RATING:100V AC
 INSULATION RESISTANCE:100M Ω MIN
 CONTACT RESISTANCE: 40mΩ MAX
 INSERT FORCE: 5-20N MAX.
 EXTRACT FORCE: 8-20N MIN.
 DURABILITY: 10000 CYCLES

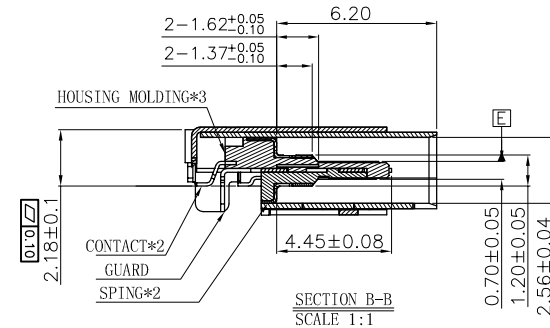

PART NUMBERS

GOLD FLASH	690-024-233-031
15u"GOLD	690-024-333-031
30u"GOLD	690-024-633-031



THIS SERIES FULLY CONFORMS TO THE EUROPEAN UNION DIRECTIVES 2011/65/EU FOR RoHS COMPLIANCY.

USB 3.1 TYPE C FEMALE SMT



EDAC INC
 TORONTO, ONTARIO
 CANADA

YOUR CONNECTION TO QUALITY & SERVICE

THESE DRAWINGS AND SPECIFICATIONS ARE THE PROPERTY OF EDAC INC., AND SHALL NOT BE REPRODUCED, OR COPIED OR USED AS THE BASIS FOR THE MANUFACTURE OR SALE OF APPARATUS WITHOUT WRITTEN PERMISSION.

ACAD REFERENCE NO.: 690-024-233-031

DRAWN: N.SONDH

DATE: JUN.24/2015

CHECKED:

DATE:

PART NUMBER

SEE TABLE

SHEET 1 OF 2

DRAWING NUMBER

690-024-233-031

ISSUE

1

TOLERANCE UNLESS OTHERWISE SPECIFIED IN MM:
 ANGLE±0.5°
 0. ± 0.30
 0.0 ± 0.25
 0.00 ± 0.20
 0.000 ± 0.10

THIS IS A C.A.D. GENERATED DRAWING
 DO NOT MAKE MANUAL REVISIONS TO MASTER.

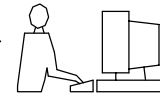

ISSUE NUMBER

ORIGINAL

1

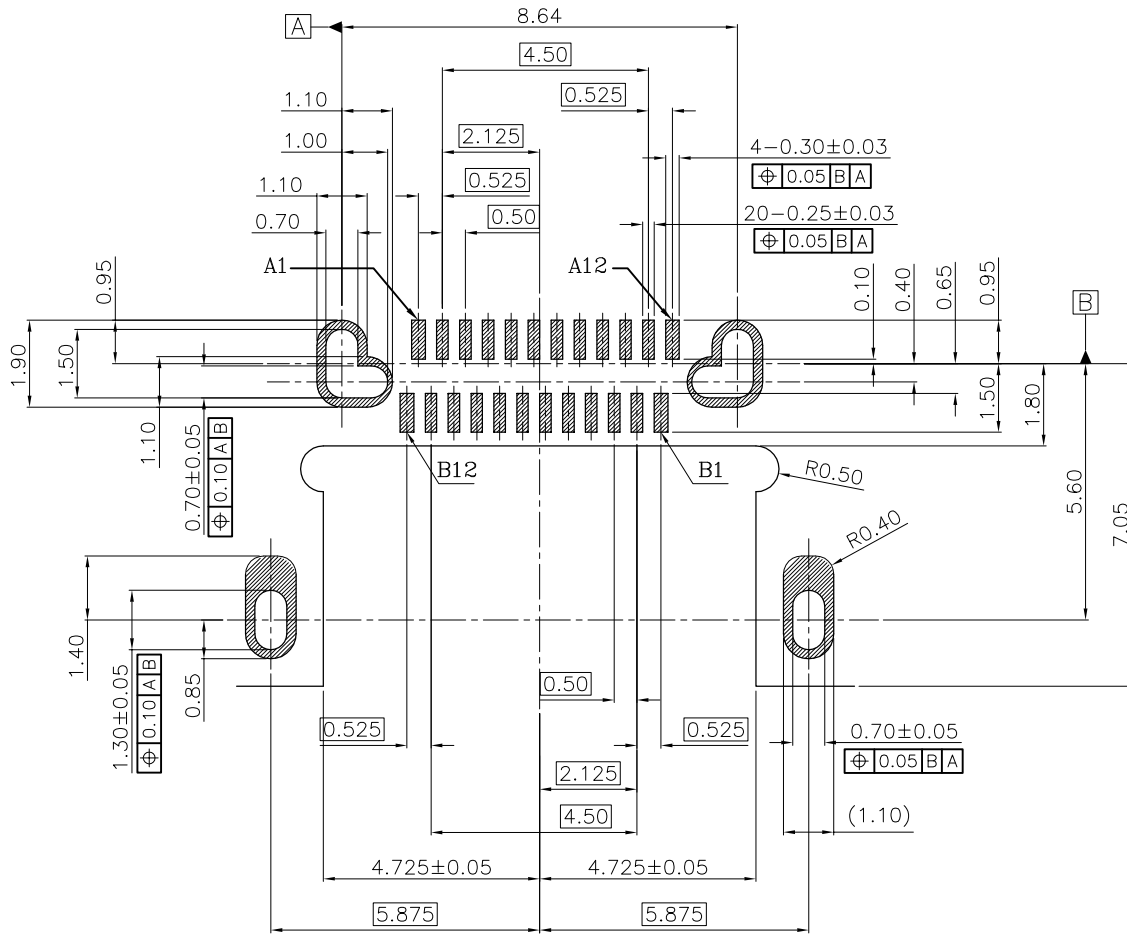

RECOMMEND PCB LAYOUT
 (THICKNESS: 1.00 OR 1.20mm)

USB TYPE-C FULL-FEATURED RECEPTACLE INTERFACE PIN ASSIGNMENTS

PIN	Signal Name	Description	PIN	Signal Name	Description
A1	GND	Ground return	B12	GND	Ground return
A2	SSTXp1	Positive half of first SuperSpeed TX differential pair	B11	SSRXp1	Positive half of first SuperSpeed RX differential pair
A3	SSTXn1	Negative half of first SuperSpeed TX differential pair	B10	SSRXn1	Negative half of first SuperSpeed RX differential pair
A4	VBUS	Bus Power	B9	Vbus	Bus Power
A5	CC1	Configuration Channel	B8	SBU2	Sideband Use (SBU)
A6	Dp1	Positive half of the USB 2.0 differential pair-Position 1	B7	Dn2	Negative half of the USB 2.0 differential pair-Position 2
A7	Dn1	Negative half of the USB 2.0 differential pair-Position 1	B6	Dp2	Positive half of the USB 2.0 differential pair-Position 2
A8	SBU1	Sideband Use (SBU)	B5	CC2	Configuration Channel
A9	VBUS	Bus Power	B4	VBUS	Bus Power
A10	SSRXn2	Negative half of second SuperSpeed RX differential pair	B3	SSTXn2	Negative half of second SuperSpeed TX differential pair
A11	SSRXp2	Positive half of second SuperSpeed RX differential pair	B2	SSTXp2	Positive half of second SuperSpeed TX differential pair
A12	GND	Ground return	B1	GND	Ground return



THIS SERIES FULLY CONFORMS TO THE EUROPEAN UNION DIRECTIVES 2011/65/EU FOR RoHS COMPLIANCY.

USB 3.1 TYPE C FEMALE SMT



EDAC INC
 TORONTO, ONTARIO
 CANADA

YOUR CONNECTION TO QUALITY & SERVICE

THESE DRAWINGS AND SPECIFICATIONS ARE THE PROPERTY OF EDAC INC. AND SHALL NOT BE REPRODUCED, OR COPIED OR USED AS THE BASIS FOR THE MANUFACTURE OR SALE OF APPARATUS WITHOUT WRITTEN PERMISSION.

ACAD REFERENCE NO.: 690-024-233-031

DRAWN: N.SONDH

DATE: JUN.24/2015

CHECKED:

DATE:

PART NUMBER

SEE TABLE

SHEET 2 OF 2

DRAWING NUMBER

690-024-233-031

ISSUE

1