

## L, S-BAND SPDT SWITCH

### DESCRIPTION

The μPG2214TK is a GaAs MMIC for L, S-band SPDT (Single Pole Double Throw) switch which was developed for mobile phone and another L, S-band application.

This device can operate 2 control switching by control voltage 1.8 to 5.3 V. This device can operate frequency from 0.05 to 3.0 GHz, having the low insertion loss and high isolation.

This device is housed in a 6-pin lead-less minimold (1511) package. And this package is able to high-density surface mounting.

### FEATURES

- Switch control voltage :  $V_{\text{cont (H)}} = 1.8 \text{ to } 5.3 \text{ V (3.0 V TYP.)}$   
:  $V_{\text{cont (L)}} = -0.2 \text{ to } +0.2 \text{ V (0 V TYP.)}$
- Low insertion loss :  $L_{\text{ins1}} = 0.25 \text{ dB TYP. @ } f = 0.05 \text{ to } 0.5 \text{ GHz, } V_{\text{cont (H)}} = 3.0 \text{ V, } V_{\text{cont (L)}} = 0 \text{ V}$   
:  $L_{\text{ins2}} = 0.25 \text{ dB TYP. @ } f = 0.5 \text{ to } 1.0 \text{ GHz, } V_{\text{cont (H)}} = 3.0 \text{ V, } V_{\text{cont (L)}} = 0 \text{ V}$   
:  $L_{\text{ins3}} = 0.30 \text{ dB TYP. @ } f = 1.0 \text{ to } 2.0 \text{ GHz, } V_{\text{cont (H)}} = 3.0 \text{ V, } V_{\text{cont (L)}} = 0 \text{ V}$   
:  $L_{\text{ins4}} = 0.35 \text{ dB TYP. @ } f = 2.0 \text{ to } 2.5 \text{ GHz, } V_{\text{cont (H)}} = 3.0 \text{ V, } V_{\text{cont (L)}} = 0 \text{ V}$   
:  $L_{\text{ins5}} = 0.35 \text{ dB TYP. @ } f = 2.5 \text{ to } 3.0 \text{ GHz, } V_{\text{cont (H)}} = 3.0 \text{ V, } V_{\text{cont (L)}} = 0 \text{ V}$
- High isolation :  $ISL1 = 32 \text{ dB TYP. @ } f = 0.05 \text{ to } 0.5 \text{ GHz, } V_{\text{cont (H)}} = 3.0 \text{ V, } V_{\text{cont (L)}} = 0 \text{ V}$   
:  $ISL2 = 28 \text{ dB TYP. @ } f = 0.5 \text{ to } 1.0 \text{ GHz, } V_{\text{cont (H)}} = 3.0 \text{ V, } V_{\text{cont (L)}} = 0 \text{ V}$   
:  $ISL3 = 27 \text{ dB TYP. @ } f = 1.0 \text{ to } 2.0 \text{ GHz, } V_{\text{cont (H)}} = 3.0 \text{ V, } V_{\text{cont (L)}} = 0 \text{ V}$   
:  $ISL4 = 26 \text{ dB TYP. @ } f = 2.0 \text{ to } 2.5 \text{ GHz, } V_{\text{cont (H)}} = 3.0 \text{ V, } V_{\text{cont (L)}} = 0 \text{ V}$   
:  $ISL5 = 24 \text{ dB TYP. @ } f = 2.5 \text{ to } 3.0 \text{ GHz, } V_{\text{cont (H)}} = 3.0 \text{ V, } V_{\text{cont (L)}} = 0 \text{ V}$
- Handling power :  $P_{\text{in (1 dB)}} = +27.0 \text{ dBm TYP. @ } f = 0.5 \text{ to } 3.0 \text{ GHz, } V_{\text{cont (H)}} = 3.0 \text{ V, } V_{\text{cont (L)}} = 0 \text{ V}$   
:  $P_{\text{in (1 dB)}} = +20.0 \text{ dBm TYP. @ } f = 0.5 \text{ to } 3.0 \text{ GHz, } V_{\text{cont (H)}} = 1.8 \text{ V, } V_{\text{cont (L)}} = 0 \text{ V}$
- High-density surface mounting : 6-pin lead-less minimold package (1.5 × 1.1 × 0.55 mm)

### APPLICATIONS

- L, S-band digital cellular or cordless telephone
- W-LAN, WLL and Bluetooth™ etc.

### ORDERING INFORMATION

Part Number	Package	Marking	Supplying Form
μPG2214TK-E2	6-pin lead-less minimold (1511)	G4K	<ul style="list-style-type: none"> <li>• Embossed tape 8 mm wide</li> <li>• Pin 1, 6 face the perforation side of the tape</li> <li>• Qty 5 kpcs/reel</li> </ul>

**Remark** To order evaluation samples, contact your nearby sales office.

Part number for sample order: μPG2214TK-A

**Caution: Observe precautions when handling because these devices are sensitive to electrostatic discharge**

The information in this document is subject to change without notice. Before using this document, please confirm that this is the latest version.

**PIN CONNECTIONS AND INTERNAL BLOCK DIAGRAM**

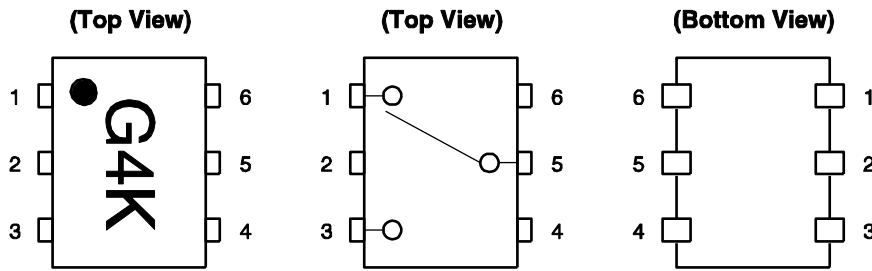

Pin No.	Pin Name
1	OUTPUT1
2	GND
3	OUTPUT2
4	V <sub>cont2</sub>
5	INPUT
6	V <sub>cont1</sub>

**TRUTH TABLE**

V <sub>cont1</sub>	V <sub>cont2</sub>	INPUT-OUTPUT1	INPUT-OUTPUT2
Low	High	ON	OFF
High	Low	OFF	ON

**ABSOLUTE MAXIMUM RATINGS (T<sub>A</sub> = +25°C, unless otherwise specified)**

Parameter	Symbol	Ratings	Unit
Switch Control Voltage	V <sub>cont</sub>	+6.0 <sup>Note</sup>	V
Input Power	P <sub>in</sub>	+30	dBm
Operating Ambient Temperature	T <sub>A</sub>	-45 to +85	°C
Storage Temperature	T <sub>stg</sub>	-55 to +150	°C

**Note** |V<sub>cont1</sub> - V<sub>cont2</sub>| ≤ 6.0 V

**RECOMMENDED OPERATING RANGE (T<sub>A</sub> = +25°C, unless otherwise specified)**

Parameter	Symbol	MIN.	TYP.	MAX.	Unit
Switch Control Voltage (H)	V <sub>cont (H)</sub>	1.8	3.0	5.3	V
Switch Control Voltage (L)	V <sub>cont (L)</sub>	-0.2	0	0.2	V

**ELECTRICAL CHARACTERISTICS**

(T<sub>A</sub> = +25°C, V<sub>cont</sub> (H) = 3.0 V, V<sub>cont</sub> (L) = 0 V, DC cut capacitors = 100 pF, unless otherwise specified)

Parameter	Symbol	Test Conditions	MIN.	TYP.	MAX.	Unit
Insertion Loss 1	L <sub>ins1</sub>	f = 0.05 to 0.5 GHz <sup>Note 1</sup>	–	0.25	0.45	dB
Insertion Loss 2	L <sub>ins2</sub>	f = 0.5 to 1.0 GHz	–	0.25	0.45	dB
Insertion Loss 3	L <sub>ins3</sub>	f = 1.0 to 2.0 GHz	–	0.30	0.50	dB
Insertion Loss 4	L <sub>ins4</sub>	f = 2.0 to 2.5 GHz	–	0.35	0.55	dB
Insertion Loss 5	L <sub>ins5</sub>	f = 2.5 to 3.0 GHz	–	0.35	0.60	dB
Isolation 1	ISL1	f = 0.05 to 0.5 GHz <sup>Note 1</sup>	29	32	–	dB
Isolation 2	ISL2	f = 0.5 to 1.0 GHz	25	28	–	dB
Isolation 3	ISL3	f = 1.0 to 2.0 GHz	24	27	–	dB
Isolation 4	ISL4	f = 2.0 to 2.5 GHz	23	26	–	dB
Isolation 5	ISL5	f = 2.5 to 3.0 GHz	21	24	–	dB
Input Return Loss 1	RL <sub>in1</sub>	f = 0.05 to 0.5 GHz <sup>Note 1</sup>	15	20	–	dB
Input Return Loss 2	RL <sub>in2</sub>	f = 0.5 to 3.0 GHz	15	20	–	dB
Output Return Loss 1	RL <sub>out1</sub>	f = 0.05 to 0.5 GHz <sup>Note 1</sup>	15	20	–	dB
Output Return Loss 2	RL <sub>out2</sub>	f = 0.5 to 3.0 GHz	15	20	–	dB
0.1 dB Loss Compression Input Power <sup>Note 2</sup>	P <sub>in (0.1 dB)</sub>	f = 2.0/2.5 GHz	+21.0	+23.0	–	dBm
		f = 0.5 to 3.0 GHz	–	+23.0	–	dBm
1 dB Loss Compression Input Power <sup>Note 3</sup>	P <sub>in (1 dB)</sub>	f = 0.5 to 3.0 GHz	–	+27.0	–	dBm
2nd Harmonics	2f <sub>0</sub>	f = 2.0 GHz, P <sub>in</sub> = +15 dBm	–	–55	–47	dBc
		f = 2.5 GHz, P <sub>in</sub> = +15 dBm	–	–55	–47	dBc
3rd Harmonics	3f <sub>0</sub>	f = 2.0 GHz, P <sub>in</sub> = +15 dBm	–	–55	–47	dBc
		f = 2.5 GHz, P <sub>in</sub> = +15 dBm	–	–55	–47	dBc
Intermodulation Intercept Point	IIP <sub>3</sub>	f = 0.5 to 3.0 GHz, 2 tone, P <sub>in</sub> = +16 dBm, 5 MHz spicing	–	+58	–	dBm
Switch Control Current	I <sub>cont</sub>		–	4	20	μA
Switch Control Speed	t <sub>sw</sub>	50% CTL to 90/10% RF	–	20	200	ns

**Notes 1.** DC cut capacitors = 1 000 pF at f = 0.05 to 0.5 GHz

- 2.** P<sub>in (0.1 dB)</sub> is measured the input power level when the insertion loss increases more 0.1 dB than that of linear range.
- 3.** P<sub>in (1 dB)</sub> is measured the input power level when the insertion loss increases more 1 dB than that of linear range.

**ELECTRICAL CHARACTERISTICS**

(T<sub>A</sub> = +25°C, V<sub>cont</sub> (H) = 1.8 V, V<sub>cont</sub> (L) = 0 V, DC cut capacitors = 100 pF, unless otherwise specified)

Parameter	Symbol	Test Conditions	MIN.	TYP.	MAX.	Unit
Insertion Loss 6	L <sub>ins6</sub>	f = 0.05 to 0.5 GHz <sup>Note 1</sup>	–	0.25	0.50	dB
Insertion Loss 7	L <sub>ins7</sub>	f = 0.5 to 1.0 GHz	–	0.25	0.50	dB
Insertion Loss 8	L <sub>ins8</sub>	f = 1.0 to 2.0 GHz	–	0.30	0.55	dB
Insertion Loss 9	L <sub>ins9</sub>	f = 2.0 to 2.5 GHz	–	0.35	0.60	dB
Insertion Loss 10	L <sub>ins10</sub>	f = 2.5 to 3.0 GHz	–	0.35	0.65	dB
Isolation 6	ISL6	f = 0.05 to 0.5 GHz <sup>Note 1</sup>	27	30	–	dB
Isolation 7	ISL7	f = 0.5 to 2.0 GHz	23	27	–	dB
Isolation 8	ISL8	f = 2.0 to 2.5 GHz	21	25	–	dB
Isolation 9	ISL9	f = 2.5 to 3.0 GHz	20	24	–	dB
Input Return Loss 3	RL <sub>in3</sub>	f = 0.05 to 3.0 GHz <sup>Note 1</sup>	15	20	–	dB
Output Return Loss 3	RL <sub>out3</sub>	f = 0.05 to 3.0 GHz <sup>Note 1</sup>	15	20	–	dB
0.1 dB Loss Compression Input Power <sup>Note 2</sup>	P <sub>in (0.1 dB)</sub>	f = 2.0/2.5 GHz	+14.0	+17.0	–	dBm
		f = 0.5 to 3.0 GHz	–	+17.0	–	dBm
1 dB Loss Compression Input Power <sup>Note 3</sup>	P <sub>in (1 dB)</sub>	f = 0.5 to 3.0 GHz	–	+20.0	–	dBm
Switch Control Current	I <sub>cont</sub>		–	4	20	μA
Switch Control Speed	t <sub>sw</sub>	50% CTL to 90/10% RF	–	20	200	ns

**Notes 1.** DC cut capacitors = 1 000 pF at f = 0.05 to 0.5 GHz

- 2.** P<sub>in (0.1 dB)</sub> is measured the input power level when the insertion loss increases more 0.1 dB than that of linear range.
- 3.** P<sub>in (1 dB)</sub> is measured the input power level when the insertion loss increases more 1 dB than that of linear range.

**Caution** This device is used it is necessary to use DC cut capacitors.

The value of DC cut capacitors should be chosen to accommodate the frequency of operation, bandwidth, switching speed and the condition with actual board of your system. The range of recommended DC cut capacitor value is less than 100 pF.

EVALUATION CIRCUIT

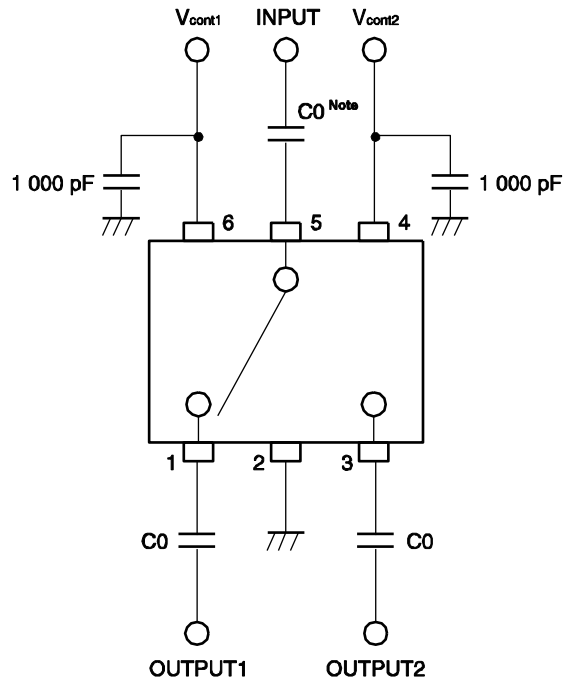

**Note** C0 : 0.05 to 0.5 GHz 1 000 pF  
 : 0.5 to 3.0 GHz 100 pF

The application circuits and their parameters are for reference only and are not intended for use in actual design-ins.

ILLUSTRATION OF THE TEST CIRCUIT ASSEMBLED ON EVALUATION BOARD

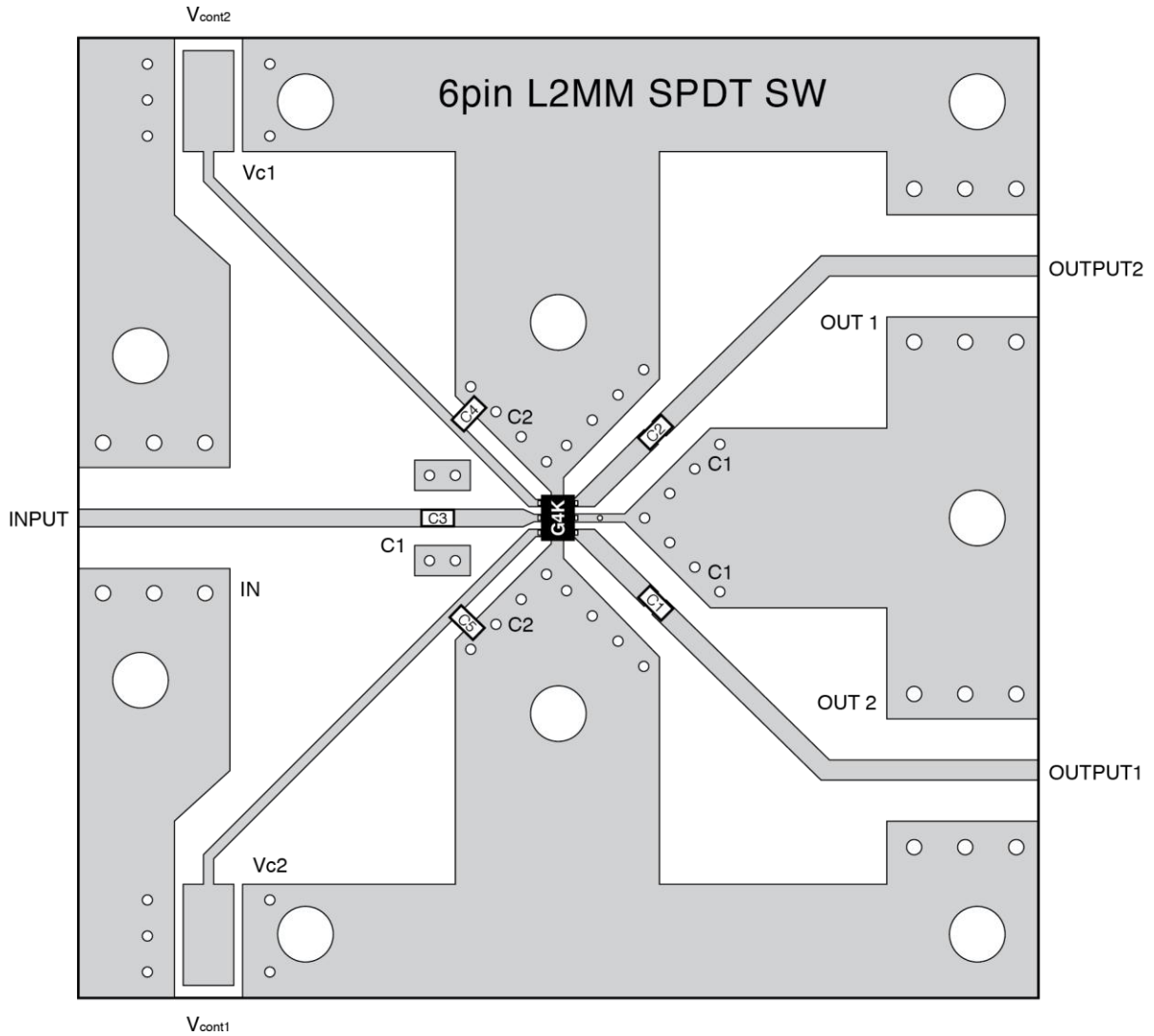

USING THE EVALUATION BOARD

Symbol	Values
C1, C2, C3	100 pF
C4, C5	1 000 pF

★ TYPICAL CHARACTERISTICS

( $T_A = +25^\circ\text{C}$ ,  $V_{\text{cont}}(\text{H}) = 3.0\text{ V}$ ,  $V_{\text{cont}}(\text{L}) = 0\text{ V}$ , DC cut capacitors = 100 pF, unless otherwise specified)

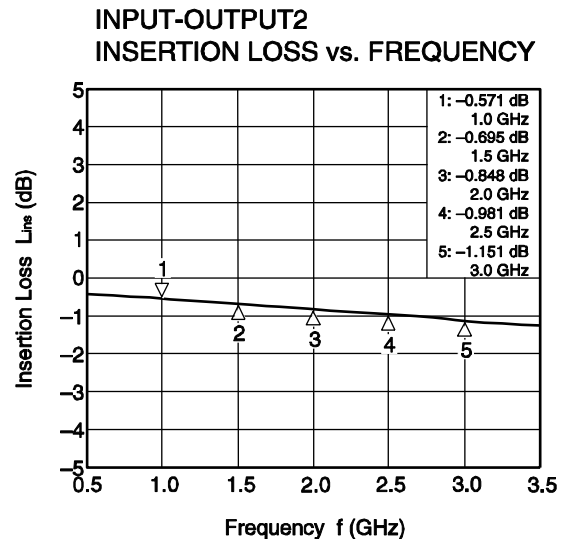
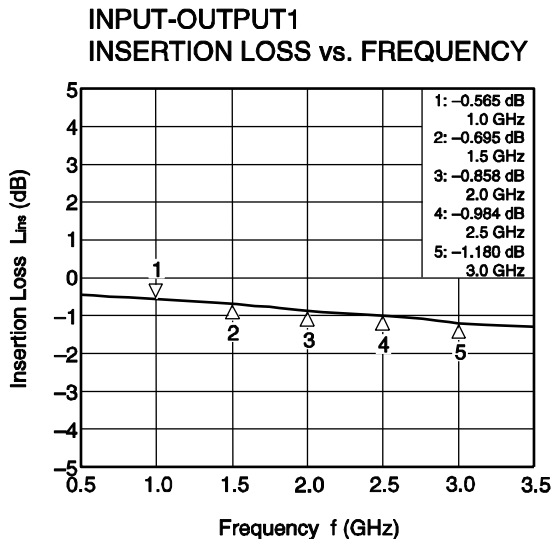

**Remark** The graphs indicate nominal characteristics.

**Caution** These characteristics values include the losses of the evaluation board.

**INPUT-OUTPUT1  
ISOLATION vs. FREQUENCY**

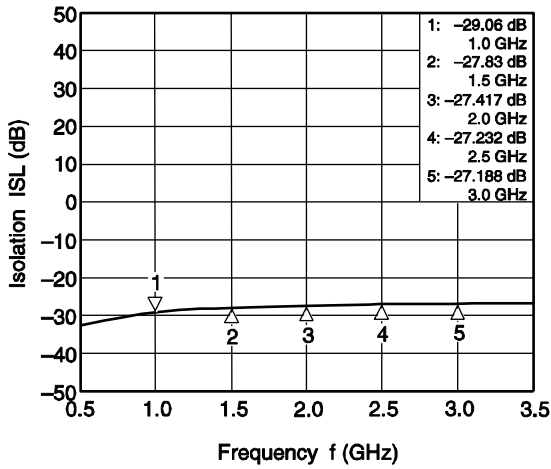

**INPUT-OUTPUT2  
ISOLATION vs. FREQUENCY**

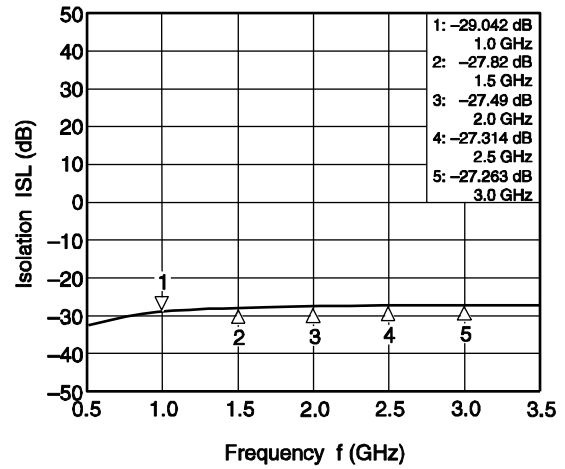

**INPUT-OUTPUT1  
INPUT RETURN LOSS vs. FREQUENCY**

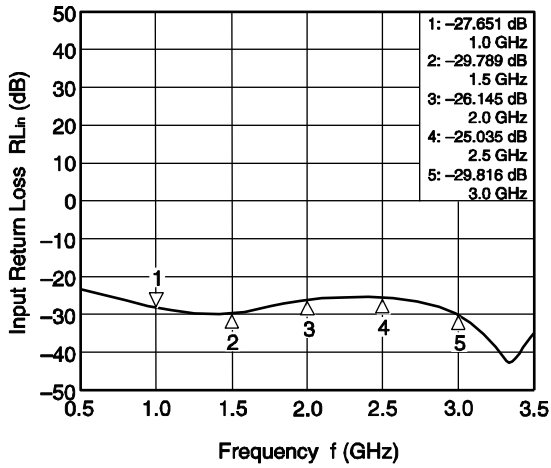

**INPUT-OUTPUT2  
INPUT RETURN LOSS vs. FREQUENCY**

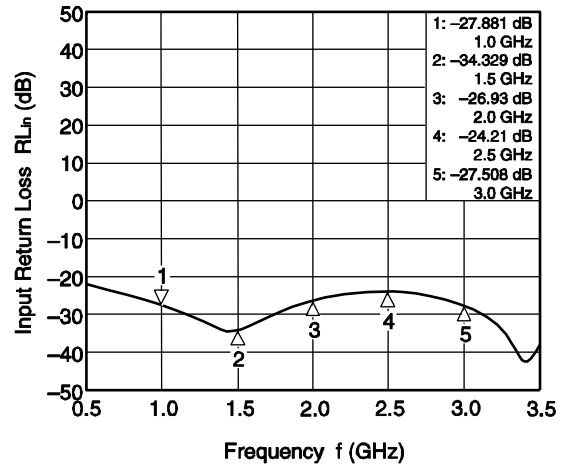

**INPUT-OUTPUT1  
OUTPUT RETURN LOSS vs. FREQUENCY**

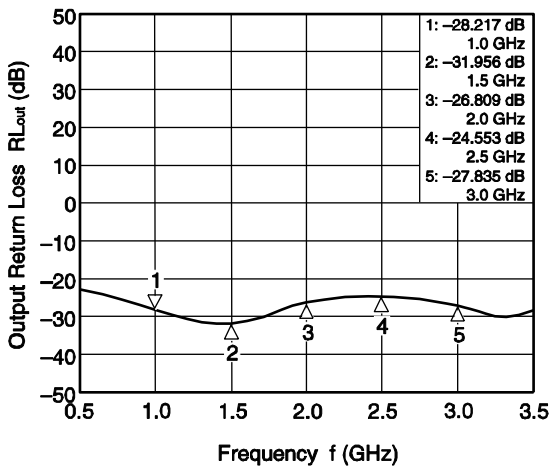

**INPUT-OUTPUT2  
OUTPUT RETURN LOSS vs. FREQUENCY**

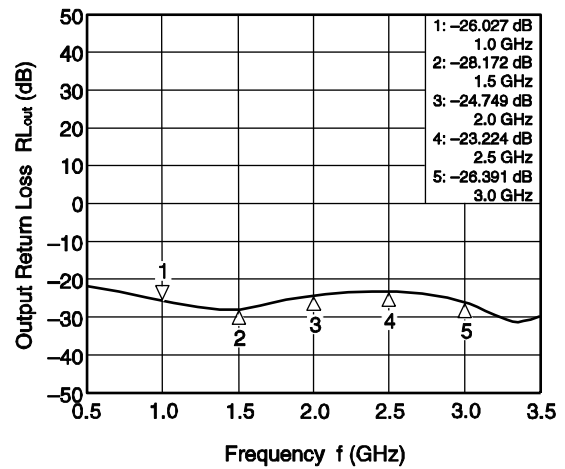

**Remark** The graphs indicate nominal characteristics.



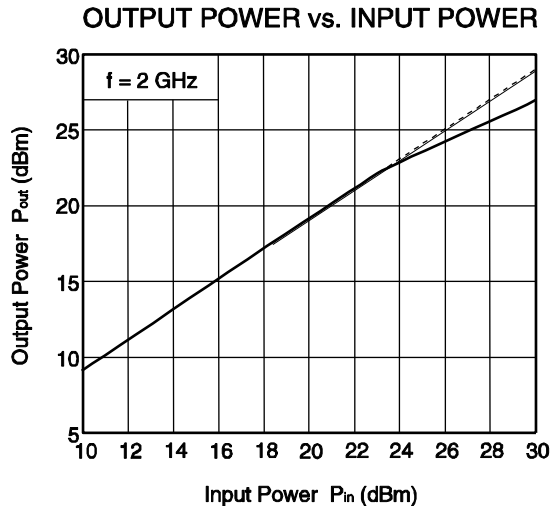

**Remark** The graph indicate nominal characteristics.

PACKAGE DIMENSIONS

6-PIN LEAD-LESS MINIMOLD (1511) (UNIT: mm)

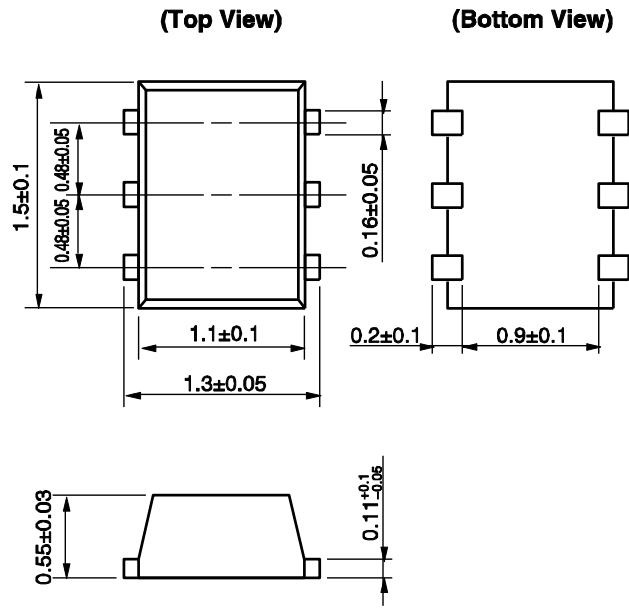

**RECOMMENDED SOLDERING CONDITIONS**

This product should be soldered and mounted under the following recommended conditions. For soldering methods and conditions other than those recommended below, contact your nearby sales office.

Soldering Method	Soldering Conditions	Condition Symbol
Infrared Reflow	Peak temperature (package surface temperature) : 260°C or below Time at peak temperature : 10 seconds or less Time at temperature of 220°C or higher : 60 seconds or less Preheating time at 120 to 180°C : 120±30 seconds Maximum number of reflow processes : 3 times Maximum chlorine content of rosin flux (% mass) : 0.2%(Wt.) or below	IR260
VPS	Peak temperature (package surface temperature) : 215°C or below Time at temperature of 200°C or higher : 25 to 40 seconds Preheating time at 120 to 150°C : 30 to 60 seconds Maximum number of reflow processes : 3 times Maximum chlorine content of rosin flux (% mass) : 0.2%(Wt.) or below	VP215
Wave Soldering	Peak temperature (molten solder temperature) : 260°C or below Time at peak temperature : 10 seconds or less Preheating temperature (package surface temperature) : 120°C or below Maximum number of flow processes : 1 time Maximum chlorine content of rosin flux (% mass) : 0.2%(Wt.) or below	WS260
Partial Heating	Peak temperature (pin temperature) : 350°C or below Soldering time (per side of device) : 3 seconds or less Maximum chlorine content of rosin flux (% mass) : 0.2%(Wt.) or below	HS350

**Caution Do not use different soldering methods together (except for partial heating).**

<p><b>Caution</b></p>	<p>GaAs Products</p>	<p>This product uses gallium arsenide (GaAs). GaAs vapor and powder are hazardous to human health if inhaled or ingested, so please observe the following points.</p> <ul style="list-style-type: none"> <li>• Follow related laws and ordinances when disposing of the product. If there are no applicable laws and/or ordinances, dispose of the product as recommended below.</li> </ul> <ol style="list-style-type: none"> <li>1. Commission a disposal company able to (with a license to) collect, transport and dispose of materials that contain arsenic and other such industrial waste materials.</li> <li>2. Exclude the product from general industrial waste and household garbage, and ensure that the product is controlled (as industrial waste subject to special control) up until final disposal.</li> </ol> <ul style="list-style-type: none"> <li>• Do not burn, destroy, cut, crush, or chemically dissolve the product.</li> <li>• Do not lick the product or in any way allow it to enter the mouth.</li> </ul>
-----------------------	----------------------	---