



VARITRONIX

VL-FS-MDLS40263-01 REV.C

(MDLS40263-HT-HV-F-LED03-YG-12-CON)

JUN/2006

PAGE 1 OF 25

DOCUMENT NUMBER AND REVISION
VL-FS-MDLS40263-01 REV.C
(MDLS40263-HT-HV-F-LED03-YG-12-CON)

DOCUMENT TITLE:
SPECIFICATION
OF
LCD MODULE TYPE
ITEM NO.: MDLS40263-01

DEPARTMENT	NAME	SIGNATURE	DATE
PREPARED BY	LINDA ZHU	Linda zhu	2006.6.17
CHECKED BY	FRANK WANG	王世强	2006.6.20
APPROVED BY	DERRICK TAM	Derrick	2006.6.20

DISTRIBUTION LIST: MARKETING



DOCUMENT REVISION HISTORY

DOCUMENT REVISION FROM TO	DATE	DESCRIPTION	CHANGED BY	CHECKED BY
0.0	2000.09.22	First Release	PHILIP CHENG	K.P.HO
0 A	2002.03.01	Items 1 to 4 were updated: (Based on the test specification VL-TS-MDLS40263-01 REV. A 2001.07.24). 1.)(Whole document) Number and format of pages were updated. 2.)(Page 1, Page 4) “Preliminary specification” was changed to “Specification”. 3.)(Page 8, point 4.2, table 5) Supply voltage (LCD), supply current (Logic & LCD) & supply current (LCD) were updated. 4.)(Page 12) Point 4.5 was added.	PHILIP CHENG	TOM LEE
A B	2004.02.04	Items 1 to 2 were updated: (Based on a.) Test specification VL-TS-MDLS40263-XX, REV. B, 2004.01.12). b.) VL-QUA-012B-S, REV. U, JUN/2003 (English version), According to VL-QUA-012B, LCD size is small because Unit Per Laminate=27 which is more than 6pcs/Laminate.) 1.)(Page 8, point 4.2, table 5) Supply current (Logic & LCD) & supply current (LCD) were updated. 2.) (Page 13, Point 5) LCD Cosmetic acceptance criteria was added.	HELEN HE	YU HAO
B C	2006.06.16	Items 1 to 7 were updated. Based on a.) Test Specification: VL-TS-MDLS40263-XX REV.F 2006.04.05 b.) VL-QUA-012B REV.W 2004.03.20. 1.) (Cover page and header) Module’s description was updated. 2.) (Page 4, Point 1) “RoHS” compliance was added. 3.) (Page 4, Table 1) Weight & outline dimension were added. 4.) (Page 5, Figure1) Module specification was updated. 5. (Page 8, Table 5) Wavelength & Luminance of yellow-green LED03 backlight were added. 6.) (Page 13, Point 5) Remark was added. 7.) (Page 14, Point 6) LCD cosmetic conditions was updated.	LINDA ZHU	FRANK WANG



CONTENTS

	<u>Page No.</u>
1. GENERAL DESCRIPTION	4
2. MECHANICAL SPECIFICATIONS	4
3. ABSOLUTE MAXIMUM RATINGS	6
3.1 ELECTRICAL MAXIMUM RATINGS-FOR IC ONLY	6
3.2 ENVIRONMENTAL CONDITION	6
4. ELECTRICAL SPECIFICATIONS	7
4.1 INTERFACE SIGNALS	7
4.2 TYPICAL ELECTRICAL CHARACTERISTICS	8
4.3 TIMING SPECIFICATIONS	9
4.4 TIMING DIAGRAM OF VDD AGAINST V0	11
4.5 CORRESPONDENCE BETWEEN CHARACTER CODES AND CHARACTER PATTERNS (NOVATEK STANDARD NT3881D-01)	12
5. REMARK	13
6. LCD COSMETIC CONDITIONS	14

VARITRONIX LIMITED

**Specification
 of
 LCD Module Type
 Item No.: MDLS40263-01**

1. General Description

- 40 characters (5x8 dots) x 2 lines FSTN HT2 Positive Black & White Transflective LCD Character Module.
- Viewing angle: 12 O'clock.
- Driving duty: 1/16 Duty, 1/4 bias.
- 'NOVATEK' NT3881DH-01/AI (die form) LCD Controller and Driver or equivalent.
- 'SAMSUNG' KS0065B-PCC (die form) LCD Segment/Common Driver or equivalent.
- Yellow-green LED03 backlight.
- Connector.
- "RoHS" compliant.

2. Mechanical Specifications

The mechanical detail is shown in Fig. 1 and summarized in Table 1 below.

Table 1

Parameter	Specifications	Unit
Outline dimensions	108.0(W) x 20.0(H) x 13.0 MAX.(D) (Exclude connector)	mm
Effective viewing area	89.0(W) x 10.0(H)	mm
Display format	40 characters x 2 lines	-
Character size	1.85(W) x 3.15(H) (5 x 8 dots)	mm
Character spacing	0.30(W) x 1.10(H)	mm
Character pitch	2.15(W) x 4.25(H)	mm
Dot size	0.33(W) x 0.35(H)	mm
Dot spacing	0.05(W) x 0.05(H)	mm
Dot pitch	0.38(W) x 0.38(H)	mm
Weight	Approx: 30	gram

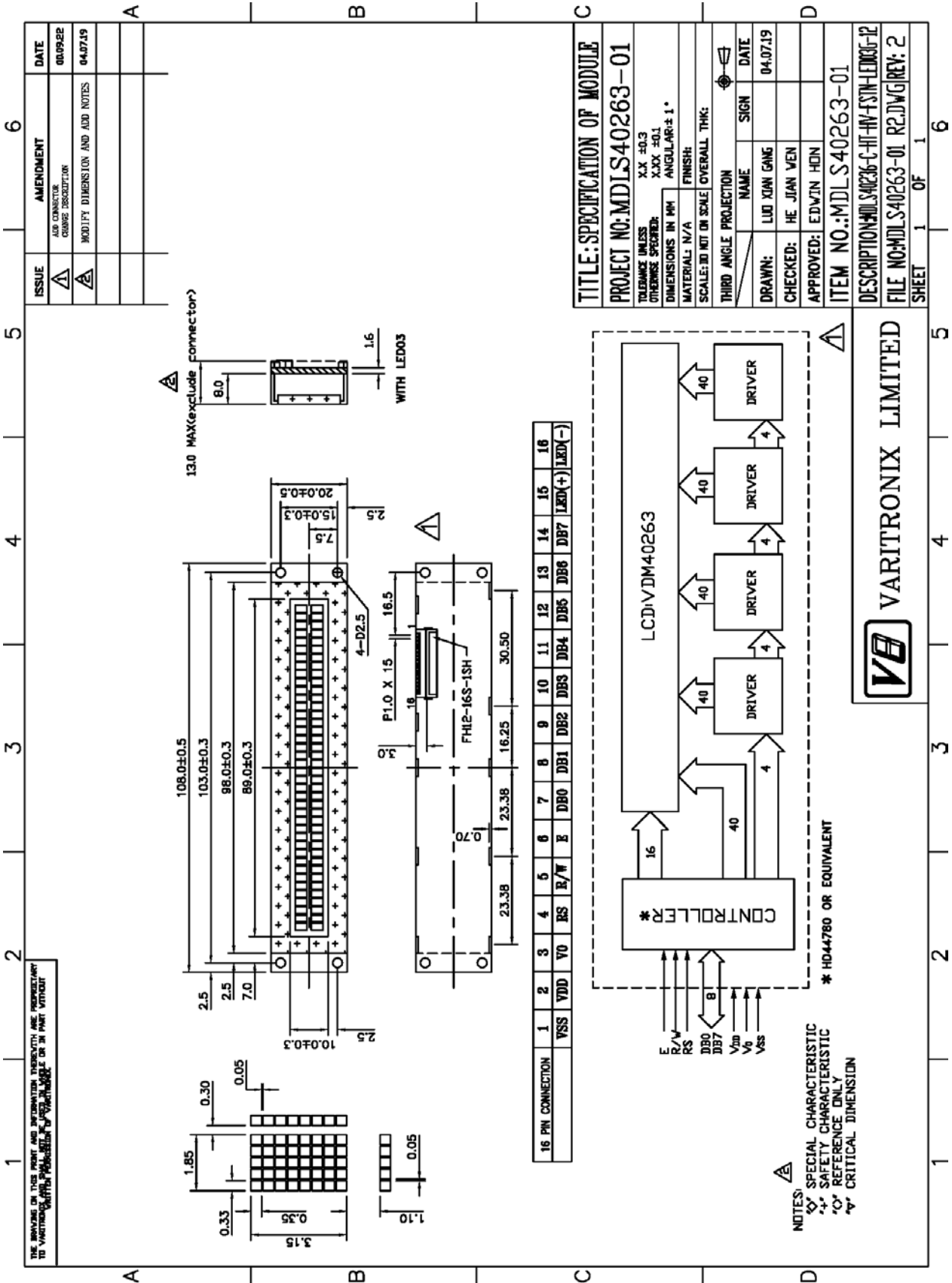

Figure 1: Module specification

3. Absolute Maximum Ratings

3.1 Electrical Maximum Ratings-for IC Only

Table 2

Parameter	Symbol	Min.	Max.	Unit
Power Supply voltage (Logic)	VDD - VSS	-0.3	+7.0	V
Power Supply voltage (LCD drive)	VLCD=VDD – V0	-0.3	+13.5	V
Input voltage	Vin	-0.3	VDD +0.3	V

Note:

The modules may be destroyed if they are used beyond the absolute maximum ratings.
 All voltage values are referenced to VSS = 0V.

3.2 Environmental Condition

Table 3

Item	Operating Temperature (Topr)		Storage Temperature (Tstg) (Note1)		Remark
	Min.	Max.	Min.	Max.	
Ambient Temperature	-20°C	+70°C	-30°C	+80°C	Dry
Humidity (Note1)	90% max. RH for Ta ≤ 40°C <50%RH for 40°C <Ta≤ Maximum operating temperature				No condensation
Vibration (IEC 68-2-6) cells must be mounted on a suitable connector	Frequency: 10 ~ 55 Hz Amplitude: 0.75 mm Duration: 20 cycles in each direction.				3 directions
Shock (IEC 68-2-27) Half-sine pulse shape	Pulse duration: 11 ms Peak acceleration: 981 m/s ² = 100g Number of shocks: 3 shocks in 3 mutually perpendicular axes.				3 directions

Note1: Product cannot sustain at extreme storage conditions for a long time.



4. Electrical Specifications

4.1 Interface signals

Table 4

Pin No.	Symbol	Description
1	VSS	Ground (0V).
2	VDD	Power supply for logic (+5V)
3	V0	Power supply for LCD driver
4	RS	Register Select Input: “High” for Data register (for read and write) “Low” for Instruction register (for write), Busy flag, address counter (for read)
5	R/W	Read/Write signal: “High” for Read mode. “Low” for Write mode.
6	E	Enable. Start signal for data read /write.
7	DB0	Data input/output (LSB)
8	DB1	Data input/output
9	DB2	Data input/output
10	DB3	Data input/output
11	DB4	Data input/output
12	DB5	Data input/output
13	DB6	Data input/output
14	DB7	Data input/output (MSB)
15	LED (+)	Anode of LED backlight
16	LED (-)	Cathode of LED backlight

4.2 Typical Electrical Characteristics

At Ta= 25 °C, VDD = 5V±5%, VSS=0V.

Table 5

Parameter	Symbol	Conditions	Min.	Typ.	Max.	Unit
Supply voltage (Logic)	VDD-VS		4.75	5.00	5.25	V
Supply voltage (LCD)	VLCD =VDD-V 0	VDD =5.0V, Note1.	8.1	8.6	9.1	V
Input signal voltage 1 for E,DB0-DB7,R/W,RS.	V _{IH1}	“H” level	2.2	-	VDD	V
	V _{IL1}	“L” level	-0.3	-	0.8	V
Input signal voltage 2 for OSC1.	V _{IH2}	“H” level	VDD -1.0	-	VDD	V
	V _{IL2}	“L” level	VSS	-	1.0	V
Supply Current (Logic & LCD)	IDD	Character mode, VDD =5.0V, Note 1	-	1.5	2.3	mA
		Checker board mode, VDD =5.0V,Note 1	-	1.8	2.7	mA
Supply Current (LCD)	I0	Character mode, VDD =5.0V, Note 1	-	0.5	0.7	mA
		Checker board mode, VDD =5.0V,Note 1	-	0.5	0.7	mA
Supply Voltage of yellow-green LED03 backlight	VLED03	Forward current =255mA	3.9	4.1	4.3	V
Wavelength of yellow-green LED03 backlight	λ	Number of LED dies =34.	-	568	-	nm
Luminance of backlight (on the backlight surface)			-	76	-	cd/m ²

Note 1: There is tolerance in optimum LCD driving voltage during production and it will be within the specified range.



4.3 Timing Specifications

At $T_a = -20\text{ }^{\circ}\text{C}$ To $+70\text{ }^{\circ}\text{C}$, $V_{DD} = +5\text{V} \pm 5\%$, $V_{SS} = 0\text{V}$.

Refer to Fig. 2, the bus timing diagram for write mode.

Table 6

Parameter	Symbol	Min.	Max.	Unit	Remarks
Enable cycle time	t_{CYCE}	500	-	ns	
Enable "High" level pulse width	t_{WHE}	300	-	ns	
Enable rise time	t_{RE}	-	25	ns	
Enable fall time	t_{FE}	-	25	ns	
RS, R/W set-up time	t_{AS}	60	-	ns	8-bit operation mode
		100			4-bit operation mode
RS, R/W address hold time	t_{AH}	10	-	ns	
Data output delay	t_{DS}	100	-	ns	
Data hold time	t_{DHR}	10	-	ns	

Refer to Fig. 3, the bus timing diagram for read mode.

Table 7

Parameter	Symbol	Min.	Max.	Unit	Remarks
Enable cycle time	t_{CYCE}	500	-	ns	
Enable "High" level pulse width	t_{WHE}	300	-	ns	
Enable rise time	t_{RE}	-	25	ns	
Enable fall time	t_{FE}	-	25	ns	
RS, R/W set-up time	t_{AS}	60	-	ns	8-bit operation mode
		100			4-bit operation mode
RS, R/W address hold time	t_{AH}	10	-	ns	
Read data output delay	t_{RD}	-	190	ns	
Read data hold time	t_{DHR}	20	-	ns	

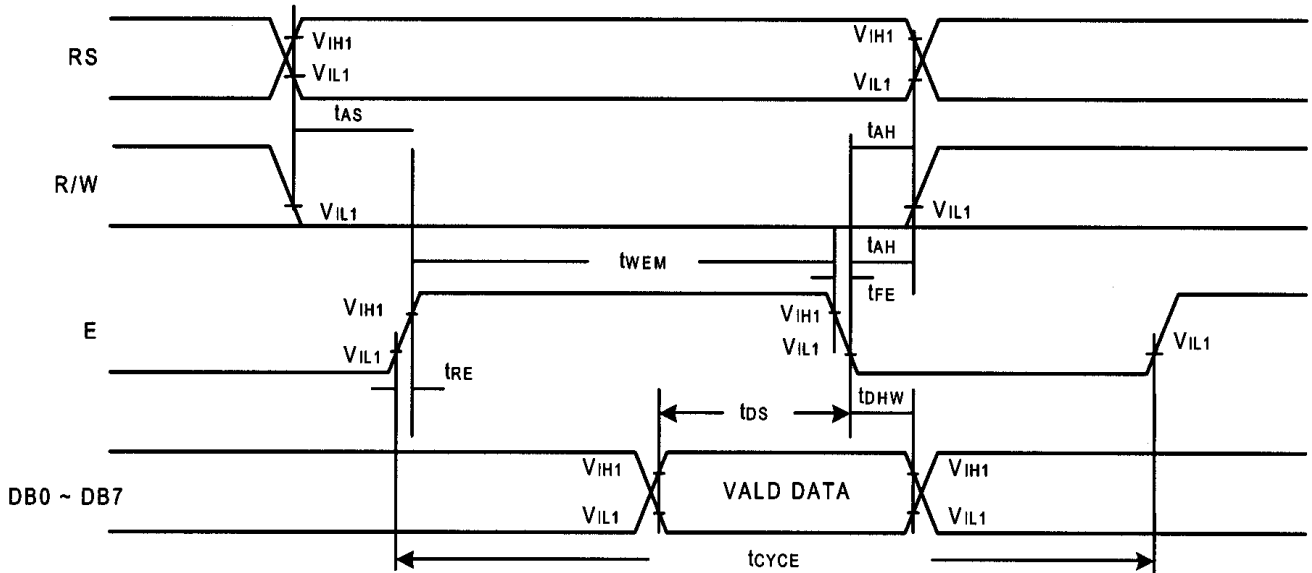

Figure 2: Bus write operation sequence (Writing data from MPU to NT3881).

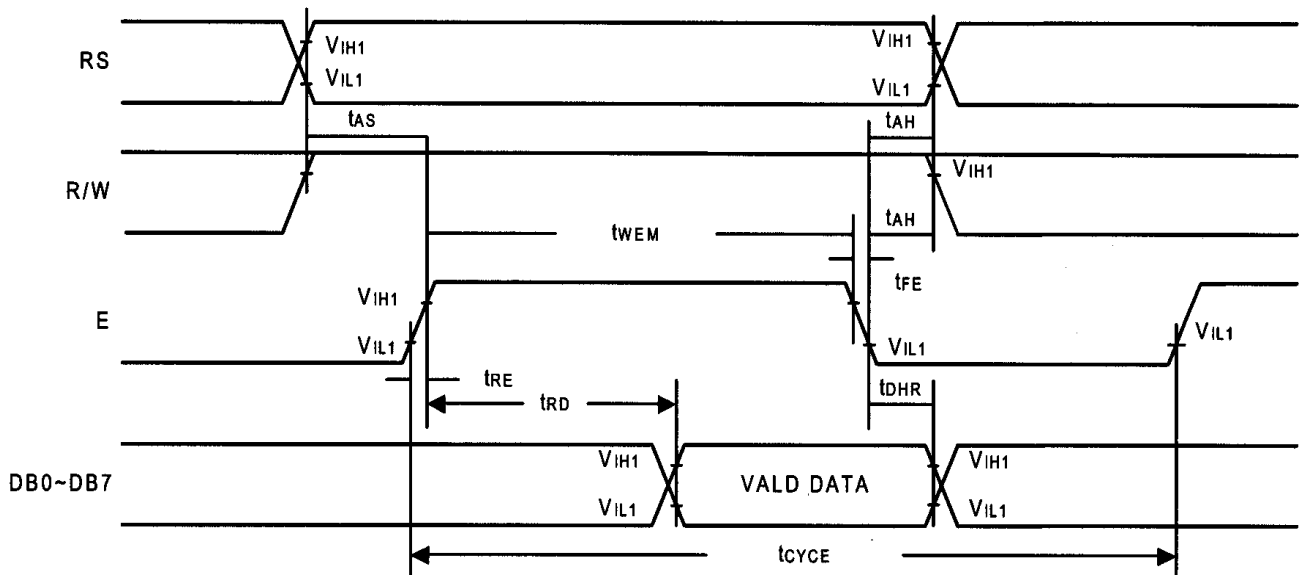

Figure 3: Bus read operation sequence (Reading out data from NT3881 to MPU).

4.4 Timing Diagram of VDD against V0.

Power on sequence shall meet the requirement of Figure 4, the timing diagram of VDD against V0.

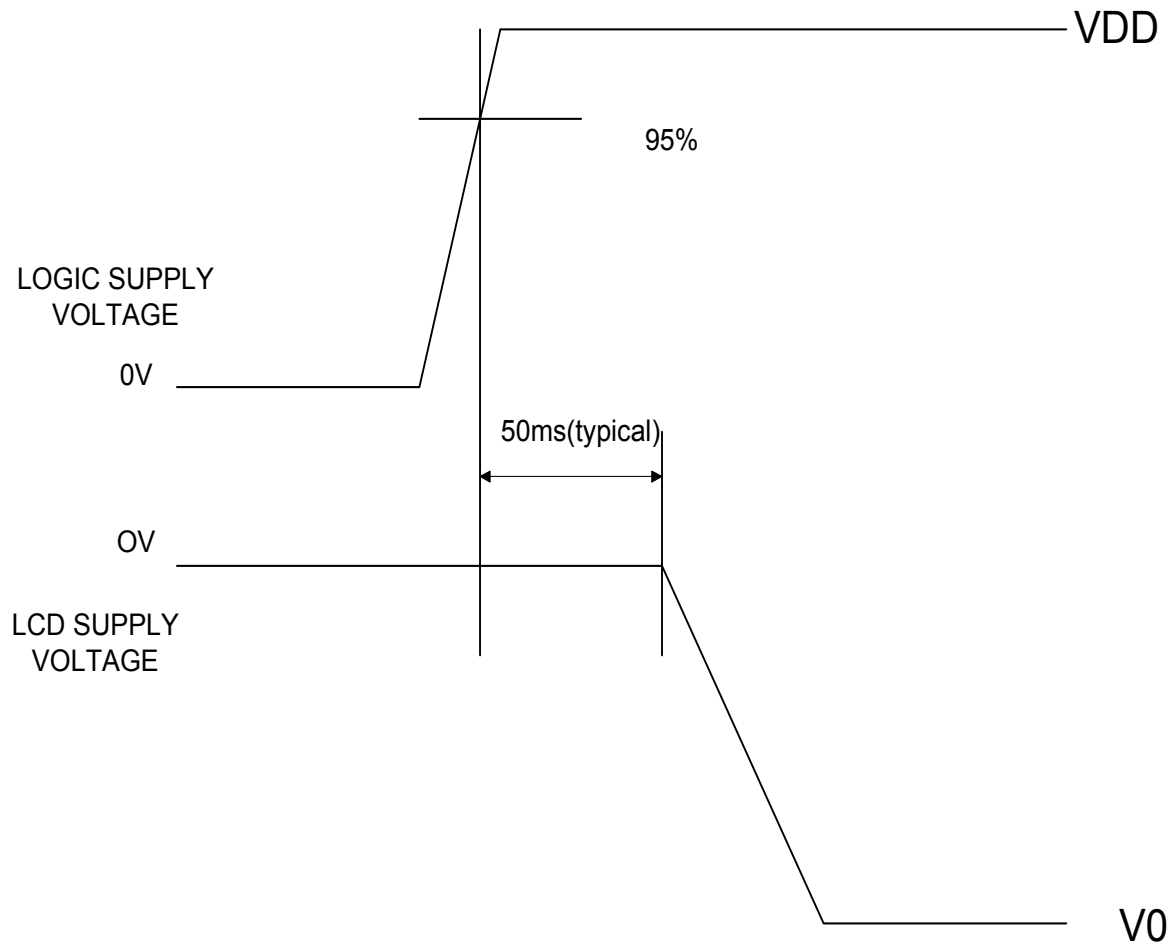

Figure 4: Timing diagram of VDD against V0.

4.5 Correspondence between Character Codes and Character Patterns
 (NOVATEK Standard NT3881D-01)

		Higher 4-bit (D4 to D7) of Character Code (Hexadecimal)																
		0	1	2	3	4	5	6	7	8	9	A	B	C	D	E	F	
Lower 4-bit (D0 to D3) of Character Code (Hexadecimal)	0	CG RAM (1)			0	a	P	`	P					一	夕	三	α	P
	1	CG RAM (2)		!	1	A	Q	a	9			。	ア	チ	4	ä	9	
	2	CG RAM (3)		"	2	B	R	b	r			「	イ	ツ	×	ß	θ	
	3	CG RAM (4)		#	3	C	S	c	s			」	ウ	テ	〒	ε	ω	
	4	CG RAM (5)		\$	4	D	T	d	t			、	エ	ト	ト	μ	Ω	
	5	CG RAM (6)		%	5	E	U	e	u			、	オ	ナ	1	ü	ü	
	6	CG RAM (7)		&	6	F	V	f	v			ヲ	カ	ニ	ヨ	ρ	Σ	
	7	CG RAM (8)		'	7	G	W	g	w			フ	キ	ヌ	ラ	9	π	
	8	CG RAM (1)		(8	H	X	h	x			イ	ク	ネ	リ	γ	×	
	9	CG RAM (2))	9	I	Y	i	y			ウ	ケ	ル	ル	-	γ	
	A	CG RAM (3)		*	:	J	Z	j	z			エ	コ	ン	ル	j	〒	
	B	CG RAM (4)		+	;	K	Ç	k	ç			オ	サ	ヒ	ロ	*	π	
	C	CG RAM (5)		,	<	L	¥	l	l			ト	シ	フ	フ	φ	π	
	D	CG RAM (6)		-	=	M	ı	m	ı			ユ	ズ	ゝ	ン	ト	÷	
	E	CG RAM (7)		.	>	N	^	n	→			ヨ	セ	ホ	ゝ	ñ		
	F	CG RAM (8)		/	?	O	_	o	+			ッ	リ	マ	°	ö		



5. Remark

HANDLING LCD AND LCD MODULES

1. Liquid Crystal Display (LCD)

LCD is made up of glass, organic sealant, organic fluid and polymer based polarizers. The following precautions should be taken when handling:

- (1) Keep the temperature within range for use and storage. Excessive temperature and humidity could cause polarization degradation, polarizer peel-off or bubble generation. When storage for a long period over 40° C is required, the relative humidity should be kept below 60%.
- (2) Do not contact the exposed polarizers with anything harder than an HB pencil lead. To clean dust off the display surface, wipe gently with cotton, chamois or other soft material soaked in petroleum benzin. Never scrub hard.
- (3) Varitronix does not responsible for any polarizer defect after the protective film has been removed from the display
- (4) Wipe off saliva or water drops immediately. Contact with water over a long period of time may cause polarizer deformation or color fading, while an active LCD with water condensation on its surface will cause corrosion of ITO electrodes.
- (5) PETROLEUM BENZIN is recommended to remove adhesives used to attach front/rear polarizers and reflectors, while chemicals like acetone, toluene, ethanol and isopropyl alcohol will cause damage to the polarizer. Avoid oil and fats. Avoid lacquer and epoxies which might contain solvents and hardeners to cause electrode erosion. Some solvents will also soften the epoxy covering the DIL pins and thereby weakening the adhesion of the epoxy on glass. This will cause the exposed electrodes to erode electrochemically when operating in high humidity and condensing environment.
- (6) Glass can be easily chipped or cracked from rough handling, especially at corners and edges.
- (7) Do not drive LCD with DC voltage.
- (8) When soldering DIL pins, avoid excessive heat and keep soldering temperature between 260°C to 300°C for no more than 5 seconds. Never use wave or reflow soldering.

2. Liquid Crystal Display Modules (MDL)

2.1 Mechanical Considerations

MDL's are assembled and adjusted with a high degree of precision. Avoid excessive shocks and do not make any alterations or modifications. The following should be noted.

- (1) Do not tamper in any way with the tabs on the metal frame.
- (2) Do not modify the PCB by drilling extra holes, changing its outline, moving its components or modifying its pattern.
- (3) Do not touch the elastomer connector (conductive rubber), especially when inserting an EL panel.

- (4) When mounting a MDL make sure that the PCB is not under any stress such as bending or twisting. Elastomer contacts are very delicate and missing pixels could result from slight dislocation of any of the elements.
- (5) Avoid pressing on the metal bezel, otherwise the elastomer connector could be deformed and lose contact, resulting in missing pixels.
- (6) If FPCA need to be bent, please refer the suggested bending area on the specification. The stiffener and component area on FPC/FFC/COF must not be bent during or after assembly (Note: for those models with FPC/FFC/COF +stiffener).
- (7) Sharp bending should be avoided on FPC to prevent track cracking.

2.2 Static Electricity

MDL contains CMOS LSI's and the same precaution for such devices should apply, namely:

- (1) The operator should be grounded whenever he comes into contact with the module. Never touch any of the conductive parts such as the LSI pads, the copper leads on the PCB and the interface terminals with any part of the human body.
- (2) The modules should be kept in antistatic bags or other containers resistant to static for storage.
- (3) Only properly grounded soldering irons should be used.
- (4) If an electric screwdriver is used it should be well grounded and shielded from commutator sparks.
- (5) The normal static prevention measures should be observed for work clothes and working benches; for the latter conductive (rubber) mat is recommended.
- (6) Since dry air is inductive to statics, a relative humidity of 50 - 60% is recommended.

2.3 Soldering

- (1) Solder only to the I/O terminals.
- (2) Use only soldering irons with proper grounding and no leakage.
- (3) Soldering temperature is 280°C ± 10°C .
- (4) Soldering time: 3 to 4 seconds.
- (5) Use eutectic solder with resin flux fill.
- (6) If flux is used, the LCD surface should be covered to avoid flux spatters. Flux residue should be removed afterwards.
- (7) Use proper de-soldering methods (e.g. suction type desoldering irons) to remove lead wires from the I/O terminals when necessary. Do not repeat the soldering/ desoldering process more than three times as the pads and plated through holes may be damaged.

2.4 Label

Identification labels will be stuck on the module without

obstructing the viewing area of display.

3. Operation

- (1) The viewing angle can be adjusted by varying the LCD driving voltage V_0 .
- (2) Driving voltage should be kept within specified range, excess voltage shortens display life.
- (3) Response time increases with decrease in temperature.
- (4) Display may turn black or dark Blue at temperatures above its operational range; this is however not destructive and the display will return to normal once the temperature falls back to range.
- (5) Mechanical disturbance during operation (such as pressing on the viewing area) may cause the segments to appear "fractured". They will recover once the display is turned off.
- (6) Condensation at terminals will cause malfunction and possible electrochemical reaction. Relative humidity of the environment should therefore be kept below 60%.
- (7) Display performance may vary out of viewing area. If there is any special requirement on performance out of viewing area, please consult Varitronix.

4. Storage and Reliability

- (1) LCD's should be kept in sealed polyethylene bags while MDL's should use antistatic ones. If properly sealed, there is no need for desiccant.
- (2) Store in dark places and do not expose to sunlight or fluorescent light. Keep the temperature between 0°C and 35°C and the relative humidity low. Please consult VARITRONIX for other storage requirements.
- (3) Water condensation will affect reliability performance of the display and is not allowed.
- (4) Semi-conductor device on the display is sensitive to light and should be protected properly.
- (5) Power up/down sequence.
 - a) Power Up: in general, LCD supply voltage, V_0 must be supplied after logic voltage, VDD becomes steady. Please refer to related IC data sheet for details.
 - b) Power Down: in general, LCD supply voltage, V_0 must be removed before logic voltage, VDD turns off. Please refer to related IC data sheet for details.

5. Safety

If any fluid leaks out of a damaged glass cell, wash off any human part that comes into contact with soap and water. Never swallow the fluid. The toxicity is extremely low but caution should be exercised at all times.

LIMITED WARRANTY

VARITRONIX LCDs and modules are not consumer products, but may be incorporated by VARITRONIX's customers into consumer products or components thereof. VARITRONIX does not warrant that its LCDs and components are fit for any such particular purpose.

1. The liability of VARITRONIX is limited to repair or replacement on the terms set forth below. VARITRONIX will not be responsible for any subsequent or consequential events or injury or damage to any personnel or user including third party personnel and/or user.

Unless otherwise agreed in writing between VARITRONIX and the customer, VARITRONIX will only replace or repair any of its LCD which is found defective electrically or visually when inspected in

accordance with VARITRONIX LCD Acceptance Standards (copies available on request), for a period of one year from the date of shipment. Confirmation of such date shall be based on freight documents.

2. No warranty can be granted if any of the precautions stated in HANDLING LCD and LCD Modules above have been disregarded. Broken glass, scratches on polarizers, mechanical damages as well as defects that are caused by accelerated environmental tests are excluded from warranty.
3. In returning the LCD and Modules, they must be properly packaged and there should be detailed description of the failures or defects.

IMPORTANT NOTICE

The information presented in this document has been carefully checked and is believed to be accurate, however, no responsibility is assumed for inaccuracies. VARITRONIX reserves the right to make changes to any specifications without further notice for performance, reliability, production technique and other considerations. VARITRONIX does not assume any liability arising out of the application or use of products herein. Please see Limited Warranty in the previous section.

6. LCD Cosmetic Conditions

- a.) Reference document follow VL-QUA-012B.
- b.) LCD size of the product is small.

- 6.1.TITLE: Final QA Inspection for Industrial LCD Products (G2)
- 6.2.Purpose: To define the final QA sampling inspection procedures and criteria for industrial grade LCD.
- 6.3.Scipe: This document applies to mass production of all industrial grade LCD after electrical test and before polarizer sticking process, LCD final inspection and ready for final QA sampling inspection, except of those with special requirement from customer.
- 6.4.Definition:
 - 6.4.1 ZONE A: EAA: Effective Active Area
 - ZONE B: EVA/VA: Viewing Area
 - ZONE C: Outside EVA
 - 6.4.2 Size: Large size (L): 1pcs/Laminate; Middle size (M): 2-6pcs/Laminate; Small size (S): >6pcs/Laminate.
- 6.5. Reference Document:
 - 6.5.1 VL-QUA-084A
 - 6.5.2 EI-WKL-980821-01
 - 6.5.3 EI-LT-980225-01
- 6.6. Applicable Equipment:
 - 6.6.1LCD Tester
- 6.7. Procedure
 - 6.7.1 Definition of LCD parts:

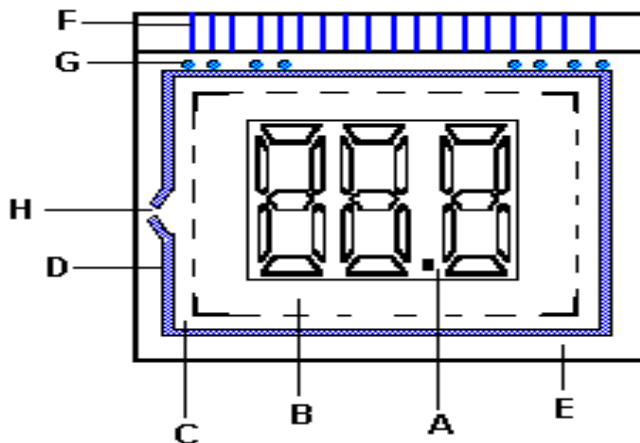

- A : Effective Activated Area
- B : Viewing Area
- C : Outside V.A.
- D : Perimeter Seal
- E : Out Perimeter Seal
- F : Contact Leads
- G : Silver Dot
- H : End Seal



6.7.2 Unless specified, LCD background color shall refer to standard color sample.

6.7.3 Inspection Specification:

6.7.3.1 Patterned glass inspection criterion:

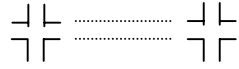
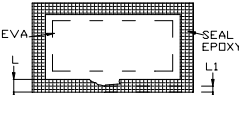
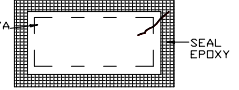
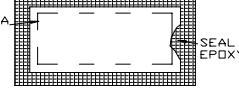
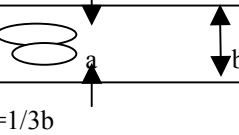
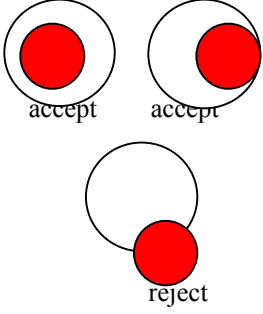

Defect Category	Defect Description	Scope	Criterion	Drawing Specification
Short	Photo-resist coated pattern connected	Patterned area	Not accept	
Open	Photo-resist coated pattern disconnected	Patterned area	Not accept	
Misalignment	Fish eyes misaligned	N/A	Not accept	
Pinhole	Pinhole on Photo-resist coating under sodium lamp	Patterned area	Not accept pinhole under sodium lamp with naked eyes	
Excess pattern	Excess Photo-resist	Patterned area	Not accept	
Missing pattern	Incomplete photo-resist	Patterned area	Not accept	
Rainbow	Uneven coating	ITO surface	Not accept colorific defect under sodium with naked eyes	
Black spot	Contaminated by foreign materials	Patterned area	Not accept foreign material under sodium lamp with unaided eyes	
Scratch	Scratch on glass surface	Patterned area	Not accept scratch on E.A.A	
Chip	Mechanical damage on glass edge or corner	Patterned area	Not accept damage on E.A.A	

6.7.3.2 Sodium Lamp Inspection Criteria

Defect Category	Defect Description	Zone	Criterion	Drawing Specification
Black spot/Foreign Materials	Foreign Material inside LC box	A, B, C, D	Newton Ring can't be found with unaided eyes under sodium lamp.	
Scratch	Scratch on glass surface	A, B, C, D	Scratch on EVA is not acceptable when it is observed under dark background with unaided eyes.	
Sealing problem	Sealing broken	D	Not accept	
	Wider sealing width	D	Sealing exceed scribing line is not accept. Refer to the drawing, sealing should not bleed into where between the two broken lines.	
	Narrow sealing width	D	Seal width narrowed to less than 2/3 of the normal width wherever on the display is not accepted. $L1 < 2/3 L$: reject	
	Distinct hairs going into the EVA through perimeter seal	D	Not accept	
	Seal epoxy bleeds into the EVA	D	Not accept	
	Bubble inside epoxy	D	Bubble diameter should $\leq 1/3$ seal width $a \leq 1/3b$	
Bag broken	Vacuum bag broken	N/A	Reject when bag broken at STN or Self-short DOT type. No requirement for TN/HTN or silver dot type.	
Misalignment	Top & bottom fish eyes misaligned	N/A	Dot and circle shall not intersect.	

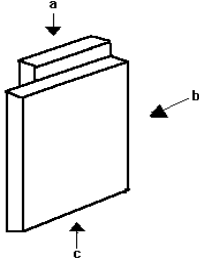
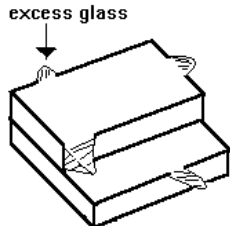
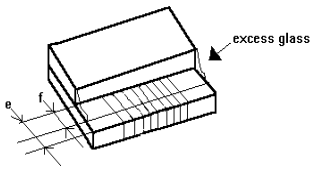
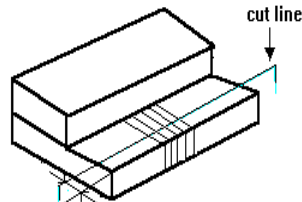
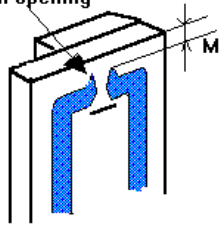
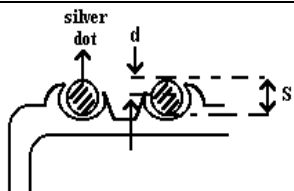
6.7.3.3 Criteria for Inspection after LC Filling:

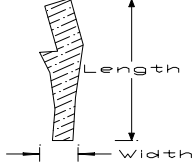
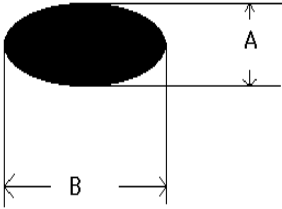
Defect Category	Defect Description	Zone	Criterion	Drawing Specification
Scribing defect	anomalous shape is observed on the edge viewing from direction a, b and c.	F, E	Shape shall be accordant with specification.	
	Excess glass within mechanical dimension.	F, E	Rework to remove the excess glass if possible.	
	Excess glass on contact lead	F	Accept if width of excess glass < 1/10 width of electrical contact area $f < 1/10 e$	 e = width of electrical contact area. f = width of excess glass.
	Scribing on contact leads	F	Cut line shall be according to specification	
	Wrong scribing	E	Accept if $M \leq 0\text{mm}$; M= distance between glass edge and seal opening;	
	Silver dot exposed	F, E	Acceptable if depth of exposure < 1/10 silver dot diameter $d < 1/10S$	

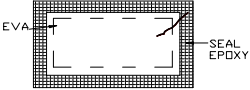
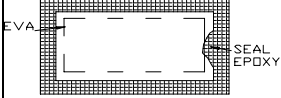
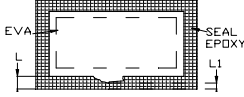
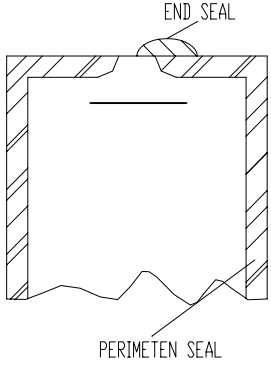
Defect Category	Defect Description	Zone	Criterion	Drawing Specification	
Scratches	Scratches on glass surface	A, B	Length (mm) Width (mm) Acc No.		
			/		<0.02
			Any		<0.03
			2		<0.05
			1		>0.05
0					
Bubble	LC does not fulfill the box	A, B	(a) One or more bubble with D exceeds 0.2mm in diameter within EVA.	 $D = (A+B)/2$	
			(b) Two or more bubbles with D 0.1mm to 0.2mm within the EVA.		
		A, B, C, H	(c) LCD is not accept if any bubble observed due to leakage of perimeter seal or end seal.		
Sealing Defect	White or color marks along the perimeter seal.	D	Not accept		
	Distinct hairs going into the EVA through the perimeter seal	A, B, C, D	Not accept		
	Seal epoxy bleeds into the EVA.	A, B, C, D	Not accept		
	Narrow seal width	D	Seal width narrowed to less than 2/3 normal width at any point of the display. L1 < 2/3 L: Reject		
	Color or hazy appearance neighboring to the end seal	H	Not accept		
	End seal epoxy does not entirely cover LC filling window.	H	Not accept		
	End seal depth exceed limit	H	Depth \geq 0.2mm and shall not go into V.A.		

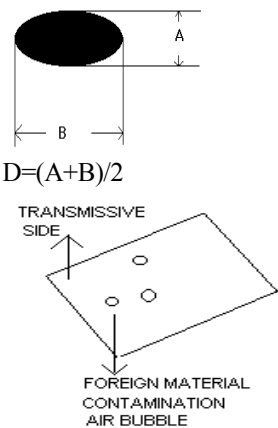
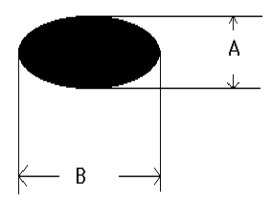
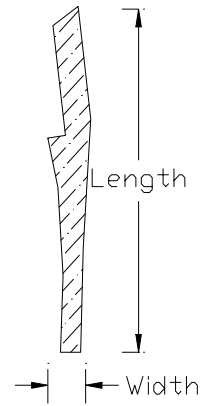
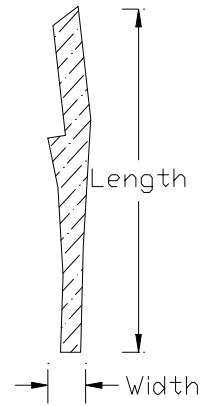
Defect Category	Defect Description	Zone	Criterion	Drawing Specification															
Black spot/ Foreign Materials	Black spot, Foreign materials, Polarizer bubble, dent.	A	<p><u>Large size glass:</u> Cosmetic defect can't be found at one meter distance to inspection and will not increase its size under electrical test.</p> <p><u>Middle size glass:</u> Diameter(mm) <u>Acc No.</u> $D \leq 0.1$ Any $0.10 < D \leq 0.20$ 2 $0.20 < D \leq 0.30$ 1 $0.30 < D$ 0</p> <p><u>Small size glass:</u> Diameter(mm) <u>Acc No.</u> $D \leq 0.10$ Any $0.10 < D \leq 0.20$ 1 $D > 0.20$ 0</p>																
		B	1.5 times of acceptable largest diameter size of Zone A																
		C	Accept any quantity and size except voids and reverse twist. But the reverse twist can be accept if it happened in zone c without PI coat.																
White spot(for -ve mode)		A	<p><u>Large size:</u> Diameter (mm) <u>Acc No.</u> $D < 0.1$ Any $0.1 < D \leq 0.15$ 3 $0.15 < D \leq 0.25$ 1 $0.25 < D$ 0</p> <p><u>Middle size:</u> Diameter (mm) <u>Acc No.</u> $D < 0.1$ Any $0.1 < D \leq 0.15$ 1 $0.15 < D$ 0</p> <p><u>Small size:</u> Diameter (mm) <u>Acc No.</u> $D < 0.1$ Any $0.1 < D$ 0</p>																
		B	1.5 times of acceptable largest diameter size of Zone A																
		C	Accept any quantity and size except voids and reverse twist. But the reverse twist can be accept if it happened in zone c without PI coat.																
Lines, hairs		A,	<table border="1"> <thead> <tr> <th>Length(mm)</th> <th>Width(mm)</th> <th>Acc No.(/cm2)</th> </tr> </thead> <tbody> <tr> <td>Any length</td> <td>≤ 0.01</td> <td>Any</td> </tr> <tr> <td>≤ 2.0</td> <td>≤ 0.02</td> <td>2</td> </tr> <tr> <td>≤ 3.0</td> <td>≤ 0.03</td> <td>1</td> </tr> <tr> <td>Any length</td> <td>> 0.03</td> <td>0</td> </tr> </tbody> </table> <p>(Applicable to all glasses with different area)</p>	Length(mm)	Width(mm)	Acc No.(/cm2)	Any length	≤ 0.01	Any	≤ 2.0	≤ 0.02	2	≤ 3.0	≤ 0.03	1	Any length	> 0.03	0	
		Length(mm)	Width(mm)	Acc No.(/cm2)															
		Any length	≤ 0.01	Any															
≤ 2.0	≤ 0.02	2																	
≤ 3.0	≤ 0.03	1																	
Any length	> 0.03	0																	
B	1.5 times of acceptable largest diameter size of Zone A																		
C	Accept any quantity and size except voids and reverse twist. But the reverse twist can be accept if it happened in zone c without PI coat.																		
Lines, hairs(for-ve model)		A	<table border="1"> <thead> <tr> <th>Length(mm)</th> <th>Width(mm)</th> <th>Acc No(/cm2)</th> </tr> </thead> <tbody> <tr> <td>Any length</td> <td>≤ 0.01</td> <td>Any</td> </tr> <tr> <td>≤ 2.0</td> <td>≤ 0.02</td> <td>1</td> </tr> <tr> <td>Any length</td> <td>> 0.02</td> <td>0</td> </tr> </tbody> </table>	Length(mm)	Width(mm)	Acc No(/cm2)	Any length	≤ 0.01	Any	≤ 2.0	≤ 0.02	1	Any length	> 0.02	0				
		Length(mm)	Width(mm)	Acc No(/cm2)															
		Any length	≤ 0.01	Any															
≤ 2.0	≤ 0.02	1																	
Any length	> 0.02	0																	
B	<table border="1"> <thead> <tr> <th>Length(mm)</th> <th>Width(mm)</th> <th>Acc No(/cm2)</th> </tr> </thead> <tbody> <tr> <td>Any length</td> <td>≤ 0.01</td> <td>Any</td> </tr> <tr> <td>≤ 3.0</td> <td>≤ 0.02</td> <td>1</td> </tr> <tr> <td>Any length</td> <td>> 0.02</td> <td>0</td> </tr> </tbody> </table>	Length(mm)	Width(mm)	Acc No(/cm2)	Any length	≤ 0.01	Any	≤ 3.0	≤ 0.02	1	Any length	> 0.02	0						
Length(mm)	Width(mm)	Acc No(/cm2)																	
Any length	≤ 0.01	Any																	
≤ 3.0	≤ 0.02	1																	
Any length	> 0.02	0																	
C	Accept any quantity and size except voids and reverse twist. But the reverse twist can be accept if it happened in zone c without PI coat.																		

Remark: 1. All above black spot/ foreign material defects min. space shall be $\geq 20\text{mm}$ ◦

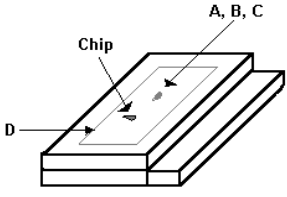
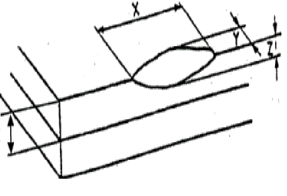
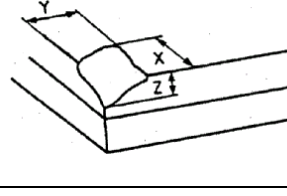
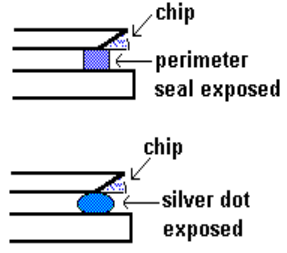
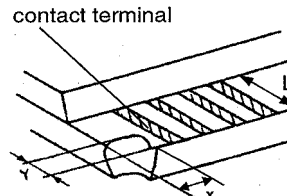
Defect Category	Defect Description	Zone	Criterion	Drawing Specification
Rainbow	Arches, circular or parallel colorful spread observed	A, B	Refer to golden sample	
Fingerprint	Fingerprint on PI coating	A, B	Not accept any fingerprint	
PI scrape	PI scraped	A, B	Refer to above Black spot/ Foreign Materials criterion	
Reverse twist	Visible radialized spot	A, B, C	Not accept	
Mechanical Damage	Chip on surface/ side/ corner/ perimeter seal/ silver dot	A, B, C	Not accept any chip	
		D, E	When $Z < 3/4$ glass thickness 1- $X \leq 3\text{mm}$; 2- $Y \leq 1/2$ perimeter seal width. When $Z \geq 3/4$ glass thickness 2- $X \leq 2\text{mm}$; 3- $Y < 1/3$ perimeter seal width.. Note: If glass thickness $< 0.7\text{mm}$, accept $Z = \text{glass thickness}$	
			Same as above spec.	
		D, G	1- The silver dot can not be exposed. 2- more than 50% of sealing frame must remain,	
	Chips on ledge, but not on ITO trace	F	When $Z < 1/2$ glass thickness: 1- $X \leq 5\text{mm}$; 2- $Y \leq$ length of ledge When $Z \geq 1/2$ glass thickness: 1- $X \leq 2\text{mm}$; 2- $Y \leq 1/2$ length of ledge. Note: If glass thickness $< 0.7\text{mm}$, accept $Z = \text{glass thickness}$	

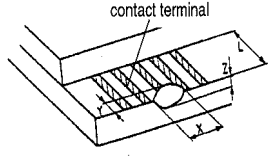
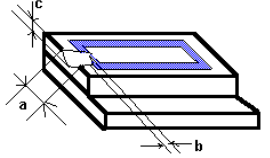
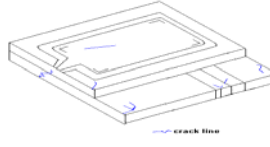
Defect Category	Defect Description	Zone	Criterion	Drawing Specification
Mechanical Damaget	Chip on ledge with ITO side (for pin & COG model)	F	1- $X \leq 1/2$ width of single ITO 2- $Y < 1/10$ length of ledge 3- $Z < 1/10$ glass thickness ° Whichever out of spec is not accept.	 <p>This drawing only for with ITO side</p>
	Chip on ledge with ITO side (for Non pin & COG model)	F	When $Z < 1/2$ glass thickness: 1- $X \leq 3\text{mm}$; 2- $Y \leq 1/4$ length of ledge. When $Z \geq 1/2$ glass thickness: 1- $X \leq 2\text{mm}$; 2- $Y \leq 1/4$ length of ledge/4. Note: If glass thickness $< 0.7\text{mm}$, accept $Z = \text{glass thickness}$	
	Chip on ledge without ITO side (for pin & COG model)	F	When $Z < 1/2$ glass thickness: 1- $X \leq 5\text{mm}$; 2- $Y \leq 1/4$ length of ledge. When $Z \geq 1/2$ glass thickness: 1- $X \leq 2\text{mm}$; 2- $Y \leq 1/4$ length of ledge/4. Note: If glass thickness $< 0.7\text{mm}$, accept $Z = \text{glass thickness}$	
	Chip on ledge without ITO side (for Non pin & COG model)	F	When $Z < 3/4$ glass thickness: 1- $X \leq 5\text{mm}$; 2- $Y \leq 1/4$ length of ledge. When $Z \geq 3/4$ glass thickness: 1- $X \leq 2\text{mm}$; 2- $Y \leq 1/4$ length of ledge/4. Note: If glass thickness $< 0.7\text{mm}$, accept $Z = \text{glass thickness}$	
	Chip on end seal	H	Any chip can not be accept	
	Crack	A, B, C, D, E, F, G, H	Inspector shall attempt to remove the chip with tweezers. Re-evaluate if the remaining defect is still a crack or a chip. Reject chip or crack of any size in EVA.	
Ink printing defect	Ink misalignment The position of the ink shift.	A, B, C, D, E, F, G, H	Accept if the shift is within the tolerance and dimension specified in drawing. Unless otherwise specified, tolerance of ink printing shift should be $\pm 0.5\text{mm}$	
	Thick or thin ink. Ink line/pattern are thicker or thinner than that specified in the drawing	A, B, C	(a) Accept if thick or thin part is less than 10% or $\leq 0.15\text{mm}$. (b) Reject if thick or thin part is more than 10% or $\geq 0.15\text{mm}$ Thick part outside EVA can be removed with blade and the one inside EVA is not acceptable.	

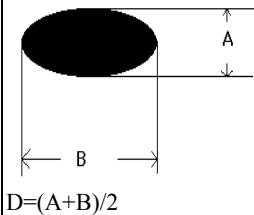
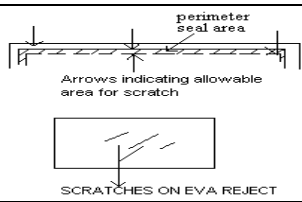
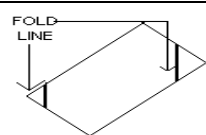
Defect Category	Defect Description	Zone	Criterion	Drawing Specification
Printing defect	Ink pattern or lines jagged	A, B	(a) Accept if thick or thin part is less than 10% or $\leq 0.15\text{mm}$. (b) Reject if thick or thin part is more than 10% or $\geq 0.15\text{mm}$	
	Uneven ink. Ink darker or lighter	A, B	Reject if darker or lighter than the color of sample	
	Dilapidation. Mesh with dilapidation results in leakage of ink and form dots on the glass that can't be removed with blade.	A, B	<u>Spot:</u> Diameter _____ Acc No. D \leq 0.1mm Any 0.1<D \leq 0.2mm 1 D>0.2mm 0	 D=(A+B)/2
	Date code defect of printed pattern: wrong pattern, fuzzy pattern, misalignment	Printed area	Not accept any wrong pattern and misalignment. Not accept any fuzzy pattern being difficult to identify. Pls. Refer to limit sample if there is.	
Polarizer defect	Scratch on transmissive polarizer	A, B	Reject if scratch inside VA	
		C	Accept if scratch outside VA	
	Scratch on reflective polarizer	A, B, C	Accepted scratch length: < 2.0mm, two scratches are allowed on reflective side. Accept if scratch could not be found when viewing on top of transmissive polarizer.	
	Scratch on transflective polarizer	A, B, C	Unacceptable if scratch observed with front light.	
	Folded line	A, B	Not accept on transmissive polarizer. Invisible fold on transflective or reflective polarizer is acceptable.	
	Mechanical damage	A, B	Not accept, i.e. dent or pinhole	
		C	Minor dint is acceptable. Serious dint like pinhole can not be accept.	
	Discoloration	A, B, C	Any discoloration can not be accept	
	Wrong or reversed polarizer	N/A	Not accept	
Polarizer shift or protrude from the edge of glass	N/A	1-Polarizer protruding can not be accept. 2-When polarizer position shift but still within perimeter sealed area, it is rejected if perimeter seal underneath is partially covered. 3- When polarizer position shift but still within perimeter sealed area, it is accepted if perimeter seal underneath could be perfectly seen.		



Defect Category	Defect Description	Zone	Criterion	Drawing Specification
Polarizer defect	Any peeling or delamination of polarizer	N/A	Not accept	
	Polarizer type not conform to the product specification	N/A	Not accept	
	Polarizer protecting film missing	N/A	Not accept. (unless requested by customer)	

6.7.3.4 Criterion for Functional Test after LC Filling:

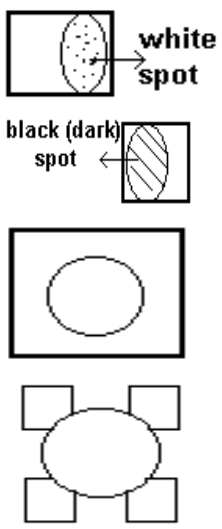
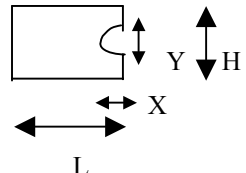
Defect category	Defect Description	Zone	Criterion	Drawing Specification
Fake zero	Black dot/spot fade out at activated state		Refer to the spot and lines spec.	
Black spot/ Pinhole at activated state	white spot at activated state. (for negative mode)	A	<u>Large size:</u> Diameter (mm) Acc No. D 0.1 Any 0.1<D 0.15 3 0.15<D 0.25 1 0.25<D 0	
			<u>Middle size:</u> Diameter (mm) Acc No. D 0.1 Any 0.1<D 0.15 1 0.15<D 0	
			<u>Small size:</u> Diameter (mm) Acc No. D 0.1 Any 0.1<D 0	
		B	1.5 times of acceptable largest diameter size of Zone A	
		C	Accept any quantity and size except voids and reverse twist. But the reverse twist can be accept if it happened in zone c without PI coat.	
black spot / pin hole at activated state. (for positive mode)		A	<u>Large size:</u> Diameter (mm) Acc No. D 0.15 Any 0.15<D 0.3 5 0.3<D 0.4 2 0.4<D 0	
			<u>Middle size:</u> Diameter (mm) Acc No. D 0.1 Any 0.1<D 0.2 2 0.2<D 0.3 1 0.3<D 0	
			<u>Small size:</u> Diameter (mm) Acc No. D 0.1 Any 0.1<D 0.2 1 0.2<D 0	
		B	1.5 times of acceptable largest diameter size of Zone A	
		C	Accept any quantity and size except voids and reverse twist. But the reverse twist can be accept if it happened in zone c without PI coat.	
Dot Matrix		A	Dot matrix pinhole size must meet X and $Y \leq 2/3L, H$ or $\leq 0.2\text{mm}$, whichever is greater	

Remark: 1. All above black spot/ foreign material defects min. space shall be $\geq 20\text{mm}$.

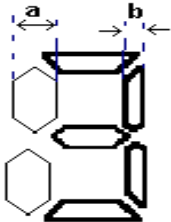
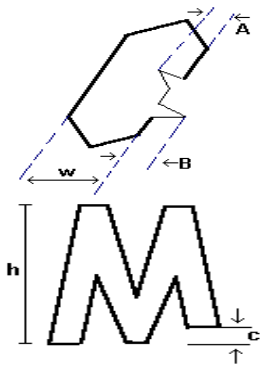
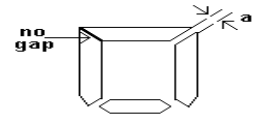
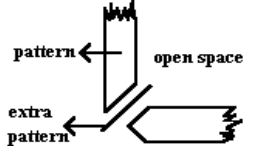
Defect Category	Defect Description	Zone	Criterion	Drawing Specification
COMMON open	Part or all pattern do not light up	N/A	Not accept	
SEGMENT open	One or few pattern segment does not light up	N/A	Not accept	
Pattern deformation	Segment fatter or smaller	N/A	Segment fatter than 110% or smaller than 90% of the designed value. Reject: $ (a-b) / b \geq 10\%$	
	Pattern deformation	N/A	Missing pattern or extra pattern >0.1mm, or >20% designed pattern width is unacceptable Reject: A or B > 0.1mm (A or B)/W > 20% Missing pattern or extra pattern >0.2mm or >1/8 designed height is unacceptable. Reject: C > 0.2mm C > 1/8H	
	The gap width between patterns out of limit	N/A	Reject: a < 0.1mm a > 0.3mm	
	Black line between segments.	N/A	Accept if invisible at 30cm distance. For game application, the excess black line is acceptable if it does not affect the visibility.	
COM-COM short	COM and COM connected	N/A	Not accept	
SEG-SEG short	SEG and SEG connected	N/A	Not accept	
COM-SEG short	COM and SEG connected	N/A	Not accept	
Darker/Lighter	Pattern darker or lighter than standard sample at activated state.	N/A	Refer to standard sample	
High current	Current exceed designed value	N/A	When power on, the pointer of short-circuit tester swing to MAX and then back, while the indicator lights up then goes out	

“Varitronix Limited reserves the right to change this specification.”

FAX:(852) 2343-9555.

URL:<http://www.varitronix.com>