

## General Specifications

### Electrical Capacity (Resistive Load)

<b>Switching Rating:</b>	100mA @ 5V DC
<b>Nonswitching Rating:</b>	100mA @ 50V DC

### Other Ratings

<b>Contact Resistance:</b>	100 milliohms maximum for circuit; 30 milliohms maximum for contact point
<b>Insulation Resistance:</b>	1,000 megohms minimum @ 250V DC
<b>Dielectric Strength:</b>	250V AC minimum for 1 minute minimum
<b>Mechanical Life:</b>	10,000 detent operations minimum
<b>Electrical Life:</b>	10,000 detent operations minimum

Notes: A detent operation is one actuator position operation or stepping.  
A cycle is one 360° rotation. 10,000 detent operations equal 625 cycles for hexadecimal devices or 1,000 cycles for decimal devices.

<b>Nominal Operating Torque:</b>	0.008Nm for decimal devices; 0.01Nm for hexadecimal devices
<b>Contact Timing:</b>	Nonshorting

### Materials & Finishes

<b>Actuator:</b>	Screwdriver and Plastic Shaft - Glass fiber reinforced polyamide (UL94V-0)
<b>Housing &amp; Base:</b>	Glass fiber reinforced polyamide (UL94V-0)
<b>Leaf Spring:</b>	Stainless steel
<b>Movable Contacts:</b>	Copper alloy with gold plating
<b>Stationary Contacts:</b>	Phosphor bronze with gold plating
<b>Terminals:</b>	Phosphor bronze with gold plating

### Environmental Data

<b>Operating Temperature Range:</b>	-25°C through +85°C (-13°F through +185°F)
<b>Humidity:</b>	90 ~ 95% humidity for 240 hours @ 40°C (104°F)
<b>Vibration:</b>	10 ~ 55Hz with peak-to-peak amplitude of 1.5mm traversing the frequency range & returning in 5 minutes; 3 right angled directions for 2 hours
<b>Shock:</b>	50G (490m/s <sup>2</sup> ) acceleration (tested in 6 right angled directions, with 5 shocks in each direction)

### Processing

<b>Soldering:</b>	Reflow Soldering Recommended. See Profile A in Supplement section. Manual Soldering: See Profile A in Supplement section. Note: During soldering process, set the switch to the following position: FR02FR10P, FR02FR16P, FR02KR10P, FR02KR16P: 0 position; FR02FC10P, FR02KC10P: 7 position; FR02FC16P, FR02KC16P: F position
<b>Cleaning:</b>	These devices are not process sealed. Hand clean locally using alcohol based solution.

### Standards & Certifications

<b>Flammability Standards:</b>	UL94V-0 rated actuator, housing, & base The FR02 Series rotaries have not been tested for UL recognition or CSA certification. These switches are designed for use in a low-voltage, low-current circuit. When used as intended, the results do not produce hazardous energy.
--------------------------------	----------------------------------------------------------------------------------------------------------------------------------------------------------------------------------------------------------------------------------------------------------------------------------

# Distinctive Characteristics

Slim .150" (3.8mm) body has the lowest profile in the industry and allows close stacking of PC boards.

Highly visible legends and choice of screwdriver or shaft actuators with arrow position indication provide trouble-free code setting.

Detent mechanism gives crisp, positive action for accurate switch setting.

Use of heat resistant resin allows infrared convection reflow soldering.

Gull-winged terminals ensure mechanical stability during soldering and simplify solder joint inspection.

Cam activated movable contact and gold contacts assure contact reliability and continuity.

Tape-reel packaging meets EIA-481-2 Standard.

Coplanarity: all considered surfaces must lie between two parallel planes that are a maximum distance apart of .0059" (0.15mm). (Additional coplanarity details in Terms and Acronyms in the Supplement section.)

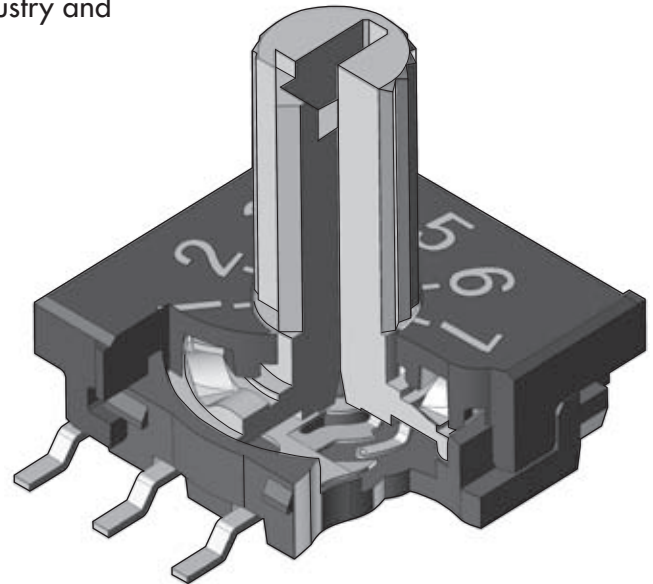

Actual Size

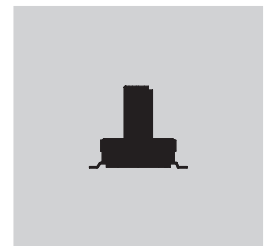

## TRUTH TABLES (CIRCUITS & POSITIONS)

Terminal No. (Output)	Actuator Position ● = ON	10 Decimal										16 Hexadecimal															
		0	1	2	3	4	5	6	7	8	9	0	1	2	3	4	5	6	7	8	9	A	B	C	D	E	F
<b>R</b> Real Coded Model Numbers: FR02FR, FR02KR	1		●		●		●		●		●		●		●		●		●		●		●		●		●
	2			●	●			●	●				●	●			●	●				●	●			●	●
	4					●	●	●	●					●	●	●	●					●	●	●	●		
	8									●	●									●	●	●	●	●	●	●	●
<b>C</b> Complement Coded Model Numbers: FR02FC, FR02KC	1	●		●		●		●		●		●		●		●		●		●		●		●		●	
	2	●	●			●	●		●	●	●	●			●	●			●	●			●	●			
	4	●	●	●	●				●	●	●	●	●						●	●	●	●					
	8	●	●	●	●	●	●	●						●	●	●	●	●									

Terminal numbers are actually on the switch.

### TYPICAL SWITCH ORDERING EXAMPLE

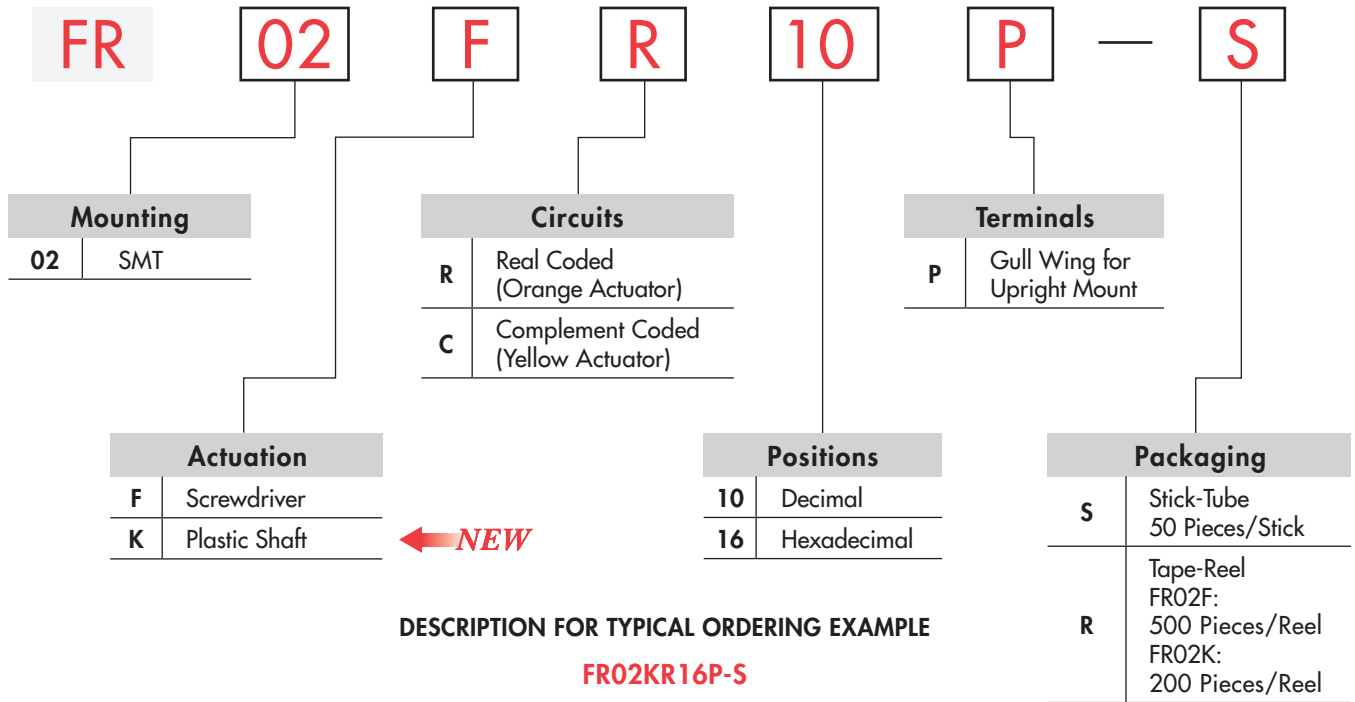

### DESCRIPTION FOR TYPICAL ORDERING EXAMPLE

**FR02KR16P-S**

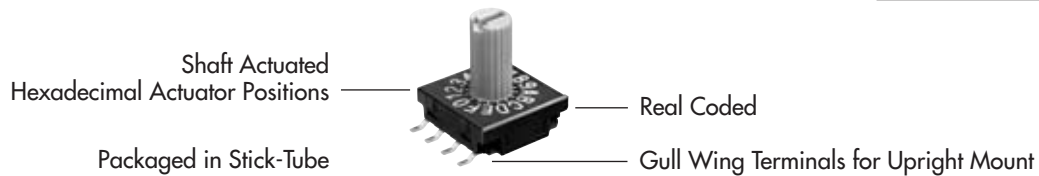

### ACTUATION

**F** Screwdriver  
Adjusted with a flat tipped screwdriver

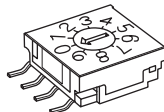

**K** Plastic Shaft **← NEW**  
Adjusted by hand or with flat tipped screwdriver

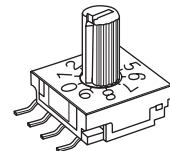

Actuators are fully rotational either clockwise or counterclockwise.  
Actuator Colors: Orange for real coded devices; Yellow for complement coded devices.

### TYPICAL SWITCH DIMENSIONS

**P** Upright • Screwdriver



**FR02FC10P**

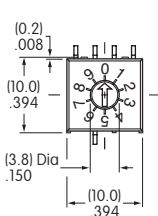

Decimal

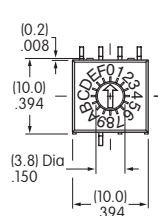

Hexadecimal

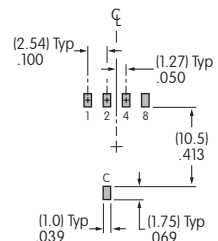
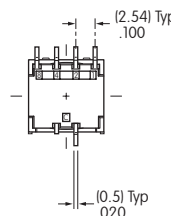
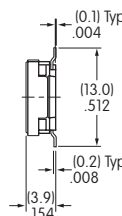

TYPICAL SWITCH DIMENSIONS

Upright • Plastic Shaft

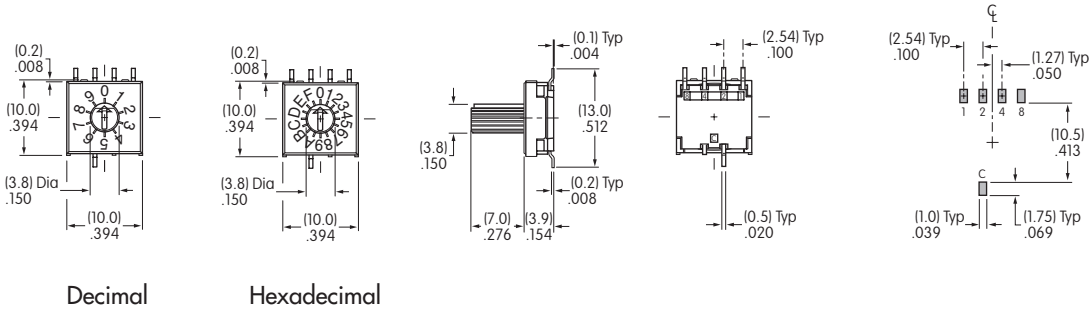

FR02KC16P

PACKAGING

**S** Stick-Tube

**FR02F & FR02K**  
Each stick-tube contains 50 switches.  
Switches must be ordered in 50-piece increments.

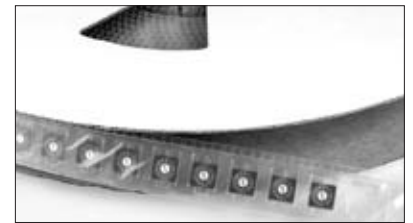
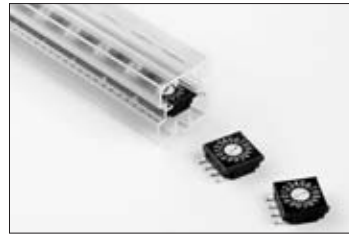
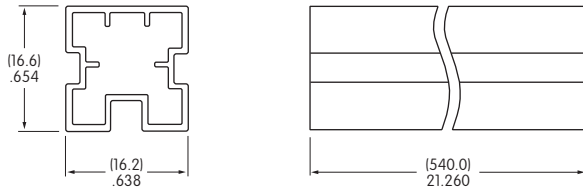

**R** Tape-Reel

**FR02F**  
Switches must be ordered in 500-piece increments.  
This packaging meets EIA-481-2 Standard.

Each tape-reel of 550 pockets contains 500 switches.  
Minimum Leader Length: 15.748" (400mm)  
Minimum Trailer Length: 6.299" (160mm)

**FR02K**  
Switches must be ordered in 200-piece increments.  
This packaging meets EIA-481-2 Standard.

Each tape-reel of 250 pockets contains 200 switches.  
Minimum Leader Length: 15.748" (400mm)  
Minimum Trailer Length: 6.299" (160mm)

