

FILTER - TUNABLE, BAND PASS SMT 10 - 18 GHz



Typical Applications

The HMC896LP4E is ideal for:

- Test & Measurement Equipment
- Military RADAR & EW/ECM
- SATCOM & Space
- Industrial & Medical Equipment

Functional Diagram

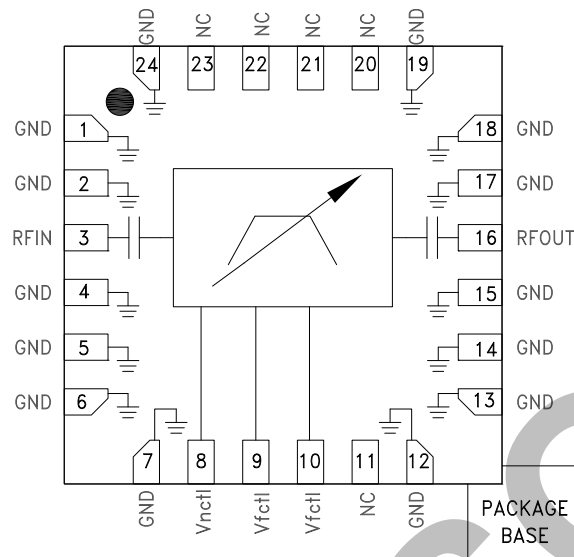

Features

- Fast Tuning Response
- Excellent Wideband Rejection
- Tunable low side/high side rejection “notch”
- Single Chip Replacement for Mechanically Tuned Designs
- 24 Lead 4x4 mm SMT Package

General Description

The HMC896LP4E is a MMIC band pass filter which features a user selectable passband frequency. The 3 dB filter bandwidth is approximately 9%. The 20 dB filter bandwidth is approximately 22%. The center frequency can be varied between 10 and 18 GHz by applying an analog tune voltage between 0 and 14V. This tunable filter can be used as a much smaller alternative to physically large switched filter banks and cavity tuned filters. The HMC896LP4E has excellent microphonics due to the monolithic design, and provides a dynamically adjustable solution in advanced communications applications.

Electrical Specifications, $T_A = +25\text{ }^\circ\text{C}$, $V_{fctl} = V_{nctl}$ Unless Otherwise Stated

Parameter	Min.	Typ.	Max.	Units
F_{center} Tuning Range	10		18	GHz
3 dB Bandwidth		9		%
Low Side Rejection Frequency (Rejection >20 dB)		$0.89 * F_{center}$		GHz
High Side Rejection Frequency (Rejection >20 dB)		$1.10 * F_{center}$		GHz
Low Side Sub-Harmonic Rejection (Rejection >40 dB)		$0.75 * F_{center}$		GHz
High Side Sub-Harmonic Rejection (Rejection >40 dB)		$1.18 * F_{center}$		GHz
Re-entry Frequency (Rejection <30 dB)		>40		GHz
Insertion Loss		9		dB
Return Loss (2 dB bandwidth)		11		dB
Input IP3 (Pin = 0 to +15 dBm)		26		dBm
Input Power @ 5° Shift In Insertion Phase ($V_{fctl} = 0V$)		8		dBm
Input Power @ 5° Shift In Insertion Phase ($V_{fctl} = 1V$)		12		dBm
Frequency Control Voltage (V_{fctl})	0		14	V
Source/Sink Current (I_{fctl})			±1	mA
Low Side/High Side Rejection Control Voltage (V_{nctl})	0		14	V
Source/Sink current (I_{nctl})			±1	mA
Residual Phase Noise [1] (100 kHz Offset)		-158		dBc/Hz
F_{center} Drift Rate		-1.5		MHz/°C
Tuning Speed, Phase Settling to within 10° [2]		< 200		ns

[1] Optimum residual phase noise performance requires the use of a low noise driver circuit.

[2] Tuning speed includes 40 ns tuning voltage ramp from driver.



**FILTER - TUNABLE, BAND PASS SMT
10 - 18 GHz**

Broadband Insertion Loss, Vfctl = Vnctl

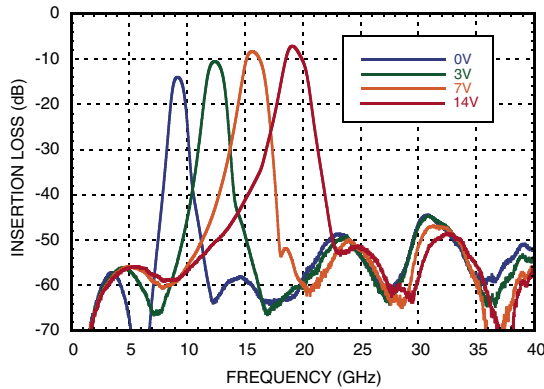

Broadband Return Loss, Vfctl = Vnctl

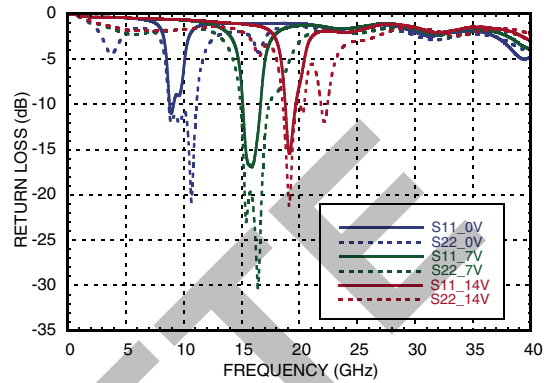

Insertion Loss, Vfctl = Vnctl

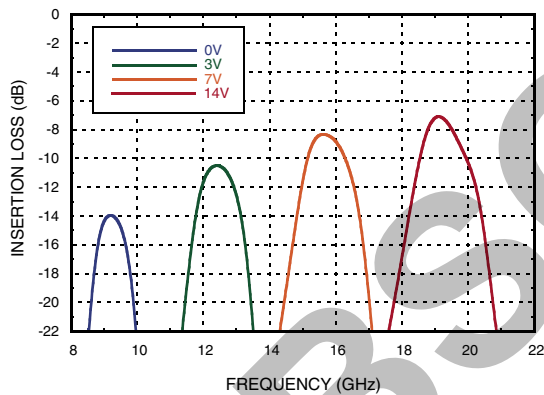

Return Loss, Vfctl = Vnctl

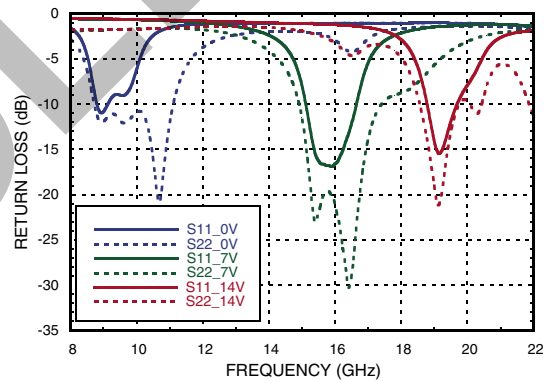

**Insertion Loss vs. Temperature
Vfctl = Vnctl = 7V**

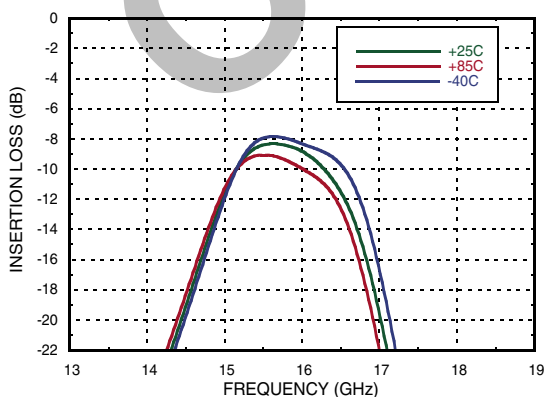

**Return Loss vs. Temperature
Vfctl = Vnctl = 7V**

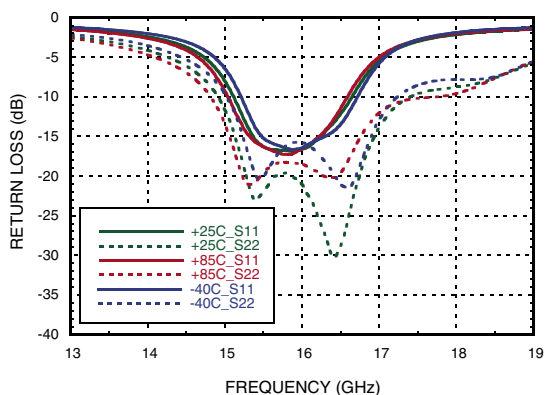



**FILTER - TUNABLE, BAND PASS SMT
10 - 18 GHz**

FILTERS - TUNABLE - SMT

**Insertion Loss vs. Vnctl, Low Side
Vfctl = 7V**

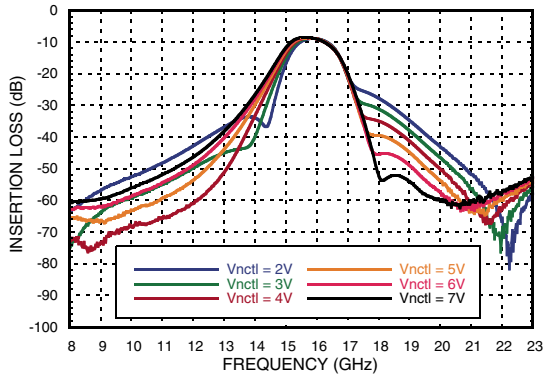

**Insertion Loss vs. Vnctl, High Side
Vfctl = 7V**

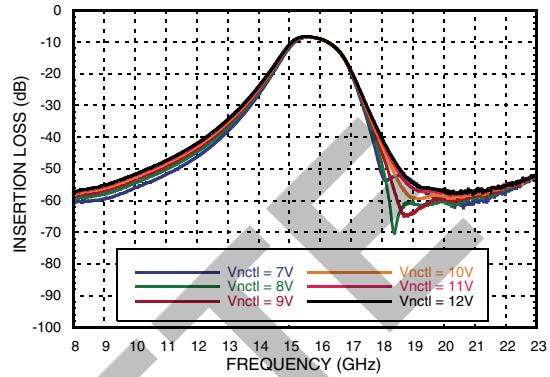

**Center Frequency vs. Temperature,
Vfctl = Vnctl**

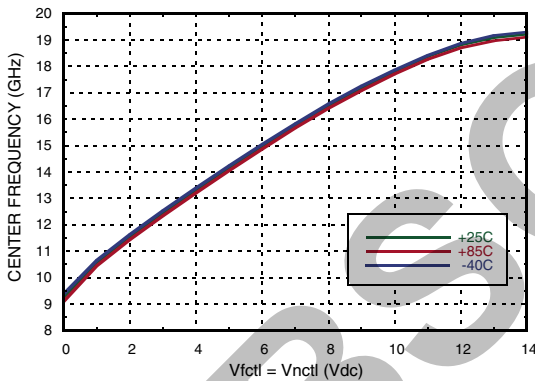

**Insertion Loss vs. Temperature,
Vfctl = Vnctl**

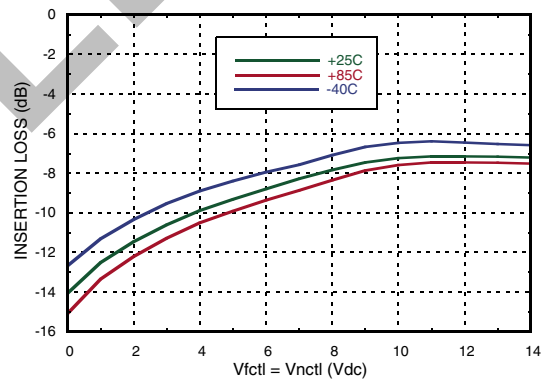

**3 dB Bandwidth vs. Temperature,
Vfctl = Vnctl**

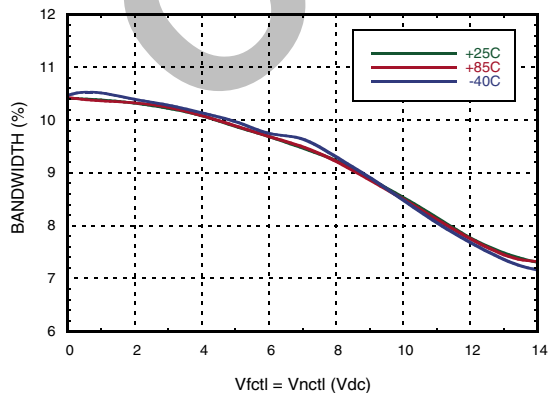

**Input Return Loss in a 2 dB Bandwidth
vs. Temperature, Vfctl = Vnctl**

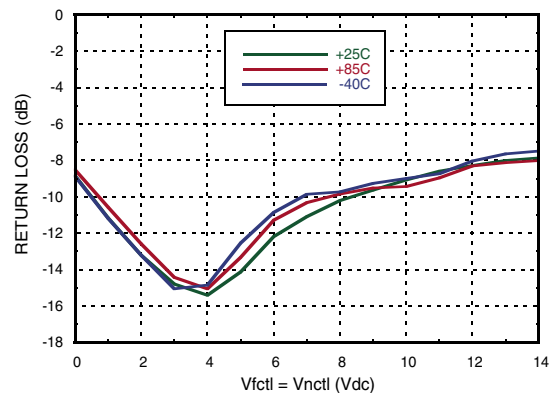

Information furnished by Analog Devices is believed to be accurate and reliable. However, no responsibility is assumed by Analog Devices for its use, nor for any infringements of patents or other rights of third parties that may result from its use. Specifications subject to change without notice. No license is granted by implication or otherwise under any patent or patent rights of Analog Devices. Trademarks and registered trademarks are the property of their respective owners.

For price, delivery, and to place orders: Analog Devices, Inc., One Technology Way, P.O. Box 9106, Norwood, MA 02062-9106 Phone: 781-329-4700 • Order online at www.analog.com Application Support: Phone: 1-800-ANALOG-D



**FILTER - TUNABLE, BAND PASS SMT
10 - 18 GHz**

Low Side Rejection Ratio vs. Temperature [1]

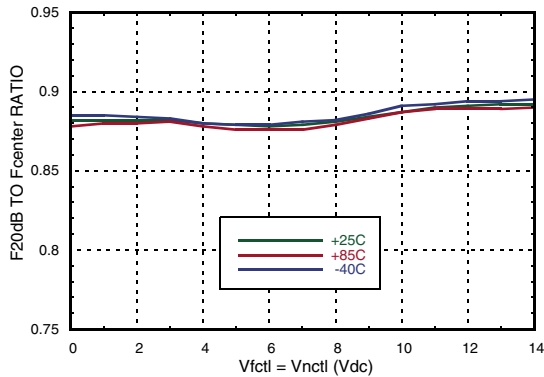

High Side Rejection Ratio vs. Temperature [1]

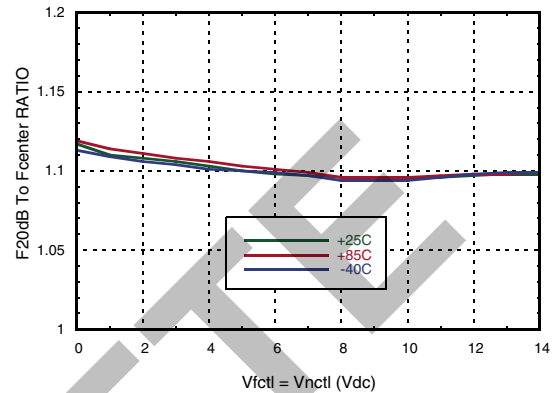

Tuning Sensitivity vs. Temperature

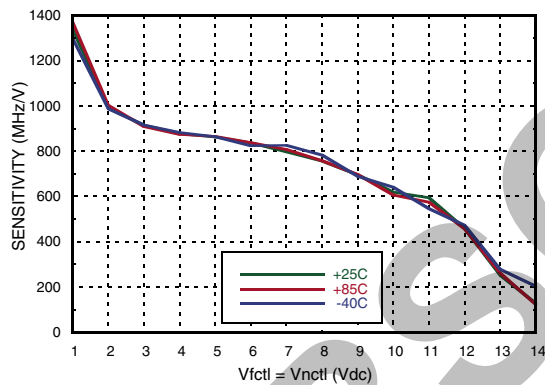

Group Delay vs. Frequency

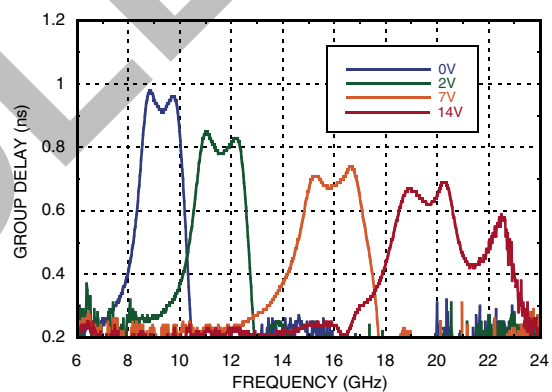

Group Delay vs. Fcenter vs. Temperature

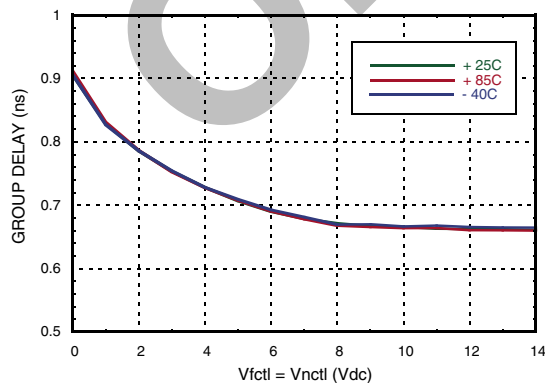

Input IP3 vs. Temperature

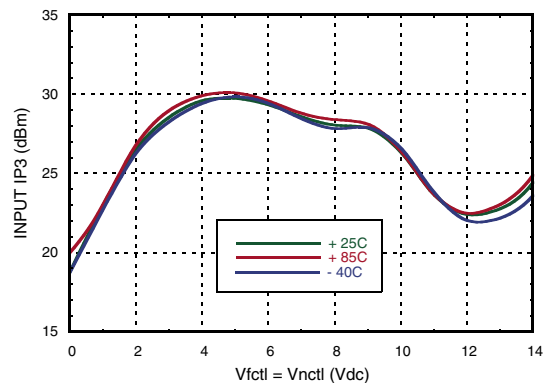

[1] Rejection ratio is defined as the ratio of the frequency at which the relative insertion loss is 20 dB to f_{center}



**FILTER - TUNABLE, BAND PASS SMT
10 - 18 GHz**

Residual Phase Noise, Vfctl = Vnctl

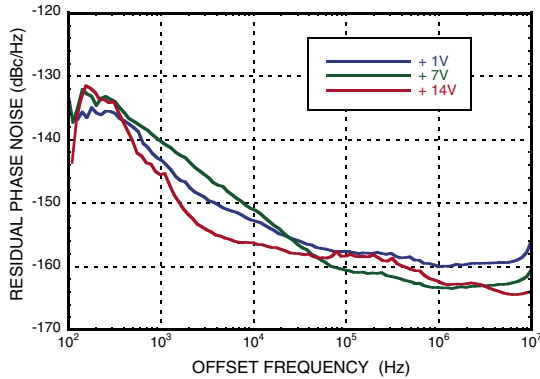

Phase Sensitivity vs. Vfctl

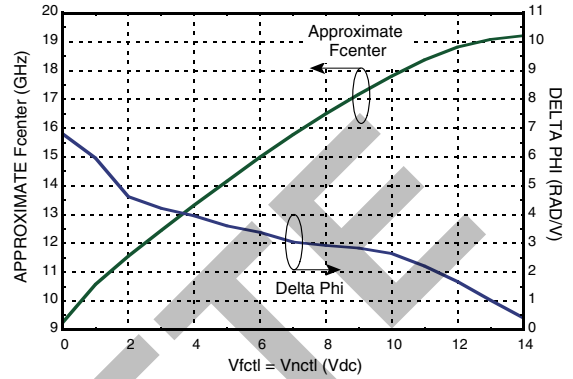

**Insertion Phase vs. Input Power
Vfctl = Vnctl**

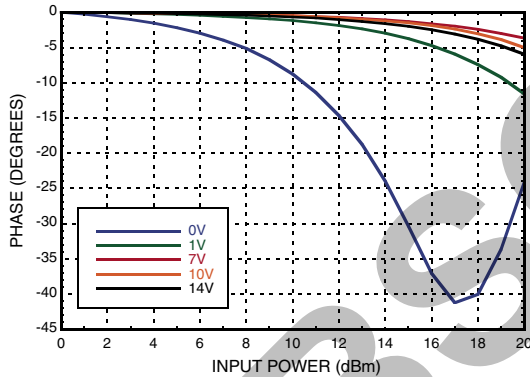

**Fcenter vs. Input Power
Vfctl = Vnctl**

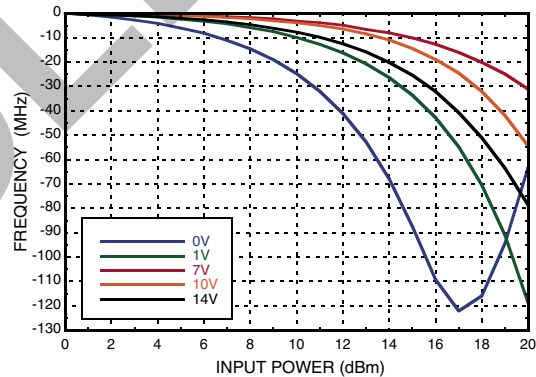

Absolute Maximum Ratings

Frequency Control Voltage (Vfctl)	-0.5 to +15V
Notch Control Voltage (Vnctl)	-0.5 to +15V
RF Power Input	27 dBm
Storage Temperature	-65 to +150 °C
ESD Sensitivity (HBM)	Class 1A

Reliability Information

Junction Temperature to Maintain 1 Million Hour MTTF	150 °C
Nominal Junction Temperature (T= 85 °C and Pin = 27 dBm)	103 °C
Operating Temperature	-40 to +85 °C



**ELECTROSTATIC SENSITIVE DEVICE
OBSERVE HANDLING PRECAUTIONS**

Information furnished by Analog Devices is believed to be accurate and reliable. However, no responsibility is assumed by Analog Devices for its use, nor for any infringements of patents or other rights of third parties that may result from its use. Specifications subject to change without notice. No license is granted by implication or otherwise under any patent or patent rights of Analog Devices. Trademarks and registered trademarks are the property of their respective owners.

For price, delivery, and to place orders: Analog Devices, Inc., One Technology Way, P.O. Box 9106, Norwood, MA 02062-9106 Phone: 781-329-4700 • Order online at www.analog.com Application Support: Phone: 1-800-ANALOG-D

FILTER - TUNABLE, BAND PASS SMT 10 - 18 GHz



Outline Drawing

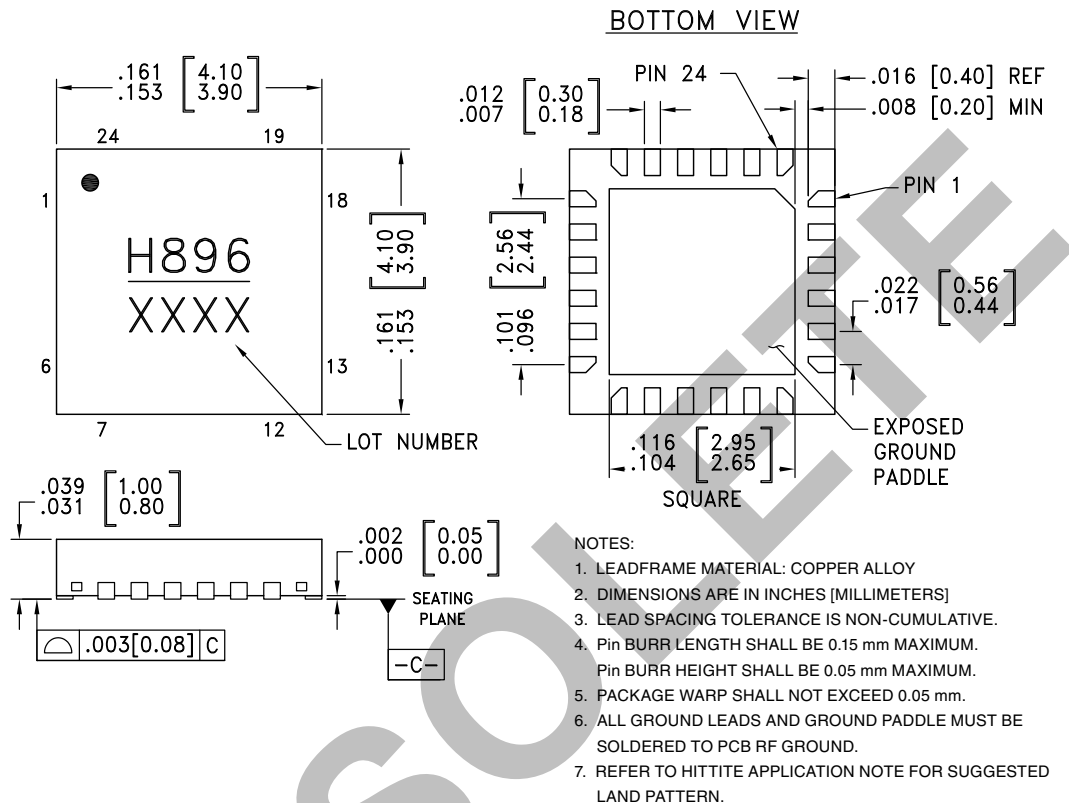

Package Information

Part Number	Package Body Material	Lead Finish	MSL Rating	Package Marking ^[1]
HMC896LP4E	RoHS-compliant Low Stress Injection Molded Plastic	100% matte Sn	MSL1 ^[2]	H896 XXXX

[1] 4-Digit lot number XXXX

[2] Max peak reflow temperature of 260 °C



FILTER - TUNABLE, BAND PASS SMT
10 - 18 GHz

Pin Descriptions

Pin Number	Function	Description	Interface Schematic
1, 2, 4 - 7, 12 - 15, 17 - 19, 24	GND	These pins and exposed paddle must be connected to RF/DC ground.	GND
11, 20 - 23	NC	The pins are not connected internally; however, all data shown herein was measured with these pins connected to RF/DC ground externally	
3	RFIN	This pin is AC coupled and matched to 50 Ohms.	RFIN 2 pF
8	Vnctl	Low side/high side notch control voltage.	Vnctl 1.5 kΩ 4 pF 1.2 pF
9	Vfctl	Center frequency control voltage.	Vfctl 5 Ω 0.5 nH 125 Ω 16 pF 17 pF
10	Vfctl	Center frequency control voltage.	Vfctl 10 Ω 0.7 nH 170 Ω 4 pF 9 pF
16	RFOUT	This pin is AC coupled and matched to 50 Ohms.	2 pF RFOUT

Application Circuit

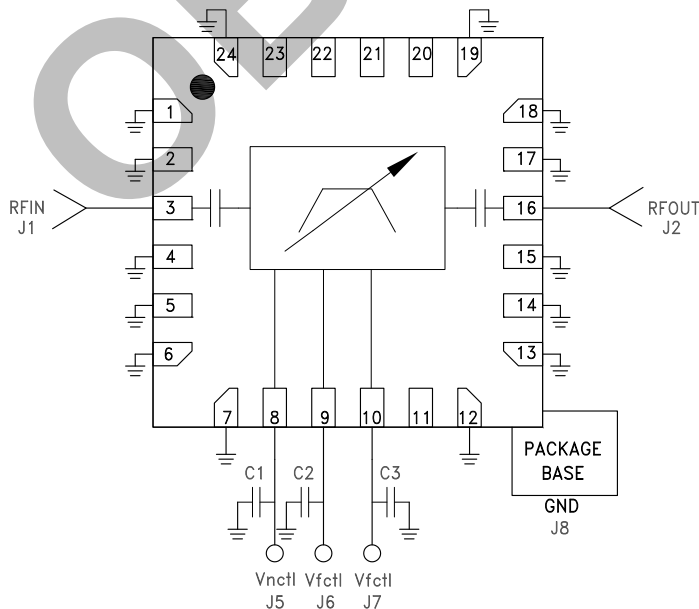

Information furnished by Analog Devices is believed to be accurate and reliable. However, no responsibility is assumed by Analog Devices for its use, nor for any infringements of patents or other rights of third parties that may result from its use. Specifications subject to change without notice. No license is granted by implication or otherwise under any patent or patent rights of Analog Devices. Trademarks and registered trademarks are the property of their respective owners.

For price, delivery, and to place orders: Analog Devices, Inc., One Technology Way, P.O. Box 9106, Norwood, MA 02062-9106 Phone: 781-329-4700 • Order online at www.analog.com Application Support: Phone: 1-800-ANALOG-D



Evaluation PCB

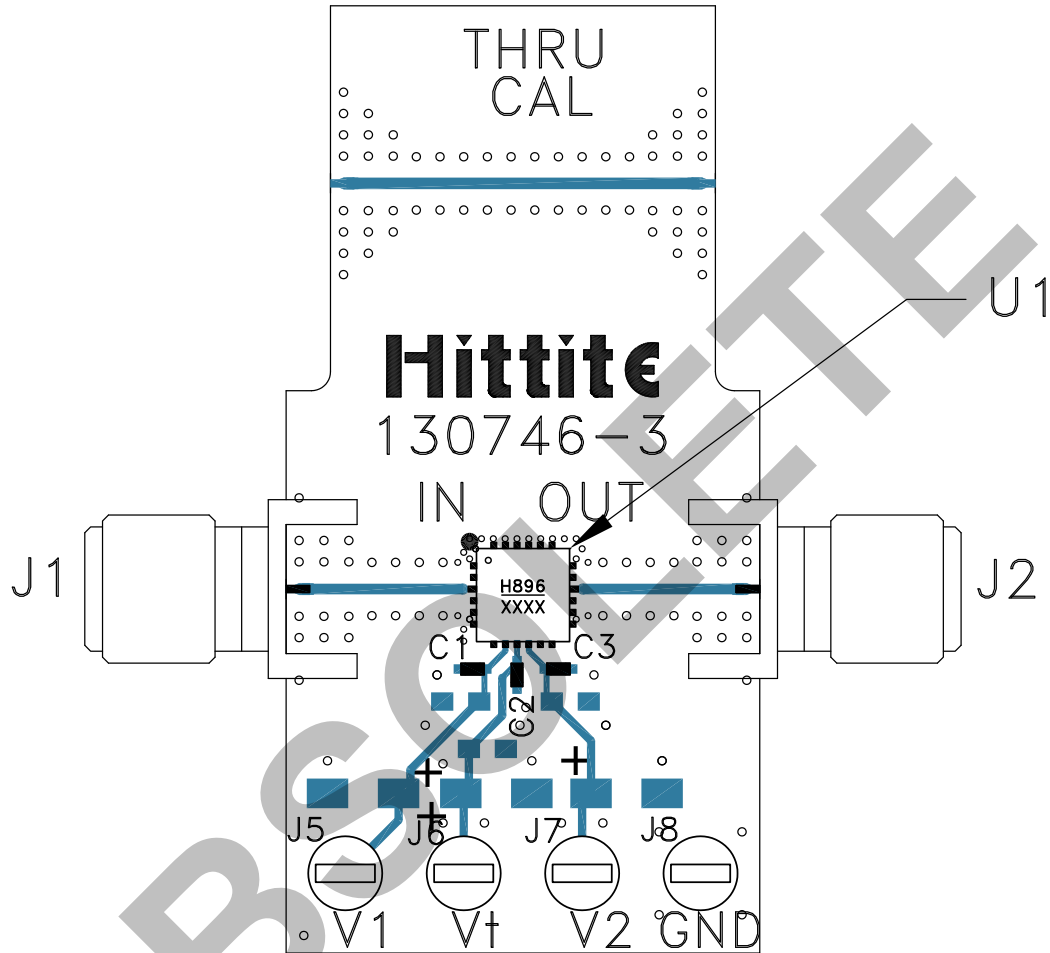

List of Materials for Evaluation PCB 131085 [1]

Item	Description
J1, J2	Connector, 2.9mm, Female
J5, J6, J7, J8	DC Pin
C1, C2, C3	100 pF Capacitor, 0402 Pkg.
U1	HMC896LP4E Filter - Tunable
PCB [2]	130746 Evaluation PCB

[1] Reference this number when ordering complete evaluation PCB

[2] Circuit Board Material: Arlon 25FR or Rogers 25FR

The circuit board used in the application should use RF circuit design techniques. Signal lines should have 50 Ohms impedance while the package ground leads and exposed paddle should be connected directly to the ground plane similar to that shown. A sufficient number of via holes should be used to connect the top and bottom ground planes. The evaluation circuit board shown is available from Hittite upon request.