

Panasonic
ideas for life

10A to 40A
hockey puck type

AQ-R RELAYS

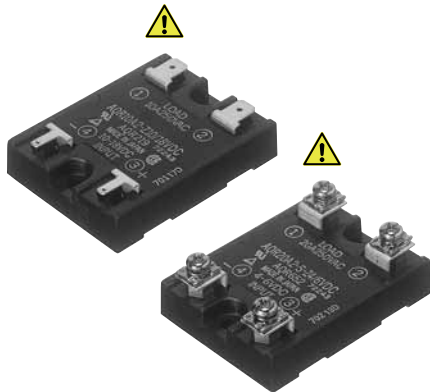

⚠ Product is discontinued.

FEATURES

1. Two types of terminal shape: Plug-in terminal and Screw terminal (30 A, 40 A is screw terminal types only)
2. Flat type of SSR possible by aluminium printed circuit board
3. High dielectric strength of 1,500 V between input and output. 4,000 V available for 10A, 15A, 20A devices.
4. Heat sink and DIN mounting rail and terminal cover are available as accessories

APPLICATIONS

1. Molding machine (heater control)
2. Temperature controlled bath (heater control)
3. Printing machine (heater control)
4. Machine tool (motor control)

TYPES

1. Plug-in terminal type

Type	Load voltage	Input voltage	Standard (1,500V AC)	Reinforced (4,000V AC)
			Part No.	Part No.
Zero-cross 10 A	75 to 125V AC	4 to 6V DC	AQR10A1-Z4/6VDC	—
		10 to 18V DC	AQR10A1-Z10/18VDC	—
		18 to 28V DC	AQR10A1-Z18/28VDC	—
	75 to 250V AC	4 to 6V DC	AQR10A2-Z4/6VDC	AQR10A2-ZV4/6VDC
		10 to 18V DC	AQR10A2-Z10/18VDC	AQR10A2-ZV10/18VDC
		18 to 28V DC	AQR10A2-Z18/28VDC	AQR10A2-ZV18/28VDC
Zero-cross 15 A	75 to 125 V AC	4 to 6V DC	AQR15A1-Z4/6VDC	—
		10 to 18V DC	AQR15A1-Z10/18VDC	—
		18 to 28V DC	AQR15A1-Z18/28VDC	—
	75 to 250 V AC	4 to 6V DC	AQR15A2-Z4/6VDC	AQR15A2-ZV4/6VDC
		10 to 18V DC	AQR15A2-Z10/18VDC	AQR15A2-ZV10/18VDC
		18 to 28V DC	AQR15A2-Z18/28VDC	AQR15A2-ZV18/28VDC
Zero-cross 20 A	75 to 125 V AC	4 to 6V DC	AQR20A1-Z4/6VDC	—
		10 to 18V DC	AQR20A1-Z10/18VDC	—
		18 to 28V DC	AQR20A1-Z18/28VDC	—
	75 to 250 V AC	4 to 6V DC	AQR20A2-Z4/6VDC	AQR20A2-ZV4/6VDC
		10 to 18V DC	AQR20A2-Z10/18VDC	AQR20A2-ZV10/18VDC
		18 to 28V DC	AQR20A2-Z18/28VDC	AQR20A2-ZV18/28VDC

2. Screw-terminal type

Type	Load voltage	Input voltage	Standard (1,500V AC)	Reinforced (4,000V AC)
			Part No.	Part No.
Zero-cross 10 A	75 to 125 V AC	4 to 6V DC	AQR10A1-S-Z4/6VDC	—
		10 to 18V DC	AQR10A1-S-Z10/18VDC	—
		18 to 28V DC	AQR10A1-S-Z18/28VDC	—
	75 to 250 V AC	4 to 6V DC	AQR10A2-S-Z4/6VDC	AQR10A2-S-ZV4/6VDC
		10 to 18V DC	AQR10A2-S-Z10/18VDC	AQR10A2-S-ZV10/18VDC
		18 to 28V DC	AQR10A2-S-Z18/28VDC	AQR10A2-S-ZV18/28VDC
Zero-cross 15 A	75 to 125 V AC	4 to 6V DC	AQR15A1-S-Z4/6VDC	—
		10 to 18V DC	AQR15A1-S-Z10/18VDC	—
		18 to 28V DC	AQR15A1-S-Z18/28VDC	—
	75 to 250 V AC	4 to 6V DC	AQR15A2-S-Z4/6VDC	AQR15A2-S-ZV4/6VDC
		10 to 18V DC	AQR15A2-S-Z10/18VDC	AQR15A2-S-ZV10/18VDC
		18 to 28V DC	AQR15A2-S-Z18/28VDC	AQR15A2-S-ZV18/28VDC
Zero-cross 20 A	75 to 125 V AC	4 to 6V DC	AQR20A1-S-Z4/6VDC	—
		10 to 18V DC	AQR20A1-S-Z10/18VDC	—
		18 to 28V DC	AQR20A1-S-Z18/28VDC	—
	75 to 250 V AC	4 to 6V DC	AQR20A2-S-Z4/6VDC	AQR20A2-S-ZV4/6VDC
		10 to 18V DC	AQR20A2-S-Z10/18VDC	AQR20A2-S-ZV10/18VDC
		18 to 28V DC	AQR20A2-S-Z18/28VDC	AQR20A2-S-ZV18/28VDC
Zero-cross 30 A	75 to 250 V AC	4 to 6V DC	AQR30A2-S-Z4/6VDC	—
		10 to 18V DC	AQR30A2-S-Z10/18VDC	—
		18 to 28V DC	AQR30A2-S-Z18/28VDC	—
Zero-cross 40 A	75 to 250 V AC	4 to 6V DC	AQR40A2-S-Z4/6VDC	—
		10 to 18V DC	AQR40A2-S-Z10/18VDC	—
		18 to 28V DC	AQR40A2-S-Z18/28VDC	—

ORDERING INFORMATION

Ex. AQR 10A 1 — S — Z 4/6VDC

Load current	Load voltage	Terminal shape	Type	Input voltage
10 A, 15 A, 20 A, 30 A, 40 A	1: 75 to 125 V AC 2: 75 to 250 V AC	Nil: Plug-in terminal S: Screw terminal	Z: Zero-cross type (1,500 V) ZV: Zero-cross type (4,000 V)	4/6, 10/18, 18/28 V DC

Note: Standard packing: Carton 10 pcs., Case: 100 pcs.

SPECIFICATIONS

1. Ratings (at 20°C 68°F, Input ripple: 1% or less)

1) 10 A type

Items	Part No.	AQR10A1-Z4/ 6VDC	AQR10A1-Z10/ 18VDC	AQR10A1-Z18/ 28VDC	AQR10A2-Z4/ 6VDC AQR10A2-ZV4/ 6VDC	AQR10A2-Z10/ 18VDC AQR10A2-ZV10/ 18VDC	AQR10A2-Z18/ 28VDC AQR10A2-ZV18/ 28VDC	Remarks
		AQR10A1-S-Z4/ 6VDC	AQR10A1-S-Z10/ 18VDC	AQR10A1-S-Z18/ 28VDC	AQR10A2-S-Z4/ 6VDC AQR10A2-S-ZV4/ 6VDC	AQR10A2-S-Z10/ 18VDC AQR10A2-S- ZV10/18VDC	AQR10A2-S-Z18/ 28VDC AQR10A2-S- ZV18/28VDC	
Input side	Input voltage	4 to 6V DC	10 to 18V DC	18 to 28V DC	4 to 6V DC	10 to 18V DC	18 to 28V DC	
	Input impedance	Approx. 0.26 k Ω	Approx. 0.86 k Ω	Approx. 1.36 k Ω	Approx. 0.26 k Ω	Approx. 0.86 k Ω	Approx. 1.36 k Ω	
	Drop-out voltage, min.	1 V						
Load side	Max. load current	10 A						See "REFERENCE DATA 1"
	Load voltage	75 to 125 V AC			75 to 250 V AC			
	Frequency	45 to 65 Hz						
	Repetitive peak voltage	400 V			600 V			
	Non-repetitive surge current	100 A						In one cycle at 60 Hz
	Max. "OFF-state" leakage current	2.5 mA (when 100 V AC applied)			5 mA (when 200 V AC applied)			at 60 Hz
	Max. "ON-state" voltage drop	1.6 V						at max. carrying current
	Min. load current	100 mA						
OFF-state dV/dt	100 V/μs							

2) 15 A type

Items	Part No.	AQR15A1-Z4/ 6VDC	AQR15A1-Z10/ 18VDC	AQR15A1-Z18/ 28VDC	AQR15A2-Z4/ 6VDC AQR15A2-ZV4/ 6VDC	AQR15A2-Z10/ 18VDC AQR15A2-ZV10/ 18VDC	AQR15A2-Z18/ 28VDC AQR15A2-ZV18/ 28VDC	Remarks
		AQR15A1-S-Z4/ 6VDC	AQR15A1-S-Z10/ 18VDC	AQR15A1-S-Z18/ 28VDC	AQR15A2-S-Z4/ 6VDC AQR15A2-S-ZV4/ 6VDC	AQR15A2-S-Z10/ 18VDC AQR15A2-S- ZV10/18VDC	AQR15A2-S-Z18/ 28VDC AQR15A2-S- ZV18/28VDC	
Input side	Input voltage	4 to 6V DC	10 to 18V DC	18 to 28V DC	4 to 6V DC	10 to 18V DC	18 to 28V DC	
	Input impedance	Approx. 0.26 k Ω	Approx. 0.86 k Ω	Approx. 1.36 k Ω	Approx. 0.26 k Ω	Approx. 0.86 k Ω	Approx. 1.36 k Ω	
	Drop-out voltage, min.	1 V						
Load side	Max. load current	15 A						See "REFERENCE DATA 1"
	Load voltage	75 to 125 V AC			75 to 250 V AC			
	Frequency	45 to 65 Hz						
	Repetitive peak voltage	400 V			600 V			
	Non-repetitive surge current	150 A						In one cycle at 60 Hz
	Max. "OFF-state" leakage current	2.5 mA (when 100 V AC applied)			5 mA (when 200 V AC applied)			at 60 Hz
	Max. "ON-state" voltage drop	1.6 V						at max. carrying current
	Min. load current	100 mA						
OFF-state dV/dt	100 V/μs							

3) 20 A type

Items	Part No.	AQR20A1-Z4/ 6VDC	AQR20A1-Z10/ 18VDC	AQR20A1-Z18/ 28VDC	AQR20A2-Z4/ 6VDC AQR20A2-ZV4/ 6VDC	AQR20A2-Z10/ 18VDC AQR20A2-ZV10/ 18VDC	AQR20A2-Z18/ 28VDC AQR20A2-ZV18/ 28VDC	Remarks
		AQR20A1-S-Z4/ 6VDC	AQR20A1-S-Z10/ 18VDC	AQR20A1-S-Z18/ 28VDC	AQR20A2-S-Z4/ 6VDC AQR20A2-S-ZV4/ 6VDC	AQR20A2-S-Z10/ 18VDC AQR20A2-S- ZV10/18VDC	AQR20A2-S-Z18/ 28VDC AQR20A2-S- ZV18/28VDC	
Input side	Input voltage	4 to 6V DC	10 to 18V DC	18 to 28V DC	4 to 6V DC	10 to 18V DC	18 to 28V DC	
	Input impedance	Approx. 0.26 k Ω	Approx. 0.86 k Ω	Approx. 1.36 k Ω	Approx. 0.26 k Ω	Approx. 0.86 k Ω	Approx. 1.36 k Ω	
	Drop-out voltage, min.	1 V						
Load side	Max. load current	20 A						See "REFERENCE DATA 1"
	Load voltage	75 to 125 V AC			75 to 250 V AC			
	Frequency	45 to 65 Hz						
	Repetitive peak voltage	400 V			600 V			
	Non-repetitive surge current	200 A						In one cycle at 60 Hz
	Max. "OFF-state" leakage current	2.5 mA (when 100 V AC applied)			5 mA (when 200 V AC applied)			at 60 Hz
	Max. "ON-state" voltage drop	1.6 V						at max. carrying current
	Min. load current	100 mA						
	OFF-state dV/dt	100 V/μs						

4) 30 A type and 40 A type

Items	Part No.	AQR30A2-S-Z4/ 6VDC	AQR30A2-S-Z10/ 18VDC	AQR30A2-S-Z18/ 28VDC	AQR40A2-S-Z4/ 6VDC	AQR40A2-S-Z10/ 18VDC	AQR40A2-S-Z18/ 28VDC	Remarks	
	Input side	Input voltage	4 to 6V DC	10 to 18V DC	18 to 28V DC	4 to 6V DC	10 to 18V DC		18 to 28V DC
	Input impedance	Approx. 0.26 k Ω	Approx. 0.86 k Ω	Approx. 1.36 k Ω	Approx. 0.26 k Ω	Approx. 0.86 k Ω	Approx. 1.36 k Ω		
	Drop-out voltage, min.	1 V							
Load side	Max. load current	30 A			40 A			See "REFERENCE DATA 1"	
	Load voltage	75 to 250 V AC							
	Frequency	45 to 65 Hz							
	Non-repetitive surge current	300 A			400 A			In one cycle at 60 Hz	
	Max. "OFF-state" leakage current	5 mA (when 200 V AC applied)						at 60 Hz	
	Max. "ON-state" voltage drop	1.6 V						at max. carrying current	
	Min. load current	120 mA							

2. Characteristics (at 20°C 68°F, Input ripple: 1% or less)

Item	Type	Zero-cross type		Remarks
		Standard type	Reinforced type	
Operate time, max.		(1/2 cycle of voltage sine wave) + 1 ms		
Release time, max.		(1/2 cycle of voltage sine wave) + 1 ms		
Insulation resistance, min., Initial		100 M Ω between input, output and case		by 500V DC megger
Breakdown voltage		1,500 V AC between input, output and case	4,000 V AC between input, output and case	For 1 min.
Vibration resistance	Functional	10 to 55 Hz at double amplitude of 2 mm*		1 hour for X, Y, Z axes
	Destructive	10 to 55 Hz at double amplitude of 2 mm*		10 minutes for X, Y, Z axes
Shock resistance	Functional	Min. 980 m/s ² {100 G}		5 time each for X, Y, Z axes
	Destructive	Min. 980 m/s ² {100 G}		4 time each for X, Y, Z axes
Ambient temperature		-20°C to +80°C -4°F to +176°F		
Storage temperature		-25°C to +85°C -13°F to +185°F		
Operational method		Zero-cross (Turn-ON and Turn-OFF)		

Note: * 30 A and 40 A type is 10 to 55 Hz at double amplitude of 1.5 mm.

DIMENSIONS(mm inch)

Download [CAD Data](#) from our Web site.

1. Plug-in terminal

[CAD Data](#)

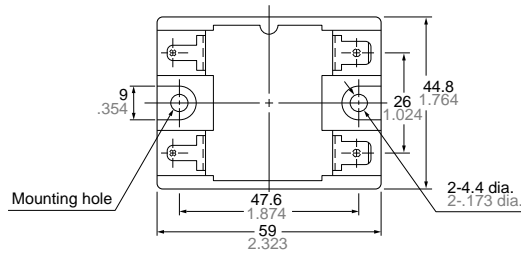

Conform to AMP plug-in terminal #110 series receptacle

Conform to AMP plug-in terminal #250 series receptacle

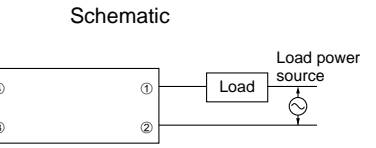

Mounting dimensions (Bottom view)

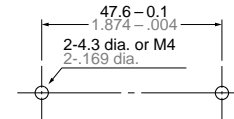

2. Screw terminal

[CAD Data](#)

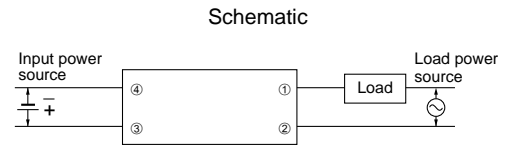
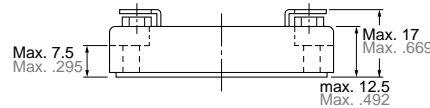
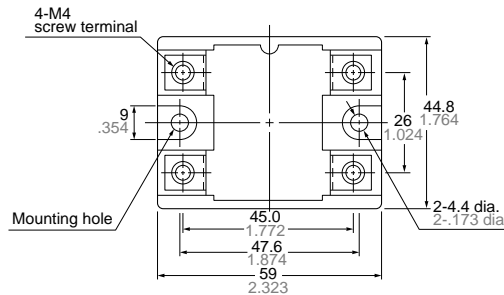

Mounting dimensions (Bottom view)

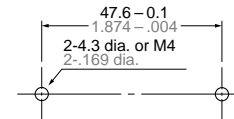

ACCESSORIES

Heat sink (For 10 A, 15A and 20 A)

[CAD Data](#)

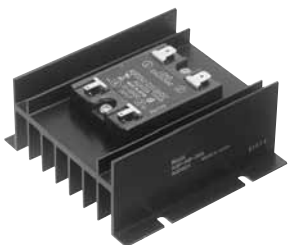

AQP-HS-20A

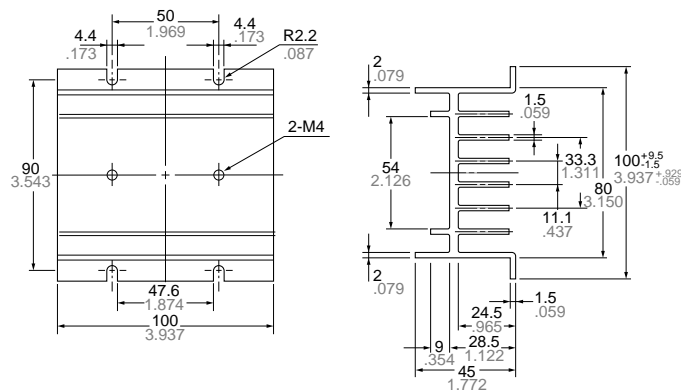

Mounting dimensions (Bottom view)

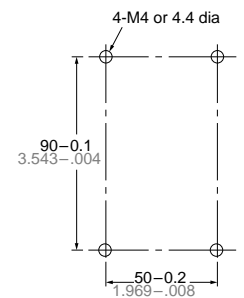

General tolerance: ±0.5

±0.020

⚠ Discontinued as of August 31, 2011

Heat sink (For 30 A, 40 A)

mm inch

CAD Data



AQP-HS-30/40A

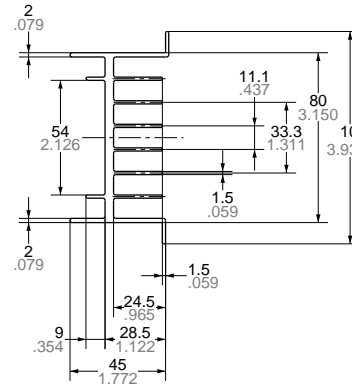
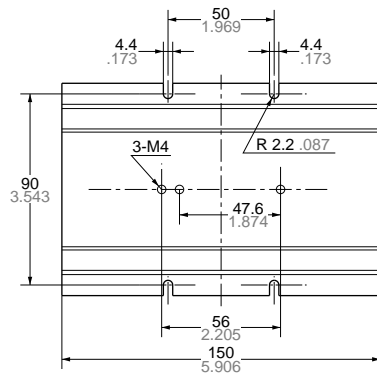

Mounting dimensions (Bottom view)

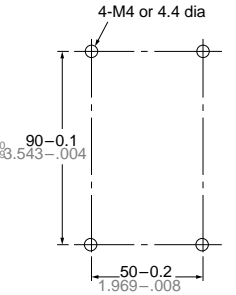

General tolerance: ± 0.5

± 0.20

With terminal cover

⚠ CAD Data

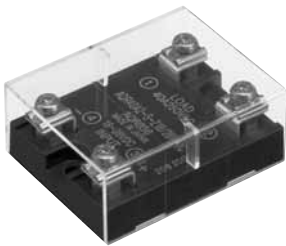

AQP-PC

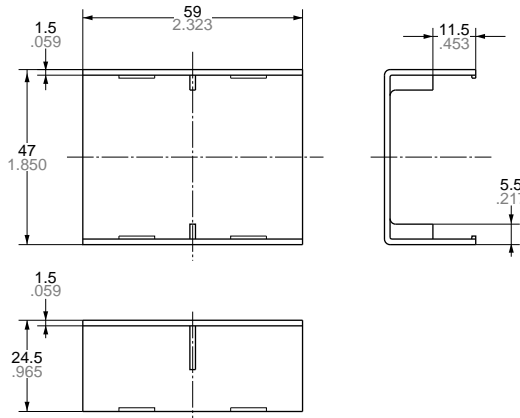

General tolerance: $\pm 0.5 \pm 0.20$

DIN rail mounting plate

CAD Data



AQP-DP

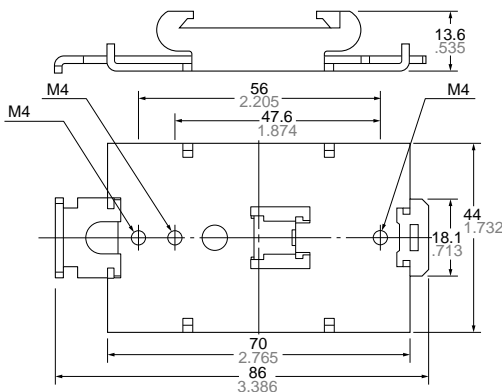

Mounting rail

CAD Data

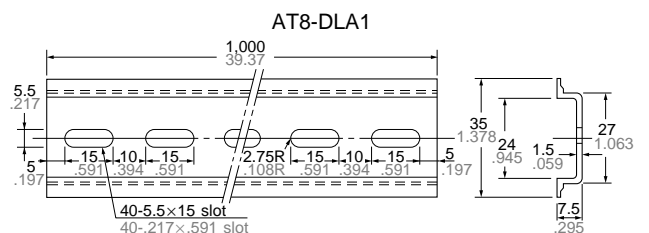

General tolerance: $\pm 0.5 \pm 0.20$

Fastening plate

mm inch

CAD Data



ATA4806

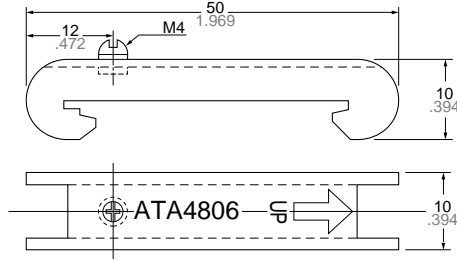

REFERENCE DATA

1. Load current vs. ambient temperature

Use load current within range specified in the figure below.

Tested condition:

With external heat sink

- 1) (1) 10 A, 15A, 20 A type
 - A heat sink; optional heat sink (AQP801) or a 150×150×3.2 mm aluminum sheet (painted black)
- (2) 30 A, 40 A type
 - Shown with standard heat sink (AQP804)

2) If attached to a heat sink, use a heat-conductive compound or similar coating to improve cooling.

Without external heat sink

If the mounting surface is not metallic and a heat sink is not used, expose the bottom surface and plate surface to improve heat dissipation.

The graphs show the characteristics when the relay is mounted as shown in the right figure.

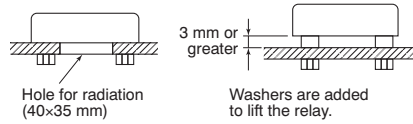

(1) 10 A type

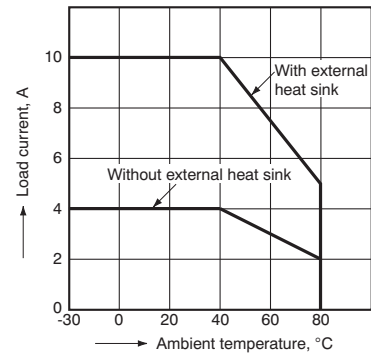

(2) 15 A type

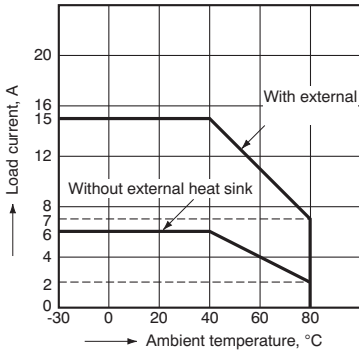

(3) 20 A type

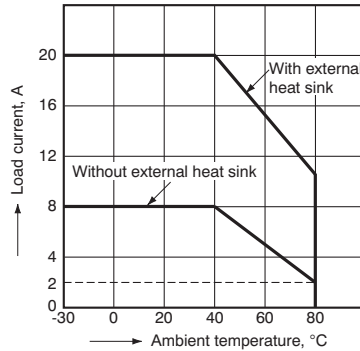

(4) 30 A type

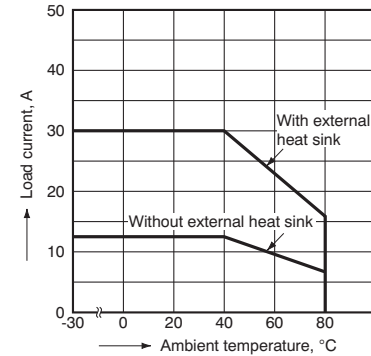

(5) 40 A type

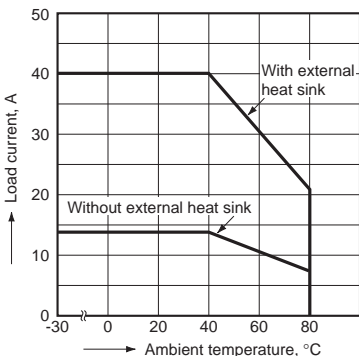

2-1. Non-repetitive surge current vs. carrying time (10 A type)

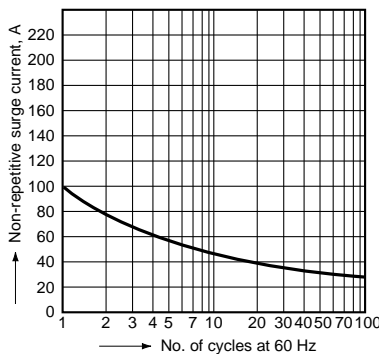

2-2. Non-repetitive surge current vs. carrying time (15 A type)

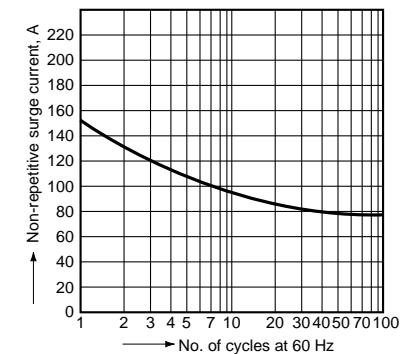

⚠ Discontinued as of August 31, 2011

2-3. Non-repetitive surge current vs. carrying time (20 A type)

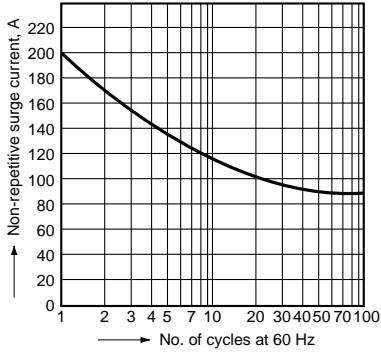

2-4. Non-repetitive surge current vs. carrying time (30 A, 40 A type)

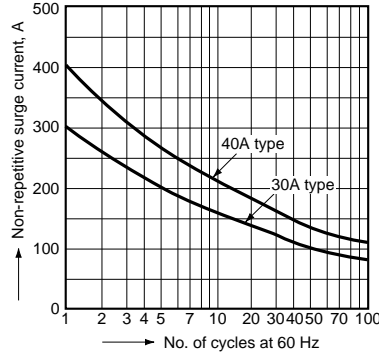

3. Input current vs. input voltage (10 A, 15 A, 20 A, 30 A, 40 A common)

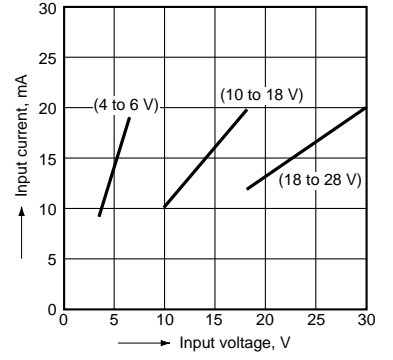

Cautions for Use