

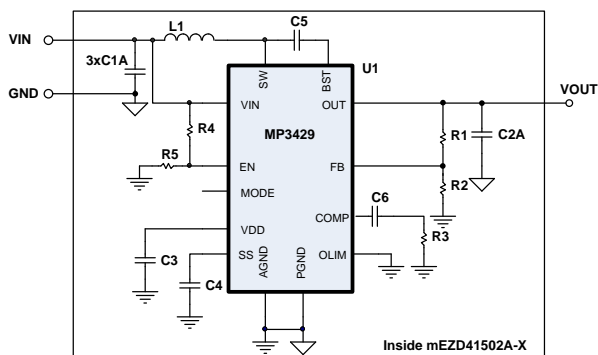

mEZ Product Options:

1. Ready-to-Use products
 2. Do-It-Yourself.
- Manufacture assistance is provided



Block Diagram

FEATURES

- Up to 13V Input Voltage
- 5V, 12V, 15V Output Options
- 2A Continuous Output Current
- Open Design Files and BOM
- 600kHz Fixed Frequency
- High Efficiency
- Over-Temperature Protection

ORDERING INFORMATION

| Part Number | Input Voltage (V) | Output Voltage (V) | Output Current (A) |
|--------------|-------------------|--------------------|--------------------|
| MEZD41502A-A | 2.7 - 4.2 | 5 | 2 |
| MEZD41502A-B | 2.7 - 10 | 12 | 2 |
| MEZD41502A-C | 3.4 - 13 | 15 | 2 |

mEZD4150xA-X FAMILY PRODUCTS

| Part Number | Input Voltage (V) | Output Voltage (V) | Output Current (A) |
|--------------|-------------------|--------------------|--------------------|
| mEZD41501A-X | 2.7 - 13 | 5, 12, 15 | 1 |
| mEZD41502A-X | 2.7 - 13 | 5, 12, 15 | 2 |
| mEZD41503A-X | 2.7 - 10 | 5, 12 | 3 |

ELECTRICAL CHARACTERISTICS

| | | |
|-----------------------------|--|--------------------------|
| Input Voltage Range | mEZD41502A-A | 2.7V to 4.2V |
| | mEZD41502A-B | 2.7V to 10V |
| | mEZD41502A-C | 3.4V to 13V |
| Output Voltage Set Accuracy | | ±2.2% |
| Output Voltage Ripple | $V_{IN} = 3.3V, V_{OUT} = 5V, I_{OUT} = 2A$ | 27mV (Typ.) |
| | $V_{IN} = 6.6V, V_{OUT} = 12V, I_{OUT} = 1A$ | 60mV (Typ.) |
| | $V_{IN} = 6.6V, V_{OUT} = 15V, I_{OUT} = 1A$ | 90mV (Typ.) |
| Line Regulation | V_{IN} from MIN to MAX, $I_{OUT} = 1A$ | ±0.3% |
| Load Regulation | I_{OUT} from MIN to MAX, $V_{IN} = 6.6V$ | ±0.5% |
| | $V_{IN} = 3.3V, V_{OUT} = 5V, I_{OUT} = 2A$ | 97.2% |
| Efficiency | $V_{IN} = 6.6V, V_{OUT} = 12V, I_{OUT} = 2A$ | 97.4% |
| | $V_{IN} = 6.6V, V_{OUT} = 15V, I_{OUT} = 2A$ | 96.7% |
| Switching Frequency | Typical switching frequency | 600kHz |
| Short-Circuit Protection | No output short allowed | - |
| Operating Temperature Range | | 0 to 85°C |
| Over-Temperature Protection | OTP | 150°C |
| Calculated MTBF | MIL-HDBK-217F | 4185x10 ³ hrs |

TYPICAL PERFORMANCE CURVES

Power Derating
 $V_{IN} = 3.3V$ and $4.2V$, $V_{OUT} = 5V$

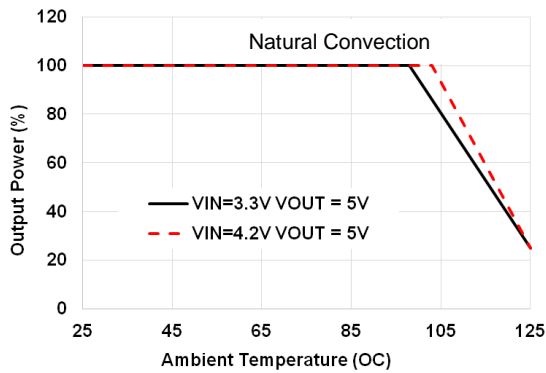

Efficiency vs. Load Current
 $V_{IN} = 3.3V$ and $4.2V$, $V_{OUT} = 5V$

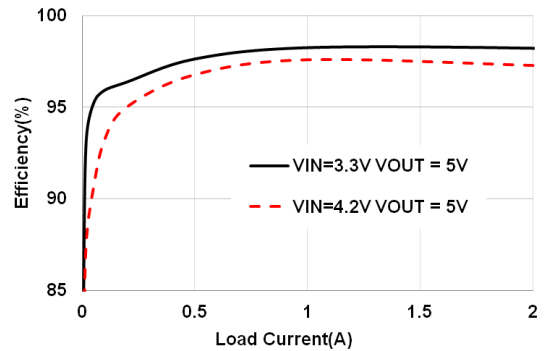

Power Derating
 $V_{IN} = 4.2V$, $6.6V$, and $8.4V$, $V_{OUT} = 12V$

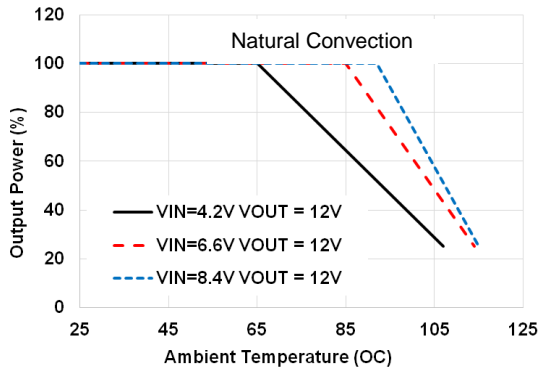

Efficiency vs. Load Current
 $V_{IN} = 4.2V$, $6.6V$, and $8.4V$, $V_{OUT} = 12V$

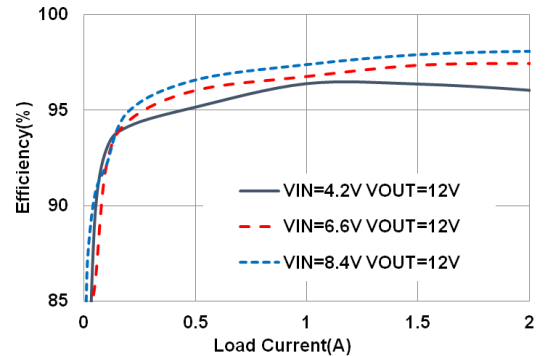

Power Derating
 $V_{IN} = 4.2V$, $6.6V$ and $8.4V$, $V_{OUT} = 15V$

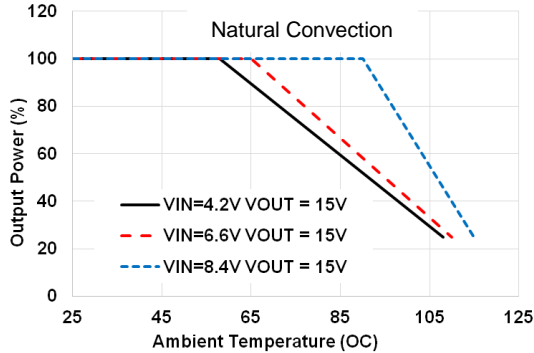

Efficiency vs. Load Current
 $V_{IN} = 4.2V$, $6.6V$ and $8.4V$, $V_{OUT} = 15V$

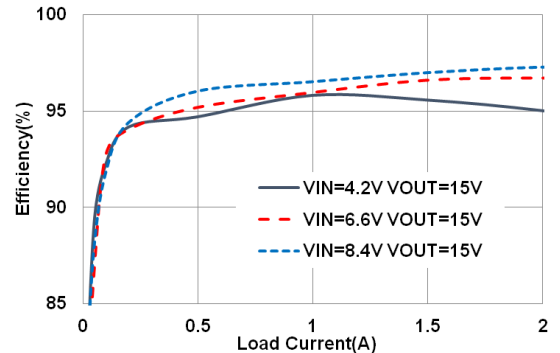

DO-IT-YOURSELF SCHEMATIC



BILL OF MATERIALS

| Item | Qty | RefDes | Value | Description | Package | Manufacturer | Manufacturer P/N |
|------|-----|---------------|------------------------|------------------------------|--------------|--------------|---------------------|
| 1 | 3 | C1A, C1B, C1C | 22µF | Ceramic Cap., 10V, X7R (A) | 1206 | Murata | GRM31CR71A226ME15L |
| | | | | Ceramic Cap., 25V, X7R (B,C) | 1206 | Murata | GRM31ER71E226KE15L |
| 2 | 3 | C2A, C2B, C2C | 22µF | Ceramic Cap., 10V, X7R (A) | 1210 | Murata | GRM32ER71A226KE20L |
| | | | | Ceramic Cap., 25V, X7R (B,C) | 1210 | Murata | GRM32ER71E226KE15L |
| 3 | 2 | C2D, C5 | 100nF | Ceramic Cap., 25V, X7R | 0603 | Murata | GRM188R71E104KA01D |
| 6 | 1 | C3 | 4.7µF | Ceramic Cap., 6.3V, X5R | 0603 | Murata | GRM188R60J475KE19D |
| 5 | 1 | C4 | 22nF | Ceramic Cap., 25V, X7R | 0603 | Murata | GRM188R71E223JA01D |
| 7 | 1 | C6 | 8.2nF(A) 6.8nF(B,C) | Ceramic Cap., 50V, X7R | 0603 | Murata | GRM188R71H822KA01D |
| | | | | | | | GRM188R71H682KA01D |
| 8 | 1 | R1 | 750kΩ | Film Res, 1% | 0603 | YAGEO | RC0603FR-07750KL |
| | | | | | | | 187kΩ(A) |
| 9 | 1 | R2 | 68kΩ(B) 53.6kΩ(C) | Film Res, 1% | 0603 | YAGEO | RC0603FR-0768KL |
| | | | | | | | RC0603FR-0753K6L |
| 10 | 1 | R3 | 3kΩ(A) 10kΩ(B,C) | Film Res, 1% | 0603 | YAGEO | RC0603FR-073KL |
| | | | | | | | RC0603FR-0710KL |
| 11 | 1 | R4 | 30kΩ | Film Res, 1% | 0603 | YAGEO | RC0603FR-0730KL |
| 12 | 1 | R5 | 34.8kΩ | Film Res, 1% | 0603 | YAGEO | RC0603FR-0734K8L |
| 13 | 0 | R6, R7 | NC | | | | |
| 14 | 1 | L1* | 1.5µH | Irms = 19A, RDC = 3.3mΩ | 11.5x10mm | Sumida | 104CDMCCDS-1R5MC-ND |
| 15 | 0 | S1 | NC | | | | |
| 16 | 1 | U1 | MP3429 | Boost Converter | QFN 3x4mm | MPS | MP3429GL |
| 17 | 1 | VIN,VOUT,GND | Connector | 6-Pin Connector | 2.54mm | Würth | |

NOTE: A, B, C denote this value is specifically for mEZD41502A-A, mEZD41502A-B, mEZD41502A-C respectively.

* Or equivalent

PRODUCT PACKAGE AND DIMENSIONS

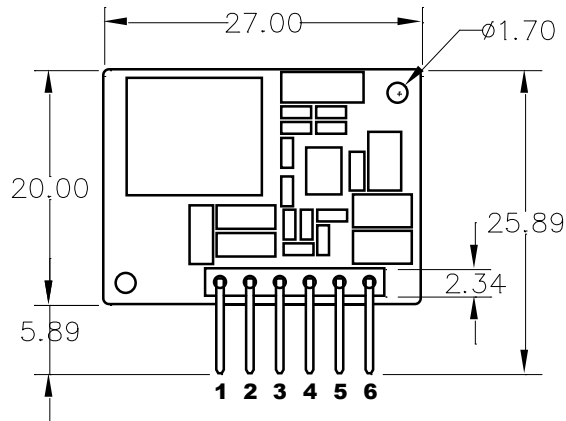

TOP VIEW

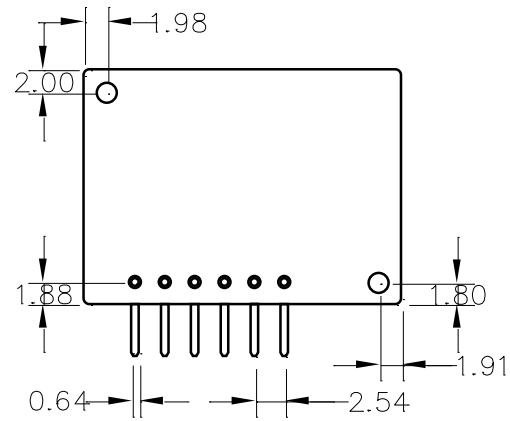

BOTTOM VIEW

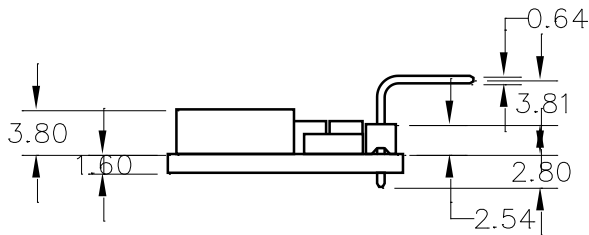

SIDE VIEW

| Pin | Designation | Function |
|------|-------------|----------------|
| 1, 2 | VIN | Input Voltage |
| 3, 4 | GND | Power Ground |
| 5, 6 | VOUT | Output Voltage |

NOTE:

Contact factory for different sizes of the boards (Quantity >2k).

For more information, Gerber files, and PCB layout, please contact mEZsupport@monolithicpower.com