

MODEL TSC - TEMPERATURE SETPOINT CONTROLLER



- SETPOINT PROGRAM CONTROLLER FOR TIME VS. TEMPERATURE (RAMP/SOAK) AND SPECIAL BATCH/RECIPE APPLICATIONS
- ADVANCED PROGRAM PROFILING IN A 1/8 DIN PACKAGE
- ON-LINE MONITORING AND CONTROL OF PROGRAM STATUS, TIME, AND SETPOINT VALUE (Program Run, Pause, Stop, Advance, Modify Time, & Setpoint Value)

- AUTOMATIC PROGRAM DELAY FOR PROFILE CONFORMITY, PLUS PROGRAM LINKING, REPEATING AND AUTO POWER-ON FUNCTIONS FOR ENHANCED CAPABILITY
- DUAL EVENT OUTPUTS FOR TIMED ACTIVATION OF PROCESS EQUIPMENT SUCH AS STIRRERS, FANS, HEATERS, ETC. (Uses Alarm Output Channels)
- FOUR SETPOINT & PID PARAMETER SETS FOR QUICK RECALL OF SETPOINTS AND/OR GAIN VALUES DURING BATCH OR PROCESS CHANGEOVER
- PROGRAMMABLE USER INPUT FOR CONTROLLER AND SETPOINT PROGRAM CONTROL
- 100 MSEC SAMPLING PERIOD WITH 0.15% ACCURACY
- ON DEMAND AUTO-TUNING OF PID CONTROL SETTINGS
- DUAL LED DISPLAYS FOR SIMULTANEOUS INDICATION OF TEMPERATURE AND SETPOINT OR TEMPERATURE AND PROFILE STATUS
- ACCEPTS ANY ONE OF 10 DIFFERENT TYPES OF SENSOR INPUTS (Thermocouple or RTD)
- FIELD REPLACEABLE AND INTERCHANGEABLE OUTPUT MODULES (Relay, Logic/SSR drive, and Triac)
- OPTIONAL DUAL ALARM OUTPUTS (Uses Output Modules)
- OPTIONAL COOLING OUTPUT (Uses Output Module)
- OPTIONAL LINEAR 4 to 20 mA or 0 to 10 VDC OUTPUT FOR CONTROL OR TEMPERATURE RE-TRANSMISSION
- OPTIONAL RS485 SERIAL COMMUNICATIONS INTERFACE
- OPTIONAL TYPE 4X/IP65 SEALED FRONT BEZEL

DESCRIPTION

The TSC is a setpoint controller suitable for time vs. temperature, process control applications. The TSC accepts signals from a variety of temperature sensors (thermocouple and RTD elements), precisely displays the process temperature, and provides an accurate output control signal (time proportional or linear) to maintain a process at the desired control point. A comprehensive set of easy to use steps allows the controller to satisfy various applications. The user input can be programmed to perform a variety of controller functions.

Dual 4-digit displays allow viewing of the measured temperature value and setpoint or temperature and profile status simultaneously. Front panel indicators inform the operator of controller status and output states. Replaceable output modules (Relay, logic/SSR drive or Triac) can be fitted to the main control output, alarm output(s) or timed event output(s), and cooling output.

The TSC has been designed to simplify the set-up and operation of a controlled setpoint profile program. The setpoint program is easily entered and controlled through the front panel. Full display capabilities keep the operator informed of the process temperature, profile status, output states, and setpoint value.

The controller can operate in the standard PID control mode for both heating or cooling with on-demand auto-tune which establishes the PID gain set. The PID gain set can be fine tuned by the operator at any time or may be locked from further modification. The unit can be transferred to the manual control mode providing the operator with direct control of the output.

The TSC features four programs or profile recipes, each with up to eight ramp/soak segments, which can be easily stored and executed at any time. Longer profiles can be achieved by linking one or more profiles together, creating a single profile of up to 32 ramp/soak segments. Temperature profile conformity is assured during either soak (hold) phases or both ramp and hold phases by an adjustable error band parameter. The program repeat function cycles the profile either continuously or a set number of times. Power-on options automatically re-start, stop, or resume a running profile. The profile can be controlled via the front panel buttons, the user input, or the optional serial communications port.

Four control points, each having a setpoint and PID parameter set, are available for instant front panel implementation during batch changeover, or

DIMENSIONS In inches (mm)

Note: Recommended minimum clearance (behind the panel) for mounting clip installation is 5.5" (140) H x 2.1" (53.4) W.

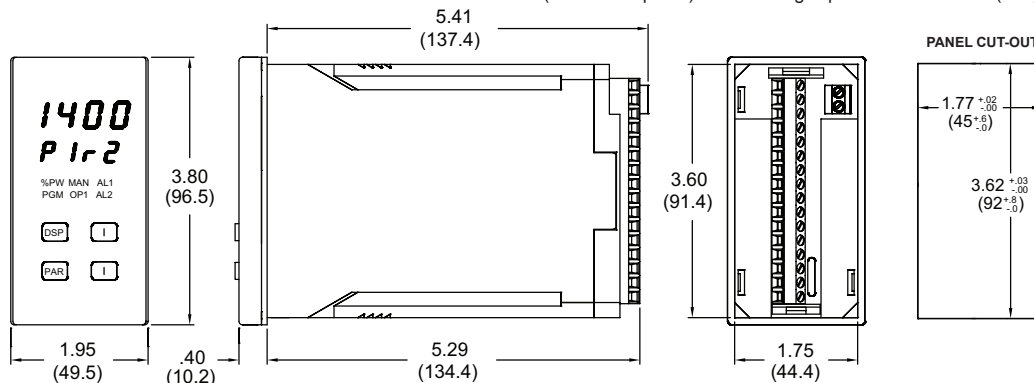

DESCRIPTION (Cont'd)

other process conditions. A control point may have its PID gain set values disabled when implementing the control point.

The optional RS485 multidrop serial communications interface provides the capability of two-way communication between a TSC unit and other compatible equipment such as a printer, a programmable controller, or a host computer. In multipoint applications the address number of each unit on the line can be programmed from 0-99. Up to thirty-two units can be installed on a single pair of wires. The Setpoint value, % Output Power, Setpoint Ramp Rate, etc. can be interrogated or changed by sending the proper command code via serial communications. Alarm output(s) may also be reset via the serial communications interface option.

Optional alarm output(s) may be configured to operate as a timed event output or as a standard alarm output. As an alarm output it may be configured to activate according to a variety of actions (Absolute HI or LO, Deviation HI or LO, or Band IN or OUT) with adjustable hysteresis. Also, a standby feature suppresses the output(s) on power-up until the temperature stabilizes outside the alarm region. Timed event output(s) allow the controller to activate other equipment while a programmed profile is running. Each profile can define up to 16 event states (phases), for each output(s).

An optional secondary output is available for processes that require cooling which provides increased control accuracy and response.

The optional linear 4 to 20 mA or 0 to 10 VDC output signal is available to interface with final actuators, chart recorders, indicators, or other controllers. The output signal can be digitally scaled and selected to transmit one of the following:

- % Output Power
- Measurement Value
- Measurement Value Deviation
- Setpoint Value

An optional Type 4X/IP65 rated bezel is available for washdown and/or dirty environments, when properly installed. Modern surface-mount technology, extensive testing, plus high immunity to noise interference, makes the controller extremely reliable in industrial environments.

SAFETY SUMMARY

All safety related regulations, local codes and instructions that appear in the manual or on equipment must be observed to ensure personal safety and to prevent damage to either the instrument or equipment connected to it. If equipment is used in a manner not specified by the manufacturer, the protection provided by the equipment may be impaired.

Do not use the TSC to directly command motors, valves, or other actuators not equipped with safeguards. To do so, can be potentially harmful to persons or equipment in the event of a fault to the unit. An independent and redundant temperature limit indicator with alarm outputs is strongly recommended. The indicators should have input sensors and AC power feeds independent from other equipment.

SPECIFICATIONS

1. DISPLAY: Dual 4-digit

Upper Temperature Display: 0.4" (10.2 mm) Red LED

Lower Auxiliary Display: 0.3" (7.6 mm) Green LED

Display Messages:

- "LOL" - Appears when measurement exceeds + sensor range.
- "ULUL" - Appears when measurement exceeds - sensor range.
- "OPEN" - Appears when open sensor is detected.
- "SHrt" - Appears when shorted sensor is detected (RTD only).
- "...." - Appears when display value exceeds + display range.
- "..." - Appears when display value exceeds - display range.

2. POWER: Switch selectable for 115/230 VAC (+10%, -15%) no observable line variation effect, 48-62 Hz, 10 VA.

3. ANNUNCIATORS:

6 LED Backlight Status Indicators:

- %PW - Lower auxiliary display shows power output in (%).
- PGM - Lower auxiliary display shows profile status or profile time remaining.
- MAN - Controller is in manual mode.
- OP1 - Main control output is active.
- AL1 - Alarm #1 is active.
- AL2 - Alarm #2 is active (for Dual Alarm Option)
- OP2 - Cooling output is active (for Cooling Option).

4. CONTROLS: Four front panel push buttons for setup and modification of controller functions and one external input.

5. SETPOINT PROFILE:

Profiles: 4

Segments Per Profile: 8 ramp/hold segments (linkable to 32 segments).

Ramp Rate: 0.1 to 999.9 degrees/minute or no ramp.

Hold Time: Off or from 0.1 to 999.9 minutes, can be extended to 500 hours by linking.

Error Band Conformity: Off or from 1 to 9999 degrees deviation, + value for hold phases, - value for both ramp and hold phases.

Power-On Modes: Stop, auto-start, or profile resume.

Start Mode: Ramps from process temperature.

Program Auto Cycle: 1 to 249, or continuous.

Event Outputs: 2, time activated with profile [uses Alarm output(s)].

Control: Front panel buttons, user input, or RS485 communications.

6. CONTROL POINTS:

Setpoints: 4

PID gain sets: 4

Control: Front panel buttons or user input.

7. SENSOR INPUT:

Sample Period: 100 msec

Response Time: 300 msec (to within 99% of final value w/step input; typically, response is limited to response time of probe).

Failed Sensor Response:

Main Control Output(s): Programmable preset output.

Display: "OPEN".

Alarms: Upscale drive.

DC Linear: Programmable preset output.

Normal Mode Rejection: 40 db @ 50/60 Hz (improves with increased digital filtering).

Common Mode Rejection: 100 db, DC to 50/60 Hz.

Protection: Input overload voltage; 240 VAC @ 30 sec max.

8. THERMOCOUPLE:

Types: T, E, J, K, R, S, B, N or Linear mV.

Input Impedance: 20 MΩ, all types.

Lead Resistance Effect: 20 μV/350 Ω.

Cold Junction Compensation: Less than ±1°C error over 0-50°C ambient temperature range. Disabled for linear mV type.

Resolution: 1°C/F all types, or 0.1°C/F for T, E, J, K, and N only.

9. RTD: 2, 3 or 4 wire, 100 Ω platinum, alpha = 0.00385 (DIN 43760), alpha = 0.003916

Excitation: 0.175 mA

Resolution: 1 or 0.1 degree

Lead Resistance: 7 Ω max.

10. RANGE AND ACCURACY:

Errors include NIST conformity and A/D conversion errors at 23°C after 20 minutes warm-up. Thermocouple errors include cold junction effect. Errors are expressed as ±(% of reading) and ±3/4 LSD unless otherwise noted.

TC TYPE	RANGE	ACCURACY	WIRE COLOR (ANSI)
T	-200 to +400°C -328 to +752°F	0.20% + 1.5°C 0.20% + 2.7°F	blue
E	-200 to 750°C -328 to +1382°F	0.20% + 1.5°C 0.20% + 2.7°F	violet
J	-200 to +760°C -328 to +1400°F	0.15% + 1.5°C 0.15% + 2.7°F	white
K	-200 to +1250°C -328 to +2282°F	0.20% + 1.5°C 0.20% + 2.7°F	yellow
R	0 to +1768°C +32 to +3214°F	0.15% + 2.5°C 0.15% + 4.5°F	black
S	0 to +1768°C +32 to +3214°F	0.15% + 2.5°C 0.15% + 4.5°F	black
B	+200 to +1820°C +300 to +3300°F	0.15% + 2.5°C 0.15% + 4.5°F	grey
N	-200 to +1300°C -328 to +2372°F	0.20% + 1.5°C 0.20% + 2.5°F	orange
mV	-5.00 to 56.00	0.15% + 1 LSD	—
RTD (385)	-200 to +600°C -328 to +1100°F	0.10% + 0.5°C 0.10% + 0.9°F	—
RTD (392)	-200 to +600°C -328 to +1100°F	0.10% + 0.5°C 0.10% + 0.9°F	—
OHMS	1.0 to 320.0	0.15% + 1 LSD	—

11. OUTPUT MODULES [Optional] (For All Output Channels):

Relay:

Type: Form-C (Form-A with RS485 option)

Rating: 5 Amps @ 120/240 VAC or 28 VDC (resistive load), 1/8 HP @ 120 VAC (inductive load).

Life Expectancy: 100,000 cycles at max. rating. (Decreasing load and/or increasing cycle time, increases life expectancy).

Logic/SSR Drive: Can drive multiple SSR Power Units.

Type: Non-isolated switched DC, 12 VDC typical.

Drive: 45 mA max.

Triac:

Type: Isolated, Zero Crossing Detection.

Ratings:

Voltage: 120/240 VAC

Max Load Current: 1 AMP @ 35°C
0.75 AMP @ 50°C

Min Load Current: 10 mA

Off State Leakage Current: 7 mA max. @ 60 Hz

Operating Frequency: 20 to 500 Hz

Protection: Internal Transient Snubber, Fused.

SPECIFICATIONS (Cont'd)

12. MAIN CONTROL OUTPUT (Heating or Cooling):

Control: PID or ON/OFF.

Output: Time proportioning or linear DC.

Hardware: Plug-in, replaceable output modules.

Cycle time: Programmable.

Auto-tune: When performed, sets proportional band, integral time, and derivative time values.

Probe Break Action: Programmable.

13. COOLING OUTPUT (Optional):

Control: PID or ON/OFF.

Output: Time proportioning or linear DC

Hardware: Plug-in, replaceable output modules.

Cycle time: Programmable.

Proportional Gain Adjust: Programmable.

Heat/Cool DeadBand: Programmable.

14. LINEAR DC DRIVE (Optional):

With digital scale and offset, programmable deadband and update time.

4 to 20 mA:

Resolution: 1 part in 3500 typ.

Accuracy: $\pm(0.1\%$ of reading + 25 μA).

Compliance: 10 V (500 Ω max. loop impedance).

0 to 10 VDC:

Resolution: 1 part in 3500 typ.

Accuracy: $\pm(0.1\%$ of reading + 35 mV).

Min. Load Resistance: 10 K Ω (1 mA max.)

Source: % output power, setpoint, deviation, or temperature.
(Available for heat or cool, but not both.)

15. ALARMS (Optional):

Hardware: Plug-in, replaceable output module.

Modes: Absolute high acting

Absolute low acting

Deviation high acting

Deviation low acting

Inside band acting

Outside band acting

Timed event output(s)

Reset Action: Programmable; automatic or latched.

Delay: Programmable; enable or disable.

Hysteresis: Programmable.

Probe Break Action: Upscale.

Annunciator: LED backlight for "AL1", "AL2", (Alarm #2 not available with cooling output).

16. SERIAL COMMUNICATIONS (Optional):

Type: RS485 Multi-point, Balanced Interface.

Communication Format:

Baud Rate: Programmable from 300-9600.

Parity: Programmable for odd, even, or no parity.

Frame: 1 start bit, 7 data bits, 1 or no parity bit, 1 stop bit.

Unit Address: Programmable from 0-99, max. of 32 units per line.

Transmit Delay: 100 msec min., 200 msec max.

RS485 Common: Isolated from signal input common.

Auto Print Time: Off to 9999 seconds between print-outs.

17. USER INPUT:

V_{IN} max = 5.25 VDC, V_{IL} = 0.85 V_{MAX} ; V_{IH} = 2.0 V_{MIN} ;
Response time 100 msec max.

Functions:

Program Lock

Print Request

Integral Action Lock

Load Control Point

Auto/Manual Transfer

Run/Hold Profile 1

Setpoint Ramp Select

Run/Stop Profile 1

Reset Alarms

18. ENVIRONMENTAL CONDITIONS:

Operating Temperature: 0 to 50°C

Storage Temperature: -40 to 80°C

Vibration to IEC 68-2-6: Operational 5-150 Hz, 1 g

Shock to IEC 68-2-27: Operational 5 g

Operating and Storage Humidity: 85% max. (non-condensing) from 0°C to 50°C.

Span Drift: \leq 100 ppm/°C

Zero Drift: \leq 1 μ V/°C

Altitude: Up to 2000 meters

19. CERTIFICATIONS AND COMPLIANCES:

CE Approved

EN 61326-1 Immunity to Industrial Locations

Emission CISPR 11 Class A

EN 61010-1

RoHS Compliant

UL Recognized Component: File #E156876

UL Listed: File #E137808

Type 2 Enclosure rating (Face only) for TSC0

Type 4X/IP65 Enclosure rating (Face only) for TSC1

Refer to EMC Installation Guidelines section of the manual for additional information.

20. CONNECTION:

Jaw-type terminal block.

21. CONSTRUCTION:

Front Panel: Flame and scratch resistant tinted plastic.

Case: High impact black plastic. (Mounting collar included).

Type 4X/IP65 model only: Sealed bezel utilizing 2 captive mounting screws (panel gasket included). This unit is rated for Type 4X/IP65 indoor use. Installation Category II, Pollution Degree 2.

22. WEIGHT:

1.3 lbs. (0.6 kgs)

BASIC OPERATION

The TSC controls the temperature profile of a system by measuring the temperature via an input probe, compares the actual temperature to the setpoint profile in progress, and calculates the new output power value by use of a modified PID control algorithm. The unit controls the system with the new output power value so the process temperature conforms to the programmed profile. The PID control algorithm incorporates features which provide minimum overshoot and excellent temperature control accuracy for a process.

FRONT PANEL FEATURES

In the normal display mode, the unit will display the process temperature in the upper display. One of five other parameters may be selected for viewing in the lower display:

Target Setpoint	Profile Phase Time Remaining
% Output Power	Temperature Symbol (F/C)
Profile Status	

The program profile status display indicates the active profile number with the current ramp or hold phase of the profile. The profile can be started, stopped, advanced, etc. from the front panel when the profile status display is viewed, if not locked from access.

The phase time remaining display, shows the time remaining in a ramp or hold phase and, if not locked from access, may be changed on-line to effect temporary changes to the program. Additionally, the target setpoint and % output power (manual mode only) may also be changed on-line or locked from operator access.

From the normal operating mode, parameters are selected by use of the PAR button and modified by use of the UP and DOWN buttons. Parameters are then entered by the PAR button, which advances the user to the next parameter. Pressing the DSP button immediately returns the controller to the normal operating mode from any parameter module. The controller configuration and parameter settings are stored in an internal E²PROM device.

CONFIGURATION MODE

The configuration modules serve to provide the basic set-ups required by the controller. It is divided into sections which group together related programming steps, such as inputs, outputs, alarms, etc. Upon completion of each section, the program returns to the configuration selection stage, which allows the user to return to the normal display mode, or advance to a later configuration stage.

Configuration 1, Inputs

- "TYPE" - Select input probe type
- "SCAL" - Select temperature scale
- "dCPT" - Select temperature resolution
- "FLtr" - Select degree of input filtering
- "SPAN" - Enter input correction span (slope)
- "SHFt" - Enter input correction shift (offset)
- "SPLO" - Enter setpoint lower limit
- "SPHI" - Enter setpoint higher limit
- "SPrP" - Enter setpoint ramp rate
- "InPt" - Select user input function

Configuration 2, Outputs

- "CYCt" - Enter time proportioning cycle time
- "OPAC" - Select control action
- "OPLO" - Enter output power low limit
- "OPHI" - Enter output power high limit
- "OPFL" - Enter probe fail power preset
- "CHYS" - Enter ON/OFF control hysteresis
- "tcoD" - Select auto-tuning damping
- "ANAS" - Select linear DC output assignment *
- "ANLO" - Enter linear DC low scaling value *
- "ANHI" - Enter linear DC high scaling value *

Configuration 3, Parameter lock-outs

- "SP" - Select degree of setpoint access
- "OP" - Select degree of power access
- "P-CS" - Select degree of profile status access
- "P-tr" - Select degree of phase time remaining access
- "UdSP" - Enable temperature units display
- "CodE" - Enter parameter access code
- "Pld" - Select degree of PID access
- "AL" - Select degree of alarm access *
- "ALrS" - Enable manual reset of alarms *
- "CPAC" - Enable control point access
- "PrAC" - Enable ramp/hold program access
- "trnF" - Enable automatic/manual transfer
- "tUNE" - Enable auto-tune invocation

Configuration 4, Alarms *

- "Act 1" - Select operation mode of alarm #1
- "rSt1" - Select reset mode of alarm #1
- "Stb1" - Enable activation delay of alarm #1
- "AL-1" - Enter value for alarm #1
- "Act2" - Select operation mode of alarm #2
- "rSt2" - Select reset mode of alarm #2
- "Stb2" - Enable activation delay of alarm #2
- "AL-2" - Enter value for alarm #2
- "AHYS" - Enter hysteresis value for both alarms

Configuration 5, Cooling *

- "CYC2" - Enter cooling time proportioning cycle time
- "GAN2" - Enter cooling relative gain
- "db-2" - Enter heat/cool deadband or overlap

Configuration 6, Serial Communications *

- "bAUd" - Select baud rate
- "PArb" - Select parity bit
- "Addr" - Enter unit address number
- "Abrv" - Select abbreviated or full mnemonic transmissions
- "PrAt" - Enter automatic print rate
- "PoPt" - Select parameters to be included in print-out

Configuration 7, Control Points

- "CSEt" - Select control point number for set-up 1, 2, 3, & 4
- "SP-x" - Enter setpoint value for selected control point
- "Pld" - Select if PID gain set to be loaded with setpoint
- "PB-x" - Enter proportional band for selected control point *
- "It-x" - Enter integral time for selected control point *
- "dt-x" - Enter derivative time for selected control point *

Configuration 8, Profiles

- "PSEt" - Select profile or event output for set-up 1, 2, 3, or 4
- "PnCC" - Enter program-repeat cycle count for selected profile
- "PnLn" - Select link option for selected profile
- "PnEb" - Enter error band for temperature conformity for selected profile
- "PnPC" - Enter power-down resume status for selected profile
- "Pnr1" - Enter ramp rate 1 for selected profile *
- "PnL1" - Enter setpoint level 1 for selected profile *
- "PnH1" - Enter hold time 1 for selected profile *
-
- "Pnr8" - Enter ramp rate 8 for selected profile *
- "PnL8" - Enter setpoint level 8 for selected profile *
- "PnH8" - Enter hold time 8 for selected profile *
- "Pn 1" - Select event outputs at phase 1 for selected profile *
-
- "Pn16" - Select event outputs at phase 16 for selected profile *

Configuration 9, Factory Service Operations

(Detailed in the operator's manual)

* These parameters may not appear due to option configuration or other programming

HARDWARE FEATURES

The fast 100 msec input sampling rate provides quick controller response to a process disturbance for excellent temperature control. Measurement accuracy of 0.15% provides closer process control conforming to the desired control setpoint value.

The unit accepts a variety of both thermocouple or RTD temperature probes. The A.C. input power is switch selectable, allowing the unit to operate from either 115 VAC or 230 VAC. Since the controller is serviceable from the front of the panel, the output modules may be easily changed or replaced without disturbing the wiring behind the panel and NO re-programming is required. The standard model simply requires pressing a latch to remove the unit. The Type 4X/IP65 rated model utilizes two panel securing screws and a neoprene gasket to guarantee a water tight seal, when properly installed.

Low-drift, highly stable circuit design ensures years of reliable and accurate temperature control. The recommended two year re-calibration interval is easily accomplished via the programming menu.

Type 4X/IP65 BEZEL

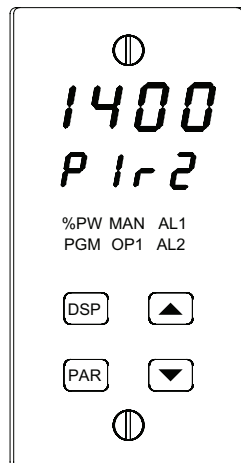

SETPOINT FEATURES

The controller's setpoint can be protected from out of range values, by programming the setpoint range limit values. Additionally, safeguards from inadvertent data entry can also be programmed.

The setpoint ramp feature ramps the setpoint value at start-up or any time a setpoint change is made, at a user programmable rate, independent of a programmed profile. This feature reduces thermal shock to the process and also helps to minimize temperature overshoot.

The active setpoint, which can be a running profile, may also be transmitted by the linear DC output for slave control loops.

Four control points are available which can be implemented at any time. Each control point is programmed independently, with each having a setpoint and a PID gain set value. With gain value changes, the output power control signal will not "bump" resulting in a smooth control transition.

INPUT FEATURES

A programmable input filter can be used to stabilize readings from a process with varying or oscillating temperature characteristics, helping to provide better temperature control.

A programmable temperature shift and slope function can be used to compensate for probe errors or to have multiple TSC units indicate the same nominal temperature.

A programmable User Input is available to control a variety of controller functions, such as profile control, auto/manual transfer, serial communication print requests, etc.

OUTPUT FEATURES

Programmable output power limits provide protection for processes where too much power can cause damage. Automatic sensor probe break detection, for fail-safe operation, causes the controller to default to a programmed output power (*upscale or downscale burnout*). With adjustable time proportioning-cycle time and programmable D.C. Linear output, the controller can satisfy a wide variety of output requirements.

During execution of a profile, two independent, timed event outputs are available to control or signal other equipment. The event outputs use the alarm channels.

The RS485 Communication option allows the user to access various controller parameters such as the setpoint, % output power, % proportional band, etc. The controller may be setup to transmit various parameters at a programmable automatic print rate.

AUTO-TUNE

The model TSC has an auto-tune feature which, on demand, automatically determines the PID control parameters for a particular thermal process. After completion of auto-tune, the PID parameters are automatically optimized for that process and loaded into nonvolatile memory. The operator may view and modify the parameters as desired.

Auto-tune may be invoked at start-up, while ramping, or at setpoint, depending on the process requirements. A programmable auto-tune damping factor produces various levels of process control and response characteristics.

PROFILE PROGRAMMING

Profiles are programmed independently of each other and are separate from the configuration of other controller parameters. Each profile has parameters for error band (profile conformity), linking, auto-start and program repeat cycles. Profiles may be altered during execution, so changes take effect as the programmed profile advances.

CONTROLLER PROGRAMMING

The model TSC has been designed to reduce the operator interaction with the controller while still maintaining a high degree of control accuracy and user flexibility. Front panel program disable allows all of the controller's set-ups to be locked-out from further operator intervention after the initial parameter set-up.

The programming of the controller is divided into four sections:

- Hidden Mode
- Protected Mode
- Unprotected Mode
- Configuration Mode

These four programming modes allow the controller to adapt to any required user-interface level.

UNPROTECTED PARAMETER MODE

The unprotected mode is accessible when program disable is inactive or when the proper access code number from the protected mode is entered. Only from this mode can the configuration modes be accessed.

- "SP" - Enter setpoint *
- "OPOF" - Enter %output power offset *
- "OP" - Enter output power *
- "ProP" - Enter proportional band
- "Intt" - Enter integral time *
- "dErt" - Enter derivative time *
- "AL-1" - Enter value for alarm #1 *
- "AL-2" - Enter value for alarm #2 *
- "CNFP" - Select basic configuration module
- "End" - Return to normal display mode

PROTECTED PARAMETER MODE *

The protected mode is accessible when program disable is active, also this mode prevents access to the configuration modes without the proper access code number. Only the parameters that are selected in the configuration 3 parameter lock-outs section can be accessed.

- "ProP" - Enter proportional band
- "Intt" - Enter integral time
- "dErt" - Enter derivative time
- "AL-1" - Enter value for alarm #1
- "AL-2" - Enter value for alarm #2
- "CodE" - Enter access value to unprotected mode
- "End" - Return to normal display mode

HIDDEN FUNCTIONS MODE *

The hidden mode is accessible from the normal operating mode by holding the PAR button for 3 seconds. The five functions in this mode may be locked-out individually in configuration 3 parameter lock-outs section.

- "CP" - Load control point x
- "Prun" - Control ramp/hold profile state
- "trnF" - Transfer between automatic (PID) control and Manual control
- "tUNE" - Invoke/Cancel PID auto-tune
- "ALrS" - Reset latched alarms

OUTPUT VARIATIONS WITHOUT RS485 OPTION

The Dual Alarm or the Cooling with Alarm output, without the RS485 option, has independent outputs. Therefore, the cooling output and/or alarm output(s) can be installed with any combination of output modules.

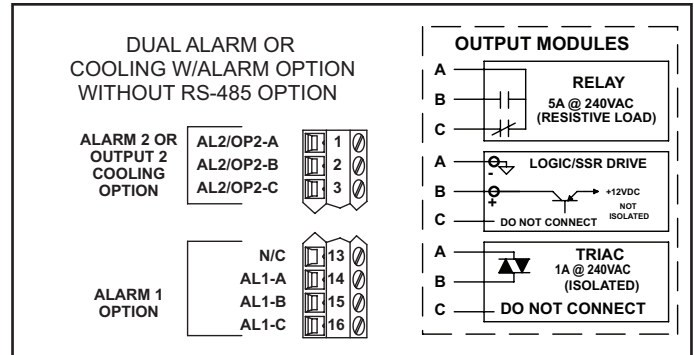

OUTPUT VARIATIONS WITH RS485 OPTION

The Dual Alarm or the Cooling with Alarm output, with RS485 option, does not have independent outputs. In this case, the cooling output and/or alarm output(s) must have the same type of output modules installed since they share the common terminal.

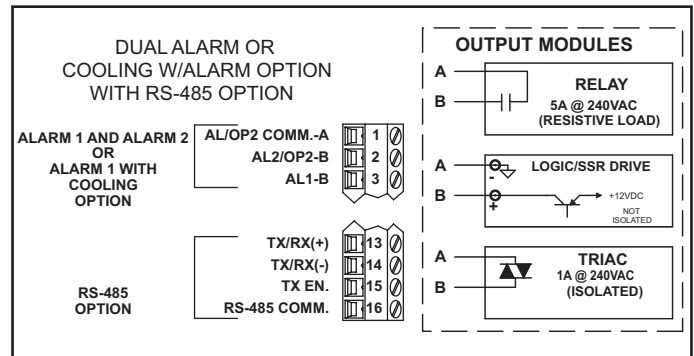

* These parameters may not appear due to option configuration or other programming

OUTPUT MODULES

Units equipped with RS485 option must have the Dual Alarm or Cooling w/ alarm options fitted with the same type of output modules. The controller's main output (OP1) can be fitted with any output module. Output modules are shipped separately and must be installed by the user.

TYPICAL CONNECTIONS

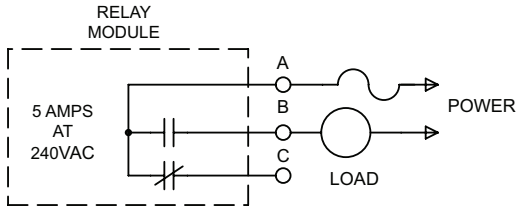

Relay:

Type: Form -C (Form-A with RS485 option only)

Rating: 5 Amps @ 120/240 VAC or 28 VDC (resistive load), 1/8 HP @ 120 VAC (inductive).

Life Expectancy: 100,000 cycles at maximum load rating.

(Decreasing load and/or increasing cycle time, increases life expectancy).

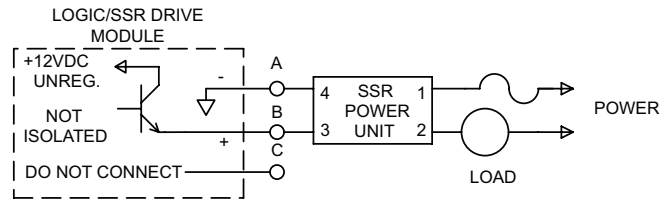

Logic/SSR Drive: can drive multiple SSR Power Units.

Type: Non-isolated switched DC, 12 VDC typical.

Drive: 45 mA max.

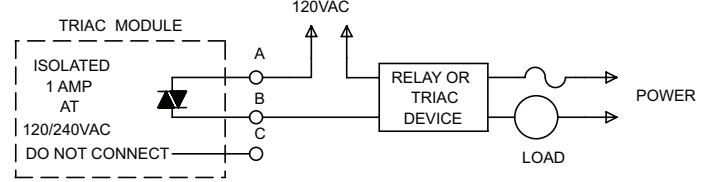

Triac:

Type: Isolated, Zero Crossing Detection.

Rating:

Voltage: 120/240 VAC.

Max. Load Current: 1 Amp @ 35°C

0.75 Amp @ 50°C

Min. Load Current: 10 mA

Off State Leakage Current: 7 mA max. @ 60 Hz

Operating Frequency: 20 to 500 Hz.

Protection: Internal Transient Snubber, Fused.

APPLICATION

TSC GLASS TEMPERING APPLICATION

A manufacturer of glass items needs to anneal (*temper*) their products to reduce the brittleness of the glass structure. The tempering process requires the glass to be heated and subsequently cooled at a controlled rate to change the structure of the glass. Different tempering profiles are required for different types of glass products.

A TSC is employed to control the temperature profile of the annealing oven. Four different temperature profiles are stored in the controller. The 4 to 20 mA analog output option is utilized to cool the annealing oven during the cool down ramp phases. An event output is used to quickly cool the oven at the end of the batch run (*alarm 1*). Alarm 2 is used to signal the operator whenever the temperature is outside the prescribed program profile.

Note: Units equipped with the RS485 option have different terminal designators. See "Output Variations with or without the RS485 Option".

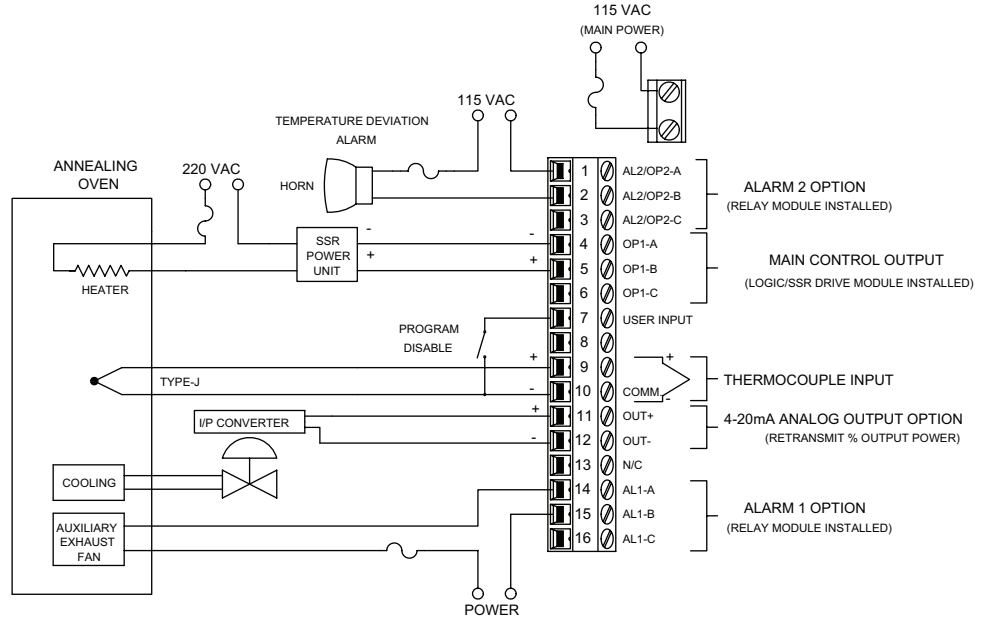

The programming for this profile is as follows:

Parameter	Value	Description
"P1r1"	5.0	Ramp from ambient temp. during heat phase at 5.0°/min.
"P1L1"	300	Target setpoint level 300°
"P1H1"	40.0	Heat at 300° for 40.0 minutes
"P1r2"	3.0	Ramp down 3.0°/min. during cooling phase
"P1L2"	150	Target Setpoint is 150°
"P1H2"	0.0	Do not hold at 150° (used as "phantom" hold time for triggering event output for auxiliary cooling)
"P1r3"	-0.1	End Program
"P1 1"	1F2F	Turn off output 1 (output 2 is alarm)
"P1 2"	1F2F	Keep off output 1
"P1 3"	1F2F	Keep off output 1
"P1 4"	1N2F	Turn on output 1 for Auxiliary Exhaust Fan

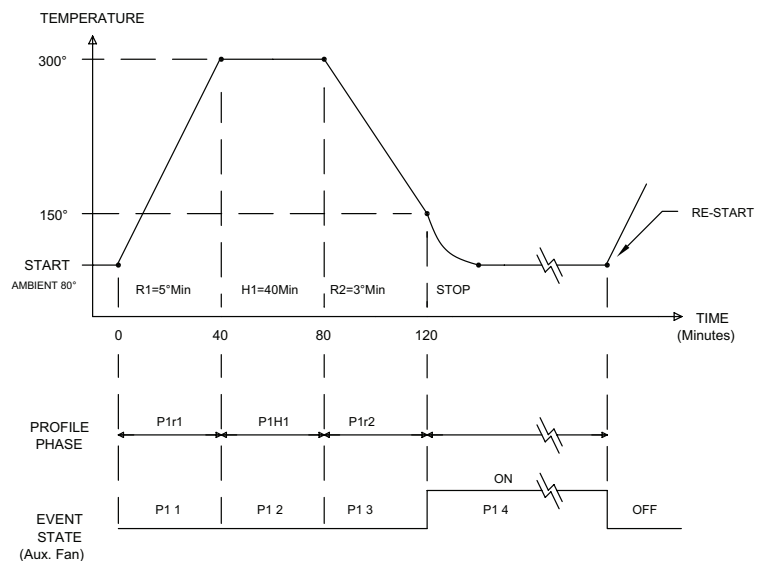

ORDERING INFORMATION

MODEL NO	DESCRIPTION	Type 4X/IP65 BEZEL	4 to 20 mA ANALOG OUTPUT	0 to 10 VDC ANALOG OUTPUT	ALARM OUTPUTS	COOLING OUTPUT	RS485 COM	PART NUMBER
TSC	Temperature Setpoint Controller	NO	YES	NO	2	NO	NO	TSC01001
		YES	YES	NO	2	NO	NO	TSC11001
		YES	YES	NO	1	YES	NO	TSC11002
		YES	YES	NO	2	NO	YES	TSC11004
		YES	YES	NO	1	YES	YES	TSC11005
		YES	NO	YES	2	NO	YES	TSC12004
	Relay Module			YES	1	YES	YES	TSC12005
	Relay Module							OMD00000
	Triac Module							OMD00001
	Logic/SSR Drive Module							OMD00003
PMK5	Panel Mount Adapter Kit (1/4 DIN to 1/8 DIN)							PMK50000
RLY	45 A Single Phase Panel Mount SSR							RLY50000
	25 A Single Phase DIN Rail Mount SSR							RLY60000
	40 A Single Phase DIN Rail Mount SSR							RLY6A000
	25 A Three Phase DIN Rail Mount SSR							RLY70000
These models have dual alarm outputs, or single alarm with secondary outputs, with shared common terminals (Form A Type). As a result, these outputs should be fitted with the same type of output module. The main output (OP1) may be fitted with any type of output								

Note: Output Modules are NOT supplied with the controller. When specifying the controller, be sure to purchase the appropriate output module for the Main Control Output and if necessary, the alarm output(s) and cooling output. The controller can be fitted with any combination of output modules that do not have the RS485 option.

The Logic/SSR Drive Module is a switched DC source, intended to drive the DC input of an SSR power unit. It should never be connected to a line voltage.

All modules are shipped separately and must be installed by the user.

LIMITED WARRANTY

The Company warrants the products it manufactures against defects in materials and workmanship for a period limited to two years from the date of shipment, provided the products have been stored, handled, installed, and used under proper conditions. The Company's liability under this limited warranty shall extend only to the repair or replacement of a defective product, at The Company's option. The Company disclaims all liability for any affirmation, promise or representation with respect to the products.

The customer agrees to hold Red Lion Controls harmless from, defend, and indemnify RLC against damages, claims, and expenses arising out of subsequent sales of RLC products or products containing components manufactured by RLC and based upon personal injuries, deaths, property damage, lost profits, and other matters which Buyer, its employees, or sub-contractors are or may be to any extent liable, including without limitation penalties imposed by the Consumer Product Safety Act (P.L. 92-573) and liability imposed upon any person pursuant to the Magnuson-Moss Warranty Act (P.L. 93-637), as now in effect or as amended hereafter.

No warranties expressed or implied are created with respect to The Company's products except those expressly contained herein. The Customer acknowledges the disclaimers and limitations contained herein and relies on no other warranties or affirmations.

Red Lion Controls
Headquarters
20 Willow Springs Circle
York PA 17406
Tel +1 (717) 767-6511
Fax +1 (717) 764-0839

Red Lion Controls
Europe
Softwareweg 9
NL - 3821 BN Amersfoort
Tel +31 (0) 334 723 225
Fax +31 (0) 334 893 793

Red Lion Controls
India
201-B, 2nd Floor, Park Centra
Opp 32 Mile Stone, Sector-30
Gurgaon-122002 Haryana, India
Tel +91 984 487 0503

Red Lion Controls
China
Unit 302, XinAn Plaza
Building 13, No.99 Tianzhou Road
ShangHai, P.R. China 200223
Tel +86 21 6113 3688
Fax +86 21 6113 3683