

Small, Low Power, Voltage-Output Ambient Light Photo Detect IC

The ISL29101 is a low power ambient Light-to-Voltage optical sensor combining a photodiode array, a current amplifier and a micropower operational amplifier on a single monolithic IC. Similar to the human eye, the photodiode array has a peak response at 550nm and spans from 400nm to 600nm, rejecting UV light and IR light. The output voltage is proportional to the visible light intensity from 0.5 lux up to 10,000 lux. However, the input luminance range can go up to 30,000 lux with some compromise in linearity.

A dark current compensation circuit aids the photodiode array to minimize temperature dependent leakage currents in the absence of light, improving the light sensity at low lux levels.

Housed in an ultra-compact surface mount 2mmx2.1mm ODFN clear plastic package, this device is excellent for power saving control functions in cell phones, PDAs, and other handheld applications.

Ordering Information

PART NUMBER (Notes 2, 3)	TEMP. RANGE (°C)	PACKAGE (Pb-free)	PKG. DWG. #
ISL29101IROZ-T7 (Note 1)	-40 to +85	6 Ld ODFN	L6.2x2.1
ISL29101IROZ-T7A (Note 1)	-40 to +85	6 Ld ODFN	L6.2x2.1
ISL29101IROZ-EVALZ	Evaluation Board		

NOTES:

- Please refer to [TB347](#) for details on reel specifications.
- These Intersil Pb-free plastic packaged products employ special Pb-free material sets; molding compounds/die attach materials and NiPdAu plate - e4 termination finish, which is RoHS compliant and compatible with both SnPb and Pb-free soldering operations. Intersil Pb-free products are MSL classified at Pb-free peak reflow temperatures that meet or exceed the Pb-free requirements of IPC/JEDEC J STD-020.
- For Moisture Sensitivity Level (MSL), please see device information page for [ISL29101](#). For more information on MSL please see tech brief [TB477](#).

Simplified Block Diagram

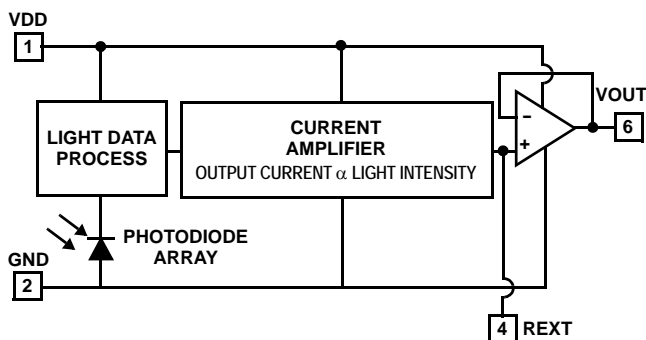

Features

- 0.5 lux to 10,000 lux range
- 1.8V to 3.3V supply range
- Low supply current
- Fast response time
- Excellent linearity of output voltage vs light intensity
- Close to human eye response
- Good IR rejection
- Internal temperature compensation
- Operating temperature range -40°C to +85°C
- Ultra-compact surface mount package
- Pb-free (RoHS compliant)

Applications

- Display and keypad dimming for:
 - Mobile devices: smart phone, PDA, GPS
 - Computing devices: notebook PC, webpod
 - Consumer devices: LCD-TV, digital picture frame, digital camera
- Industrial and medical light sensing

Pinout

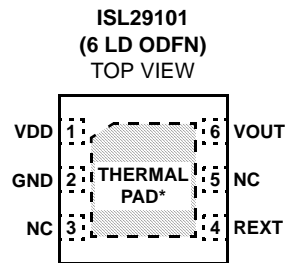

*THERMAL PAD CAN BE CONNECTED TO GND OR ELECTRICALLY ISOLATED

Pin Descriptions

PIN	NAME	DESCRIPTION
1	VDD	Supply. 1.8V to 3.3V
2	GND	Ground
3, 5	NC	No Connect
4	REXT	Connected to an external resistor to GND setting the light-to-voltage proportionality constant.
6	VOUT	Voltage Output

Absolute Maximum Ratings ($T_A = +25^\circ\text{C}$)

Supply Voltage between V_{DD} and GND	3.6V
R_{EXT}	(-0.5V - GND) to (0.5V + V_{DD})
V_{OUT}	(-0.5V - GND) to (0.5V + V_{DD})
V_{OUT} Short Circuit Current	<10mA
ESD Rating	
Human Body Model	3000V
Machine Model	300V

Thermal Information

Thermal Resistance	θ_{JA} ($^\circ\text{C/W}$)
6 Ld ODFN (Note 4)	88
Maximum Die Temperature	+90 $^\circ\text{C}$
Storage Temperature	-40 $^\circ\text{C}$ to +100 $^\circ\text{C}$
Operating Temperature	-40 $^\circ\text{C}$ to +85 $^\circ\text{C}$
Pb-Free Reflow Profile	see link below
	http://www.intersil.com/pbfree/Pb-FreeReflow.asp

CAUTION: Do not operate at or near the maximum ratings listed for extended periods of time. Exposure to such conditions may adversely impact product reliability and result in failures not covered by warranty.

NOTE:

- θ_{JA} is measured in free air with the component mounted on a high effective thermal conductivity test board with "direct attach" features. See Tech Brief [TB379](#).

IMPORTANT NOTE: All parameters having Min/Max specifications are guaranteed. Typical values are for information purposes only. Unless otherwise noted, all tests are at the specified temperature and are pulsed tests, therefore: $T_J = T_C = T_A$

Electrical Specifications $V_{DD} = 3\text{V}$, $T_A = +25^\circ\text{C}$, $R_{EXT} = 100\text{k}\Omega$, no load at V_{OUT} , green LED light, unless otherwise specified.

PARAMETER	DESCRIPTION	CONDITION	MIN (Note 6)	TYP	MAX (Note 6)	UNIT
E	Range of Input Light Intensity			0.5 to 10k		lux
VDD	Power Supply Range		1.8		3.3	V
IDD	Supply Current	E = 1000 lux		23	35	μA
		E = 100 lux		3.5		μA
		E = 0 lux		0.65		μA
VOUT0	Light-to-Voltage Accuracy	E = 100 lux		165		mV
VOUT1	Light-to-Voltage Accuracy	E = 1000 lux	1.15	1.65	2.13	V
VDARK	Voltage Output in the Absence of Light	E = 0 lux, $R_L = 10\text{M}\Omega$		1	25	mV
ΔV_{OUT}	Output Voltage Variation Over Three Light Sources: Fluorescent, Incandescent and Halogen	E = 1000 lux		20		%
PSRR	Power Supply Rejection Ratio	E = 100 lux, $V_{DD} = 1.8\text{V}$ to 3.3V		2.5		mV/V
VO-MAX	Maximum Output Compliance Voltage at 95% of Nominal Output			$V_{DD} - 0.7\text{V}$		V
tR	ISRC and ISNK Rise Time (Note 5)	E = 300 lux from 0 lux		104		μs
		E = 1000 lux from 0 lux		27		μs
tF	ISRC and ISNK Fall Time (Note 5)	E = 300 lux to 0 lux		562		μs
		E = 1000 lux to 0 lux		233		μs
tD	ISRC and ISNK Delay Time for Rising Edge (Note 5)	E = 300 lux from 0 lux		504		μs
		E = 1000 lux from 0 lux		209		μs
tS	ISRC and ISNK Delay Time for Falling Edge (Note 5)	E = 300 lux to 0 lux		30		μs
		E = 1000 lux to 0 lux		18		μs
ISC	Short Circuit Current of Op Amp			± 11		mA
SR	Slew Rate of Op Amp			± 10		V/ms
VOS	Offset Voltage of Op Amp			± 1.2		mV

NOTE:

- Switching time measurement is based on Figures 1 and 2.
- Compliance to datasheet limits is assured by one or more methods: production test, characterization and/or design.

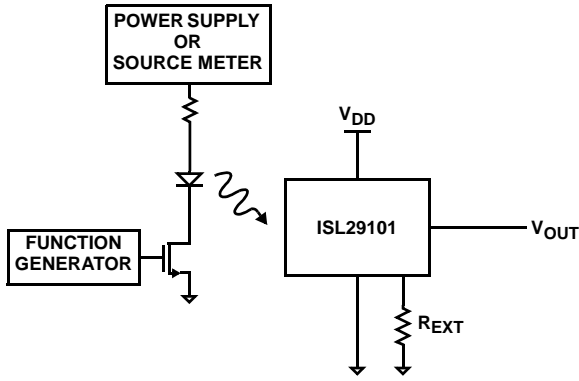

FIGURE 1. TEST CIRCUIT FOR RISE/FALL TIME MEASUREMENT

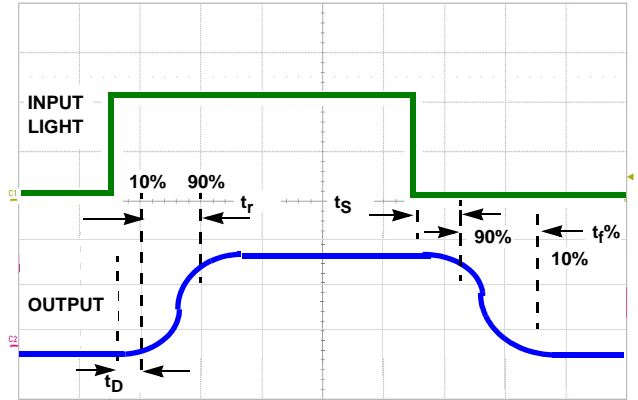

FIGURE 2. TIMING DIAGRAM

Typical Performance Curves

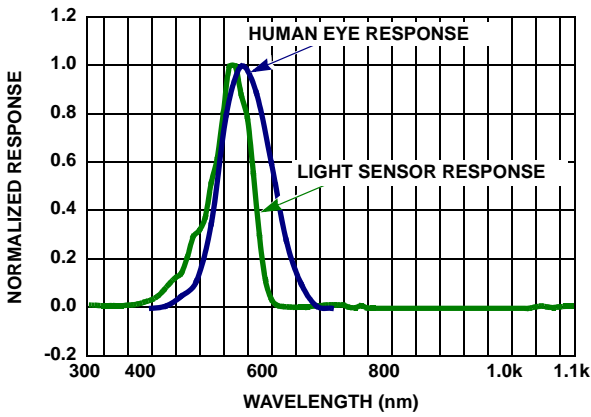

FIGURE 3. SPECTRAL RESPONSE

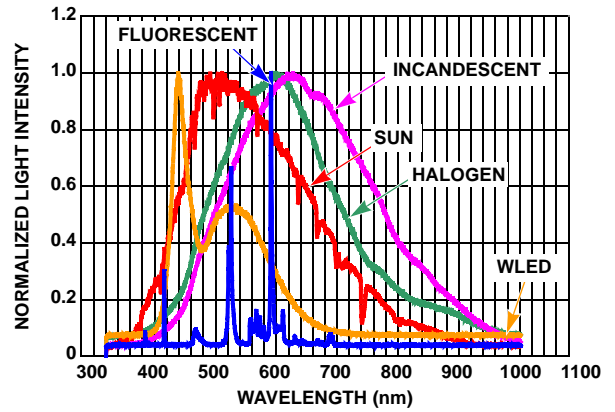

FIGURE 4. SPECTRUM OF LIGHT SOURCES

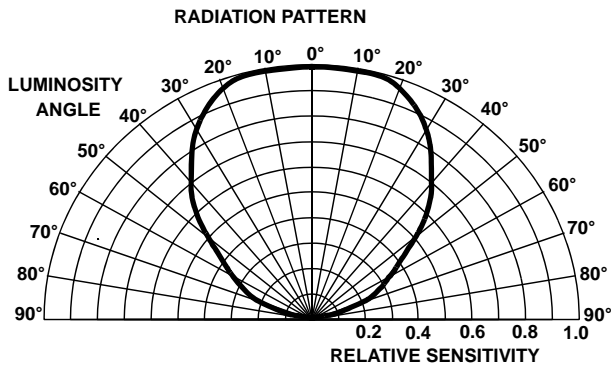

FIGURE 5. RADIATION PATTERN

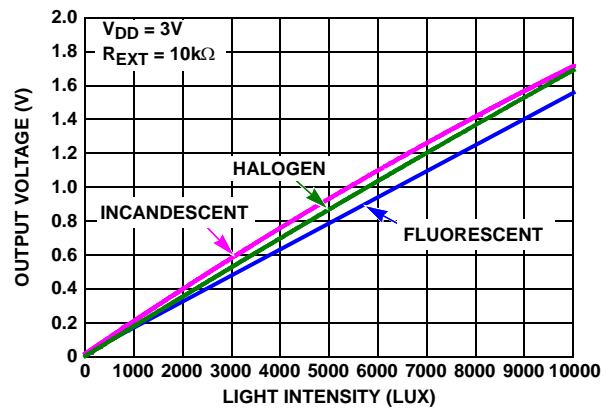

FIGURE 6. OUTPUT VOLTAGE vs LIGHT SENSITIVITY

Typical Performance Curves (Continued)

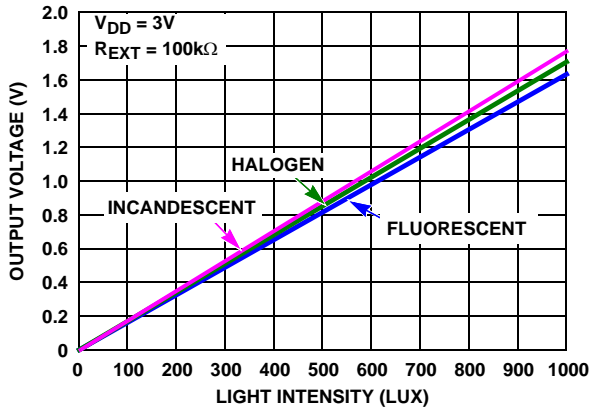

FIGURE 7. OUTPUT VOLTAGE vs LIGHT SENSITIVITY

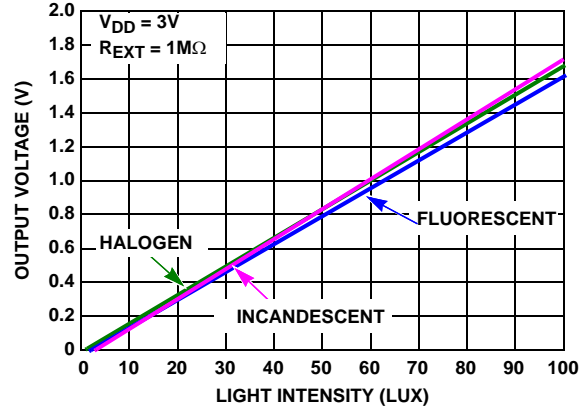

FIGURE 8. OUTPUT VOLTAGE vs LIGHT INTENSITY

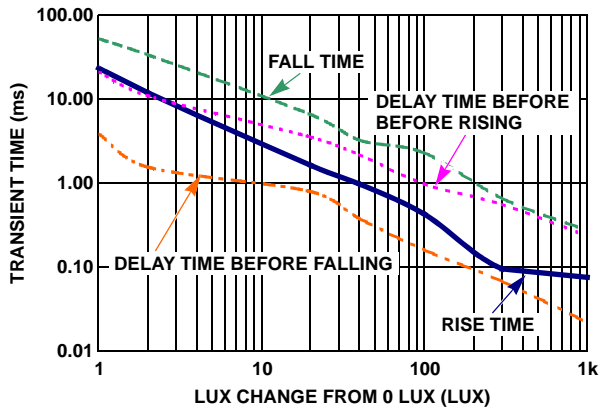

FIGURE 9. TRANSIENT TIME vs LUX CHANGE FROM 0 LUX

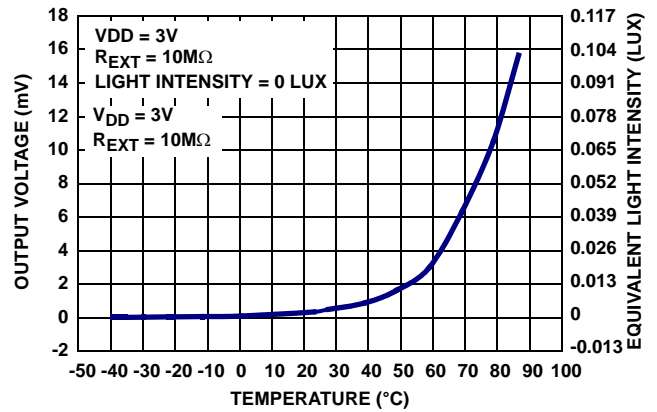

FIGURE 10. OUTPUT VOLTAGE vs TEMPERATURE AT 0 LUX

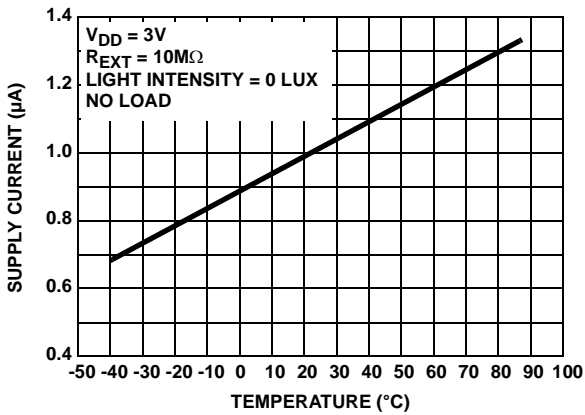

FIGURE 11. SUPPLY CURRENT vs TEMPERATURE AT 0 LUX

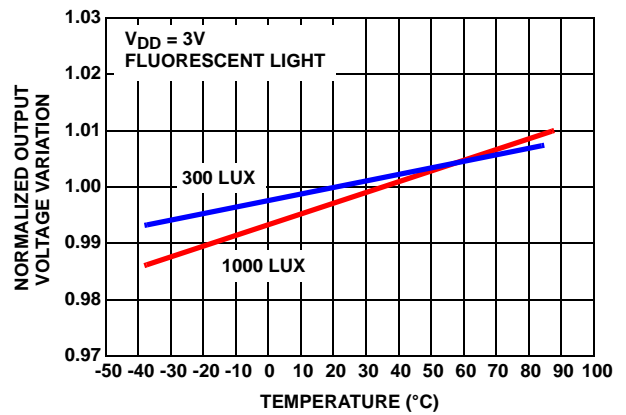

FIGURE 12. NORMALIZED OUTPUT VOLTAGE vs TEMPERATURE

Typical Performance Curves (Continued)

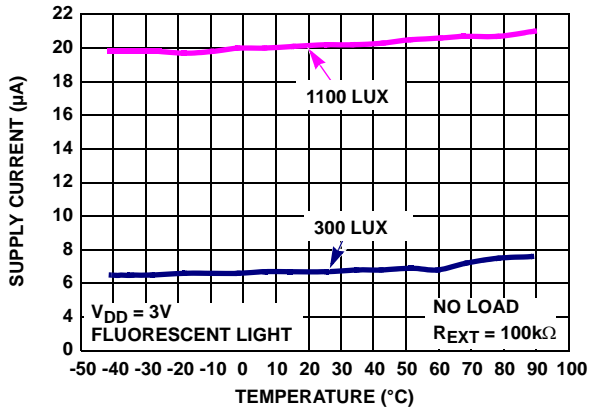

FIGURE 13. SUPPLY CURRENT vs TEMPERATURE

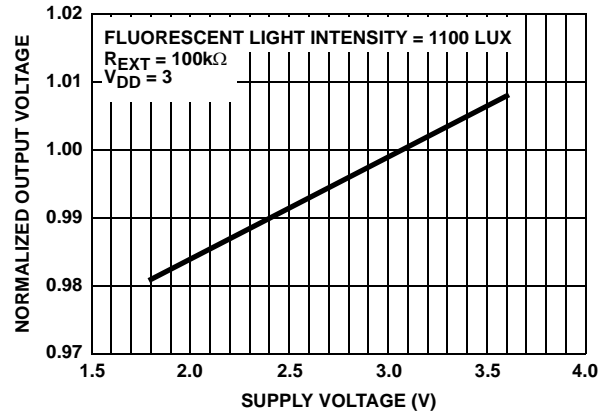

FIGURE 14. NORMALIZED OUTPUT VOLTAGE vs SUPPLY VOLTAGE

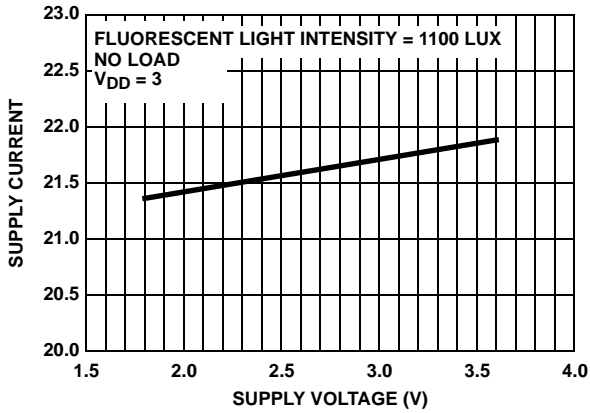

FIGURE 15. SUPPLY CURRENT vs SUPPLY VOLTAGE

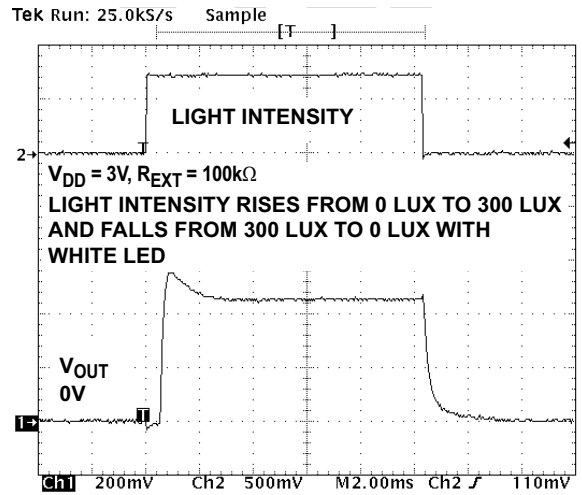

FIGURE 16. TRANSIENT RESPONSE OF ISL29101 TO CHANGE IN LIGHT INTENSITY

Application Information

Light-to-Voltage Conversion

The ISL29101 has responsiveness that is a linear function of the light intensity intercepted by the photodiode in lux. Because the photodiode has a responsivity that resembles the human eye, conversion rate is independent of the light source (fluorescent light, incandescent light or direct sunlight).

$$V_{OUT} = (1.6\mu A/100lux) \cdot E \cdot R_{EXT} \quad (EQ. 1)$$

Here, V_{OUT} is the output voltage and E is the light intensity. R_{EXT} is the value of the external resistor, which is used to set the light-to-voltage scaling constant. The compliance of

the ISL29101's output circuit may result in premature saturation when an excessively large R_{EXT} is used. The output compliance voltage is 700mV below the supply voltage, as listed in V_{O-MAX} of the "Electrical Specifications" table on page 2.

Optical Sensor Location Outline

The green area in Figure 17 shows the optical sensor location outline of ISL29101. Along the pinout direction, the center line (CL) of the sensor coincides with that of the packaging. The sensor width in this direction is 0.39mm. Perpendicular to the pin-out direction, the CL of the sensor has an 0.19mm offset from the CL of packaging away from pin-1. The sensor width in this direction is 0.46mm.

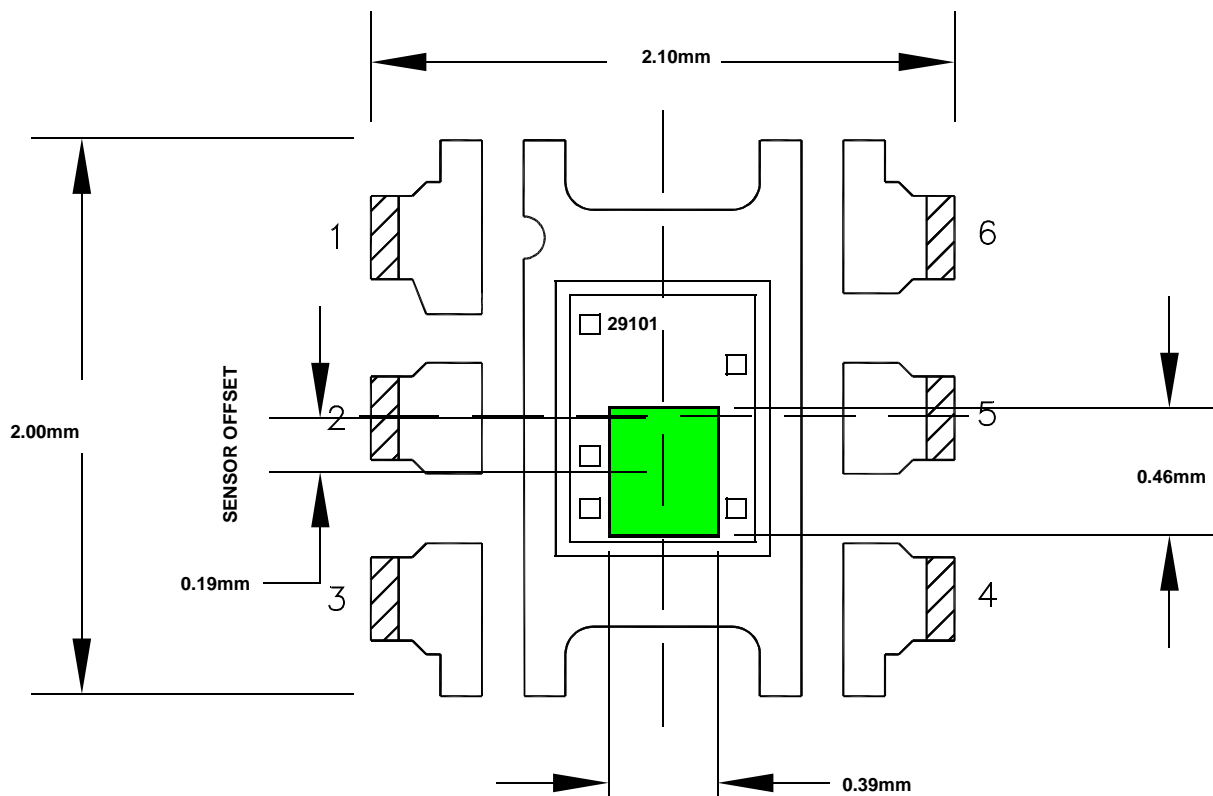

FIGURE 17. 6 LD ODFN SENSOR LOCATION OUTLINE

All Intersil U.S. products are manufactured, assembled and tested utilizing ISO9000 quality systems. Intersil Corporation's quality certifications can be viewed at www.intersil.com/design/quality

Intersil products are sold by description only. Intersil Corporation reserves the right to make changes in circuit design, software and/or specifications at any time without notice. Accordingly, the reader is cautioned to verify that data sheets are current before placing orders. Information furnished by Intersil is believed to be accurate and reliable. However, no responsibility is assumed by Intersil or its subsidiaries for its use; nor for any infringements of patents or other rights of third parties which may result from its use. No license is granted by implication or otherwise under any patent or patent rights of Intersil or its subsidiaries.

For information regarding Intersil Corporation and its products, see www.intersil.com

Package Outline Drawing

L6.2x2.1

6 LEAD OPTICAL DUAL FLAT NO-LEAD PLASTIC PACKAGE (ODFN)

Rev 3, 5/11

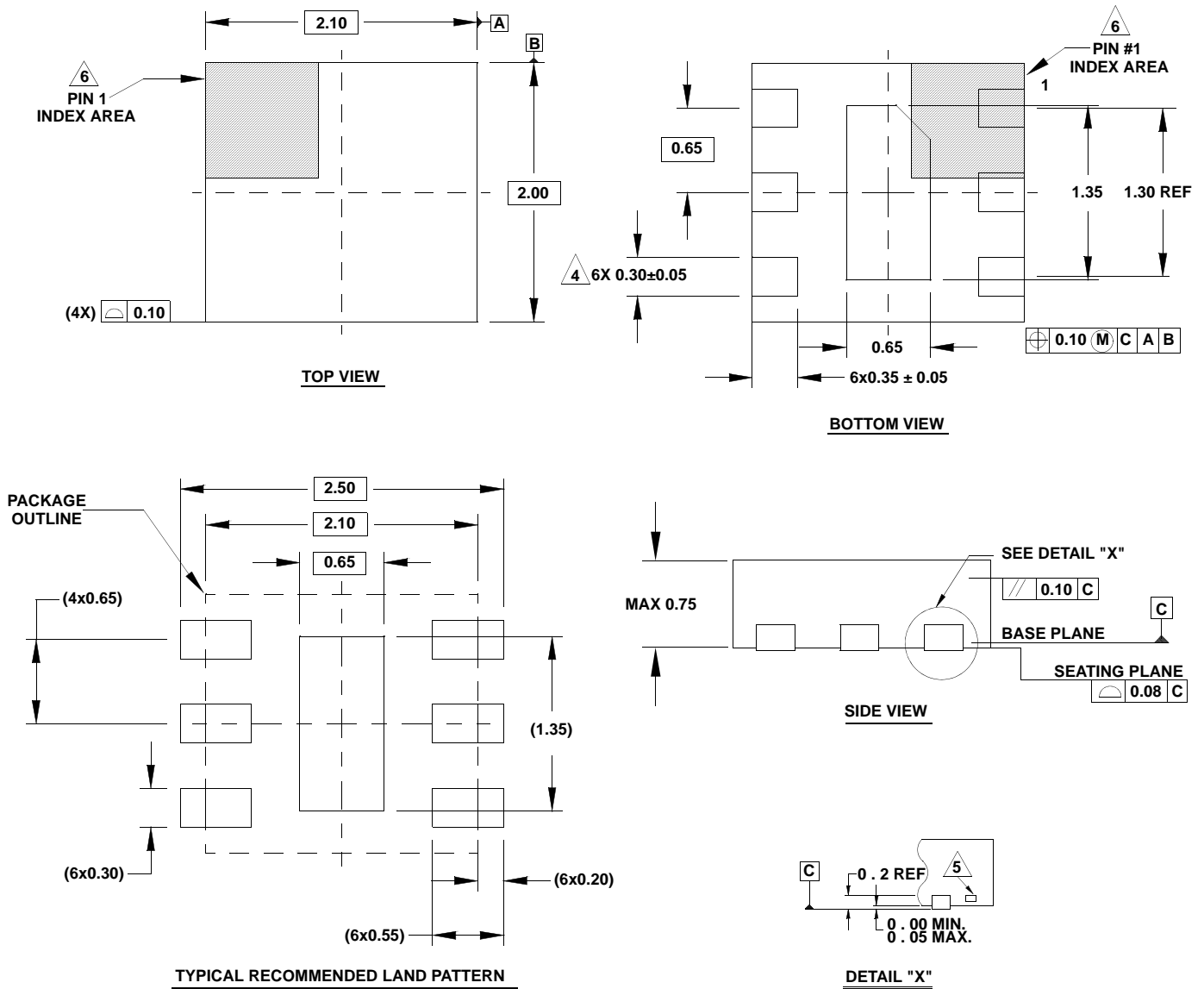

NOTES:

1. Dimensions are in millimeters.
Dimensions in () for Reference Only.
2. Dimensioning and tolerancing conform to ASME Y14.5m-1994.
3. Unless otherwise specified, tolerance : Decimal ± 0.05
4. Dimension applies to the metallized terminal and is measured between 0.15mm and 0.30mm from the terminal tip.
5. Tiebar shown (if present) is a non-functional feature.
6. The configuration of the pin #1 identifier is optional, but must be located within the zone indicated. The pin #1 identifier may be either a mold or mark feature.