

GenX3™ 600V IGBTs w/ SiC Anti-Parallel Diode

IXGA30N60C3C1
IXGP30N60C3C1
IXGH30N60C3C1

$V_{CES} = 600V$
 $I_{C110} = 30A$
 $V_{CE(sat)} \leq 3.0V$
 $t_{fi(typ)} = 47ns$

High-Speed PT IGBTs for
40 - 100kHz Switching

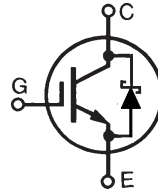

Symbol	Test Conditions	Maximum Ratings	
V_{CES}	$T_C = 25^\circ C$ to $150^\circ C$	600	V
V_{CGR}	$T_J = 25^\circ C$ to $150^\circ C$, $R_{GE} = 1M\Omega$	600	V
V_{GES}	Continuous	± 20	V
V_{GEM}	Transient	± 30	V
I_{C25}	$T_C = 25^\circ C$	60	A
I_{C110}	$T_C = 110^\circ C$	30	A
I_{F110}	$T_C = 110^\circ C$	13	A
I_{CM}	$T_C = 25^\circ C$, 1ms	150	A
SSOA (RBSOA)	$V_{GE} = 15V$, $T_{VJ} = 125^\circ C$, $R_G = 5\Omega$ Clamped Inductive Load	$I_{CM} = 60$ @ $\leq V_{CES}$	A
P_C	$T_C = 25^\circ C$	220	W
T_J		-55 ... +150	$^\circ C$
T_{JM}		150	$^\circ C$
T_{stg}		-55 ... +150	$^\circ C$
T_L	1.6mm (0.062 in.) from Case for 10s	300	$^\circ C$
T_{SOLD}	Plastic Body for 10 seconds	260	$^\circ C$
M_d	Mounting Torque (TO-220 & TO-247)	1.13/10	Nm/lb.in.
Weight	TO-263	2.5	g
	TO-220	3.0	g
	TO-247	6.0	g

Symbol	Test Conditions ($T_J = 25^\circ C$ Unless Otherwise Specified)	Characteristic Values		
		Min.	Typ.	Max.
$V_{GE(th)}$	$I_C = 250\mu A$, $V_{CE} = V_{GE}$	3.0		5.5 V
I_{CES}	$V_{CE} = V_{CES}$, $V_{GE} = 0V$ $T_J = 125^\circ C$			25 μA 300 μA
I_{GES}	$V_{CE} = 0V$, $V_{GE} = \pm 20V$			± 100 nA
$V_{CE(sat)}$	$I_C = 20A$, $V_{GE} = 15V$, Note 1 $T_J = 125^\circ C$		2.6 1.8	3.0 V V

TO-263 AA (IXGA)

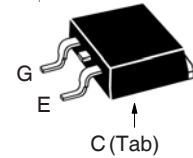

TO-220AB (IXGP)

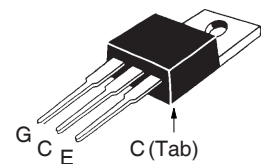

TO-247 (IXGH)

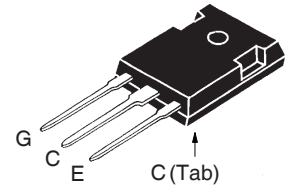

G = Gate D = Collector
S = Emitter Tab = Collector

Features

- Optimized for Low Switching Losses
- Square RBSOA
- Anti-Parallel Schottky Diode
- International Standard Packages

Advantages

- High Power Density
- Low Gate Drive Requirement

Applications

- High Frequency Power Inverters
- UPS
- Motor Drives
- SMPS
- PFC Circuits
- Battery Chargers
- Welding Machines
- Lamp Ballasts

Symbol	Test Conditions ($T_J = 25^\circ\text{C}$ Unless Otherwise Specified)	Characteristic Values		
		Min.	Typ.	Max.
g_{fs}	$I_C = 20\text{A}, V_{CE} = 10\text{V}$, Note 1	9	16	S
C_{ies}	$V_{CE} = 25\text{V}, V_{GE} = 0\text{V}, f = 1\text{MHz}$		1075	pF
C_{oes}			196	pF
C_{res}			29	pF
Q_g	$I_C = 20\text{A}, V_{GE} = 15\text{V}, V_{CE} = 0.5 \cdot V_{CES}$		38	nC
Q_{ge}			8	nC
Q_{gc}			17	nC
$t_{d(on)}$	Inductive Load, $T_J = 25^\circ\text{C}$ $I_C = 20\text{A}, V_{GE} = 15\text{V}$ $V_{CE} = 300\text{V}, R_G = 5\Omega$ Note 2		17	ns
t_{ri}			20	ns
E_{on}			0.12	mJ
$t_{d(off)}$			42	75 ns
t_{fi}			47	ns
E_{off}			0.09	0.18 mJ
$t_{d(on)}$	Inductive Load, $T_J = 125^\circ\text{C}$ $I_C = 20\text{A}, V_{GE} = 15\text{V}$ $V_{CE} = 300\text{V}, R_G = 5\Omega$ Note 2		16	ns
t_{ri}			21	ns
E_{on}			0.16	mJ
$t_{d(off)}$			70	ns
t_{fi}			90	ns
E_{off}			0.33	mJ
R_{thJC}			0.56	$^\circ\text{C/W}$
R_{thCS}	TO-220	0.50		$^\circ\text{C/W}$
	TO-247	0.21		$^\circ\text{C/W}$

Reverse Diode (SiC)

Symbol	Test Conditions ($T_J = 25^\circ\text{C}$ Unless Otherwise Specified)	Characteristic Values		
		Min.	Typ.	Max.
V_F	$I_F = 10\text{A}, V_{GE} = 0\text{V}$, Note 1 $T_J = 125^\circ\text{C}$		1.65 1.80	V V
R_{thJC}				1.10 $^\circ\text{C/W}$

Notes

1. Pulse test, $t \leq 300\mu\text{s}$, duty cycle, $d \leq 2\%$.
2. Switching times & energy losses may increase for higher $V_{CE}(\text{Clamp})$, T_J or R_G .

IXYS Reserves the Right to Change Limits, Test Conditions and Dimensions.

TO-263 (IXGA) Outline

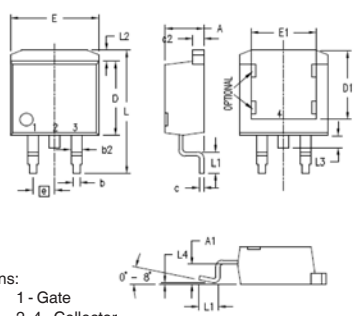

Pins:
1 - Gate
2, 4 - Collector
3 - Emitter

SYM	INCHES		MILLIMETERS	
	MIN	MAX	MIN	MAX
A	.160	.190	4.06	4.83
A1	.080	.110	2.03	2.79
b	.020	.039	0.51	0.99
b2	.045	.055	1.14	1.40
c	.016	.029	0.40	0.74
c2	.045	.055	1.14	1.40
D	.340	.380	8.64	9.65
D1	.315	.350	8.00	8.89
E	.380	.410	9.65	10.41
E1	.245	.320	6.22	8.13
e	.100 BSC		2.54 BSC	
L	.575	.625	14.61	15.88
L1	.090	.110	2.29	2.79
L2	.040	.055	1.02	1.40
L3	.050	.070	1.27	1.78
L4	0	.005	0	0.13

TO-220 (IXGP) Outline

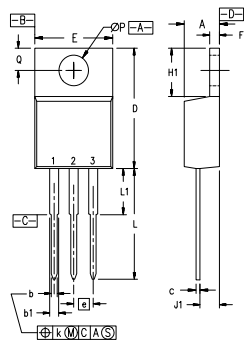

Pins: 1 - Gate
2, 4 - Collector
3 - Emitter

SYM	INCHES		MILLIMETERS	
	MIN	MAX	MIN	MAX
A	.170	.190	4.32	4.83
b	.025	.040	0.64	1.02
b1	.045	.065	1.15	1.65
c	.014	.022	0.35	0.56
D	.580	.630	14.73	16.00
E	.390	.420	9.91	10.66
e	.100 BSC		2.54 BSC	
F	.045	.055	1.14	1.40
H1	.230	.270	5.85	6.85
J1	.090	.110	2.29	2.79
k	0	.015	0	0.38
L	.500	.550	12.70	13.97
L1	.110	.230	2.79	5.84
ØP	.139	.161	3.53	4.08
Q	.100	.125	2.54	3.18

TO-247 Outline

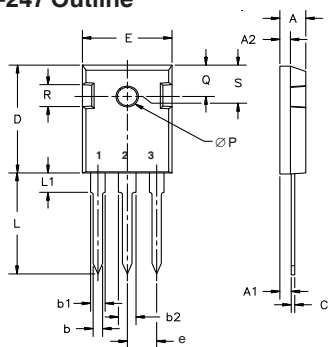

Pins: 1 - Gate
2 - Collector
3 - Emitter

Dim.	Millimeter		Inches	
	Min.	Max.	Min.	Max.
A	4.7	5.3	.185	.209
A ₁	2.2	2.54	.087	.102
A ₂	2.2	2.6	.059	.098
b	1.0	1.4	.040	.055
b ₁	1.65	2.13	.065	.084
b ₂	2.87	3.12	.113	.123
C	.4	.8	.016	.031
D	20.80	21.46	.819	.845
E	15.75	16.26	.610	.640
e	5.20	5.72	0.205	0.225
L	19.81	20.32	.780	.800
L1		4.50		.177
ØP	3.55	3.65	.140	.144
Q	5.89	6.40	0.232	0.252
R	4.32	5.49	.170	.216

Fig. 1. Output Characteristics @ $T_J = 25^\circ\text{C}$

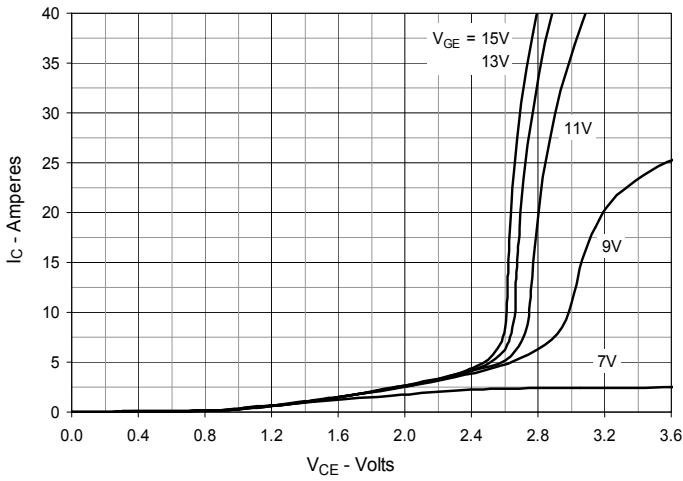

Fig. 2. Extended Output Characteristics @ $T_J = 25^\circ\text{C}$

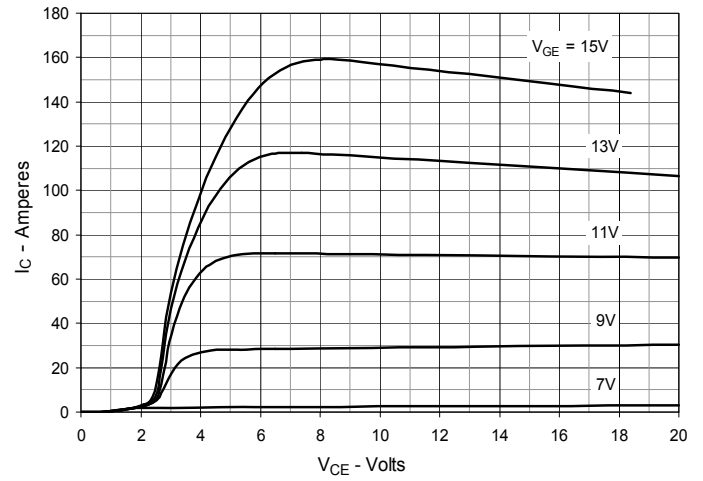

Fig. 3. Output Characteristics @ $T_J = 125^\circ\text{C}$

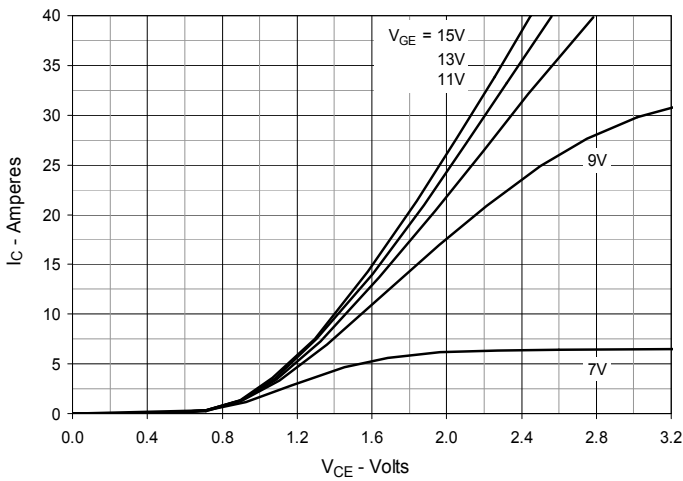

Fig. 4. Dependence of $V_{CE(sat)}$ on Junction Temperature

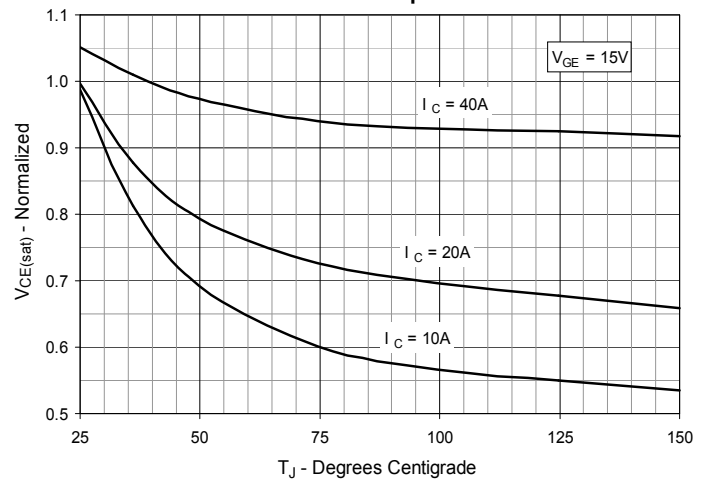

Fig. 5. Collector-to-Emitter Voltage vs. Gate-to-Emitter Voltage

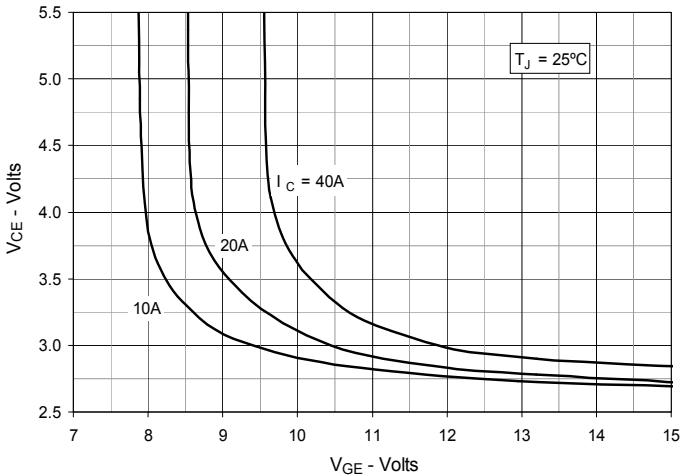

Fig. 6. Input Admittance

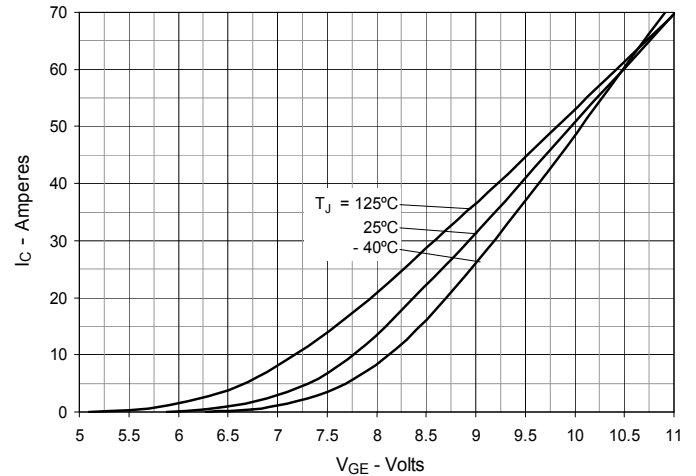

Fig. 7. Transconductance

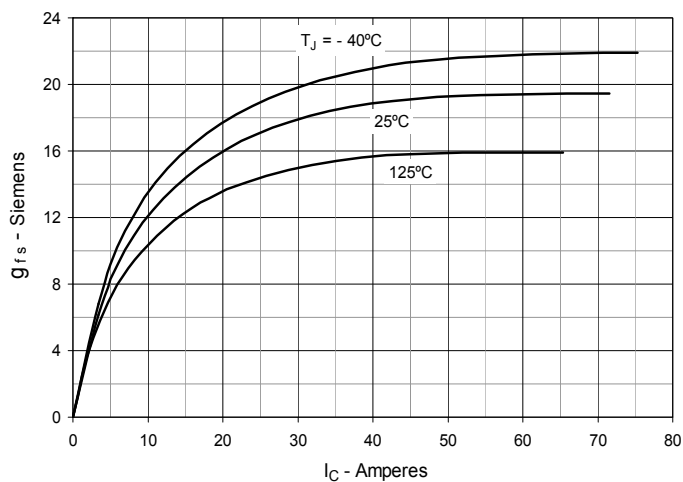

Fig. 8. Gate Charge

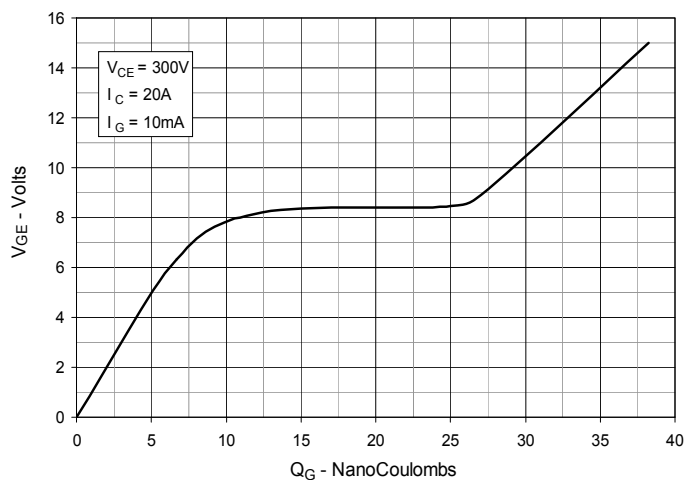

Fig. 9. Capacitance

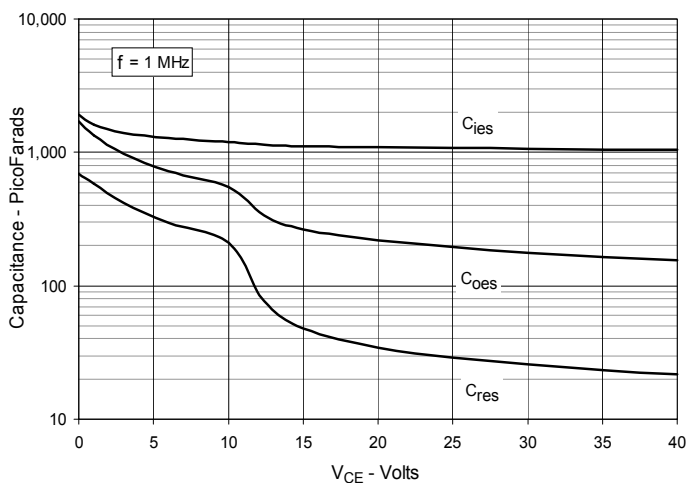

Fig. 10. Reverse-Bias Safe Operating Area

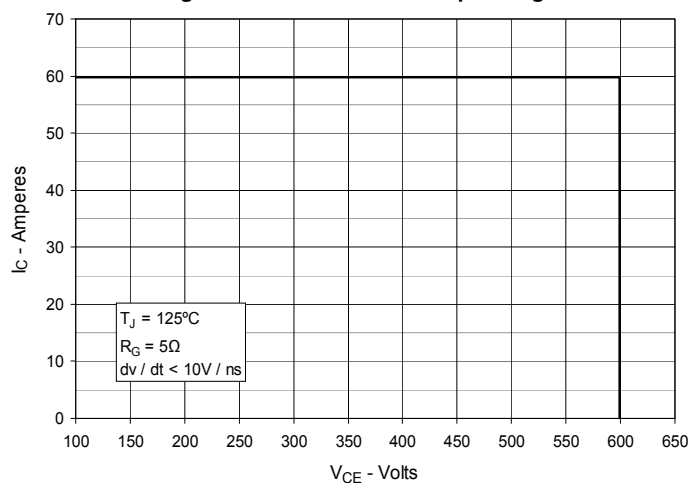

Fig. 11. Maximum Transient Thermal Impedance for IGBT

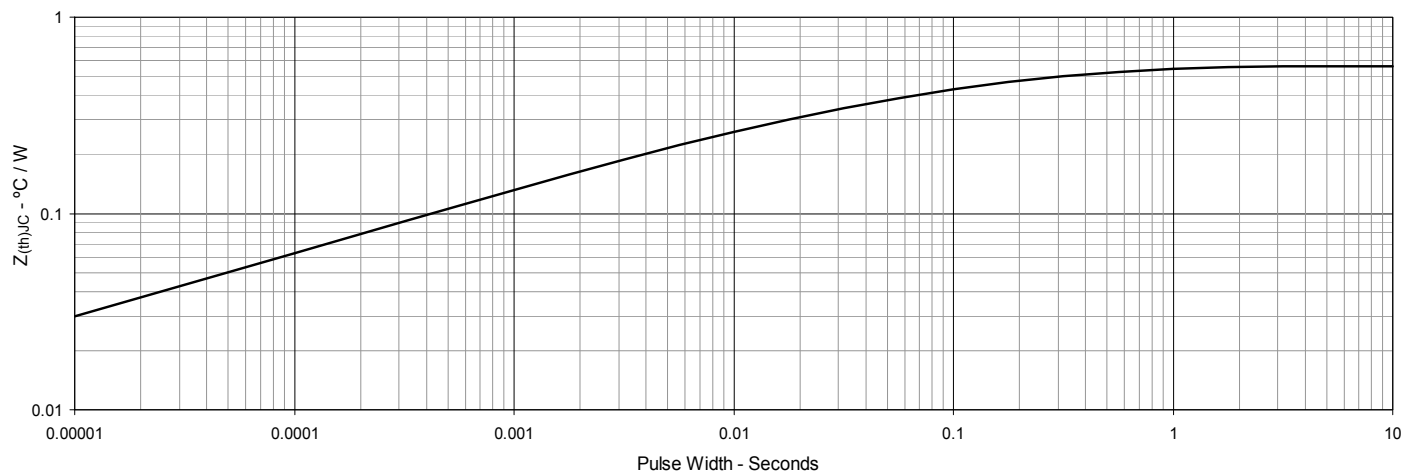

Fig. 12. Inductive Switching Energy Loss vs. Gate Resistance

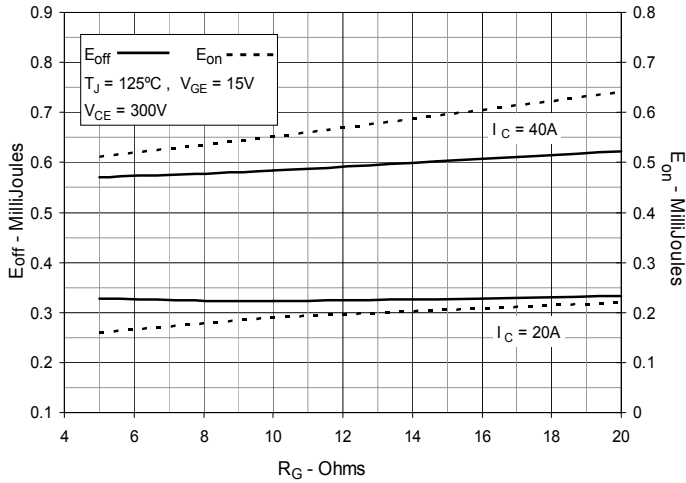

Fig. 13. Inductive Switching Energy Loss vs. Collector Current

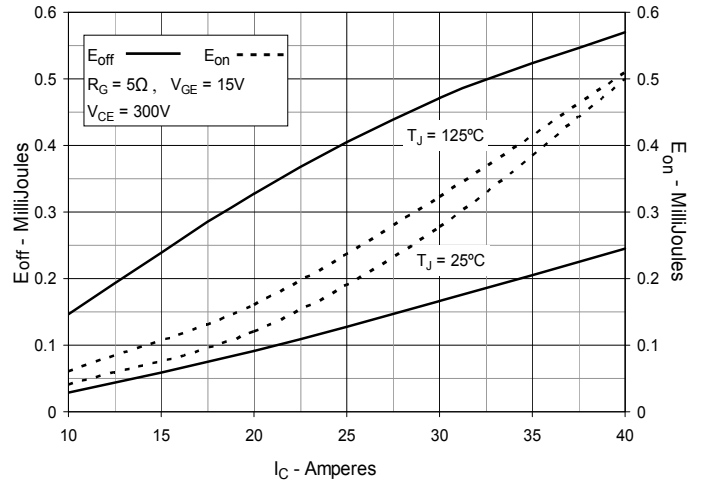

Fig. 14. Inductive Switching Energy Loss vs. Junction Temperature

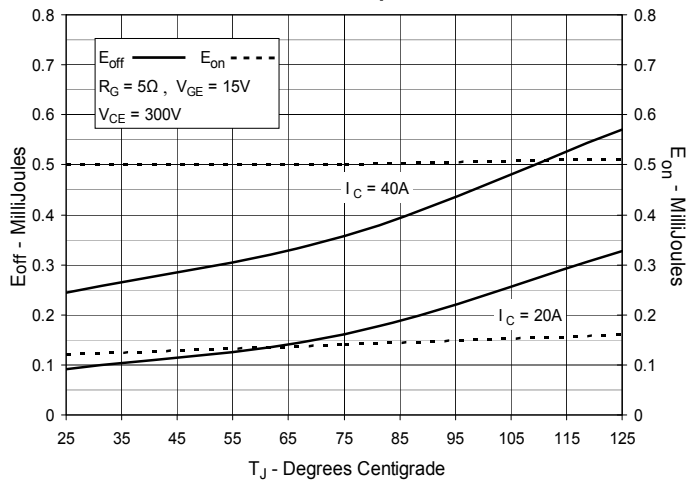

Fig. 15. Inductive Turn-off Switching Times vs. Gate Resistance

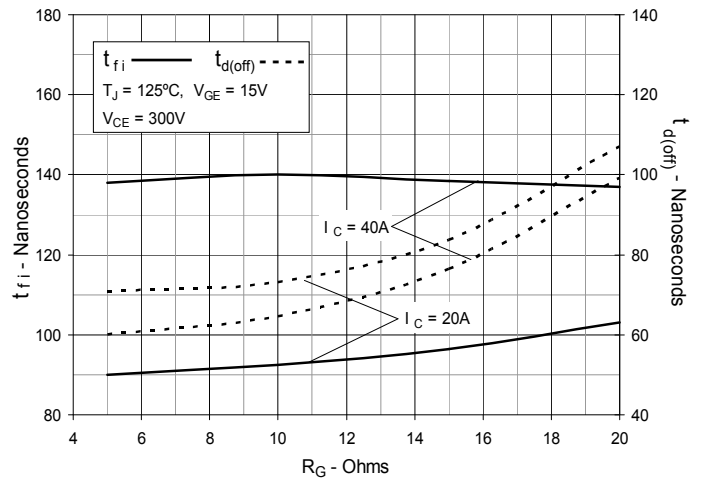

Fig. 16. Inductive Turn-off Switching Times vs. Collector Current

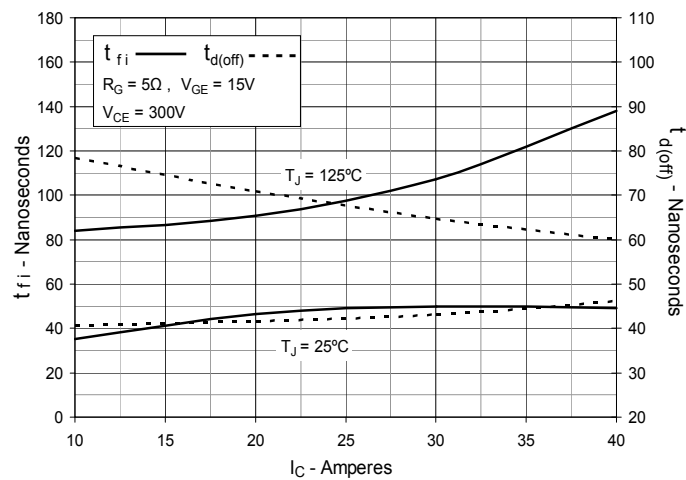

Fig. 17. Inductive Turn-off Switching Times vs. Junction Temperature

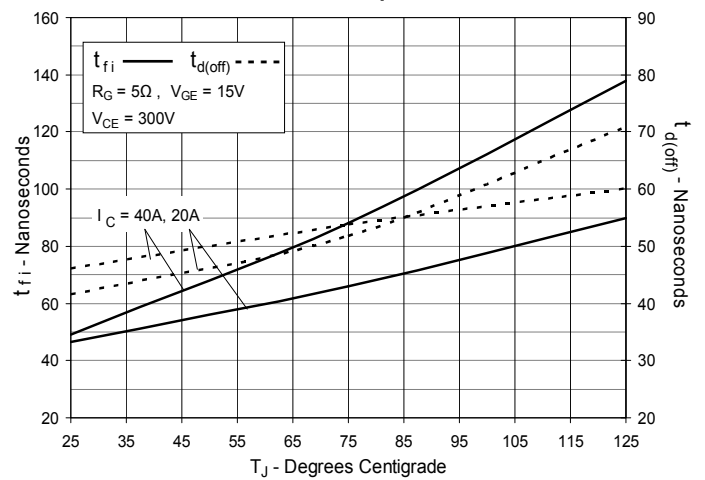

Fig. 18. Inductive Turn-on Switching Times vs. Gate Resistance

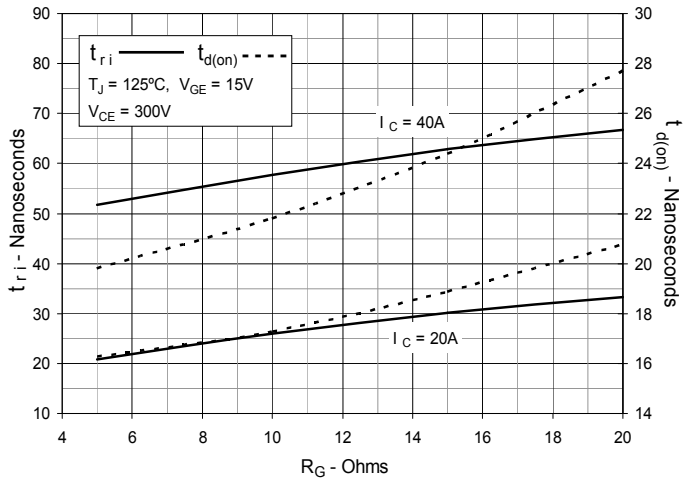

Fig. 19. Inductive Turn-on Switching Times vs. Collector Current

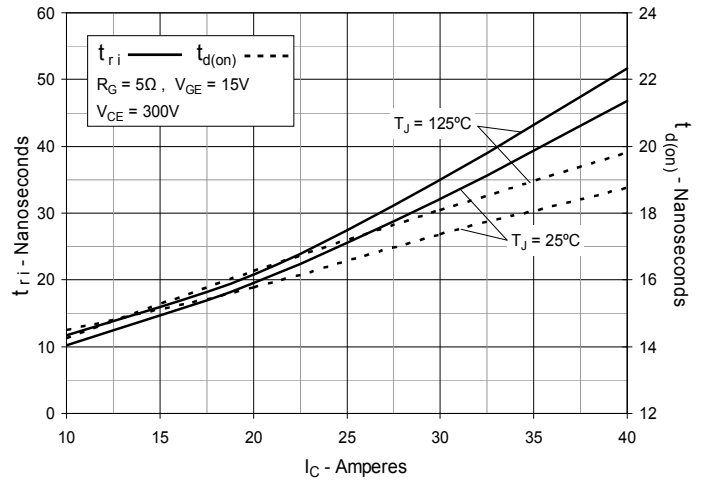

Fig. 20. Inductive Turn-on Switching Times vs. Junction Temperature

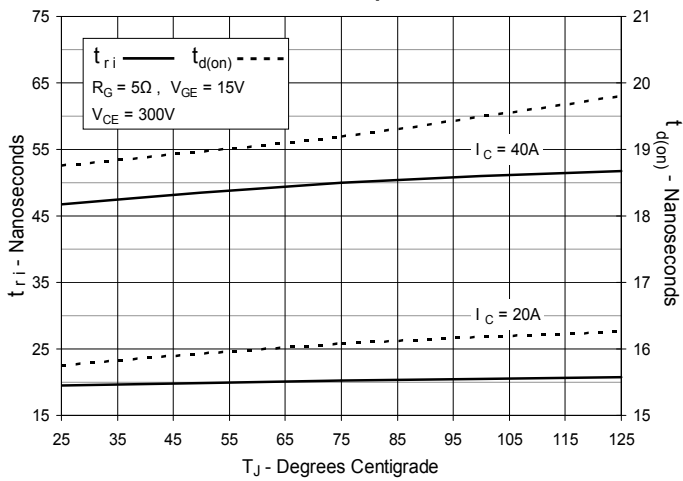

Fig. 21. Forward Current vs. Forward Voltage

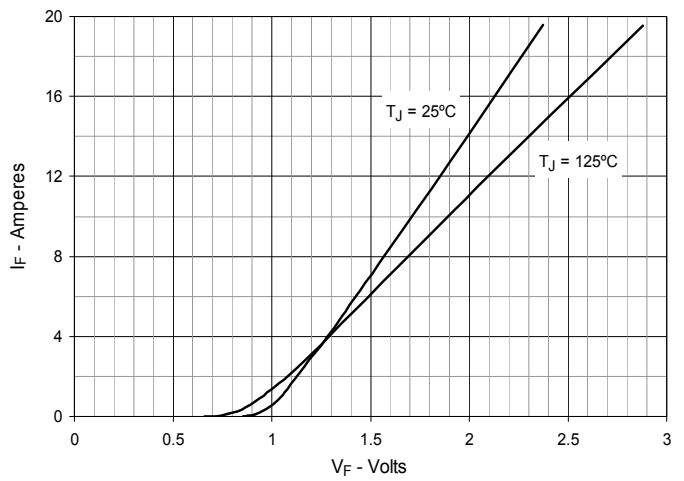

Fig. 22. Maximum Transient Thermal Impedance for Diode

