

for sheared contacts

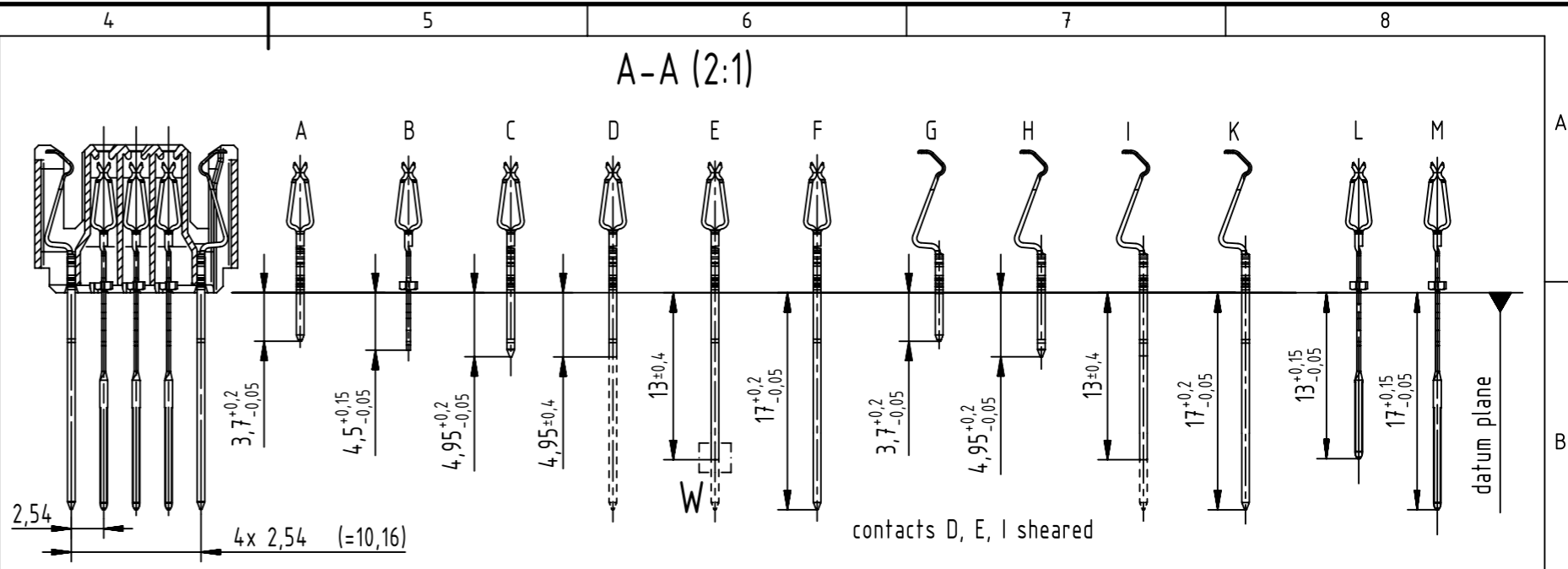

B (2:1)

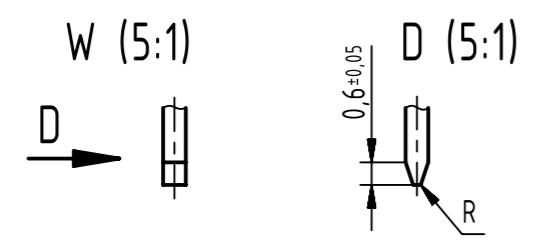

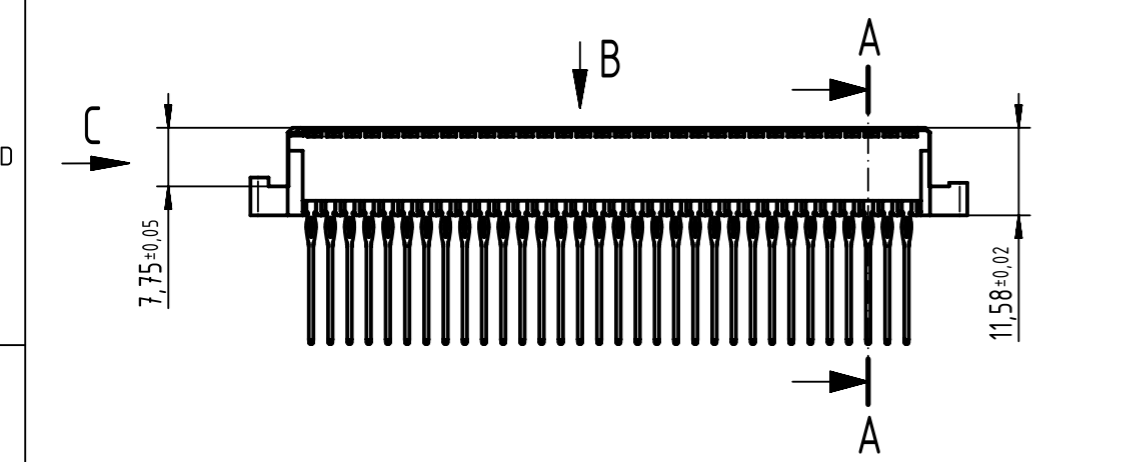
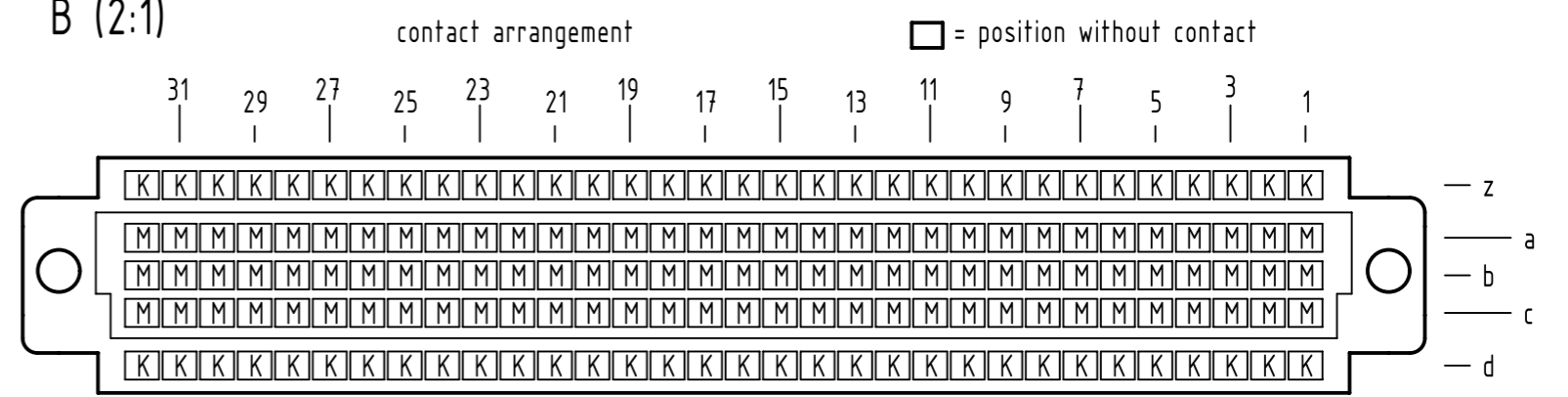

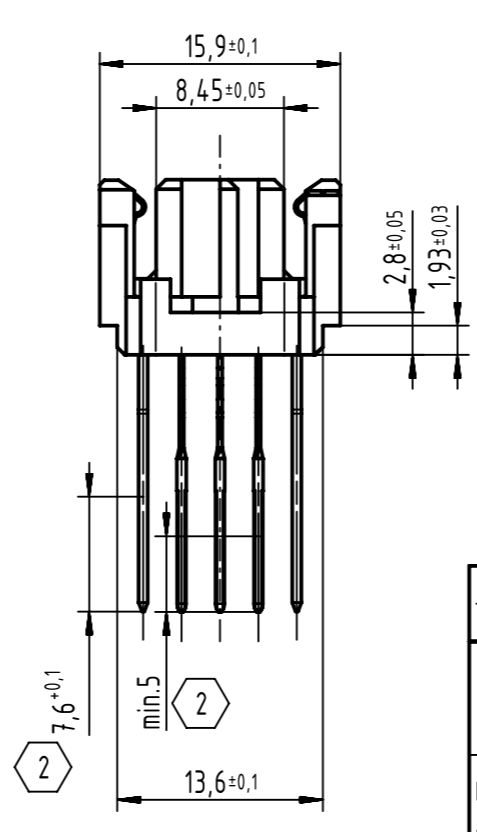
C (2:1)

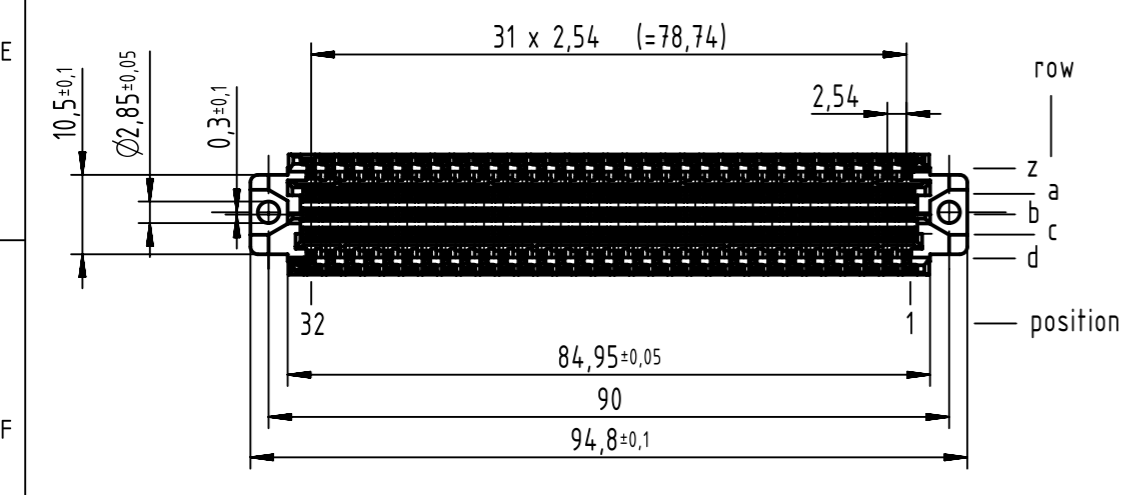
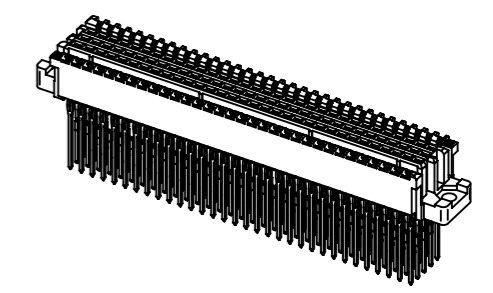

- $\text{⊕} 2$ mating zone equal performance level
- $\text{⊕} 1$ recommended configuration of plated through holes and further information see: DS 02022100101



 All Dimensions in mm Original Size DIN A3				Scale 1:1	Free size tol. IEC 61076-4-113	Ref. Sub. TB 0202160X301 500000068399 2013-11-11
 All rights reserved Department EC PD - DE				Created by ZWAHR	Inspected by ELLERMANN	Standardisation HOFFMANN
HARTING Electronics GmbH D-32339 Espelkamp				Title har-bus 64 female press-in with flange 160-pole		
Type TB			Number 0202160X301			
				Doc-Key / ECM-Nr. 100070213/UGD/017/D 500000081681	Rev. D	Page 1/1

02 02 160 2301	2
02 02 160 1301	1
part no.	performance level $\text{⊕} 1$