

# Section 1

## Introduction

### 1-1 Introducing the 5 1/2 Digit Dual Display Bench Multimeters

***NOTE***

1. This operation manual contains information and warning that must be followed to ensure user operation safety and to retain the meter safety condition.
2. The term “5492” and “5491” will be used to refer to respective models when descriptions for either model is applied.
3. The term “the meter” will be used to refer to both “5492” and “5491” when descriptions are applied to both models.

 **Precaution!**

**TO ENSURE PERSONAL SAFETY AND TO AVOID DAMAGING THE METER AND THE EQUIPMENT CONNECTED, READ “GETTING STARTED” IN SECTION 2-2 BEFORE USING THE METERS.**

The Dual Display Multimeter 5492 & 5491 (also referred to as “the meter” in this manual) are 5 1/2 digit multimeters with 120,000 count high resolution. Both meters are designed for bench-top, field service, and system applications with a high performance/price ratio. Complete specifications are provided in Appendix A for 5492 and B for 5491 respectively.

With the RS-232 computer interface (standard), the meter is fully programmable for use on the RS-232 interface.

With the IEEE-488 computer interface (optional) installed, the 5492 is fully programmable for use on IEEE-488.1 interface bus (1987). The meter is also designed in compliance with supplemental standard IEEE-488.2 (1987).

## 1-2 Features

The main features provided by the meter are:

- A dual, Vacuum Fluorescent Display (VFD) that allows two properties of input signal to be displayed at the same time. (e.g., DC voltage on one display and AC voltage on the other).
- Remote operation via RS-232 interface (standard) or IEEE-488 interface (optional).
- 120,000, 40,000, and 4,000 counts for different measuring rate:  
Slow Rate (120,000 counts) – 2 readings/sec;  
Medium Rate (40,000 counts) – 5 readings/sec;  
Fast Rate (4,000 counts) – 20 readings/sec.
- 1 $\mu$ V sensitivity in Vdc measurement.
- True RMS Vac with 20Hz to 100kHz bandwidth for 5492, and 40Hz to 30kHz for 5491.
- (Vac+Vdc) RMS and (Aac+Adc) RMS, calculated.
- Selectable 2-wire and 4-wire resistance measurements.
- Resistance measurements up to 120M $\Omega$  with 1m $\Omega$  resolution at slow reading rate or up to 300M $\Omega$  with 10m $\Omega$  and 100m $\Omega$  resolution at medium and fast reading rate respectively.
- Wide dc and ac current measurement ranges: 12mA ~ 12A.
- Frequency measurements greater than 1MHz with 0.01Hz best resolution.
- dBm measurement with variable reference impedance from 2 $\Omega$  to 8000 $\Omega$  and audio power measurement capability.
- Zeroing mode (REL) to offset residual reading before taking a measurement.
- Compare mode to determine if a measurement is within, above, or below a designated range (Hi/Lo/Pass).
- Dynamic recording mode to keep minimum and/or maximum readings of measurements.
- CAL mode to provide electronic closed-case calibration (no internal adjustments).

## 1-3 Options and Accessories

At the moment, one option is available for 5492 only, which option can be installed at the factory and a field installable retrofit kit option is also available:

- IEEE-488 interface (Option GP5492) provides full programmability. There are two types of programming commands: IEEE 488.2 Common Commands and Standard Commands for Programmable Instruments (SCPI). The SCPI commands used in this device is conformance with the SCPI Standard Version 1993.0.

### **Standard accessories come with the meter are:**

- Power cord
- Protective holsters (Front and Rear)
- Operation Manual
- TL 36\* Test leads
- AC 01 Cap for TL 36

**\* Maximum Measurement Ratings: 1kVdc, 10A dc or ac rms continuous, and 12A dc or ac rms for 30 seconds maximum.**

### **Available optional accessories are listed as below:**

- TL 35\* Test leads
- TH 02 Insulation piercing clip
- AC 02 Lantern tip extension probe for TL 35
- AC 03 Alligator clip
- KC 01 4wire test cable set with Kelvin clippers
- AK 5491 RS-232 PC Link software
- GP5492 IEEE-488 GPIB Interface Upgrade (Only for 5492)
- RK 01 Rack-mount kit (used for single meter)

**\* Maximum Measurement Ratings: 1kVdc, 10A dc or ac rms continuous, and 12A dc or ac rms for 30 seconds maximum.**

## **1-4 How to use this manual**

This manual is designed to help the user to get a quick start. Though it is not necessary to read the entire manual to operate the unit effectively, we recommend the manual to be read thoroughly in order to use the meter to its full advantages.

First scan the Tables of contents to be familiar with the outline of the manual. Then read “Getting Started” in Section 2-2. Refer to the appropriate section of the manual as needed. The contents of each section are summarized below.

### **Section 1. Introduction**

Introducing the general information of features, options, accessories, and operation manual for the 5 1/2 digit Dual Display Multimeters.

### **Section 2. Getting Started**

Introducing how to prepare the meter for operation and to start taking basic front panel operations and measurements quickly.

### **Section 3. Operating the Meter from the Front Panel**

Providing a complete description of each operation, which can be performed by using the pushbuttons on the front panel. All related information for operations and functions are grouped together.

### **Section 4. Measurement Application Examples**

Describing how to use the meter in more advanced and sophisticated operations and applications.

### **Section 5. Calibrating the Meter**

Describing the basic information to calibrate the meter if necessary.

### **Section 6. RS-232 Remote Operation**

Describing how to connect the meter to a terminal or a host computer and operate the meter via RS-232 interface.

### **Section 7. GPIB Remote Operation (5492 Option)**

Describing how to connect the meter to a terminal or a host computer and operate the meter via GPIB interface.

### **Appendices**

**Appendix A: 5492 Specifications**

**Appendix B: 5491 Specifications**

**Appendix C: Maintenance**

## Getting Started

### 2-1 Introduction

Section 2 describes the front panel operational keys, displays, input terminals and rear panel of the meter, adjusting handle, explains general operating features.

### 2-2 Getting Started

- **Unpacking and Inspecting the Meter**

Carefully remove the meter from its shipping container and inspect it for possible damage or missing items. If the meter is damaged or something is missing, contact the place of purchase immediately. Save the container and packing material in case user has to return the meter.

- **Front Panel**

The front panel (shown in Figure 2-1) has three main elements: the input terminals on the left, the primary/secondary displays, and the pushbuttons. The pushbuttons are used to select major functions, ranging operations, and function modifiers. These elements are described in detail in Section 3.

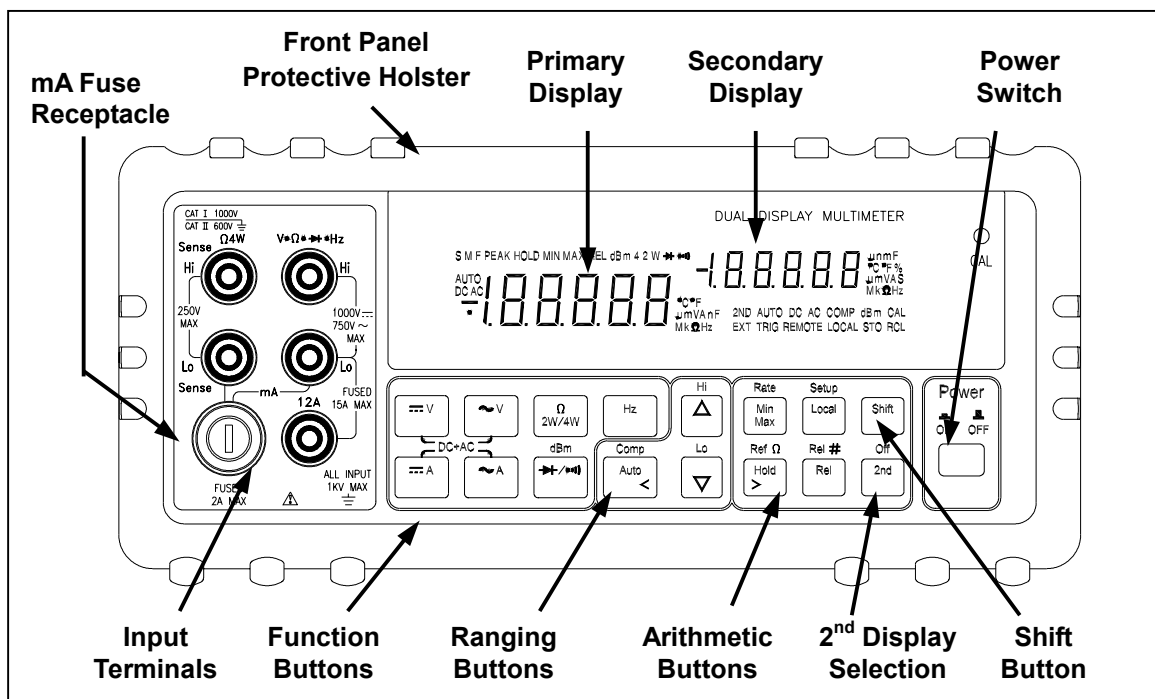

Figure 2-1. Front Panel

- **Rear Panel**

The rear panel (shown in Figure 2-2) contains a line fuse, the power-line cord connector, an RS-232 interface connector, and a cutout for IEEE-488 interface (optional) connector.

- **Line Power**

- Figure 2-2 illustrates the location of the Line Voltage Selector with Fuse Holder housing. If user has already done so, plug the line cord into the connector on the rear of the meter. The meter will operate at any line voltage between 90Vac and 264Vac when “line voltage selector” is set properly, and its frequency range is at 50/60Hz. For operation safety, DO NOT APPLY a line voltage that exceeds the range specified to line cord connector on the rear panel of the meter.

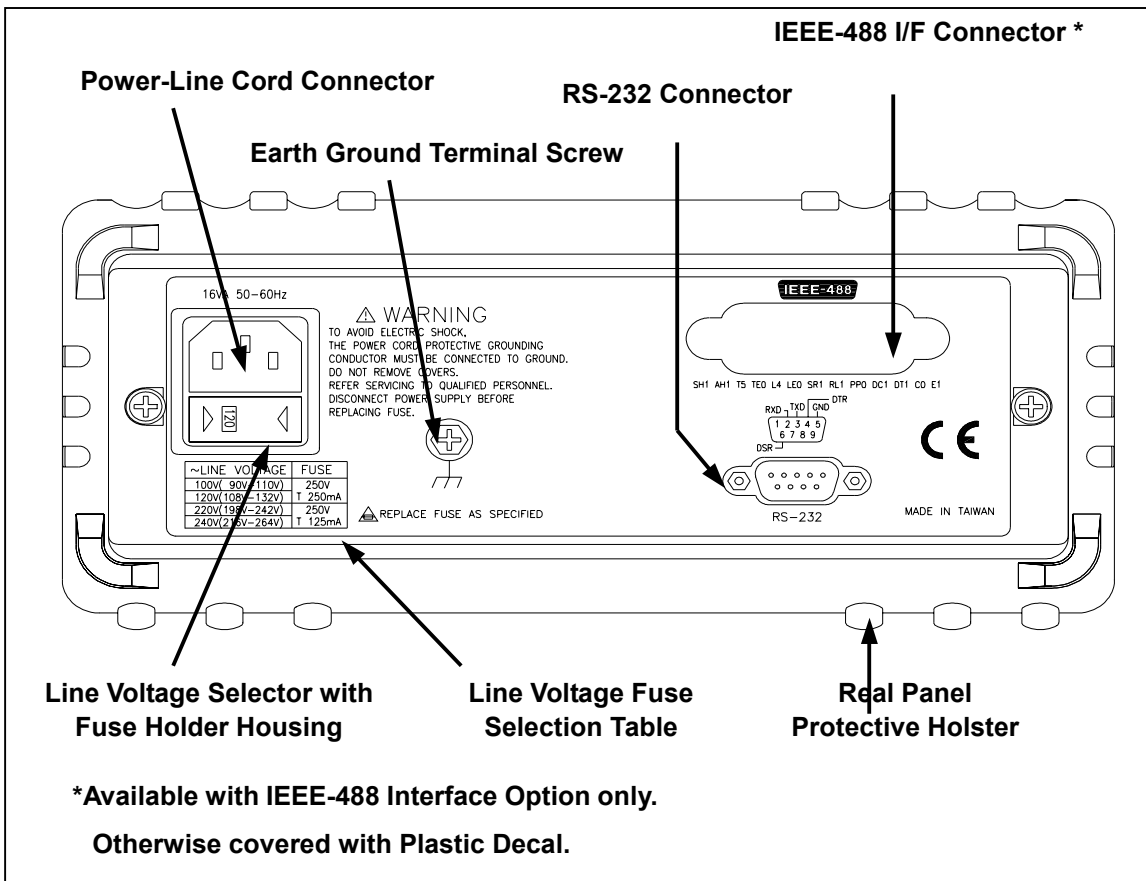

**Figure 2-2. Rear Panel**

**⚠ CAUTION!**

**BEFORE TURNING THE METER ON, MAKE SURE THE LINE VOLTAGE SELECTOR IS SET TO THE CORRECT POSITION FOR APPLIED LINE VOLTAGE TO THE POWER-LINE CORD CONNECTOR.**

- The “line voltage selector” is settable for 100Vac, 120Vac, 220Vac, and 240Vac line voltages.
- The correct fuse ratings: 250mA fuse for 100Vac or 120Vac is selected, and 125mA fuse for 220Vac or 240Vac is selected.

- **Case, Panels and Holsters**

To avoid electric shock or injury, do not operate the meter without panels or case in place.

The meter is provided with special designed anti-slippery protective holsters on the front and rear panel sides (shown in Figure 2-1 and 2-2).

The holsters provide a protection to both front and rear panels of the meter as well as its corners. User may stack up one meter on the top of the other without concerning the slide off of the units (shown in Picture 2-1).

The holsters can be easily removed when install the rack-mounted ears to the meter in order to mount the meter into a 19-inch standard rack. Refer to Section 2-7 for Rack Mounting procedures.



**Picture 2-1. Stack up the Meters with Holsters**

- **Grounding the Meter**

The meter is grounded through power cord. To avoid electric shock or injury, grounding wire in the power line cord must be connected.

- **Operating in Explosive Atmospheres**

The meter does not provide explosion protection for explosive gasses or arcing components. Do not operate the meter in such circumstances.

- **Adjusting Handle**

For bench-top use, the handle can be adjusted to provide three viewing angles. For viewing positions, pull the ends out to a hard stop (about 1/4 inch on each side) and rotate it to one of four stop positions (shown in Figure 2-3) To remove the handle, adjust it to the vertical stop position and pull the ends all the way out.

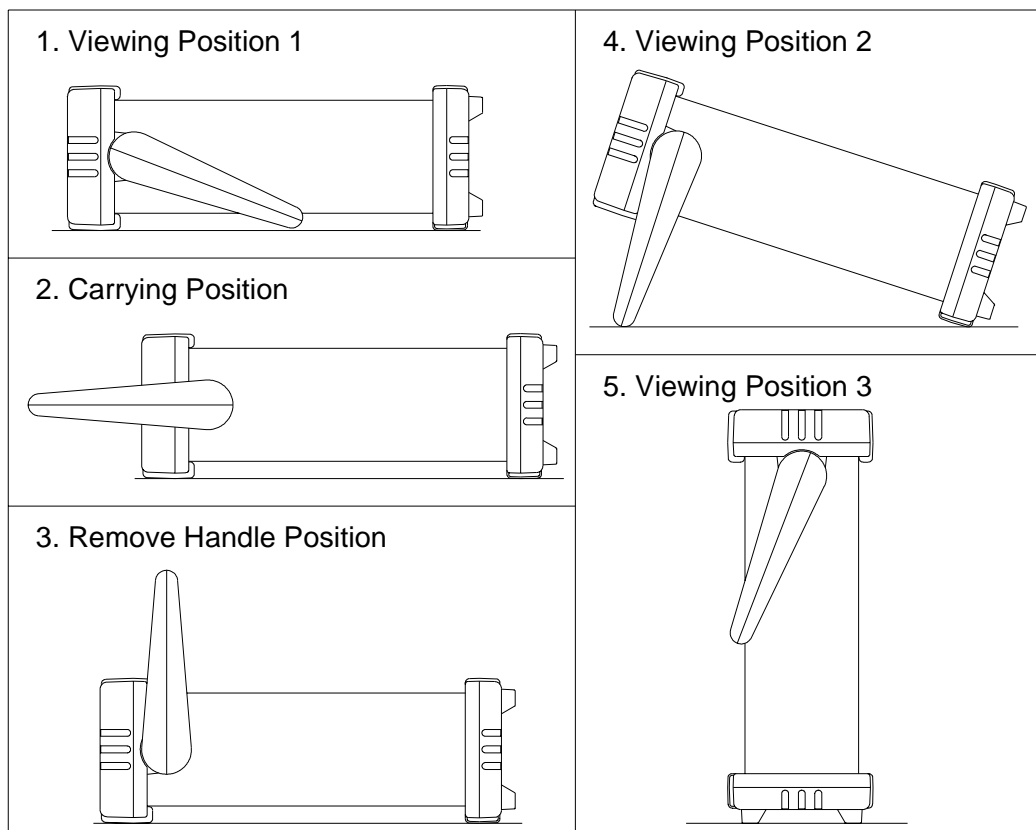

**Figure 2-3. Adjusting Handle**



## 2-3 Turning the Meter ON

To turn the meter on, press the **Power** button to “IN” position located on the lower right of the front panel. When the meter is turned on, the primary and secondary displays light for about 2 seconds while an internal self-test running by its digital circuitry. If the **Hold** button is pressed while the power-up sequence is in progress, all segments and annunciators of the entire display remain on until another button is pressed. Then the power-up sequence continues.

After the meter completing its power-up sequence, it resumes the power-up measurement configuration stored in non-volatile memory. The power-up default configuration status set at factory is shown in Table 3-2.

## 2-4 Selecting Current Input Terminals and Measurement Range

If current (dc or ac) is being measured in the Auto-ranging mode, with a signal input on the 1200mA terminal (5492) or 120mA terminal (5491), the meter will select the range automatically.

If a signal input is applied to the 12A input terminal, the meter will not select the range to 12A automatically. User will need to select the current measurement range to 12A manually.

## 2-5 Using the Pushbuttons

The meter functions and operations can be selected by pressing the pushbuttons on the front panel select.

A summary of pushbuttons is shown in Figure 2-4.

Pushbuttons can be used in three ways. User can:



- Press a single button to select a function or operation.



EXAMPLE:

 (Press)  to select AC volts for the primary display.

- Press a combination of buttons, one after the other.

EXAMPLE:

  to select AC volts for the primary display, and then

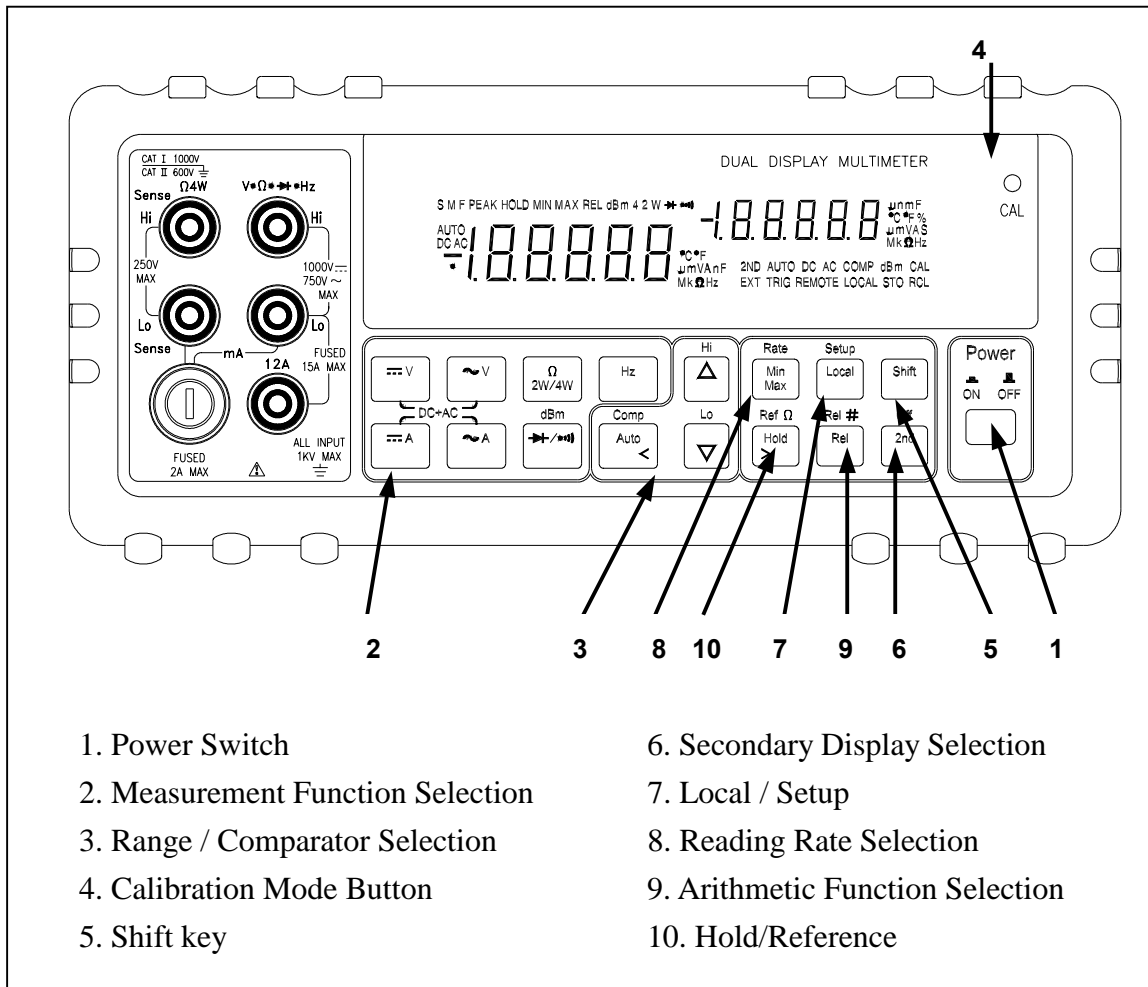

  to select the frequency measurement.



**Figure 2-4. Front Panel Pushbuttons**

- Press multiple buttons simultaneously.

EXAMPLE:

  and  simultaneously to select True RMS AC volts and DC volts (calculated) on the primary display.

**More detail operations are described in Section 3.**

## 2-6 Basic Measurement Examples

This section describes the basic measurement procedures via operations in front panel. These procedures as follows provide the user who wants to get a quick start, but does not want to read the entire manual thoroughly. But it is still recommended to read this manual thoroughly in order to fully utilize all advantages in the meter.

- **Voltage, Resistance or Frequency Measurements**

Press the desired function button and connect the test leads (TL 36 or TL 35 as described in Section 1-3) as shown in Figure 2-5 to measure voltage, resistance, or frequency. The meter will select the appropriate range in the auto-range mode, and an annunciator on the display will indicate measurement units.

***NOTE***

*Excessive error may occur when making measurements with 1 to 10  $\mu$ V resolutions after measuring high voltage up to 1000 volts dc. It requires two minutes before making low-level measurements.*

- **Current Measurements**

To measure current, connect the test leads to mA input terminal or 12A input terminal for measured current above 1200mA (5492) / 120mA (5491) as shown in Figure 2-6.

Be sure to turn off the power in the circuit to be measured before taking current measurement.

Break the circuit on the groundside to minimize the common mode voltage) to be measured, and place the meter in series at that point.

Turn on power to the circuit, and then read the display. The meter will select the appropriate range automatically, and an annunciator on the display will indicate the units of the measurement value shown.

Turn off power to the circuit and disconnect the meter from the tested circuit.

***NOTE***

*After making a high current measurement using the 12A input, thermal voltages are generated that may create errors when making high-resolution low-level dc measurements of volts, amps, or ohms.  
It requires ten minutes to allow the thermals to settle out before making low-level measurements in order to obtain the best accuracy.*

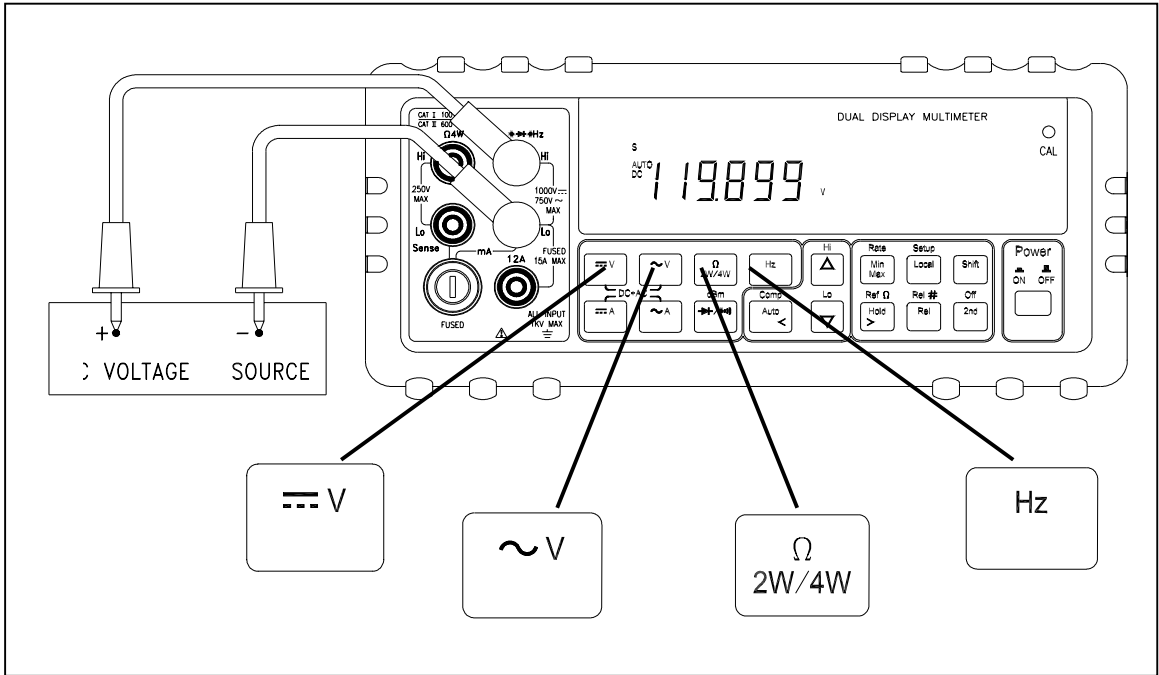

**Figure 2-5. Voltage, Resistance or Frequency Measurements**

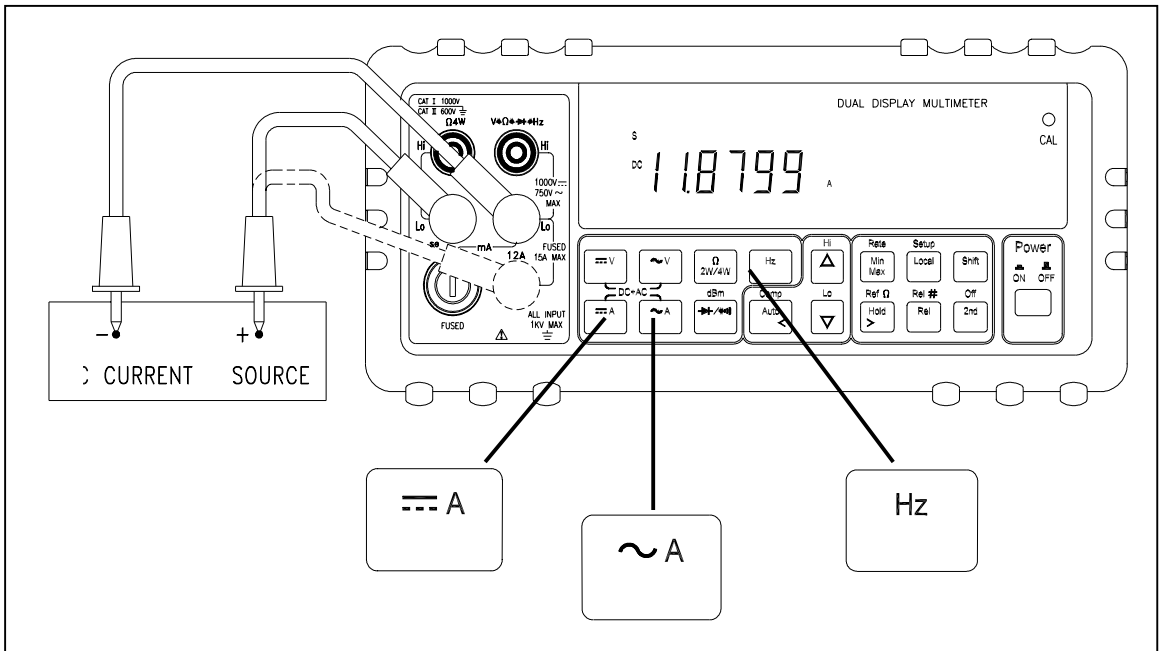

**Figure 2-6. Current or Frequency Measurements**

- **Diode and Continuity Tests**

Each press of  toggles the diode and continuity functions. Both functions cannot be selected for the secondary display.

The diode test measures the forward voltage of a semiconductor junction at approximately 0.5mA. The beeper generates a single beep tone when the input voltage drops below +0.7V (approximately 1.4k $\Omega$ ) and generates a continuous beep tone when the input voltage drops below +50mV (approximately 100 $\Omega$ ).

Readings are displayed in the 1.2V range at the slow measurement rate, and 4V range at the medium and fast measurement rates. “OL” is displayed for voltage above 1.2V at the slow measurement rate and 2.5V at the medium and fast measurement rates. If the diode/continuity test is performed at the slow reading rate, readings are displayed in 10 $\mu$ V resolution on the 1.19999V (1.2V) range.

The continuity test measures the resistance of a tested circuit with 2-wire method at approximately 0.5mA and determines whether a circuit is intact. The beeper generates a continuous beep tone when the input resistance value is less than approximately 10 $\Omega$ .

For continuity test, the measurement range will be fixed at 120 $\Omega$  range if the slow reading rate is selected. The measurement range will be fixed at 400 $\Omega$  range if the medium or fast reading rate is selected.

Press  to select diode test function, then connect the test leads across the diode under test as shown in Figure 2-7 (Reversing the polarity will reverse-bias the diode).

Press  again to select continuity test function, then connect the test leads or across the tested circuit as shown in Figure 2-8.

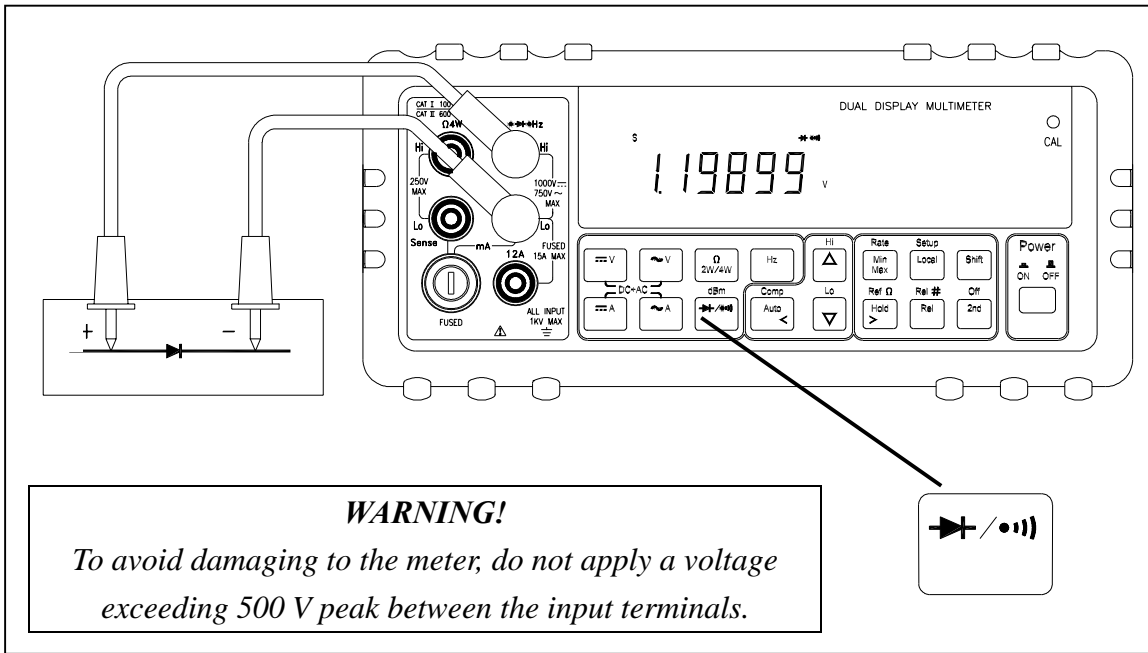

**Figure 2-7. Diode/Continuity Test**

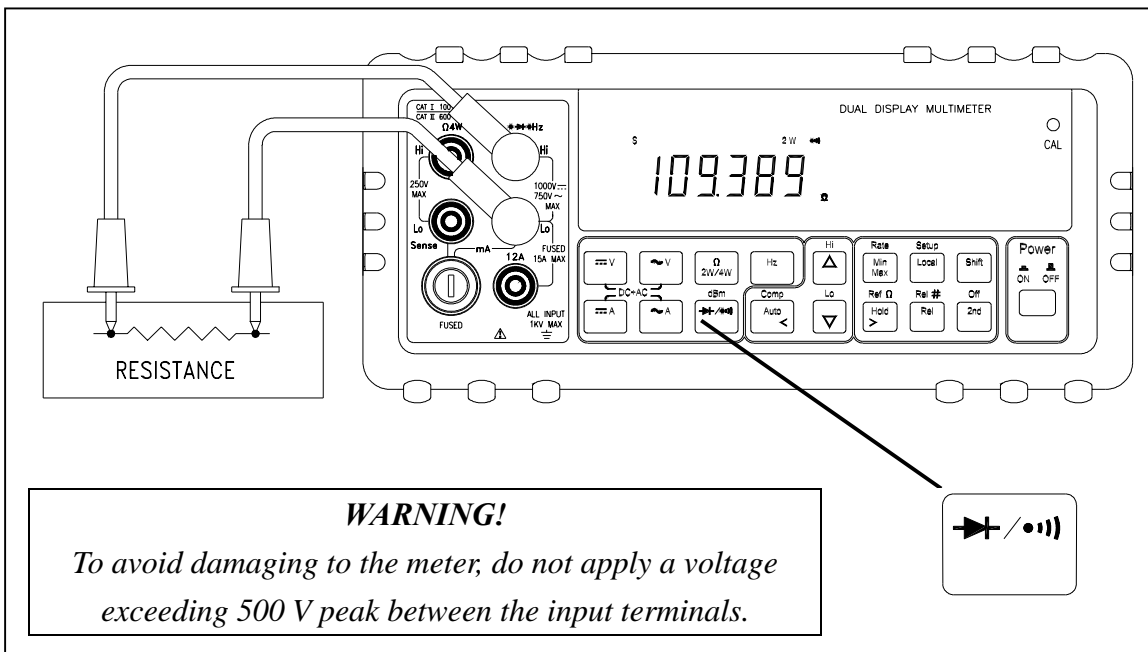

**Figure 2-8. 2-Wire  $\Omega$ /Continuity Test**

## 2-7 Rack Mounting

User can mount the meter into a standard 19-inch rack using RK 01 (for single meter) Rack Mount Kit. The front and rear protective holsters can be removed when mount the meter into a rack.

To install RK 01 rack mount kit, refer to following procedures and Figure 2-9 or the instructions provided with it:

1. Adjusting the handle of the meter to its upward vertical stop position (refer to Figure 2-3) and pull the ends all the way out.
2. Removing two protective holsters out of the front panel and rear panel of the meter.
3. Installing the rack mount ears onto the left and right hand side of the meter frame by using four screws provided with RK 01.
4. Paste two blind plates on the handle hole.
5. Mount the meter with RK 01 into the standard 19" rack.

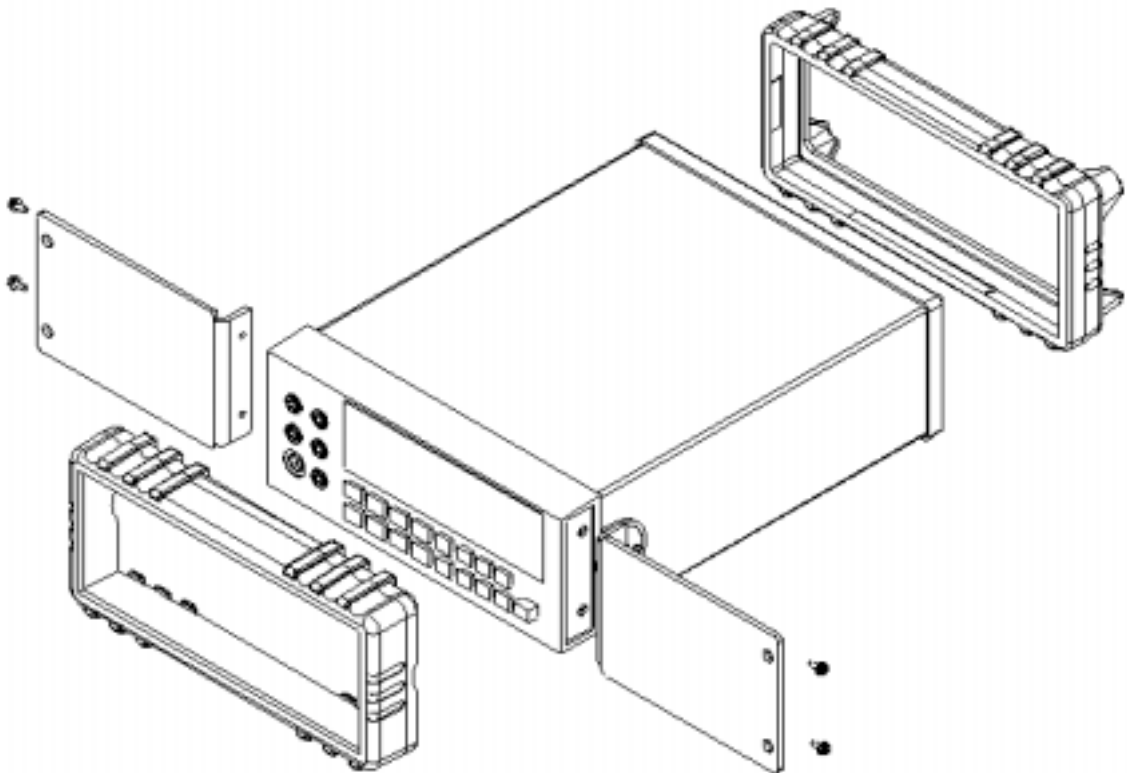

**Figure 2-9. Installing the Rack Mount Kit**

(This page is subject to be blank)



# Front Panel Operation

### 3-1 Introduction

This section provides a complete description of each operation that can be performed by using the pushbuttons on the front panel.

All related information for operations and functions are grouped together.

### 3-2 Front Panel Operations

The following operations can be performed from the front panel:

- Select a measurement function (Vdc, Vac, Adc, Aac, resistance, frequency, and diode/continuity test) for the primary and secondary display.
- Take a measurement and display a reading.
- Select the manual or auto-range mode (AUTO)
- Manually select a measurement range for the primary display.
- Select function modifier that cause the meter to display relative readings (REL), minimum or maximum values (MIN MAX) or decibels (dBm and dB), or to enter the Data Hold mode (HOLD) to hold a reading on the primary display.
- Change the measurement rate (SLOW, MEDIUM, FAST)
- Set the dB reference impedance (REF $\Omega$ ).
- Take a measurement and compare (COMP) it against a tolerance range (Hi, Lo, or Pass).
- Use the "editor" to select from option list, to enter a relative constant base, or to enter a HI-LO range for the compare (COMP) mode.
- Configure the computer interface (RS-232 or IEEE-488).
- Take an audio power reading.
- Send measurement directly to a printer or terminal through the RS-232 interface (RS-232 print only mode)



These and other front panel operations are described in the remainder of Section 3.

### 3-3 Primary and Secondary Displays

The meter has a 5 1/2 digit, Vacuum-Fluorescent dual display. This display shows measurement readings, annunciator, and messages. The annunciator indicates measurement units and the meter's operating configuration.

The dual display allows you to see two properties (e.g. Vac and frequency) of the input signal you are measuring. The display contains two major parts, primary display and secondary display (See figure 3-1).





The primary display contains of larger digits and annunciators and is located on the left side of the dual display. Readings using the relative (REL), minimum maximum (MIN MAX), touch hold (HOLD), or decibels (dBm) modifier can be shown on the primary display only.

The secondary display contains of a set of smaller digits on the right side of the dual display. To press  then followed by a function button to turn the secondary display on and press  then followed by  to turn the secondary display off.

If the secondary display has been turned on and selected a measurement function for the secondary display, the reading on the primary display will not be affected.

**NOTE**

*If user select  for the primary display, only a diode test voltage will be shown on the secondary display; continuity is restricted to the primary display only.*

Neither function modifiers , , , nor  can be selected in the secondary display.

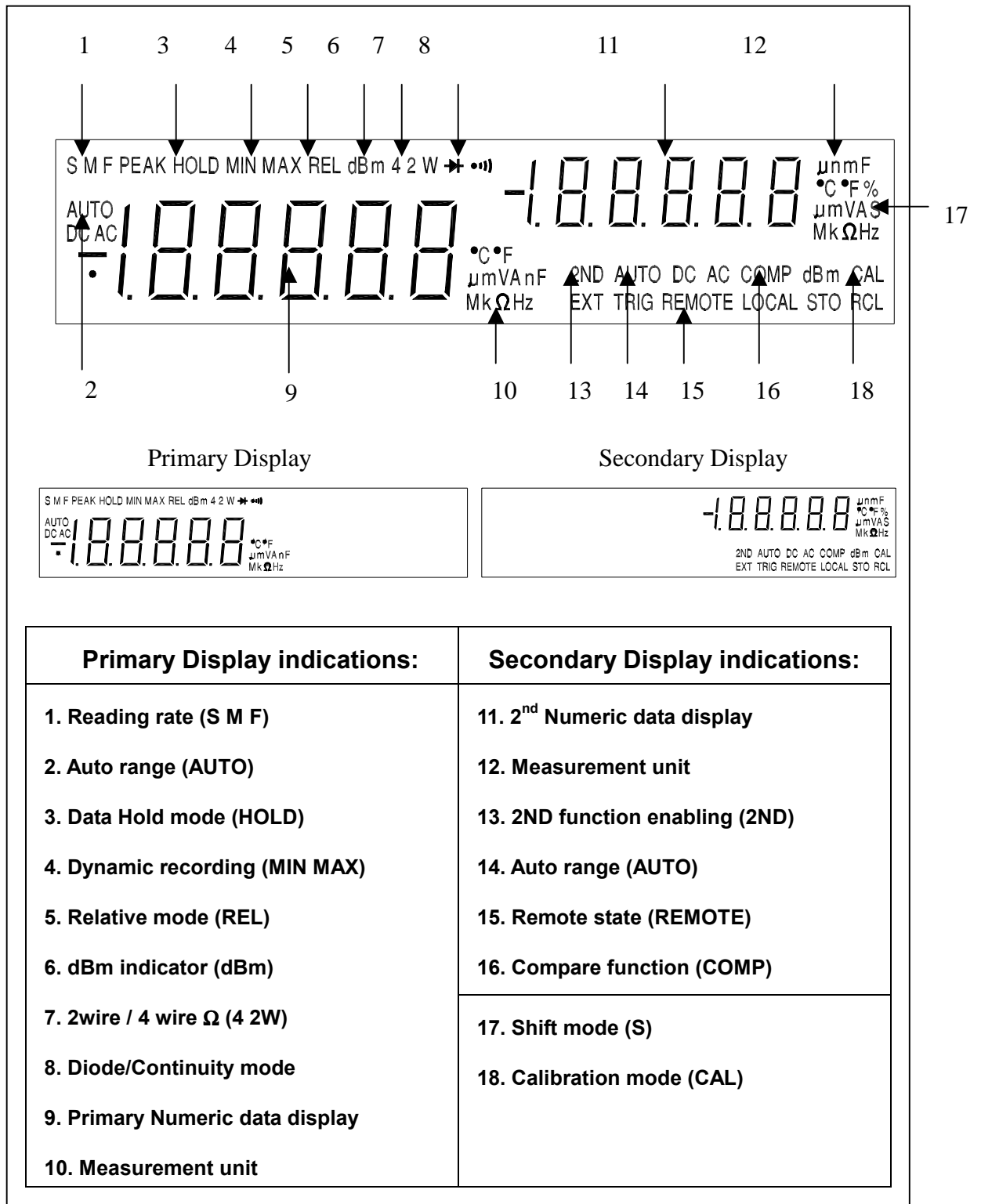

Figure 3-1 Dual Display Illustrations

### 3-4 Input Terminals

The input terminals, shown in Figure 3-2 are located on the left side of the front panel. The meter is protected against overloads up to the limits shown in Table 3-1. Exceeding these limits poses a hazard to both the meter and operator.

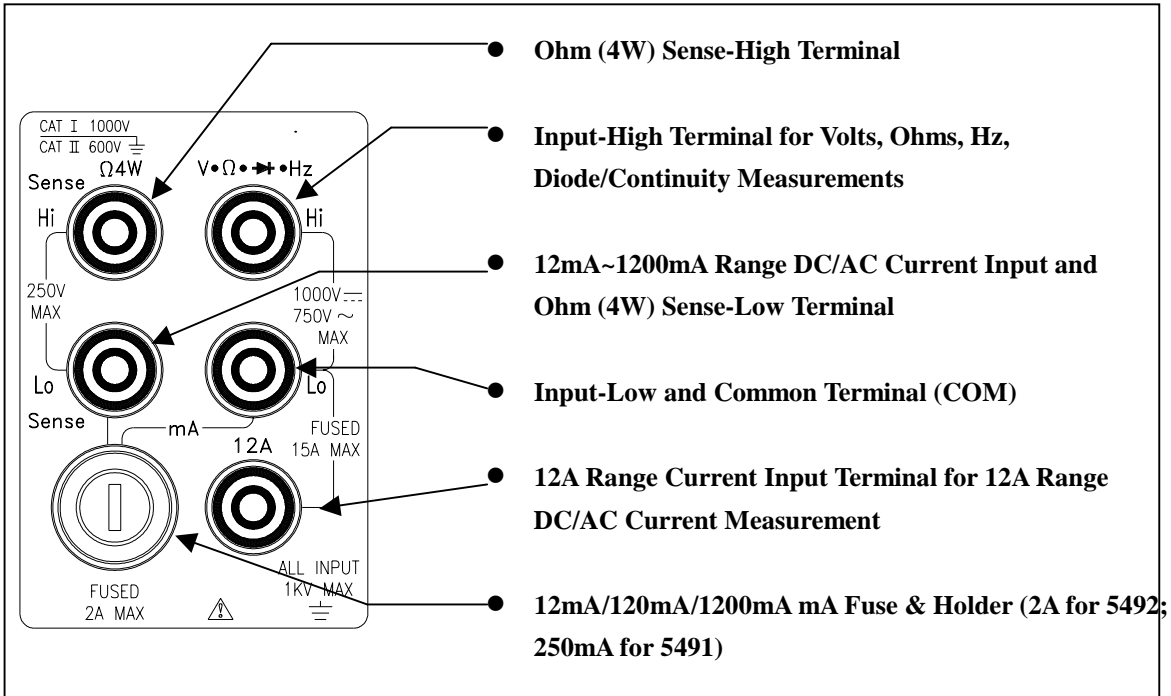

Figure 3-2 Input Terminals

Table 3-1 Input Protection Limits

Function	Input Terminal	Maximum Allowable Input
Vdc	V $\Omega$ Hz (Hi) to Lo	1000V dc
Vac, Hz	V $\Omega$ Hz (Hi) to Lo	750V ac rms, 1100V peak, $2 \times 10^7$ V-Hz normal mode, or $1 \times 10^6$ V-Hz common mode
mA, Hz	mA to Lo	1200mA <sup>(1)</sup> dc or ac rms
12A, Hz	12A to Lo	12A <sup>(2)</sup> dc or ac rms
$\Omega$ (2W)	V $\Omega$ Hz to Lo	500V dc or ac rms
$\rightarrow$ +	V $\Omega$ Hz to Lo	500V dc or ac rms
$\Omega$ (4W)	Sense Hi to Sense Lo	250V dc or ac rms
All functions	Any terminal to earth	1000V dc or peak ac
<sup>(1)</sup> Up to 1200mA for 5492; up to 120mA only for 5491		
<sup>(2)</sup> 10A dc or ac rms continuous, and 12A dc or ac rms for 30 seconds maximum		

### 3.5 Initialization of Measurement Conditions

- **Power up default configuration Status:**

When turning the meter on, it assumes its power-up configuration. The power-up configuration set at the factory is shown in Table 3-2.





As configuration data for IEEE-488 address, RS-232 baud rate, data bit, stop bit, parity, and echo are stored in the non-volatile memory, they are not changed when power is cycled off and on until the configurations are changed by the user.

**Table 3-2 Default configuration Status**

Parameters		Default Settings
Function		DCV
Range		Auto Range
Hold		OFF
Reading Rate		Slow Mode (120,000 Counts)
Arithmetic Function		OFF
Constant	Comparator	Hi: 199999 (199999E+0)
		Lo: 000000 (000000E+0)
	REFΩ (Reference Impedance)	600 Ω
	Rel # (Relative Base)	000000E+0
Secondary Display mode		OFF
CAL mode		OFF

### 3-6 Selecting A Measurement Function

Press a function button shown in Figure 3-3, to select a measurement function.

To select ac + dc total true RMS readings, press  and  or  and , simultaneously.

When user selects a function, annunciator turns on to indicate the function selected. If the secondary display has been selected and the **2ND** function annunciator remains on when a function button is pressed, the secondary display will display the reading taken from the new measurement function selected.

The summary of ranges and scale values are shown in Table 3-3 and Table 3-4 for slow rate and medium/fast rate respectively.

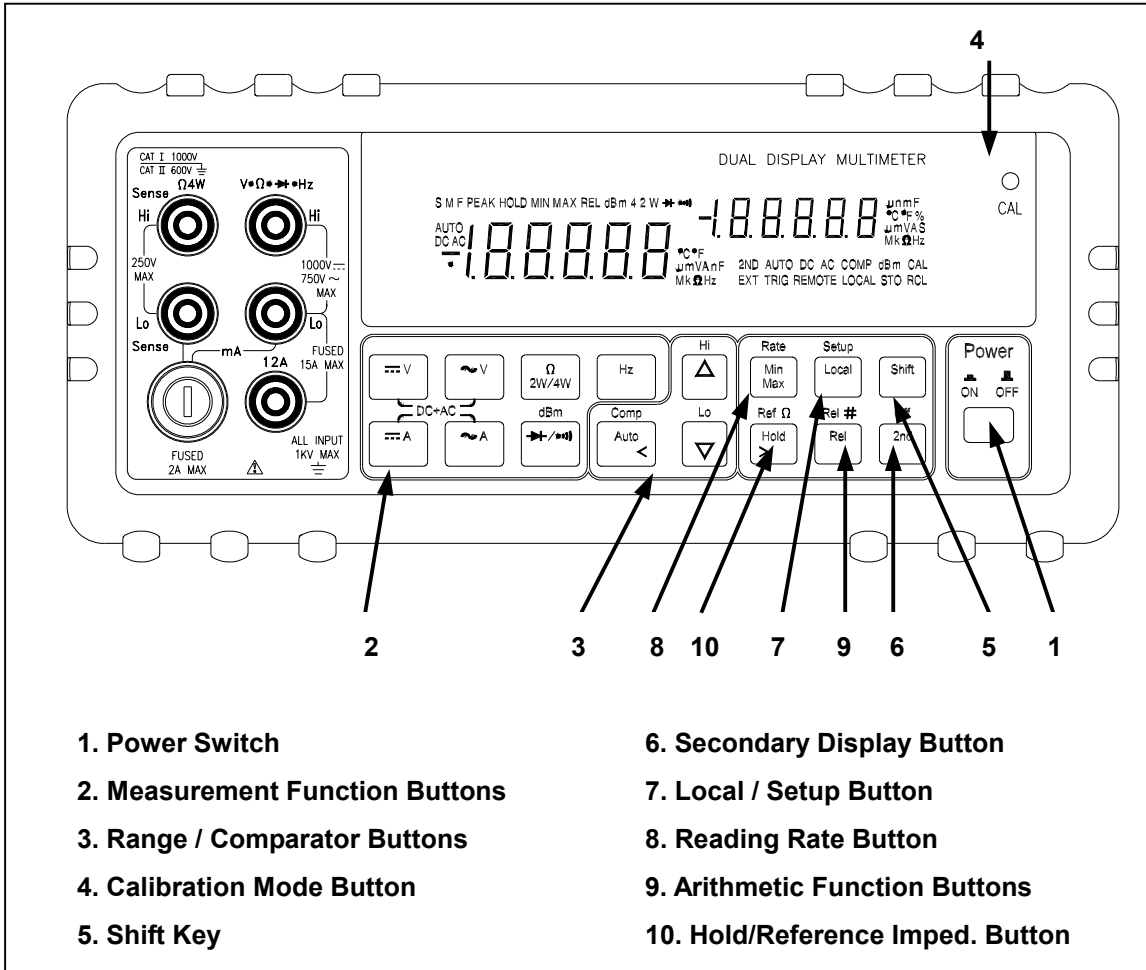

Figure 3-3 Front Panel Pushbuttons

Table 3-3 Range Scale Value in Slow Reading Rate

Function	Range Scale	Auto Ranging
$\overline{\sim}V$	120mV, 1.2V, 12V, 120V, 1000V	•
$\sim V$ , $\overline{\sim}V$ + $\sim V$	120mV, 1.2V, 12V, 120V, 750V	•
$\overline{\sim}A$ , $\sim A$ , $\overline{\sim}A$ + $\sim A$	12mA, 120mA, 1200mA <sup>(1)</sup>	•
$\overline{\sim}A$ , $\sim A$ , $\overline{\sim}A$ + $\sim A$	12A <sup>(2)</sup>	Manual only
Hz	1200Hz, 12kHz, 120kHz, 1MHz	•
$2W\Omega$ , $4W\Omega$ <sup>(3)</sup>	120, 1.2k, 12k, 120k, 1.2M, 12M, 120M $\Omega$	•
$\rightarrow \cdot \cdot \cdot \cdot \cdot \cdot$	1.2V	Fixed range
$\cdot \cdot \cdot \cdot \cdot \cdot$	2W / 120 $\Omega$ (Continuity Mode)	Fixed range

<sup>(1)</sup> 1200mA for 5492 only.  
<sup>(2)</sup> 10A dc or ac rms continuous; 12A dc or ac rms for 30 seconds maximum.  
<sup>(3)</sup> In order to eliminate the noise interference, which might be induced to the test leads, it is recommended to use a shielded test cable for measuring resistance above 120K $\Omega$ .



**Table 3-4 Range Scale Value in Medium/Fast Reading Rate**

Function	Range Scale	Auto Ranging
	400mV, 4V, 40V, 400V, 1000V	•
$\sim V$ ,  + $\sim V$	400mV, 4V, 40V, 400V, 750V	•
A, $\sim A$ ,  A + $\sim A$	40mA, 120mA, 1200mA <sup>(1)</sup>	•
A, $\sim A$ ,  A + $\sim A$	12A <sup>(2)</sup>	Manual only
Hz	1200Hz, 12kHz, 120kHz, 1MHz	•
2W $\Omega$ , 4W $\Omega$ <sup>(3)</sup>	400, 4k, 40k, 400k, 4M, 40M, 300M $\Omega$	•
	2.5V	Fixed range
	2W $\Omega$ / 120 $\Omega$ (Continuity Mode)	Fixed range
<p><sup>(1)</sup> 1200mA for 5492 only.</p> <p><sup>(2)</sup> 10A dc or ac rms continuous; 12A dc or ac rms for 30 seconds maximum.</p> <p><sup>(3)</sup> In order to eliminate the noise interference, which might be induced to the test leads, it is recommended to use a shielded test cable for measuring resistance above 120K<math>\Omega</math>.</p>		

**More operations of selecting a measurement function are described below:**

- to select DC voltage measurement
- to select AC voltage measurement
- to select DC current measurement
- to select AC current measurement
- to select frequency measurement
- to select Diode or Continuity measurements by toggling the key
- to toggle in (and out) of the 2W/4W resistance measurements mode
- then to select dBm calculation
- ( and ) simultaneously to select DC+AC RMS volts calculation
- ( and ) simultaneously to select DC+AC RMS amps calculation

### 3-7 Selecting Measurement Range ( , , and )

Ranging operations are performed by using the  ,  , and  buttons (see Figure 3-3).

Measurement ranges can be selected automatically by the meter in “Auto-ranging” or manually operated by the user.

- **Auto-Ranging**

Press  to toggle in and out of manual ranging. When meter is in auto-range mode, the AUTO annunciator is lit.

In auto-range, the meter selects the next higher range automatically when a reading is greater than full scale. If no higher range is available, ‘OL’ (overload) will be displayed on primary or secondary display. Likewise, the meter will automatically selects a lower range when a reading is less than approximately 9.5% of the full scale.



- **Manual Range**

Press  to toggle in and out of manual ranging. The range user is in will become the selected range when user enters the manual range mode. In manual range, the meter remains in the selected range regardless of input.

Press  to toggle back to auto-ranging. Manual range can be performed either on readings shown in the primary display or secondary display.



- **Selecting A Measurement Range**

**To manually select a range,**

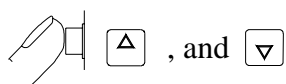
-   to toggle in (and out) of the manual ranging mode, or





**In manual range mode,**

-   , and  to select higher range or lower range to the desired one.



### 3-8 Selecting Measurement Rate (Rate)

The meter takes measurements at one of three user-selectable rates: **SLOW**, **MEDIUM**, and **FAST**. Rate selection allows user to maximize either measurement speed or noise rejection, which affects accuracy (see Table 3-5). The annunciators “**S**”, “**M**”, and “**F**” (slow, medium, and fast, respectively) indicates selected rate on the primary display.

-   then  to select the different reading rate of measurement.

The meter will be operated in one of the three reading rates sequentially (**S** → **M** → **F** → **S** → **M** → **F**, etc.) if user repeats the above procedures once after the other.

**Table 3-5. Display Reading Rates for Single Function Measurements**

Reading Rate	Digits	Display Counts <sup>(1,2)</sup>	Readings per Second
<b>SLOW</b>	5 1/2	119,999	2
<b>MEDIUM</b>	4 1/2	39,999	5
<b>FAST</b>	3 1/2	3,999	20







(1) In Vdc 1000V range, display counts will be limited up to 1200.00, 1200.0 and 1200 for slow, medium and fast reading rate respectively;  
 (2) In Vac 750V range, 1000Vrms is readable

*Note: 1. The reading rate is not selectable when using Frequency function.*

*Note: 2. At dBm function enable, 0.01dBm resolution for Slow or Medium rate and 0.1dBm for Fast rate.*

### 3-9 Selecting Secondary Display

- **To Enable the Secondary Display Mode**

  then function buttons (  ,  ,  ,  , and  )

to enable the secondary display mode.

The  annunciator is in the secondary display area.

- **To Disable the Secondary Display Mode**

  then  to disable the secondary display mode.

The  annunciator is off in the secondary display area. The display remains in **Primary display mode**

● **Combination of Dual Display Settings**

Table 3-6 provides the available combination of inputs for the primary display and secondary display in the dual display mode.



**Table 3-6. Descriptions for Combination of Dual Display**



Secondary Display Primary Display	Vdc	Vac	Adc	Aac	Hz
Vdc	●	●	●	●	●
Vac	●	● (1)	●	●	●
Adc	●	●	●	●	● *2
Aac	●	●	●	● (1)	● *2
Vac + Vdc	●	● (1)	●	●	●
Aac + Adc	●	●	●	● (1)	● (2)
Hz	●	●	● (2)	● (2)	● (1)
$\Omega$ (3)	●	●	●	●	●
▶ (1)	●	●	●	●	●
dBm	●	●	●	●	●
<p>(1) The ranges of the secondary display are set by the primary display.</p> <p>(2) The Frequency reading is corresponding to the current input signals; other readings are corresponding to the voltage input signals.</p> <p>(3) It is recommended to measure the resistance up to 1M <math>\Omega</math> in dual display mode.</p>					



*Note:* In dual display mode, keystroke response time is approximately 0.6 ~ 1 second. User may need to select and press down a key until the meter responding to the Keystroke.

### 3-10 Entering Setup Mode

User may select computer interface, set RS-232 interface (standard) or GPIB interface (option), and beeper mode on Setup Mode. To ensure the remote interface will operate appropriately, user may need to configure the remote interface parameters by following the procedures as shown below:

 **Shift** then  to enter the **setup mode** to configure the remote interface parameters.

 or  to select the each tier menu items.

 or  to select the parameters of the menu item.

 to enter second tier menu or to store the selected parameter. The selected parameter is flashed in primary display.

 to quit the tier menu. To quit from the setup mode and this will save all parameter settings.

Table 3-7 describes the outline of the setup menu item. Some menu items will be not displayed without GPIB interface meter (option).

**Table 3-7. Descriptions for Outline of Setup Menu Item**

First Tier Menu	Second Tier Menu
1. Remote Mode Selection <sup>(1)</sup>	
2. RS-232 Interface Parameters	1. Baud Rate 2. Parity 3. Data Bit 4. Stop Bit 5. ECHO 6. Printer-Only
3. GPIB Interface Parameters <sup>(1)</sup>	1. Address <sup>(1)</sup> 2. Talk <sup>(1)</sup>
4. Beeper Mode Selection	
<sup>(1)</sup> The items will be displayed when GPIB option is installed.	

Table 3-8 indicates the factory settings and user selectable communication parameters by using RS-232 interface (standard) and GPIB interface (option).

**Table 3-8. Communication Parameters**

Menu Item	Factory Setting	Selectable Parameters
Remote	RS-232	RS-232 or GPIB
Baud Rate	9600	9600, 4800, 2400, 1200, 600, and 300
Parity	None	None, Odd or Even
Data Bit	8	7 or 8
Stop Bit	1	1 or 2
ECHO	OFF	ON or OFF
Printer-Only	OFF	ON or OFF
Address	8	0 to 30
Talk	OFF	ON or OFF
Beeper <sup>(1)</sup>	ON	ON or OFF
<sup>(1)</sup> The Beeper mode is not a communication related parameter but to simplify the meter operation.		

### 3-11 Selecting Local Operation Mode



to return the operation control priority from remote mode (computer controlled) to local mode (user controlled).

## 3-12 Operating Arithmetic Functions

- **Using dBm Modifier**

The dBm measurement is used for decibel conversion of power per 1mW consumption into a 600Ω load and can be applied to Vdc and Vac measurement functions only. Voltage measurement is converted to dBm by using the following formula:

$$\text{dBm} = 10x \log_{10} [1000 x (\text{measurement value})^2 / \text{reference impedance}]$$



Shift



then

dBm



to toggle in (and out) dBm modifier mode when measuring

Vdc or Vac function with default reference impedance 600Ω.

The meter will display the dBm modifier on the primary display and displays the reference impedance on the secondary display.

User may then use  and  to rotate the selection of different impedance as desired when the selection mode is enabled, the reference impedance selection is shown on the secondary display area.

- **Selecting Reference Impedance for dBm Modifier**



 **Shift** then  to toggle in (and out) the Reference Impedance selection mode.



Any of the following 21 types of reference impedance may be selected:  
 8000Ω, 1200Ω, 1000Ω, 900Ω, 800Ω, 600Ω, 500Ω, 300Ω, 250Ω, 150Ω,  
 135Ω, 125Ω, 124Ω, 110Ω, 93Ω, 75Ω, 50Ω, 16Ω, 8Ω, 4Ω, 2Ω

If reference impedance 2, 4, 8, or 16Ω is selected, the dBm modifier is displayed in Watts (power).

- **Operation procedures:**

- **Condition 1:**

 **Shift** then  , the reference impedance currently used will be displayed on the secondary display.



 **▲** or  to scroll to the desired value of reference impedance.

 **Shift** to store the selected value.

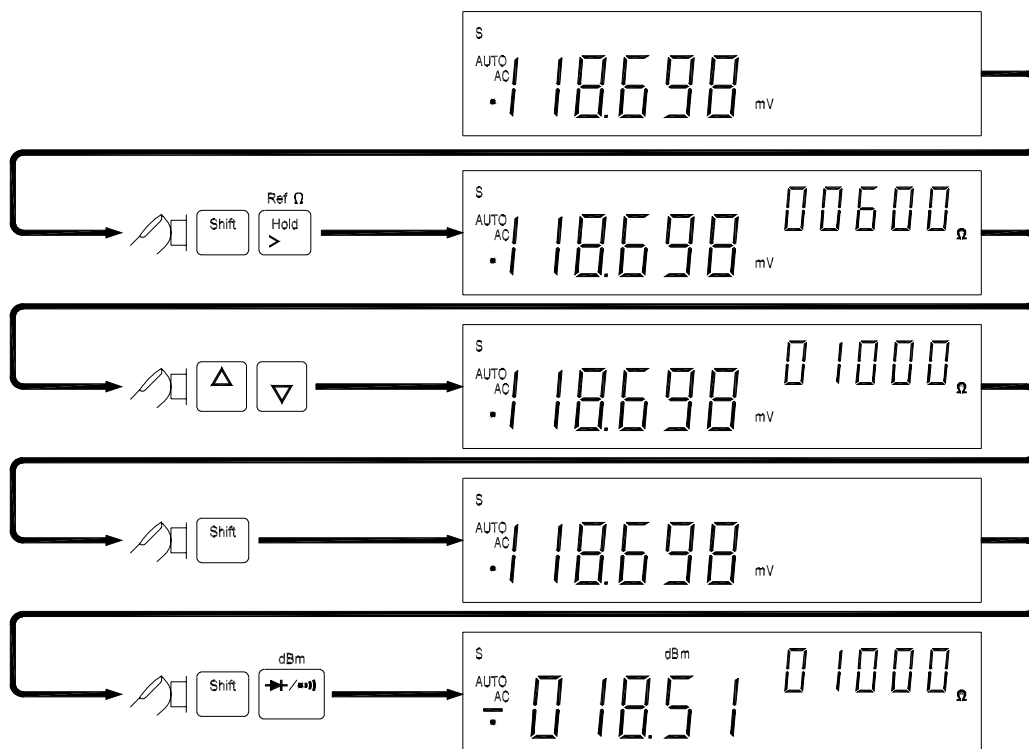
- **Operation Example:** Set the reference impedance to 1000Ω for dBm calculation.



### Condition 2:

 **Shift** then  to enter dBm calculation mode.

 **▲** or **▼** to scroll to the desired impedance value shown as the following operation example.

#### • Operation Example:

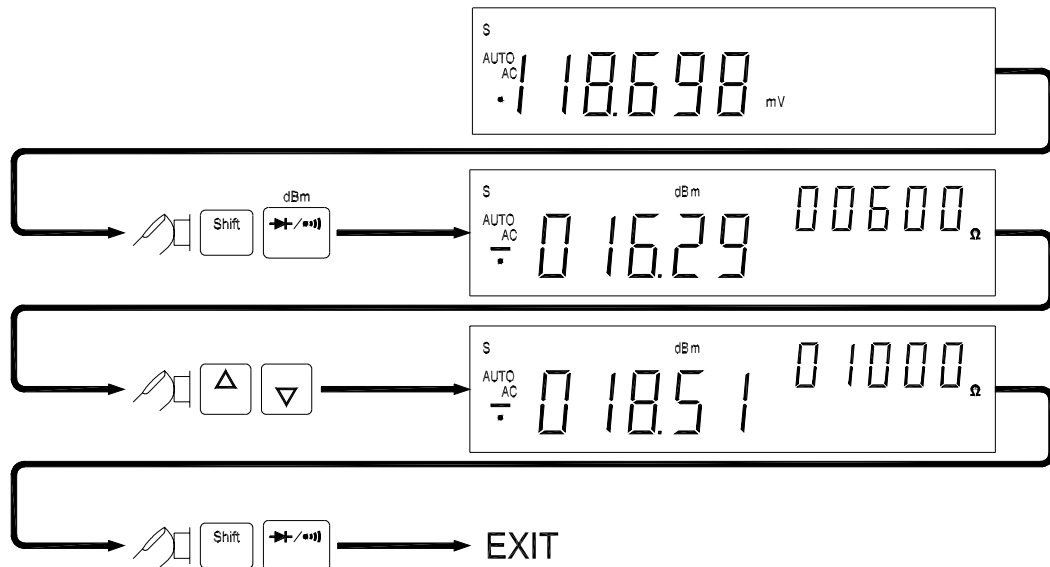

#### • Using MINMAX Modifier for Dynamic Recording

“MINMAX” modifier enables the meter to store the minimum and the maximum input signals measured since the “MINMAX” modifier was selected. The definitions of “MIN” and “MAX” are defined as follows:

**MIN: Minimum value of calculation results for measured signal**

**MAX: Maximum value of calculation results**

If “MAX” modifier is selected, the display indicates the latest maximum reading until next measurement reading exceeds the previous recorded reading.

If “MIN” modifier is selected, the display indicates the latest minimum reading until next measurement reading drops below the previous recorded reading.

If “MINMAX” mode is selected, the display indicates the actual value of input signal.

**Note: 1.** When “MINMAX” dynamic recording mode is selected, the measurement range will be changed to the manual range and will be locked on the current measurement range until the “MINMAX” mode is disabled and user selects other ranges or auto-ranging mode is enabled.



**Note: 2.** If the beep mode is set to “ON”, the beeper will emit a single tone when an effective maximum or minimum value is recorded.

● **Operation Procedures**

 **Min Max** to enable “MINMAX” modifier.

The recording mode will rotate as the following sequences if keep pressing

the  key: **Max** → **MinMax** → **Min** → **MinMax** → **Max**

 **Shift** then  to disable “MINMAX” modifier.

● **Operation Example**

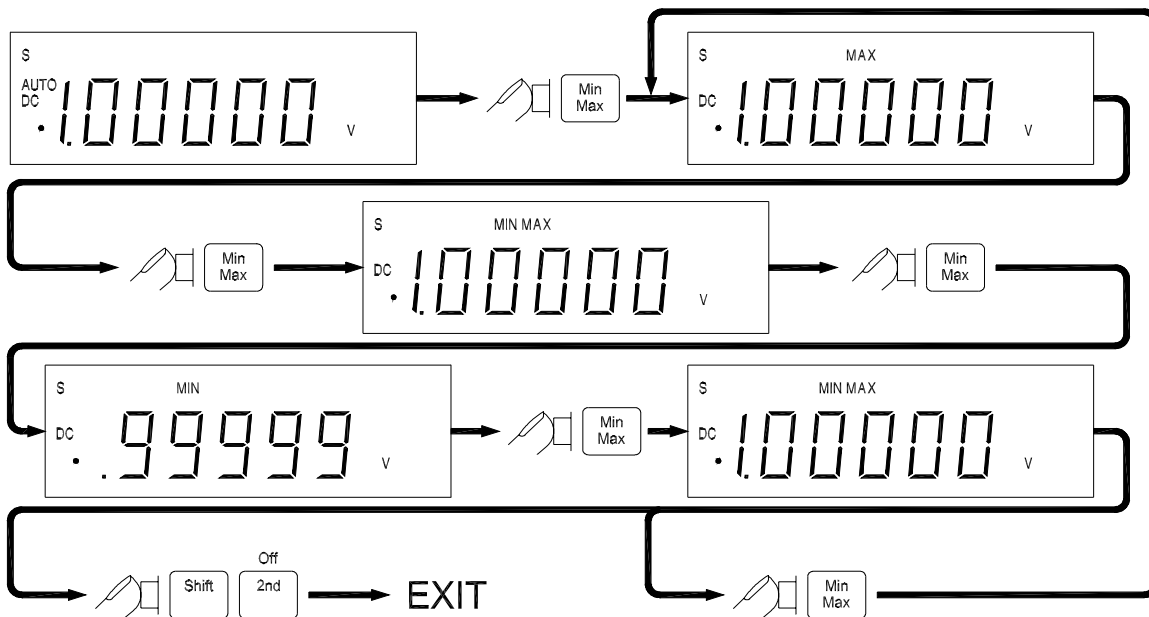

● **Selecting HOLD (Data Hold) Modifier**

The Data Hold function allows user to freeze the display.

This feature is useful when user wants to keep the current measurement reading, user may press **HOLD** to freeze the display and then read the display reading without losing the reading.

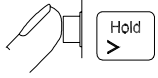

- **Operation Procedures**

 to enable Data Hold mode, and the annunciator **HOLD** will be shown on the primary display.

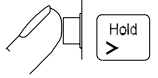
 again to disable Data Hold mode.

*Note: The Data Hold mode can be used for other arithmetic functions such as dBm, REL and Min / Max.*

- **Selecting REL (Relative) Modifier**

When the “**REL**” modifier is selected, the reading on the primary display is the value difference between Rel# (relative base) and the current measurement value.

The definitions of “**REL**” modifier is defined as follows:



$$\text{Displayed reading} = \text{Measurement value} - \text{Rel\#}$$



*Note: The relative function can be selected for primary display only.*

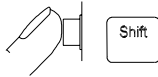

- **Setting Rel# (Relative Base) for REL Modifier**

 to enable the “**REL**” modifier and the primary display reading will be stored as a relative base. The primary display will then be zeroed and **REL** annunciator will be lit on the primary display. The secondary display will not be affected.

**When “REL” modifier is selected,**

 then  to toggle in (and out) the relative base (REL#) selection.

Annunciator **REL** is lit on the primary display then using (  ,  ,  ,

 and  ) to change the relative base value for “**REL**” modifier calculation.

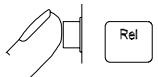
 again to disable “**REL**” modifier.

- **Operation Example:** To enable “REL” modifier for Vdc measurement.

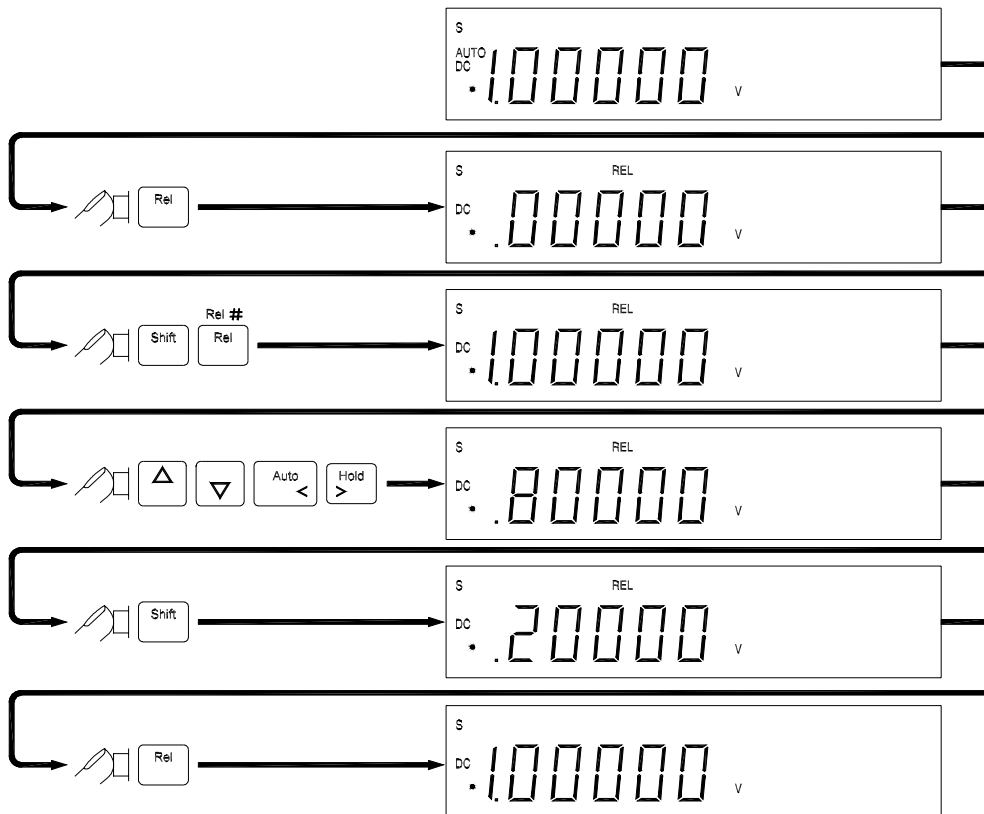

- **Using COMP (Compare) Function**

“COMP” function compares the measurement inputs with the pre-set upper and lower limits. The compare function calculation expression is based on counts without decimal point.

**HI:** Measurement value > High (HI) limit value

**LO:** Measurement value < Low (LO) limit value

**PASS:** High limit value  $\geq$  Measurement value  $\geq$  Low limit value

When “COMP” function is enabled, the actual measurement value will be shown in primary display and a comparison result “HI”, “LO”, or “PASS” will be shown in secondary display.

- **Operation Procedures**

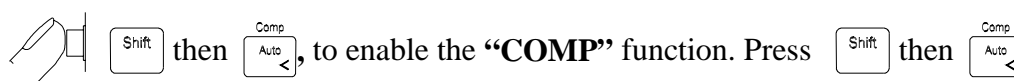

again to disable the compare function.

- **Setting a Compare Limit Value**

Using the following procedure to set the high and the low limit values for “COMP” function:

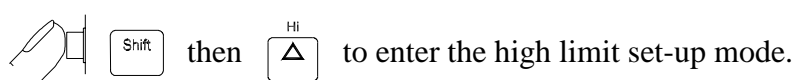

The upper limit will be shown in primary display.

 **Auto** < , **▲** , **▼** or **Hold** > to change this value.

 **Shift** to store the high limit value in counts.

 **Shift** then **Lo** **▼** and repeat the above steps to set and store the lower limit value.

**Note: 1.** After the upper and/or the lower limits (counts) have been set up, the upper and/or the lower limits can be used for all ranges. However, at different range, the upper and/or the lower limits represent different values according to their respective counts.

**Note: 2.** The Compare function can be used with other arithmetic functions such as **REL**, **MINMAX**, and **dBm** modifiers.

● **Operation Example:**

Setting up the compare limits “HI”, “LO”, or “PASS” for Vdc measurement.

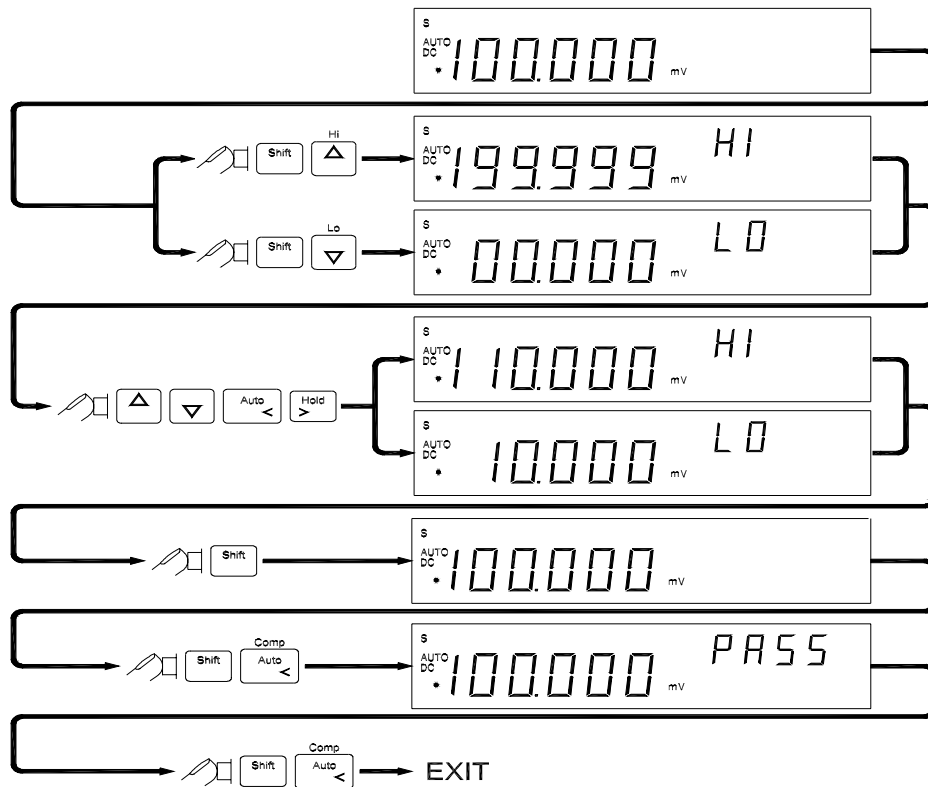

### 3-13 Combinations of Arithmetic Functions

The meter allows the user to use multiple arithmetic functions (dBm, MINMAX, REL, HOLD, and COMP) simultaneously. The result of one arithmetic function can be computed again as shown in the following operation procedure flowchart.

**Example:** Using the following procedures to set the upper and the lower limit values for “COMP” function.

When using the multiple arithmetic functions, any types of modifier calculation can be combined together as the operations shown above. For example, if Rel is selected while dBm modifier is enabled, the result of the dBm calculation (①) becomes a relative base (②) for new measurements. The sequences and the results of the combined arithmetic functions are shown in Table 3-9 step by step when all types of arithmetic functions are activated sequentially as shown in above example.

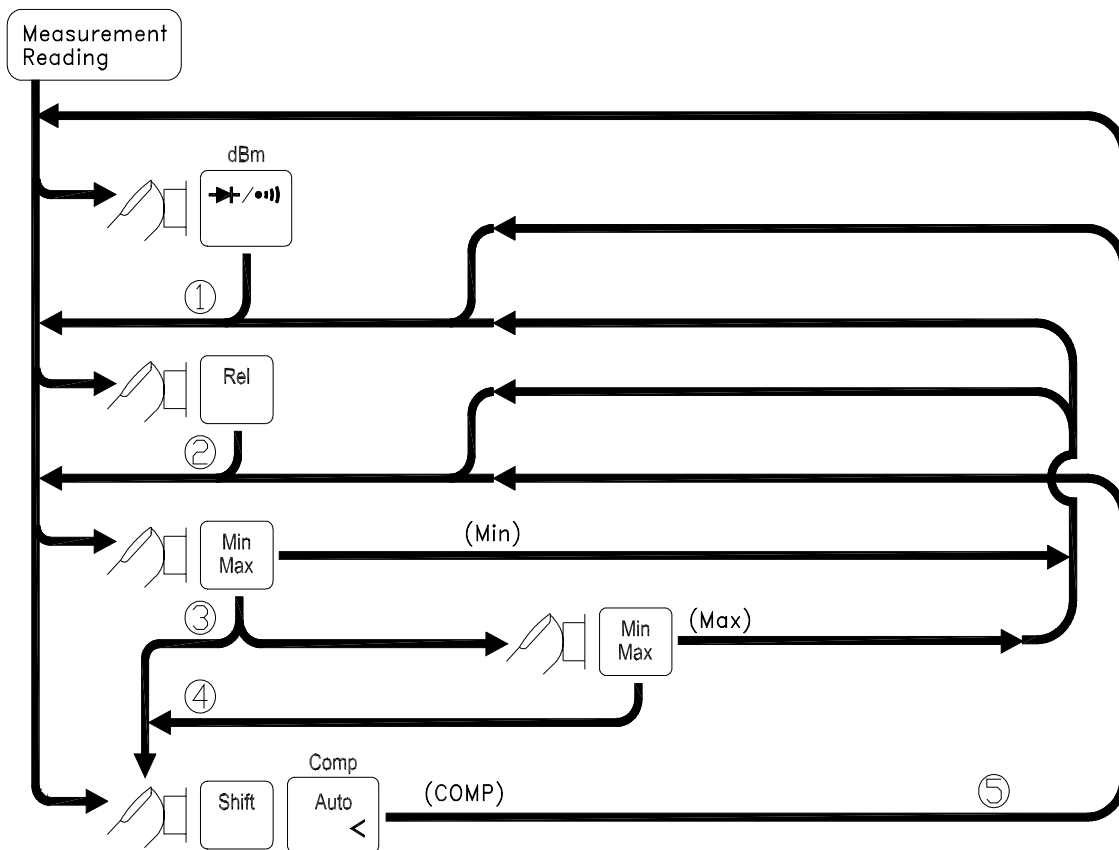

*Note: Arithmetic functions can be operated for primary display only.*

**Table 3-9. Descriptions for Combined Arithmetic Functions**

Arithmetic Function Operation Sequence		Description	Result Generated
1	dBm	The measurement value is calculated to a dBm modifier	①
2	REL	dBm result (①) is taken as a REL base	②
3	Min	Min value of relative dB is recorded as a new REL base (②)	③
4	Max	Max value of relative dB is recorded as a new REL base (②)	④
5	COMP	A COMP is performed to based on the results of ③ and ④	⑤

### 3-14 Entering Calibration Mode

 **CAUTION!**

TO AVOID DAMAGING THE DEFAULT CALIBRATION DATA STORED IN NON-VOLATILE MEMORY, A CALIBRATION TO THE METER CAN ONLY BE DONE BY AN AUTHORIZED SERVICE CENTER WITH APPROPRIATE EQUIPMENT.

THE WARRANTY IS NOT GUARANTEED IF THE SEALED LABEL ON THE CAL BUTTON LOCATED ON THE FRONT PANEL DISPLAY SCREEN IS BROKEN.

FOR MORE INFORMATION ABOUT CALIBRATION, REFER TO SECTION 5 "CALIBRATING THE METER".

The meter is designed with closed-case calibration capability (no internal adjustment). To enter calibration mode by pressing the CAL button located on the upper right position of the front panel.

(This page is subject to be blank)

## Measurement Application Examples

### 4-1 Introduction

Section 4 describes some advanced features and applications that help the user to operate the meter more effectively. The user must be familiar with the basic measurement operations described in Section 2 and Section 3 and has a basic understanding of electronics knowledge.

### 4-2 Applications for Using Dual Display

The dual display capability is one of the most useful features provided with the meter. User may take the advantages to greatly enhance the test and measurement capabilities.

Some common combinations and applications of using dual display are provided in Table 4-1.

**Table 4-1. Typical Combinations and Applications for Using Dual Display**

Primary Display	Secondary Display	Applications
Vdc	Vac	• Testing DC to AC or AC to DC converter circuit
Vac+Vdc	Vdc	• Measuring DC level and AC ripple of power supply
Vdc	Adc	• Testing power supply load regulation
Vdc	Aac	• Checking loop current and voltage drop level
Aac+Adc	Vdc	• Testing line and load regulation
Vac	Adc	• Testing AC to DC or DC to AC converters
Aac+Adc	Vac	• Measuring DC level and AC ripple of power supply
Vac	Aac	• Testing transformer
Vac	Hz	• Measuring AC frequency response of amplifier circuit
Aac	Hz	• Adjusting AC motor control
Adc	Aac	• Measuring AC ripple and DC current of power supply
Aac+Adc	Adc	• Measuring current dissipation for power supply analysis
dBm	Reference $\Omega$	• Setting dB reference impedance and show dBm
dBm	Vdc	• Indicating DC voltage and dBm
dBm	Vac	• Indicating AC voltage and dBm
dBm	Hz	• Checking frequency response

## 4-2-1 Dual Display Operation Examples

This section will describe some practical operations of using dual display features.

- **Measuring DC voltage and AC ripple on a rectification circuit.**

To display DC voltage in primary display, and AC voltage in secondary display or vice versus while testing a rectifier circuit, user may check the DC voltage supplied and its AC ripples by taking a single measurement.

1. Connect the meter to the unit under test as shown below:

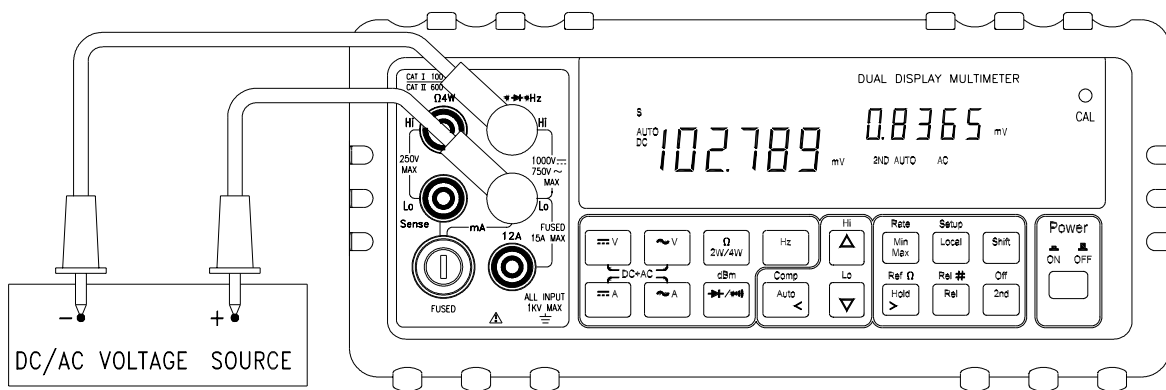

2. to select DC voltage measurement function for primary display.
3. , or to select auto-ranging or manual range for primary display.
4. to turn on “ 2ND ” annunciator in secondary display.
5. to select AC voltage measurement function for secondary display.
6. , or to select auto-ranging or manual range for secondary display.

**Note: 1.** Press then may turn off secondary display.

**Note: 2** Press to select the suitable range, if the DCV + AC ripple is over the scale of current range.

**Note: 3.** Regarding secondary display function setting, please refer to Section 3-10.



- **Measuring AC and DC current on a rectification circuit.**

To display AC current in primary display and DC current in secondary display or vice versus while testing a rectifier circuit, user may check the DC current component and its AC ripples by taking a single measurement.

1. Connect the meter to the unit under test as shown below:

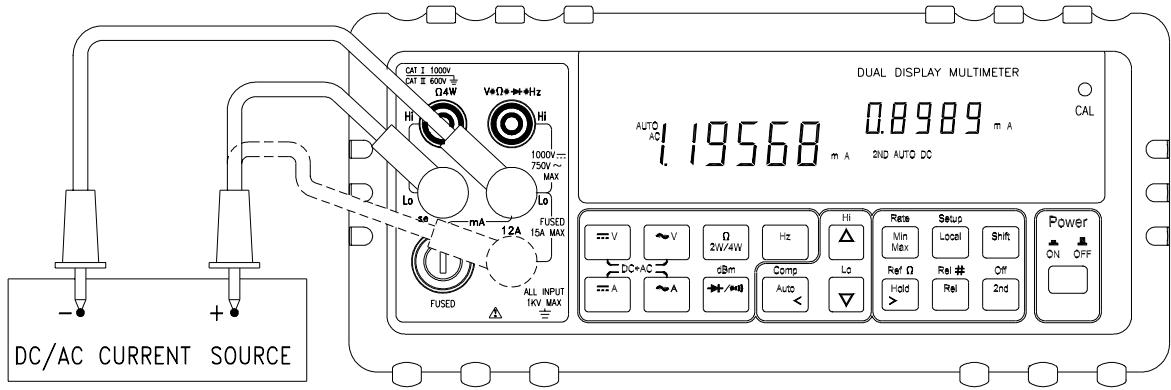

**⚠ WARNING!**

1. Select a correct input terminal according to the input range to be used.
2. To avoid damaging the meter do not apply more than 12A to “12A” input terminal.

2. to select AC current measurement function for primary display.
3. , or to select auto-ranging or manual range for primary display.
4. to turn on “**2ND**” annunciator in secondary display.
5. to select DC current measurement function for secondary display.
6. , or to select auto-ranging or manual range for secondary display.

**Note: 1.** Press then may turn off secondary display.

**Note: 2.** Regarding secondary display function setting, please refer to Section 3-10.

- **Measuring AC voltage and frequency on an AC circuit.**

To display AC voltage in primary display and the frequency in secondary display or vice versus while measuring an AC signal, user may check AC voltage and its frequency of an AC Power Supply or circuit by taking a single measurement.

1. Connect the meter to the unit under test as shown below:

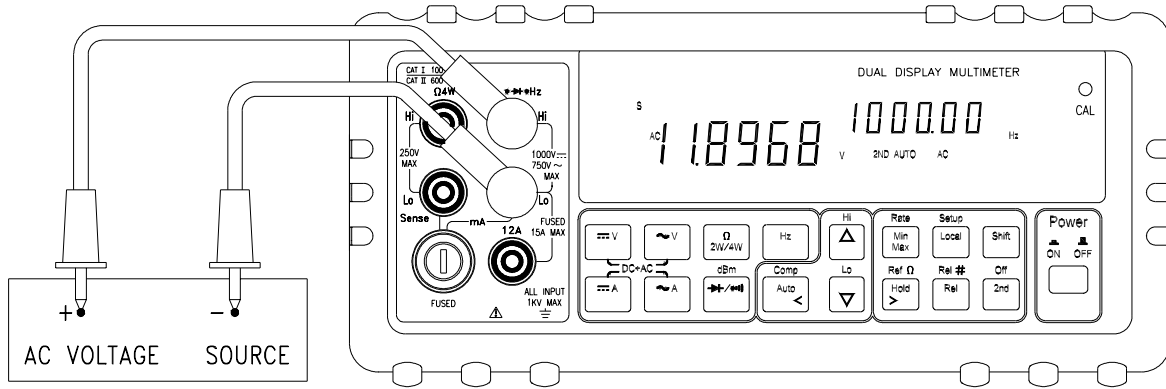

2. to select AC voltage measurement function for primary display.
3. , or to select auto-ranging or manual range for primary display.
4. to turn on “**2ND**” annunciator in secondary display.
5. to select Frequency (Hz) measurement function for secondary display.
6. , or to select auto-ranging or manual range for secondary display.

**Note: 1.** Press then may turn off secondary display.

**Note: 2.** Regarding secondary display function setting, please refer to Section 3-10.

- **Measuring DC voltage and DC current on a transistor circuit or load.**

To display DC voltage in primary display and the frequency in secondary display or vice versus while testing a transistor amplifier circuit, user may check its  $H_{fe}$  or calculate its DC load consumption by using dual display.

1. Connect the meter to the unit under test as shown below:

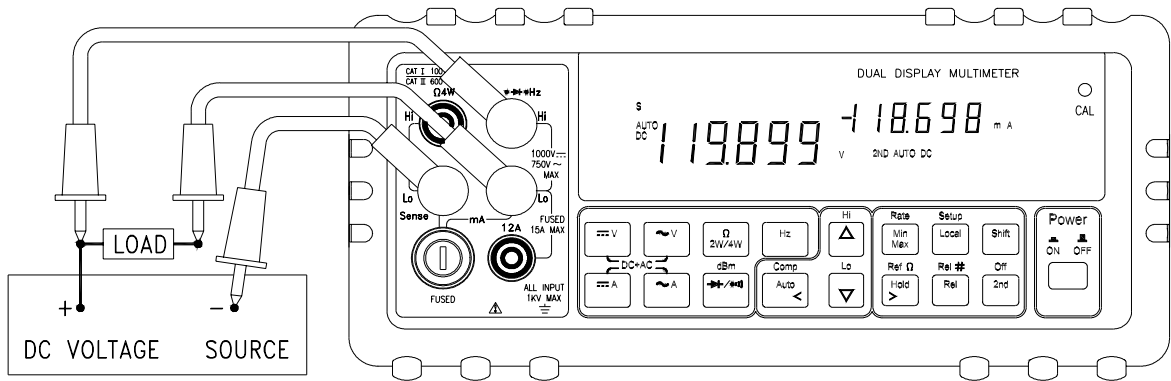

**⚠ WARNING!**

1. Select a correct input terminal according to the input range to be used.
2. To avoid damaging the meter do not apply more than 12A to “12A” input terminal.

2. to select AC voltage measurement function for primary display.
3. , or to select auto-ranging or manual range for primary display.
4. to turn on “**2ND**” annunciator in secondary display.
5. to select Frequency (Hz) measurement function for secondary display.
6. , or to select auto-ranging or manual range for secondary display.

**Note: 1.** Press then may turn off secondary display.

**Note: 2.** Regarding secondary display function setting, please refer to Section 3-10.



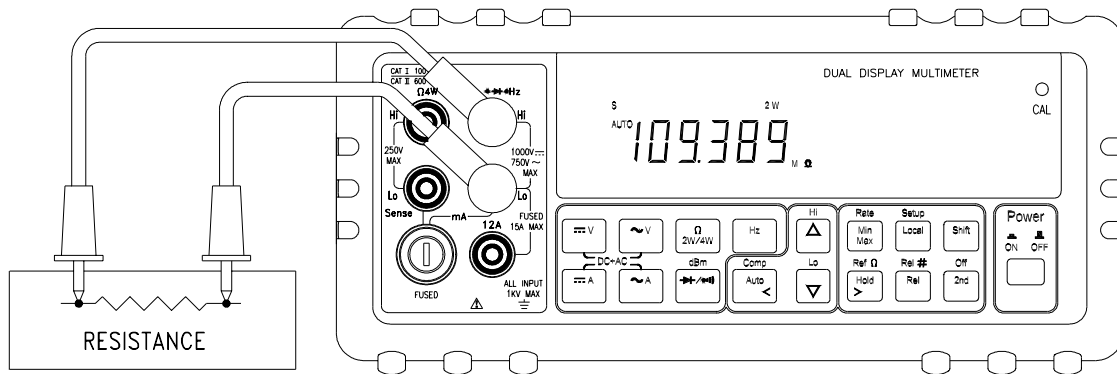

## 4-3 Measuring Resistance by using 2-wire Mode

1. Connect a resistor under test to **V•Ω•Hz** and **Lo** input terminals as shown below:



### **⚠ WARNING!**

*Do not apply a voltage exceeding 500 V peak between **V•Ω•Hz** and **Lo** input terminals.*

2.  **Ω 2W/4W** to select the 2-wire  $\Omega$  measurement function, **2 W** annunciator will be on in the primary display.
3. ,  or  to select auto-ranging or manual range for primary display.

**Note:** When measuring low resistance, use “REL” modifier function to reduce the measurement error created by the test leads resistance and contact resistance in the test loop ( $0.1\Omega \sim 0.5\Omega$  typical).

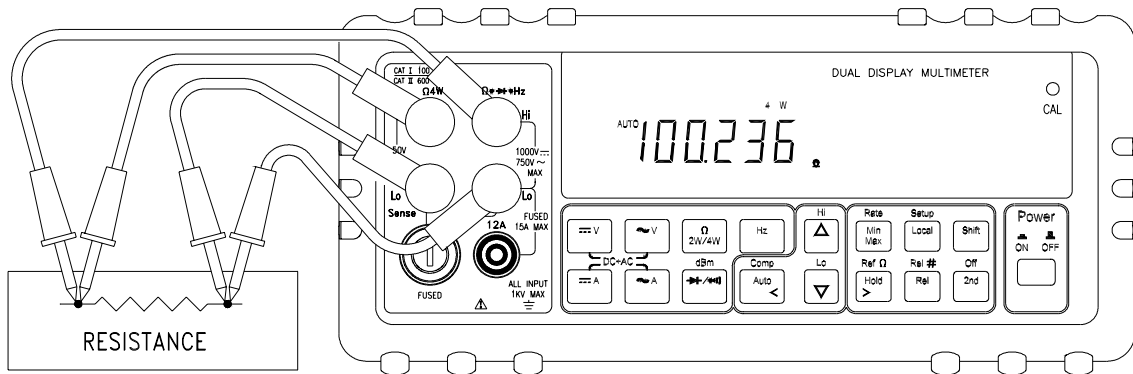

## 4-4 Measuring Resistance by using 4-wire Mode

1. To measure resistance using 4-wire mode, firstly connect two test leads from **V•Ω•Hz** and **Sense-Hi** terminals to one side of the resistor under test, and then connect the other two test leads from **Lo** and **Sense-Lo** terminals to the other side of the resistor under test as shown below:







### **⚠ WARNING!**

*Do not apply a voltage exceeding 250 V peak between **Sense Hi** and **Sense Lo** terminals, and 500 V peak between **V•Ω•Hz** and **Lo** input terminals.*

2.  **Ω 2W/4W** to select 4-wire  $\Omega$  measurement function, **4 W** annunciator will be on in the primary display.
3.  **Auto** , **▲** or **▼** to select auto-ranging or manual range for primary display.

## 4-5 Measuring True RMS AC+DC

The meter can measure the true rms value of ac voltages and currents.

When  and  or  and  are pressed simultaneously, the meter will measure the dc and ac signals alternatively then calculate and display the ac+dc rms value by using the following formula:

$$(\text{ac+dc}) \text{ RMS} = \sqrt{dc^2 + ac^2}$$

**Note:** When voltage (ac+dc) measurement function is selected, the Vdc input impedance is paralleled with an ac-coupled 1.1MΩ ac divider.

- **Measurement example:**

To take a true rms voltage ac+dc measurement on an ac signal, assuming the input ac is 10V<sub>rms</sub> 1kHz sine wave ac signal and with a dc offset voltage +5 volts, the meter will read and display the results approximately as:

$$\sqrt{5^2 + 10^2} \quad 11.1803 \text{ volts}$$

## Section 5

# Calibrating the Meter

### 5-1 Introduction

 **CAUTION!**

TO AVOID DAMAGING THE DEFAULT CALIBRATION DATA STORED IN A NON-VOLATILE MEMORY, A CALIBRATION TO THE METER CAN ONLY BE DONE BY AN AUTHORIZED SERVICE CENTER AND QUALIFIED PERSONNEL WITH APPROPRIATE EQUIPMENT.

THE WARRANTY WILL BE EXPIRED IF THE SEALED LABEL ON THE CAL BUTTON OF THE FRONT PANEL IS BROKEN.

FOR MORE DETAIL INFORMATION ABOUT CALIBRATION PROCEDURES, PLEASE CONTACT FACTORY OR AUTHORIZED DISTRIBUTOR.

It is recommended to recalibrate and verify the meter at least once a year to ensure it meets the original designed performance and specifications.

The meter is designed with closed-case calibration capability (no internal adjustment). To enter calibration mode by pressing the CAL button located in the hole on the upper right position of the front panel display screen.

The meter can be calibrated and verified by keystrokes via the front panel or through RS-232 interface (or optional IEEE-488) command with appropriate equipment and qualified personnel only.

### 5-2 Environmental Condition

Calibration or verification test should be performed under laboratory condition with an ambient temperature of 19-26 °C and a relative humidity of below 75%.

### 5-3 Warm up

Allow up to at least 60 minutes warm-up time before performing calibration or a verification test to the meter. After exposure or storage in a high humidity (condensing) environment, 2 hours warm-up time is essentially required.

#### 5-4 Recommended Test Equipment

The test equipment requirements listed in Table 5-1 or equivalents are required to perform the calibration and performance verification test procedures. Alternative equipment may be used as long as the accuracy is at least as good as those listed.

**Table 5-1 Standard Equipment Requirements**

Standard Source	Operating Range	Accuracy Required	Recommended Equipment
DC Voltage Calibrator	Range, 0 to 1000VDC	$\leq \pm 0.002\%$	Fluke 5520A or equivalent
AC Voltage Calibrator	Range, 0 to 750V, 1kHz	$\leq \pm 0.03\%$	Fluke 5520A or equivalent
DC Current Calibrator	10mA to 100mA	$\leq \pm 0.01\%$	Fluke 5520A or equivalent
	1A to 10A	$\leq \pm 0.03\%$	
AC Current Calibrator	10mA to 1000mA, 1kHz	$\leq \pm 0.1\%$	Fluke 5520A or equivalent
	1A to 10A, 1kHz	$\leq \pm 0.2\%$	
Resistance Calibrator	100 $\Omega$ , 360 $\Omega$ , 1k $\Omega$ , 3.6k, 10k $\Omega$ , 36k $\Omega$ , 100k $\Omega$ , 360k $\Omega$ , 1M $\Omega$ , 3.6M $\Omega$	$\leq \pm 0.01\%$	Fluke 5520A or equivalent
	10M $\Omega$ , 20M $\Omega$ ,	$\leq \pm 0.05\%$	Fluke 5520A or equivalent
	100M $\Omega$ , 200M $\Omega$	$\leq \pm 0.5\%$	
Audio Level Generator	1V/1000Hz	$\leq \pm 0.001\%$	Fluke 5520A or equivalent



## Section 6

# RS-232 Remote Operation

### 6-1 Introduction

Section 6 describes how to operate the meter via standard RS-232 interface. It also explains the detail information of all RS-232 interface command sets used in the meter. The remote control operation enables the user either to manually operate the meter via a terminal or executes a host computer program automatically.

### 6-2 RS-232 Interface Overview

The port serial contains of D-type 9-pin male connector on rear panel of the meter is used to communicate the meter with a host computer, or terminal via RS-232 standard interface. Figure 6-1 shows the RS-232 connecting diagram between the meter and a host computer.

RS-232 interface is a serial binary data interchange, which operates from 300 to 9600 baud rate and the distance between any two RS-232 interface can be extended up to 50 feet. RS-232 port of the meter is designed in full duplex, which makes the meter more reliable and efficient in data taking.

### 6-3 RS-232 Interface Parameters Set up

In order to operate the meter via a host computer or terminal, the parameters in RS-232 interface within the meter has to match the parameters in the serial interface provided by the host or terminal.

The following procedures will guide the user to set up RS-232 interface parameters within the meter to comply RS-232 interface with the host. The default settings of the meter at factory are 9600-baud rate, non-parity, 8 data bits, and 1 stop bit (9600, n, 8, 1).

Table 6-1 indicates the factory settings and user selectable communication parameters by using RS-232 interface.

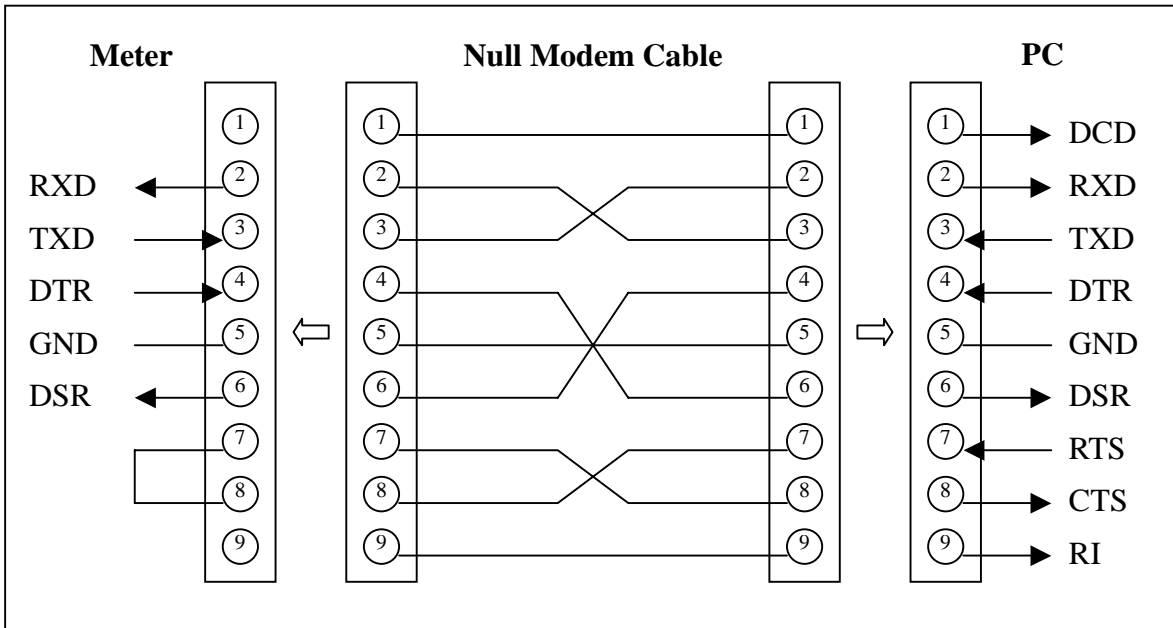

**Figure 6-1. RS-232 connecting diagrams between the meter and a PC**

- **Set up Procedures for RS-232 Parameter**

User may select computer interface and set RS-232 interface on Setup Mode. To ensure the remote interface will operate appropriately, user may need to configure the remote interface parameters. Please refer to operation procedures of Section 3-10 Entering Setup Mode.

**Table 6-1. RS-232 Interface Parameters**

Item	Parameter	Factory Setting	Selectable Parameter
1	Baud Rate	9600	9600, 4800, 2400, 1200, 600, and 300
2	Parity	None	None, Odd or Even
3	Data Bit	8	7 or 8
4	Stop Bit	1	1 or 2
5	ECHO	OFF	ON or OFF
6	Printer-Only	OFF	ON or OFF

## 6-4 Using Commands

**Note: All RS-232 commands must be entered in the upper case.**

### 6-4-1 Types of Commands

The RS-232 commands are grouped in three types:

**KEY** commands, **SET** commands, and **QUERY** commands.

- **Key Commands**

There are 16 pushbutton keys on the front panel of the meter. User may use the Key commands <K1> to <K16> for directly simulating a single keystroke by pressing on the front panel push button via RS-232 interface. User may also use other Key commands <K17> to <K20> for simulating combination keystroke functions (see complete Key commands description on Table 6-3). For example, user may use the following command sets to select the meter at Vdc 120V measurement range.

Step	Command	Equivalent Keystroke Response
1	<K1>	Select Vdc function
2	<K9>	Select one range up
3	<K9>	Select one more range up
4	<K9>	Select one more range up
5	<K9>	Select one more range up at 1000Vdc
6	<K10>	Select one range down to 120Vdc

This above operations will be more complicated and time consuming, but it would be convenient for special applications and make a virtual instrument application easier.

Please refer to Section 6-5-1 for detail information about Key Commands.

- **Set Commands**

Unlike **Key** commands, **Set** command controls the meter operations through a string of commands. For example, to set the meter at Vdc 120V range, user may only need one command string <S104>:

<S> for setting, <1> for primary display,

<0> for Vdc function, <4> for 120V range.

Please refer to Section 6-5-2 for detail information about Set Commands.

- **Query Commands**

The purpose of **Query** commands is used for requesting the meter to respond its current status. An example of a query command **<R1>** is used for requesting the meter to respond its primary display characters.

Please refer to Section 6-5-3 for detail information about Query Commands.

### 6-4-2 Command Syntax

- **Echo**

With echo ON, the meter echoes (returns) all the characters whatever it receives.

- **Terminator**

A terminator is a character sent by a host, which identifies the end of a command string. In RS-232 applications, a valid terminator consists of two-byte data:

**<CR> (Carriage Return) and <LF> (Line Feed)**

- **Prompts**

When a host sends a command string to the meter through RS-232 interface, the meter executes the command and returns one of the prompts as shown on Table 6-2.

**Table 6-2. RS-232 Return Prompts**

Prompts	Description
>	The meter is reset to power-up initialisation status.
= >	A command is executed and no errors are detected.
! >	A command error is detected.
? >	A parameter error is detected.
# >	The local key is pressed.
S >	The set up function is under executing.
@ >	No numeric reading is available.

- **Return result**

After the meter executes a query command the return of the result will be in the following format:

**<RESULT> + <CR> <LF> + <PROMPT> + <CR><LF>**

If RS-232 of the meter is under print-only mode, the meter will print out the measured data when the measurement cycle is completed. The format of printed data will be shown as one of the following:

1. <Measurement Data> + <CR> <LF>  
for only primary display mode is enabled, or
2. <Measurement Data #1>, <Measurement Data #2> + <CR> <LF>  
for both primary display and secondary display mode are enabled

## 6-5 Instructions of Command Sets

### 6-5-1 Key Commands

**Table 6-3. Descriptions for Key Commands**

Command	Equivalent Keystroke on the front panel
K1	Press <input type="button" value="Vdc"/> key
K2	Press <input type="button" value="Adc"/> key
K3	Press <input type="button" value="Vac"/> key
K4	Press <input type="button" value="Aac"/> key
K5	Press <input type="button" value="Ω"/> key
K6	Press <input type="button" value="Diode"/> key
K7	Press <input type="button" value="Hz"/> key
K8	Press <input type="button" value="AUTO"/> key
K9	Press <input type="button" value=""/> key
K10	Press <input type="button" value=""/> key
K11	Press <input type="button" value="MinMax"/> key
K12	Press <input type="button" value="Hold"/> key
K14	Press <input type="button" value="REL"/> key
K15	Press <input type="button" value="Shift"/> key
K16	Press <input type="button" value="2nd"/> key.
K17	Press <input type="button" value="Vdc"/> and <input type="button" value="Vac"/> keys simultaneously
K18	Press <input type="button" value="Adc"/> and <input type="button" value="Aac"/> keys simultaneously
K19	Press <input type="button" value="Shift"/> then <input type="button" value=""/> keys on the front panel. (Increasing the intensity of VFD display)
K20	Press <input type="button" value="Shift"/> then <input type="button" value=""/> keys on the front panel. (Decreasing the intensity of VFD display)

## 6-5-2 Set Commands

- **S1 command**

The S1 command is used to set up the measurement functions, ranges, and reading rates for the primary display in the meter.

The S1 command is followed by three parameters  $\langle f \rangle$ ,  $\langle r \rangle$ , and  $\langle x \rangle$  in order.

All characters for the  $\langle f \rangle$ ,  $\langle r \rangle$ , and  $\langle x \rangle$  parameters must be in the upper case.

For detail information of using the S1 command, see Table 6-4 and Table 6-6.

**Table 6-4. Descriptions for S1 Command**

Syntax	Description
<b>S1</b> $\langle f \rangle \langle r \rangle \langle x \rangle$	<p>In S1 command, <math>\langle f \rangle</math>, <math>\langle r \rangle</math>, and <math>\langle x \rangle</math> parameters are used to set up the primary display measurements:</p> <p><math>\langle f \rangle</math> for specifying Measurement functions, <math>\langle r \rangle</math> for specifying ranges, and <math>\langle x \rangle</math> for specifying reading rate.</p>
	<p><math>\langle f \rangle</math> is a necessary parameter for specifying the measurement functions. <math>\langle f \rangle</math> parameter is defined by a numeric value from “0” to “9” and character “A”.</p>
	<p><math>\langle r \rangle</math> is an optional parameter for specifying measurement range. <math>\langle r \rangle</math> parameter is defined by a numeric value from “0” to “7”. If <math>\langle r \rangle</math> parameter is omitted (<math>\langle x \rangle</math> parameter should be omitted, too.) The meter will be set at auto-ranging.</p>
	<p><math>\langle x \rangle</math> is an optional parameter for specifying a reading rate. It is defined by a character “S”, “M”, or “F”, in which “S” is for slow rate, “M” for medium rate, and “F” for fast rate</p> <p>If <math>\langle x \rangle</math> parameter is not specified, the meter will remain on its current reading rate without change.</p>
	<p>Table 6-6 shows all available S1 command parameters and available combinations.</p> <p><b>Example 1: “S104S”</b> (<math>\langle f \rangle</math>, <math>\langle r \rangle</math> and <math>\langle x \rangle</math> are all specified)</p> <p>Set primary display of the meter to DCV 120V with manual range and at slow reading rate.</p> <p><b>Example 2: “S142”</b> (<math>\langle x \rangle</math> is omitted)</p> <p>Set primary display to DCA 120mA with manual range, and the reading rate will not be affected.</p> <p><b>Example 3: “S17”</b> (Both <math>\langle r \rangle</math> and <math>\langle x \rangle</math> are omitted)</p> <p>Set primary display to frequency with auto ranging and the reading rate will not be affected.</p>

**Table 6-5. Descriptions for S2 Command**

Command	Description
S2<f><r><x>	<p>In S2 command, &lt;f&gt;, &lt;r&gt;, and &lt;x&gt; parameters are used to set up the secondary display measurements:</p> <p>&lt;f&gt; for specifying Measurement functions, &lt;r&gt; for specifying ranges, and &lt;x&gt; for specifying reading rate.</p>
	<p>&lt;f&gt; is a necessary parameter for specifying the measurement functions. &lt;f&gt; parameter is defined by a numeric value from “0” to “9” and character “A”.</p> <p>Because the secondary display can only display DCV, ACV, DCA, ACA, and Frequency (Hz) functions, therefore, the available parameters are “0”, “1”, “4”, “5” and “7”.</p>
	<p>&lt;r&gt; is an optional parameter for specifying measurement range. The parameter value can be from “0” to “7”. If &lt;r&gt; parameter is omitted, &lt;x&gt; parameter should be omitted, too. The meter is set to auto-ranging and will stay at the current reading rate.</p>
	<p>&lt;x&gt; is an optional parameter for specifying a reading rate. It is defined by a character “S”, “M”, or “F”, in which “S” is for slow rate, “M” for medium rate, and “F” for fast rate</p> <p>If &lt;x&gt; parameter is not specified, the meter will remain on its current reading rate without change.</p>
	<p>Table 6-6 shows all available S2 command parameters and available combinations.</p> <p><b>Example 1: “S204S”</b> (&lt;f&gt;, &lt;r&gt; and &lt;x&gt; are all specified)</p> <p>Set secondary display of the meter to DCV 120V with manual range and at slow reading rate.</p> <p><b>Example 2: “S242”</b> (&lt;x&gt; is omitted)</p> <p>Set secondary display to DCA 120mA with manual range and the reading rate will not be affected.</p> <p><b>Example 3: “S27”</b> (Both &lt;r&gt; and &lt;x&gt; are omitted)</p> <p>Set secondary display to frequency with auto-ranging and the reading rate will not be affected.</p>

**Table 6-6 S1, S2 Commands and <f>, <r>, <x> Parameters**

Parameter Function	S1	S2	<r>	<x> =		
	<f>			S (Slow)	M (Medium)	F (Fast)
Vdc	0		0	Auto range	Auto range	
			1	120mV	400mV	
			2	1.2V	4V	
			3	12V	40V	
			4	120V	400V	
			5	1000V	1000V	
Vac	1		0	Auto range	Auto range	
			1	120mV	400mV	
			2	1.2V	4V	
			3	12V	40V	
			4	120V	400V	
			5	750V	750V	
Ω/2-wire	2	N/A <sup>(1)</sup>	0	Auto range	Auto range	
Ω/4-wire	3		1	120Ω	400Ω	
			2	1.2kΩ	4kΩ	
			3	12kΩ	40kΩ	
			4	120kΩ	400kΩ	
			5	1.2MΩ	4MΩ	
			6	12MΩ	40MΩ	
7	120MΩ	300MΩ				
Adc	4		0	Auto range	Auto range	
Aac	5		1	12mA	40mA	
			2	120mA	120mA	
			3	1.2A <sup>(2)</sup>	1.2A <sup>(2)</sup>	
			4	12A	12A	
Diode	6	N/A <sup>(1)</sup>	0	Auto range	Auto range	
			1	1.2V	2.5V	
Hz	7		0	Auto range	Auto range	
			1	1200Hz	1200Hz	
			2	12kHz	12kHz	
			3	120kHz	120kHz	
			4	1MHz	1MHz	
V (ac+dc)	8	N/A <sup>(1)</sup>	0	Auto range	Auto range	
			1	120mV	400mV	
			2	1.2V	4V	
			3	12V	40V	
			4	120V	400V	
			5	750V	750V	
A (ac+dc)	9	N/A <sup>(1)</sup>	0	Auto range	Auto range	
			1	12mA	40mA	
			2	120mA	120mA	
			3	1.2A <sup>(2)</sup>	1.2A <sup>(2)</sup>	
			4	12A	12A	
Continuity (Ω/2-wire)	A	N/A <sup>(1)</sup>	0	120Ω	400Ω	
			1	120Ω	400Ω	
			2	1.2kΩ	4kΩ	
			3	12kΩ	40kΩ	
			4	120kΩ	400kΩ	
			5	1.2MΩ	4MΩ	
			6	12MΩ	40MΩ	
			7	120MΩ	300MΩ	

<sup>(1)</sup> Not Applicable  
<sup>(2)</sup> For 5492 only



**Table 6-7. Descriptions for SH Command**

Syntax	Description
SH<s><nnnnnn>	SH command is used to set high limit in counts for compare function. <s> is a sign symbol for the high limit, can be set as “+” or “-“. <nnnnnn> is a six-digit decimal number from “000000” to “199999”.

Example: “SH+102345”

Rate	Range	High limit to be
Slow	120.000 V	+102.345V
Medium	400.00V	+1023.45V
Fast *1	400.0V	+1023.4 V

Notes:

- The least setting digit is blank on the display of meter, but it still uses to compare function. To set least setting digit to “0” for fast mode as necessary.

**Table 6-8. Descriptions for SL Command**

Syntax	Description
SL<s><nnnnnn>	SL command is used to set the low limit in counts for compare (COMP) function. <s> is a sign symbol “+” or “-“. <nnnnnn> is a six-digit decimal number from “000000” to “199999”.

Example: “SL-098765”

Rate	Range	Low limit to be
Slow	120.000 V	- 98.765V
Medium	400.00V	- 987.65V
Fast *1	400.0V	- 987.6 V

Notes:

- The least setting digit is blank on the display of meter, but it still uses to compare function. To set least setting digit to “0” for fast mode as necessary.

**Table 6-9. Descriptions for SR Command**

Syntax	Description
SR<s><nnnnnn>	SR command is used to set the relative base for relative function. <s> is a sign symbol “+” or “-”. <nnnnnn> is a six-digit number from “000000” to “199999”.

Example: “SR+001000”

Rate	Range	Relative base modifier to be
Slow	120.000 V	+1.000V
Medium	400.00V	+10.00V
Fast *1	400.0V	+10.0 V

Notes:

The least setting digit is blank on the display of meter, but it still uses to relative base. To set least setting digit to “0” for fast mode as necessary.

**Table 6-10. Descriptions for SO Command**

Syntax	Description																																																
SO<nn>	SO<nn> command is used to select the reference impedance for dBm calculation. <nn> is a two-digit decimal numeric number from “00” to “20”, representing 21 different types of reference impedance.  Example: Command string “SO15” to set reference impedance at 600Ω.																																																
	<table border="1"> <thead> <tr> <th>nn</th> <th>Impedance</th> <th>nn</th> <th>Impedance</th> <th>nn</th> <th>Impedance</th> </tr> </thead> <tbody> <tr> <td>00</td> <td>2Ω</td> <td>07</td> <td>110Ω</td> <td>14</td> <td>500Ω</td> </tr> <tr> <td>01</td> <td>4Ω</td> <td>08</td> <td>124Ω</td> <td>15</td> <td>600Ω</td> </tr> <tr> <td>02</td> <td>8Ω</td> <td>09</td> <td>125Ω</td> <td>16</td> <td>800Ω</td> </tr> <tr> <td>03</td> <td>16Ω</td> <td>10</td> <td>135Ω</td> <td>17</td> <td>900Ω</td> </tr> <tr> <td>04</td> <td>50Ω</td> <td>11</td> <td>150Ω</td> <td>18</td> <td>1000Ω</td> </tr> <tr> <td>05</td> <td>75Ω</td> <td>12</td> <td>250Ω</td> <td>19</td> <td>1200Ω</td> </tr> <tr> <td>06</td> <td>93Ω</td> <td>13</td> <td>300Ω</td> <td>20</td> <td>8000Ω</td> </tr> </tbody> </table>	nn	Impedance	nn	Impedance	nn	Impedance	00	2Ω	07	110Ω	14	500Ω	01	4Ω	08	124Ω	15	600Ω	02	8Ω	09	125Ω	16	800Ω	03	16Ω	10	135Ω	17	900Ω	04	50Ω	11	150Ω	18	1000Ω	05	75Ω	12	250Ω	19	1200Ω	06	93Ω	13	300Ω	20	8000Ω
nn	Impedance	nn	Impedance	nn	Impedance																																												
00	2Ω	07	110Ω	14	500Ω																																												
01	4Ω	08	124Ω	15	600Ω																																												
02	8Ω	09	125Ω	16	800Ω																																												
03	16Ω	10	135Ω	17	900Ω																																												
04	50Ω	11	150Ω	18	1000Ω																																												
05	75Ω	12	250Ω	19	1200Ω																																												
06	93Ω	13	300Ω	20	8000Ω																																												

### 6-5-3 Query Commands

- **R0 command**

**R0** command is used for requesting the meter to return its current status.

The meter will then respond the following 10-digit character string to the host after receiving the R0 command:  $\langle h_1h_2 \rangle \langle g_1g_2 \rangle \langle v \rangle \langle x \rangle \langle f_1 \rangle \langle r_1 \rangle \langle f_2 \rangle \langle r_2 \rangle$

For detail information of using R0 command, please refer to Table 6-11 and Table 6-12.

**Table 6-11. Descriptions for R0 Command and Response**

Syntax	Response Description				
R0	<p>R0 command is used to read the status of the meter.</p> <p>The meter will respond the following character string:</p> $\langle h_1h_2 \rangle \langle g_1g_2 \rangle \langle v \rangle \langle x \rangle \langle f_1 \rangle \langle r_1 \rangle \langle f_2 \rangle \langle r_2 \rangle$				
Response	Description				
$\langle h_1h_2 \rangle$	<p><math>\langle h_1h_2 \rangle</math> is a two-digit hex number; each digit contains 4-bit binary codes (Bit 7-4 and Bit 3-0 respectively) to represent eight types of status about the meter.</p> <p><math>\langle h_1 \rangle</math> and <math>\langle h_2 \rangle</math> representations are described as follows.</p> <p><math>\langle h_1 \rangle</math> indicates the results of compare (COMP) function and whether the meter is operating in a dual display mode;</p> <p><math>\langle h_2 \rangle</math> represents the ON/OFF status for other four types of arithmetic function.</p> <p>Example: If <math>\langle h_1h_2 \rangle</math> contains a character string "A8", convert it to an 8-bit binary format "10101000" that means the meter is in Dual display mode, compare function is ON, and the result of compare is Pass.</p>				
	$\langle h_1h_2 \rangle$	Bit	Status	0	1
	$\langle h_1 \rangle$	7	Compare mode	off	on
		6	Relative mode	off	on
		5	dB mode	off	on
		4	dBm mode	off	on
	$\langle h_2 \rangle$	3	Display Mode	Single	Dual
		2	Compare Result	x	Hi
		1		x	Pass
		0		x	Lo

**Table 6-11. Descriptions for R0 Command and Response (cont'd)**

Response	Description				
<b>&lt;g<sub>1</sub>g<sub>2</sub>&gt;</b>	<p><b>&lt;g<sub>1</sub>g<sub>2</sub>&gt;</b> is a two-digit hex number; each digit contains 4-bit binary codes (Bit 7-4 and Bit 3-0) respectively to represent eight types of status about the meter.</p> <p><b>&lt;g<sub>1</sub>&gt;</b> indicates the status for four types of meter operation;</p> <p><b>&lt;g<sub>2</sub>&gt;</b> indicates the ON/OFF status for other four types of meter operation,</p> <p>Example: If <b>&lt;h<sub>1</sub>h<sub>2</sub>&gt;</b> contains a character string “18”, convert it to an 8-bit binary code “00011000” that means the meter is under Auto-ranging for Primary Display (1<sup>st</sup> Auto-Ranging) and the reading is on hold.</p>				
	<b>&lt;g<sub>1</sub>g<sub>2</sub>&gt;</b>	<b>Bit</b>	<b>Status</b>	<b>0</b>	<b>1</b>
	<b>&lt;g<sub>1</sub>&gt;</b>	7	CAL Mode	off	on
		6	2nd Function	off	on
		5	Shift Key	off	on
		4	Hold Reading	off	on
	<b>&lt;g<sub>2</sub>&gt;</b>	3	1 <sup>st</sup> Auto-Ranging	off	on
		2	2 <sup>nd</sup> Auto-Ranging	off	on
1		MIN Recording	off	on	
0		MAX Recording	off	on	
<b>&lt;v&gt;</b>	<p><b>&lt;v&gt;</b> is a single numeric numbers “0”, “1”, “2”, or “3” used for representing the intensity level of VFD display on the meter.</p>				
	<b>&lt;v&gt;</b>	<b>0</b>	<b>1</b>	<b>2</b>	<b>3</b>
	<b>Intensity Level</b>	<b>50%</b>	<b>60%</b>	<b>75%</b>	<b>100%</b>
<b>&lt;x&gt;</b>	<p><b>&lt;x&gt;</b> indicates the status of reading rate of the meter. This character may contain one of three different characters “S,M, or F”, in which “S” represents for slow rate, “M” for medium rate, and “F” for fast rate.</p>				
<b>&lt;f<sub>1</sub>&gt;&lt;r<sub>1</sub>&gt;</b> and <b>&lt;f<sub>2</sub>&gt;&lt;r<sub>2</sub>&gt;</b>	<p><b>&lt;f<sub>1</sub>&gt;</b> indicates the measurement function in primary display. It contains numeric value from “0” to “9” and character “A”.</p> <p><b>&lt;r<sub>1</sub>&gt;</b> is primary display measurement range The value is from “1” to “7”. Please refer to Table 6-11 for an available value.</p> <p><b>&lt;f<sub>2</sub>&gt;</b> and <b>&lt;r<sub>2</sub>&gt;</b> are similar to <b>&lt;f<sub>1</sub>&gt;</b> and <b>&lt;r<sub>1</sub>&gt;</b> but representing the secondary display status instead. If the meter is operated under single display mode, <b>&lt;f<sub>2</sub>&gt;</b> and <b>&lt;r<sub>2</sub>&gt;</b> will not be returned.</p> <p>For detail information of interpreting the <b>&lt;f<sub>1</sub>&gt;&lt;r<sub>1</sub>&gt;</b> and <b>&lt;f<sub>2</sub>&gt;&lt;r<sub>2</sub>&gt;</b>, please refer to Table 6-12.</p>				

**Table 6-12 <math>\langle f\_1 \rangle \langle r\_1 \rangle</math> and <math>\langle f\_2 \rangle \langle r\_2 \rangle</math> Response for R0 Command**

Function	<math>\langle f_1 \rangle</math>=	<math>\langle f_2 \rangle</math>=	<math>\langle r_1 \rangle</math> or <math>\langle r_2 \rangle</math>=	Range		
				Sow Rate	Med. Rate	Fast Rate
Vdc	0		1 2 3 4 5	120mV 1.2V 12V 120V 1000V	400mV 4V 40V 400V 1000V	
Vac	1		1 2 3 4 5	120mV 1.2V 12V 120V 750V	400mV 4V 40V 400V 750V	
$\Omega$ /2-wire	2	N/A <sup>(1)</sup>	1 2 3 4	120 $\Omega$ 1.2k $\Omega$ 12k $\Omega$ 120k $\Omega$	400 $\Omega$ 4k $\Omega$ 40k $\Omega$ 400k $\Omega$	
$\Omega$ /4-wire	3		5 6 7	1.2M $\Omega$ 12M $\Omega$ 120M $\Omega$	4M $\Omega$ 40M $\Omega$ 300M $\Omega$	
Adc	4		1 2	12mA 120mA	40mA 120mA	
Aac	5		3 4	1.2A <sup>(2)</sup> 12A	1.2A <sup>(2)</sup> 12A	
Diode	6		N/A <sup>(1)</sup>	1	1.2V	2.5V
Hz	7			1 2 3 4	1200Hz 12kHz 120kHz 1MHz	1200Hz 12kHz 120kHz 1MHz
V (ac+dc)	8		N/A <sup>(1)</sup>	1 2 3 4 5	120mV 1.2V 12V 120V 750V	400mV 4V 40V 400V 750V
A (ac+dc)	9	N/A <sup>(1)</sup>	1 2 3 4	12mA 120mA 1.2A <sup>(2)</sup> 12A	40mA 120mA 1.2A <sup>(2)</sup> 12A	
Continuity ( $\Omega$ /2-wire)	A	N/A <sup>(1)</sup>	1 2 3 4 5 6 7	120 $\Omega$ 1.2k $\Omega$ 12k $\Omega$ 120k $\Omega$ 1.2M $\Omega$ 12M $\Omega$ 120M $\Omega$	400 $\Omega$ 4k $\Omega$ 40k $\Omega$ 400k $\Omega$ 4M $\Omega$ 40M $\Omega$ 300M $\Omega$	

<sup>(1)</sup> Not Applicable

<sup>(2)</sup> For 5492 only

- **R1 command**

After executing R1 command, the meter will return the current readings in its primary display.

For example, a returned character string “+110.234E+0” represents the primary display reading is “+110.234” when the meter executes R1 command.

- **R2 command**

After executing R2 command, the meter will return the current readings in its secondary display.

For example, a returned character string “-3.0000E+0” representing the primary display reading is “-3.0000” when the meter executes R2 command.

If the meter is operating under primary display mode, it will return a character “@>”.

- **RALL command**

**RALL** command is a combination of **R0**, **R1** and **R2**. The meter will return the meter status, primary display readings, and secondary display readings in sequence.

For information regarding **R0**, **R1**, and **R2**, please see Table 6-11 and Table 6-12.

- **RST command**

**RST** command can reset the meter to its power up initialization status without shutting down the line power. It is useful to refresh the meter in warm-start.

- **RV command**

**RV** command is used to read the firmware version and model type of the meter (5492 or 5491).

The syntax of returned character string is specified by *<Vx.xx>*, *<m>*. It contains two parts of character string separated by a comma (,) in between.

*<Vx.xx>* represents the current firmware version, and

*<m>* represents the model name:

*<m>* =6 for 5492,

*<m>* =5 for 5491.

For example, a returned character string “V1.00, 5” represents 5491 installed with firmware version “V.1.00”.

## 6-6 Remote Program Examples using RS-232 interface

### • Example Using Quick BASIC

```
DECLARE FUNCTION TKDATA! ()
DECLARE SUB TKECHO ()
'DEMO.BAS          - This program set the meter to record Vdc measurement on the primary display
'                  - and Vac measurement on the secondary display.
'                  - The results will also be printed on the computer screen.
'                  - Runs on MS-DOS QBasic 1.1,Microsoft Quick BASIC 4.5
'Notice:          - When use this program, the RS-232 of the meter should be set the following
'                  - parameters.
'                  - 1. BAUD 9600
'                  - 2. DATA 8 BIT
'                  - 3. PRITY NONE
'                  - 4. STOP 1BIT
'                  - 5. ECHO OFF
'                  - 6. PRINT OFF
'                  - This program uses COM1 to communicate with the meter.
'                  - Version 1.2 (Modified By CC Tung. May31, 2002)

OPEN "COM1:9600,N,8,1,CD,CS,DS" FOR RANDOM AS #1
'Open COM1 for communication. 9600 baud, no parity, 8 data bits, 1 stop bit, ignore Data Carrier Detect
(DCD),
'Clear To Send (CTS), and Data Set Ready (DSR) signals

CMD$ = "RST"      'Reset the meter.
PRINT #1, CMD$   'Send command to the meter.

TKECHO           'Waiting "=>" and checking if the command is executed successfully.
TKECHO           'Waiting "*>" to make sure the meter is in power on initial state.

CMD$ = "S101"     'Set primary display to Vdc function, auto-ranging mode.
PRINT #1, CMD$   'Send command to the meter.

TKECHO           'Waiting "=>" and checking if the command is executed successfully.

CMD$ = "S211"     'Set secondary display to Vac function, auto-ranging mode.
PRINT #1, CMD$   'Send command to the meter.

TKECHO           'Waiting "=>" and checking if the command is executed successfully.

SLEEP 3          'Wait for 3 sec.

CMD$ = "R1"      'Read primary display reading
PRINT #1, CMD$   'Send command to the meter.

PRINT TKDATA; "V,"; 'Print the value on computer screen.
TKECHO           'Waiting "=>" and checking if the command is executed successfully.

CMD$ = "R2"      'Read secondary display reading
PRINT #1, CMD$   'Send command to the meter.

PRINT TKDATA; "V" 'Print the value on computer screen.
TKECHO           'Waiting "=>" and checking if the command is executed successfully.
CLOSE #1        'Release COM1.
END             'End of the program.
```

<b>FUNCTION TKDATA</b>	
<b>LINE INPUT #1, RDS</b>	'Read COM1.
<b>TKDATA = VAL(RDS)</b>	'Convert a string to numeric value and return 'the value to main program.
<b>END FUNCTION</b>	
<b>SUB TKECHO</b>	
<b>LINE INPUT #1, PROMPT\$</b>	'Get a string from COM1. Check if
	'PROMPT\$=<LF>+"=>"
<b>PROMPT\$ = RIGHTS(PROMPT\$, 2)</b>	'Discard <LF>
<b>IF PROMPT\$ &lt;&gt; "=&gt;" AND PROMPT\$ &lt;&gt; "*&gt;" THEN</b>	'If not successful then ...
<b>LOCATE 24, 1</b>	'Set the printing position to Line 24, column 1
<b>PRINT "COMMAND EXECUTE ERROR !"</b>	'Print error message.
<b>END IF</b>	
<b>END SUB</b>	



- **Example Program Using Turbo C**

```

#include <stdio.h>
#include <conio.h>
#define COM1 0x3f8
#define COM2 0x2f8
#define COM3 0x3e8
#define COM4 0x2e8
#define RS232 COM1

void init_rs232(void);
void send(char);
char read(void);
void send_buffer(char*);
void tkecho(char*);
char* tkdata(char*);
int scan_key(void);
int err;

void main(void)
{
char buffer[35];

clrscr(); //Clear screen
init_rs232(); //Initial RS232 interface
printf("Initial RS232....\n"); //Print "Initial RS232...." on screen

send_buffer("RST\015\n"); //Send "RST" to meter.
tkecho("=>\015\n"); //Waiting "=>" and checking if the command is executed successfully.

tkecho("*>\015\n") //Waiting ">" to make sure the meter is in power on initial state.
send_buffer("S101\015\n"); //Send "S101" to meter.

tkecho("=>\015\n"); //Waiting "=>" and checking if the command is executed successfully.

send_buffer("S211\015\n") //Send "S101" to meter..

tkecho("=>\015\n"); //Waiting "=>" and checking if the command is executed successfully.

sleep(3); // Wait for 3 seconds.

send_buffer("R1\015\n"); //Send "R1" to meter. Read primary display reading.

printf("%s",tkdata(buffer)); //Print primary display reading on computer screen.
tkecho("=>\015\n"); //Waiting "=>" and checking if the command is executed successfully.

send_buffer("R2\015\n"); //Send "R2" to meter. Read primary reading.

printf ("%s",tkdata(buffer)); //Print secondary display reading on computer screen.

tkecho("=>\015\n"); //Waiting "=>" and checking if the command is executed successfully.
printf("Press any key to continue");

getch(); //Wait for a key.
}

```

```

void init_rs232(void)
{
    outportb(RS232+3,0x80);           //Enable DLAB
    outportb(RS232+1,0x00);         //600bps-115200bps
    outportb(RS232,0x0c);          //9600bps
    outportb(RS232+3,0x03);         //LCR (8N1)
    outportb(RS232+4,0x03);         //MCR
    outportb(RS232+1,0x00);         //IER
}

void send_buffer(char *buffer           //Send a string to RS-232
{
    unsigned int i;
        for (i=0;i<=20;i++)
            {
                send(buffer[i]);
                putchar(buffer[i]);
                if (buffer[i]=='\n')
                    break;
            }
}

void tkecho(char *buffer)               //Wait for a specific string
{
    unsigned int i=0;
        while (1)
            {
                if(buffer[i]==read())
                    {
                        putchar(buffer[i]);
                        if (buffer[i]=='\n')
                            break;
                    }
                i++;
            }
}

char* tkdata(char* buffer)              //Get a string from RS232 and return the decimal point position.
{
    unsigned int i=0;

        while (1)
            {
                buffer[i]=read();

                if (((i>0)&&(buffer[i]=='\n'))||((i>30)))
                    break;

                if((buffer[i]>33)&&(buffer[i]<126))
                    i++;
            }

    buffer[++i]=0;
    return buffer;
}

void send(char p)
{
    unsigned int retry=0;

```

```
err=1;
    while(++retry<10000)
        if(0x20&inportb(RS232+5))
            {
                outportb(RS232,p);
                err=0;
                break;
            }
}
```

```
char read(void)
{
    unsigned int retry=0;
    err=1;
    while(++retry<30000)
        if(0x01&inportb(RS232+5))
            {
                err=0;
                break;
            }
    return(inportb(RS232));
}
```

(This page is subject to be blank)

# GPIB Remote Operation (Option)

### 7-1 Introduction

This section describes how to operate the meter via GPIB interface. It also explains the detail information of all IEEE 488.2 command sets and Standard Commands for Programmable Instruments (SCPI) used in the meter. The remote control operation enables the user either to manually operate the meter via a terminal or executes a host computer program automatically.

### 7-2 Description of the GPIB

The GPIB is a bus structure that links the meter to desktop computers and others GPIB controlled instruments to form an automated measurement system. GPIB can connect up to 15 devices on one contiguous bus, star or linear bus network. Total transmission path length is 2 meters times' number of devices, whichever is less, with a maximum of 3 meters separating any two devices. Asynchronous 8 bits parallel data transfer using a 3-wire handshake.

One megabyte per second (maximum) over limited distances; actual data rate depends upon the capability of the slowest device involved in the transmission.

### 7-3 GPIB Interface Parameters Set up

With the optional GPIB (IEEE-488) interface installed, the meter is fully programmable for used on the IEEE-488.1 interface bus (1978). The meter is also designed to comply with the supplemental standard IEEE-488.2 (1987).

In order to operate the meter via a host computer or terminal, the parameters in GPIB interface within the meter has to match the parameters in the bus interface provided by the host or terminal.

The following procedures will guide the user to set up GPIB interface parameters within the meter to comply GPIB interface with the host. The default settings of the meter at factory are address 8 and talk off.

Table 7-1 indicates the GPIB interface factory settings and user selectable communication parameters.

**Table 7-1. GPIB Interface Parameters**

Item	Parameter	Factory Setting	Selectable Parameter
1	Address	8	0 to 30
2	Talk	OFF	ON or OFF

## 7-4 Commands Summary

**Note: All commands must be entered in the upper case.**

### 7-4-1 Overview of Command Type and Formats

There are two types of the meter programming commands: IEEE 488.2 common commands and Standard Commands for Programmable Instruments ( SCPI ). The SCPI commands used in the meter are in conformance with the SCPI standard Version 1993.0.

- **Common Command Format**

The IEEE 488.2 standard defines the common commands as commands that perform functions like reset, self-test and status byte query. Common commands always come with the asterisk "\*" character, and may include parameters. Some examples of Common commands like: \*IDN? , \*RST , \*CLS , \*SRE?.

- **SCPI Command Format and Query Format**

The SCPI commands control instrument functions. A subsystem command has a hierarchical structure that usually consists of a top level (or root) keyword, one or more lower level keywords, and parameters. The following example shows a command and its associated query:

A. **CONF**igure:VOLTage:DC 0.12 ; Set the primary display to the DC voltage measurement function , and select the 120mV range.

B. **CONF**igure:RANGe? ; Return the range of the primary display measurement.

**CONF**igure is a root level keyword with the second level keyword, **VOLT**age, and **0.12** is the command parameter. The query command ends with a question mark "?".

Note : SCPI stems from IEEE488.1 and IEEE 488.2. Although the IEEE 488.2 standard addressed some instrument measurements, it principally dealt with common commands and syntax or data formats. Please refer to the IEEE488.2 and SCPI reference manual for more information.

## 7-4-2 Response Message Data Types

Response messages are data from the meter to a computer in response to a query. A query is a command followed by a question mark. Table 7-2 contains explanations of data types.

**Table 7-2. Response Message Data Types**

Data Type	Explanations	Examples
<NR1>	An integer	+100000, -10000, 123, -100
<NR2>	This numeric representation has an explicit radix point	+13.23455, -.00002, 3.45678
<NR3>	This representation has an explicit radix point and an exponent.	+1.2E+2, +0.1E+0, -0.12E-3, 9E+9
<numeric value>	Accepts <NR1>, <NR2> and <NR3> data types.	
<NRf>	Flexible numeric representation (only positive integers).	100, 255, 16
<Boolean>	A single ASCII-encoded byte, is return for the settings query.	0 or 1, OFF or ON
<literal>	ASCII-encoded bytes corresponding to the short form of the literal used as the command parameter.	SLOW, MID, IMM, BUS, DC, AC

### 7-4-3 Status Reporting

The meter status registers conform to the SCPI and IEEE-488.2 standards.

- **Status Byte Register ( STB)**

Bit7	Bit6	Bit5	Bit4	Bit3	Bit2	Bit1	Bit0
OPER	RQS/ MSS	ESB	MAV	QUES	ERRQ	0	0

Bit 0 - 1 are not used.

Bit 2 ( ERRQ ) - This bit indicates whether or not the Error Queue is empty.

It ' s set to 1 when the Error Queue is not empty.

Bit 3 ( QUES ) - Summarizes the Questionable Data/Signal Status Event

Register. It ' s set to 1 when one or more enable Questionable Event Register are set to TRUE.

Bit 4 ( MAV ) - Summarizes the Output Queue. It ' s set to 1 when the Output

Queue is not empty.

Bit 5 ( ESB ) - Summarizes the Standard Event Status Register ( ESR ).

It ' s set to 1 when one or more enable ESR bits are 1.

Bit 6 ( RQS MSS ) - Requesting service and Master summary status. When RQS bit is set to 1, the meter asserts the SRQ control line on the IEEE-488 interface. You can do a serial poll to read the Status Byte Register. When \*STB? is used to read the Status Byte Register, the MSS bit indicates the Master summary status.

Bit 7 ( OPER ) - Summarizes the Operation Status Event Register. It ' s set to 1, when one or more enable Operation Status Event Register are set to TRUE.

Note : 1. The Status Byte Register can be read with either a serial poll or the \*STB? query.

2. The register is cleared at power up.



- **Service Request Enable Register ( SRE )**

The Service Request Enable Register that enables or disables (i.e., masks ) corresponding summary messages in the Status Byte Register. The SRE is cleared at power up. Refer to "Status Byte Register" for the bit functions.

Use \*SRE to write to this register and \*SRE? to read this register.

- **Standard Event Status Register ( ESR)**

Bit7	Bit6	Bit5	Bit4	Bit3	Bit2	Bit1	Bit0
PON	0	CME	EXE	DDE	QYE	0	OPC

Bit 0 (OPC) - Operation complete. This bit is generated in response to the \*OPC command and indicates that the interface is ready to accept another message.

Bit 1 is not used. (Always set to 0 )

Bit 2 (QYE) - Query Error. Attempt has been made to read the Output Queue when no output is present or pending. Or, both input and output buffer are full.

Bit 3 (DDE) - Device-Dependent Error. Incorrect input during calibration, or RS-232 input buffer overflow.

Bit 4 (EXE) - Execution Error. Parameter is wrong or unknown.

Bit 5 (CME) - Command Error. Command is wrong or unknown.

Bit 6 is not used. (Always set to 0)

Bit 7 (PON) - Power On. Power has been cycled off and on since the last time the ESR was read.

Note: 1. The Standard Event Status Register can be read by the \*ESR? query.

2. The register is cleared at power up or use \*ESR? and \*CLS commands.

- **Standard Event Status Enable Register ( ESE )**

The Standard Event Status Enable Register is a mask register that allows the host to enable or disable (mask) each bit in ESR. When a bit in the ESE is 1, the corresponding bit in the ESR is enable. When any enabled bit in the ESR changes from 0 to 1, the ESB summary bit (bit 5) of the STB register also goes to 1.

Use \*ESE to write to this register and \*ESE? to read this register.

- **Operation Event Register**

The Operation Event Register assigns specified event to specific Operation Event Status Register bits.

Operation Status Register:

Bit 9 to 15	Bit 8	Bit 7	Bit 6 to 5	Bit 4	Bit 3 to 0
0	2ND	Compare	0	Measuring	0

Bit 0 - 3 are not used.

Bit 4 (Measuring) is set as 1 when the meter is at the end of a measurement cycle.

Bit 5 - 6 are not used.

Bit 7 (Compare) is set as 1 when the meter is operating in the compare mode.

Bit 8 (2ND) is set as 1 when the meter is operating in the dual display mode.

Bit 9 -15 are not used.

Note: Use \*CLS to clear event registers.

## 7-5 Instructions of Command Sets

### 7-5-1 IEEE 488.2 Common Commands

#### **\*CLS**

Description : Clear the Standard Event Status Register, Operation Event Status Register, Questionable Data Event Status Register and the Error Queue.

#### **\*ESE <NRf>**

Description : Set the Standard Event Status Enable Register.

Parameter : <NRf> (0 to 255).

Example : \*ESE 140; Enable bits 2 (QYE), 3 (DDE), and 7 (PON), and disable all the other bits.

#### **\*ESE?**

Description : Query the Standard Event Status Enable Register.

Response : (Integer) Decimal equivalent of the register byte. Range is 0 to 255.

#### **\*ESR?**

Description : Query the Standard Event Status Enable Register and clears the register.

Response : (Integer) Decimal equivalent of the register byte.

Example : \*ESR? ; Return: `32` if bit 5 (CME) is set (1) and the rest of the bits are reset (0).

#### **\*IDN?**

Description : Query the Meter identification.

Response : Return the following information : Model, and Firmware version.

#### **\*OPC**

Description : Set the Operation Complete bit in the Standard Event Status Register when all pending device operations are complete.

### **\*OPC?**

Description : This command pauses program execution until all operations are completed.

Response : Return a '1' after all pending operations are complete.

### **\*RST**

Description : Place the meter in its power-on-reset state. This command does not affect:

1. the Service Register Enable or the Standard Event Status Enable.
2. the Output Queue and interface parameter.

### **\*SRE <NRf>**

Description : Set the Service Request Enable Register bits.

Parameter : <NRf> ( 0 to 255 ). The value of bit 6 and unused bits are ignored when set the register.

Example : \*SRE 56 ; Enable bits 3 (QUES), 4 (MAV), and 5 (ESB) in the Service Request Enable register.

### **\*SRE?**

Description : Query the Service Request Enable Query Register.

Response : (Integer) Decimal equivalent of the register byte. Return value is 0 to 252.

### **\*STB?**

Description : Query the Status Byte Register.

Response : (Integer) Decimal equivalent of the register byte.

Example : \*STB? ; Return: '96' if bit 4 (MAV) and 6 (MSS) are set (1) and the rest of bits are reset (0).

### **\*WAI**

Description : Command required by IEEE 488.2 standard. Non-operational in the meter.

## 7-5-2 SCPI Commands

This subsection describes the SCPI subsystem commands for the meter.

**Table 7-3. Some SCPI Symbol Conventions**

Text Symbol	Meaning
[ ]	Option; can be omitted
	Exclusive OR
< >	Defined element
( )	Comment
?	Question mark
:	SCPI command start
;	Combinations of set commands

- **ABORT** – This command has no action on the meter (SCPI approved).

- **INITiate Subsystem :**

**INITiate[:IMMediate]**

Description : This command is defined in the SCPI standard. It will initialize the meter but don't affect the settings in the setup menu.

**INITiate[:IMMediate]:CONTinuous <Boolean>**

Description : Set the meter at free run or data hold mode.

Parameter : <Boolean> ( On, 1; off, 0 )

Example : INIT:CONT OFF or INIT:CONT 0 ; Set the meter at data hold mode.

**INITiate[:IMMediate]:CONTinuous?**

Description : Query the meter at which operation mode.

Response : 0 (data hold mode) or 1 (free run mode ).

- **CONFigure Subsystem :**

**CONFigure[:SCALar]:DISPlay:RATE < SLOW | MED | FAST >**

Description : Set the measurement rate type.

Parameter : SLOW - Select the slow measurement rate.

MED - Select the medium measurement rate.

FAST - Select the fast measurement rate.

**CONFigure[:SCALar]:DISPlay:RATE?**

Description : Return the measurement rate type.

## CONFigure

**[ :SCALar ]**

**:VOLTage**

**:DC** [**<numeric value>**] [ [ ,@1 ] | ,@2 ]

**:AC** [**<numeric value>**] [ [ ,@1 ] | ,@2 ]

**:ACDC** [**<numeric value>**] [ ,@1 ]

**:DCAC** [**<numeric value>**] [ ,@1 ]

Description : Set the primary and secondary display to voltage measurement function for the DCV, ACV or AC+DC mode. The <numeric value> parameter is used to configure the measurement range. [ [ @1 ] | ,@2 ] has the same syntax as SCPI <channel\_list> syntax. Use @1 to select the primary display function, and @2 to select the secondary display function.

Parameter : <numeric value> ; For volts range : 0.12, 0.4, 1.2, 4, 12, 40, 120, 400, 750, 1000 V.

[ [ ,@1 ] | ,@2 ] ; For the primary display and secondary display setting.

Example : CONF:VOLT:DC ; Set the primary display to DC volts .

CONF:VOLT:AC ,@2 ; Set the secondary display to AC volts .

CONF:VOLT:ACDC 0.12,@1 ; Set the primary display to AC+DC volts 120mV range .

## CONFigure

**[ :SCALar ]**

**:CURRent**

**:DC** [**<numeric value>**] [ [ ,@1 ] | ,@2 ]

**:AC** [**<numeric value>**] [ [ ,@1 ] | ,@2 ]

**:ACDC** [**<numeric value>**] [ ,@1 ]

**:DCAC** [**<numeric value>**] [ ,@1 ]

Description : Set the primary and secondary display to current measurement function for the DCA, ACA or AC+DC mode. The <numeric value> parameter is used to configure the measurement range. [ [ @1 ] | ,@2 ] has the same syntax as SCPI <channel\_list> syntax. Use @1 to select the primary display function, and @2 to select the secondary display function.

Parameter : <numeric value> ; For current range : 0.012, 0.04, 0.12, 1.2, 12 A.

[ [ ,@1 ] | ,@2 ] ; For the primary and secondary display setting.

Example : CONF:CURR:DC ;Set the primary display to DC current.

CONF:CURR:AC 0.12,@2 ;Set the secondary display to AC current 120mA range.

CONF:CURR:ACDC ,@1 ;Set the primary display to AC+DC current.

## CONFigure[:SCALar]:DIOCTest

Description : Set the primary display to diode with continuity test.

### **CONFigure[:SCALar]:FREQuency [<numeric value>] [ [ ,@1 ] | ,@2 ]**

Description : Set the primary and secondary display to frequency measurement function.

The <numeric value> parameter is used to configure the measurement range.

[ [ @1 ] | ,@2 ] has the same syntax as SCPI <channel\_list> syntax. Use @1 to select the primary display function, and @2 to select the secondary display function.

Parameter : <numeric value> ;For frequency range : 1200, 1.2E+4, 1.2E+5, 1E+6 Hz.  
[ [ ,@1 ] | ,@2 ] ;For the primary and secondary display setting.

Example : CONF:FREQ 1.2E+4 ;Set the primary display to frequency 12KHz range.

CONF:FREQ 1200 ;Set the secondary display to frequency 1200Hz

range.

### **CONFigure[:SCALar]:RESistance**

**[:2W] [ <numeric value> ]**

**:4W [ <numeric value> ]**

Description : Set the primary display to 2-wire or 4-wire resistance measurement function.

The <numeric value> parameter is used to configure the measurement range.

Parameter : <numeric value> ; For resistance range : 120, 400, 1200, 4000, 1.2E+4, 4E+4, 1.2E+5, 4E+5, 1.2E+6, 4E+6, 1.2E+7, 4E+7, 1.2E+8, 3E+8

Example : CONF:RES 1.2E+4 ; Set the primary display to resistance 12kΩ range.

### **CONFigure]**

**[:SCALar]**

**:FUNCTION? [ [ ,@1 ] | ,@2 ]**

Description : Return the measurement function. Use @1 to select the primary display function, and @2 to select the secondary display function.

Response : <literal> format ; Return the type string :

1. DCV ( DC voltage function )
2. ACV ( AC voltage function )
3. AC+DCV ( AC+DC volts coupling mode )
4. DCA ( DC current function )
5. ACA ( AC current function )
6. AC+DCA ( AC+DC volts coupling mode )
7. Hz ( Frequency function )
8. RES2W ( Resistance 2-wire function )
9. RES4W ( Resistance 4-wire function )
10. DIOC ( Diode with Continuity test )
11. NONE ( No function, only for secondary display )

### **CONFigure[:SCALar]:OFFDual**

Description : Turn off the secondary display.

### **CONFigure[:SCALar]:OFFRecord**

Description : Exit the dynamic recording mode ( MAX / MIN ).

### **CONFigure[:SCALar]:RANGe:AUTO <Boolean> [ [,@1] | ,@2 ]**

Description : Enable or disable the auto range mode.

Parameter : <Boolean> ( On,1; off,0 )

### **CONFigure[:SCALar]:RANGe:AUTO? [ [,@1] | ,@2 ]**

Description : This queries return the auto range status.

Response : 1 ( enable ) or 0 (disable ).

### **CONFigure[:SCALar]:RANGe:DIRection < UP | DOWN > [ [,@1] | ,@2 ]**

Description : Change measurement range, increases it by one step.

Parameter : < UP >, increases it by one step ; < DOWN >, decreases it by one step.

### **CONFigure]**

#### **[:SCALar]**

#### **:RANGe? [ [,@1] | ,@2 ]**

Description : Return the measurement range. Use @1 to select the primary display ,and @2 to select the secondary display.

Response : Return the range value as Table 7-4.

Example : CONF:RANG? ; Query the primary display measurement range.

CONF:RANG? ,@2 ; Query the secondary display measurement range.



**Table 7-4. Return values of measurement range**

<b>Function</b>	<b>Slow Rate</b>	<b>Return Value</b>	<b>Medium / Fast Rate</b>	<b>Return Value</b>
DC Voltage	120mV	0.12	400mV	0.4
	1.2V	1.2	4V	4
	12V	12	40V	40
	120V	120	400V	400
	1000V	1000	1000V	1000
AC Voltage	120mV	0.12	400mV	0.4
	1.2V	1.2	4V	4
	12V	12	40V	40
	120V	120	400V	400
	750V	750	750V	750
DC/AC Current	12mA	0.012	40mA	0.04
	120mA	0.12	120mA	0.12
	1200mA	1.2	1200mA	1.2
	12A	12	12A	12
Resistance	120	120	400	400
	1.2K	1200	4K	4000
	12K	1.2E+4	40K	4E+4
	120K	1.2E+5	400K	4E+5
	1.2M	1.2E+6	4M	4E+6
	12M	1.2E+7	40M	4E+7
	120M	1.2E+8	300M	3E+8
Frequency	1200Hz	1200	1200Hz	1200
	12KHz	1.2E+4	12KHz	1.2E+4
	120KHz	1.2E+5	120KHz	1.2E+5
	1MHz	1E+6	1MHz	1E+6
None for 2ND display		0		0

## ●CALCulate Subsystem :

### **CALCulate:MODE?**

Description : Query the calculate mode type.

Response : <literal> format ; Return the type string :

DBM - dBm calculate.

REC - record calculate

LIM - comparator calculate

REL - relative calculate

NOR - normal mode

Example : Return "LIM,DBM,REC", the status is comparator, dBm and record mode on.

### **CALCulate:DBM[:STAT] <Boolean>**

Description : Enable or disable the dBm calculation mode.

Parameter : <Boolean> ( 0n,1; off,0 )

### **CALCulate:DBM:IMPedance <reference>**

Description : Set dBm reference impedance.

Parameter : <reference> ; The allowed value are 2, 4, 8, 16, 50, 75, 93, 110, 124, 125, 135, 150, 250, 300, 500, 600, 800, 900, 1000, 1200, 8000 ohm.

Example : CALC:DBM:IMP 1000 ;Set the dBm impedance value to 1000Ω.

### **CALCulate:RELative[:STAT] <Boolean>**

Description : Enable or disable the relative (REL) calculation mode. When meter enters the relative mode, auto-ranging is disabled and using the primary display reading as the relative base.

Parameter : <Boolean> ( 0n,1; off,0 )

### **CALCulate:RELative:BASE <numeric value>**

Description : Meter enters the relative calculation mode. Auto-ranging is disabled.

Parameter : <numeric value> is a six-digit number ; Relative base: -199999 to +199999.

Example : CALC:REL:BASE 123456 ; Set the relative base to 123456.

Notes: The least setting digit is blank on the display of meter for fast mode. To set least setting digit to "0" for fast mode as necessary.

### **CALCulate:LIMit[:STAT] <Boolean>**

Description : Enable or disable the comparator mode.

Parameter : <Boolean> ( 0n,1; off,0 )

## **CALCulate**

### **:LIMit**

**:UPPer** [**:DATA**] <numeric value>

**:LOWer** [**:DATA**] <numeric value>

Description : Set the compare limits values ( upper and lower limit value).

Parameter : <numeric value> is a six-digit number; For value range : -199999 to +199999.

Example : CALC:UPP 123456 ; Set the upper limit value to 123456

CALC:LOW -123456 ; Set the lower limit value to -123456

Notes: The least setting digit is blank on the display of meter for fast mode. To set least setting digit to "0" for fast mode as necessary.

### **CALCulate:LIMit:FAIL?**

Description : Return the compare result.

Response : 1 (HI) , 0 (PASS) . -1 (LO).

## **CALCulate**

### **:RECOrd**

**:MAXimum**

**:MINimum**

Description : Set the dynamic recording mode. The dynamic recording mode causes the meter to store the minimum and maximum readings.

Example : CALC:REC:MAX ; Set the meter to maximum recording mode.

CALC:REC:MIN ; Set the meter to minimum recording mode.

## **• READING Subsystem:**

**READ?** [ [ ,@1 ] | ,@2 ]

Description : Return the display value of output buffer after the next triggered measurement is complete. Use @1 to select the primary display, and @2 to select the secondary display.

Response : Numeric data transferred as ASCII byte in <NR3> format.

Example : READ? ; Return the value shown on the primary display. For example, might output: " +12.3456E+0 "

**READ??**

Description : Return both display values of output buffer after the next triggered measurement is complete.

Response : Numeric data transferred as ASCII byte in <NR3>,<NR3> format.

Example : READ?? ; For example , might output : " +1.23456E+0,12.34566E+0 "

- **SYSTEM Subsystem** : ( SCPI approved ).

**SYSTEM:VERSION?**

Description : Return the firmware version of the meter.

**SYSTEM:ERROR?**

Description : Return the next message from the system error queue.

Response : <string> format, Table 7-5 is a list of SCPI error message that might occur during operation.

**Table 7-5. SCPI Error Message**

Number	Error String	Number	Error String
0	No error	-108	Parameter not allowed
-100	Command error	-109	Missing parameter
-102	Syntax error	-200	Execution error
-103	Invalid separator	-222	Data out of range
-104	Data type error	-224	Illegal parameter value

### 7-5-3 SCPI Command Summary

Command	Parameter	Std/New	Explanation
ABOUT		Std	Event, no query
CONFigure[:SCALar]		Std	Configure meter to perform specified measurement.
<b>:CURRent</b>		New	Set the current measurement mode.
<b>:AC</b>	[<numeric value>] [[, @1], @2]	New	
<b>:ACDC</b>			
<b>:DCAC</b>	[<numeric value>] [, @1]	New	
<b>:DC</b>	[<numeric value>] [[, @1], @2]	New	
<b>:DIOCTest</b>		New	Set the primary display to diode with the continuity test.
<b>:DISPlay</b>		New	Set and query the measurement rate type.
<b>:RATE</b>	<SLOW MED FAST>	New	
<b>:RATE?</b>		New	
<b>:FREQuency</b>	[<numeric value>] [[, @1], @2]	New	Set the meter to frequency measuring.
<b>:FUNCTion?</b>	[[, @1], @2]	New	Query the measurement function.
<b>:OFFDual</b>		New	Turn off the 2ND display.
<b>:OFFRecord</b>		New	Turn off the dynamic recording mode.
<b>:RANGe</b>		Std	Set the measurement range.
<b>:AUTO</b>	<Boolean>[[, @1], @2]	New	
<b>:AUTO?</b>	[[, @1], @2]	New	
<b>:DIRection</b>	<UP DOWN> [[, @1], @2]	New	
<b>:RANGe?</b>	[[, @1], @2]	New	Query the measurement range.
<b>:RESistance</b>		New	Set the resistance measurement mode.
<b>[:2W]</b>	[<numeric value>]	New	
<b>:4W</b>	[<numeric value>]	New	
<b>:VOLTage</b>		New	Set the voltage measurement mode.
<b>:AC</b>	[<numeric value>] [[, @1], @2]	New	
<b>:ACDC</b>			
<b>:DCAC</b>	[<numeric value>] [, @1]	New	
<b>:DC</b>	[<numeric value>] [[, @1], @2]	New	

Command	Parameter	Std/New	Explanation
CALCulate		Std	Set the calculation function.
:DBM		New	Set dBm reference impedance
:IMPedance	<reference>	New	
[:STAT]	<Boolean>	New	
:LIMit		Std	Set and query the comparator.
:FAIL?		Std	
:LOWer[:DATA]	<number value>	Std	
[:STAT]	<Boolean>	New	
:UPPer[:DATA]	<number value>	Std	
:RECORD		New	Set the dynamic recording mode.
:MAXimum		New	
:MINimum		New	
:RELative		New	Set the relative base.
:BASE	<number value>	New	
[:STAT]	<Boolean>	New	
:MODE?		New	Query the calculation function.
INITiate[IMMEDIATE]		Std	Reset meter without changing setup
:CONTinuous	<Boolean>	Std	Set the meter at free run or data hold operation mode.
:CONTinuous?		New	Query the operation mode.
READ?	[[, @1], @2]	Std	Read the display value.
READ??		New	Read the both display values.
SYSTEM		Std	Subsystem
:ERRor?		Std	Read the error message.
:VERSion?		Std	Return the firmware version.

**Note:** “Std” commands means defined in SCPI standard and “New” commands are not defined.

## 7-6 Remote Program Examples using GPIB interface

### • Example Using Quick BASIC

GPIBEXAMPLE.BAS

This sample program is for reference only. It can only be expected to function with a Digital Multimeter.

This program reads 10 measurements from the meter and averages the sum.

The status variables IBSTA%, IBERR%, and IBCNT% are defined in QBDECL.BAS. Each bit of IBSTA% and each value of IBERR% are defined in QBDECL.BAS as a mnemonic constant for easy recognition in application programs. In this example, these mnemonic definitions are logically ANDed with the variable IBSTA% to determine if a particular bit has been set. The mnemonic definitions are equated with the variable IBERR% to determine the error code.

The subroutine GPIBERR is called when a NI-488 function fails. The error message is printed along with the status variables IBSTA%, IBERR%, and IBCNT%. The subroutine DVMERR is called when the serial poll response byte indicates the meter does not have valid data to send. The error message and the serial poll response byte are printed.

The NI-488 function IBONL is called from the main body of the program or from the two subroutines, GPIBERR and DVMERR. When the second parameter of the function IBONL is zero, the software and hardware are disabled. Execution of this program is terminated after the call to the function IBONL to disable the software and hardware.

The STOP command or END command will terminate this program.

---

QBDECL.BAS contains constants, declarations, and subroutine prototypes.

***REM \$INCLUDE: 'qbdecl.bas'***

GPIBERR is an error subroutine that is called when a NI-488 function fails. DVMERR is an error subroutine that is called when the meter does not have valid data to send.

***DECLARE SUB gpiberr (msg\$)***  
***DECLARE SUB dvmerr (msg\$, spr%)***

***CLS***  
***PRINT "Read 10 measurements from the meter..."***  
***PRINT***

Assign a unique identifier to the meter and store in the variable DVM. IBDEV opens an available device and assigns it to access GPIB0 with a primary address of 1, a secondary address of 0, a timeout of 10 seconds, the END message enabled, and the EOS mode disabled. If DVM is less than zero, call GPIBERR with an error message.

***CALL ibdev(0, 1, 0, T10s, 1, 0, dvm%) IF (dvm% < 0) THEN CALL gpiberr("Ibdev Error")***

' Clear the internal or device functions of the meter. If the error bit  
' EERR is set in IBSTA%, call GPIBERR with an error message.

```
CALL ibclr(dvm%)  
IF (ibsta% AND EERR) THEN CALL gpiberr("Ibclr Error")
```

Reset the meter by issuing the reset (\*RST) command. Instruct the meter to measure the volts alternating current (VAC) using auto-ranging (AUTO). If the error bit EERR is set in IBSTA%, call GPIBERR with an error message.

```
wrt$ = "*RST"  
CALL ibwrt(dvm%, wrt$)  
IF (ibsta% AND EERR) THEN CALL gpiberr("Ibwrt Error")
```

```
wrt$ = "CONF:VOLT:AC"  
CALL ibwrt(dvm%, wrt$)  
IF (ibsta% AND EERR) THEN CALL gpiberr("Ibwrt Error")
```

Initialize the accumulator of the 10 measurements to zero.

```
sum = 0!
```

Establish FOR loop to read the 10 measurements. The variable i% will serve as a counter for the FOR loop.

```
FOR i% = 1 TO 10
```

```
' Request the measurement by sending the instruction  
' "READ?". If the error bit EERR is set in IBSTA%, call GPIBERR  
' with an error message.
```

```
wrt$ = "READ?"  
CALL ibwrt(dvm%, wrt$)  
IF (ibsta% AND EERR) THEN CALL gpiberr("Ibwrt Error")
```

```
' Read the meter measurement. If the error bit EERR is set in  
' IBSTA%, call GPIBERR with an error message.
```

```
rd$ = SPACE$(11)  
CALL ibrd(dvm%, rd$)  
IF (ibsta% AND EERR) THEN CALL gpiberr("Ibrd Error")
```

```
' Remove blank spaces in RD$ and assign resulting buffer to READING$.  
' Print measurement returned by the meter.
```

```
reading$ = LEFT$(rd$, ibcnt%)  
PRINT "reading: "; reading$
```

```
' Convert READING$ to its numeric value and add to the accumulator.
```

```
sum = sum + VAL(reading$)
```

```
NEXT i% ' Continue FOR loop until 10 measurements are read.
```

Print the average of the 10 readings.

```
PRINT "The average of the 10 readings is: ", sum / 10
```

Call the IBONL function to disable the hardware and software.



***CALL ibonl(dvm%, 0)***

***END***

-----  
'  
' Subroutine DVMERR  
'  
'  
' This subroutine will notify you that the meter returned an invalid  
' serial poll response byte. The error message will be printed along with  
' the serial poll response byte.  
'  
' The NI-488 function IBONL is called to disable the hardware and software.  
'  
' The STOP command will terminate this program.  
-----  
'

***SUB dvmerr (msg\$, spr%) STATIC***

***PRINT msg\$***

***PRINT "Status Byte = &H"; HEX\$(spr%)***

' Call the IBONL function to disable the hardware and software.

***CALL ibonl(dvm%, 0)***

***STOP***

***END SUB***

-----  
'  
' Subroutine GPIBERR  
' This subroutine will notify you that a NI-488 function failed by printing  
' an error message. The status variable IBSTA% will also be printed  
' in hexadecimal along with the mnemonic meaning of the bit position.  
' The status variable IBERR% will be printed in decimal along with the  
' mnemonic meaning of the decimal value. The status variable IBCNT% will  
' be printed in decimal.  
'  
' The NI-488 function IBONL is called to disable the hardware and software.  
'  
' The STOP command will terminate this program.  
-----  
'

***SUB gpiberr (msg\$) STATIC***

***PRINT msg\$***

***PRINT "ibsta = &H"; HEX\$(ibsta%); " <";***

***IF ibsta% AND EERR THEN PRINT " ERR";***

***IF ibsta% AND TIMO THEN PRINT " TIMO";***

***IF ibsta% AND EEND THEN PRINT " END";***

***IF ibsta% AND SRQI THEN PRINT " SRQI";***

***IF ibsta% AND RQS THEN PRINT " RQS";***

***IF ibsta% AND SPOLL THEN PRINT " SPOLL";***

***IF ibsta% AND EEVENT THEN PRINT " EVENT";***

***IF ibsta% AND CMPL THEN PRINT " CMPL";***

```

IF ibsta% AND LOK THEN PRINT " LOK";
IF ibsta% AND RREM THEN PRINT " REM";
IF ibsta% AND CIC THEN PRINT " CIC";
IF ibsta% AND AATN THEN PRINT " ATN";
IF ibsta% AND TACS THEN PRINT " TACS";
IF ibsta% AND LACS THEN PRINT " LACS";
IF ibsta% AND DTAS THEN PRINT " DTAS";
IF ibsta% AND DCAS THEN PRINT " DCAS";
PRINT ">"
PRINT "iberr = "; iberr%;

```

```

IF iberr% = EDVR THEN PRINT " EDVR <DOS Error>"
IF iberr% = ECIC THEN PRINT " ECIC <Not CIC>"
IF iberr% = ENOL THEN PRINT " ENOL <No Listener>"
IF iberr% = EADR THEN PRINT " EADR <Address error>"
IF iberr% = EARG THEN PRINT " EARG <Invalid argument>"
IF iberr% = ESAC THEN PRINT " ESAC <Not Sys Ctrlr>"
IF iberr% = EABO THEN PRINT " EABO <Op. aborted>"
IF iberr% = ENEB THEN PRINT " ENEB <No GPIB board>"
IF iberr% = EOIP THEN PRINT " EOIP <Async I/O in prg>"
IF iberr% = ECAP THEN PRINT " ECAP <No capability>"
IF iberr% = EFSO THEN PRINT " EFSO <File sys. error>"
IF iberr% = EBUS THEN PRINT " EBUS <Command error>"
IF iberr% = ESTB THEN PRINT " ESTB <Status byte lost>"
IF iberr% = ESRQ THEN PRINT " ESRQ <SRQ stuck on>"
IF iberr% = ETAB THEN PRINT " ETAB <Table Overflow>"

```

```

PRINT "ibcnt = "; ibcnt%

```

' Call the IBONL function to disable the hardware and software.

```

CALL ibonl(dvm%, 0)

```

```

STOP

```

```

END SUB

```

# Appendix A

## 5492 Specifications

### A-1 Introduction

Appendix A describes the complete specifications of the 5492 5 1/2 Digit Dual Display Multimeter.

### A-2 Technical Specifications

- **Specifications assumptions:**

- One-year calibration cycle.
- Operating temperature at 18°C to 28°C (64.4°F to 82.4°F).
- Accuracy is expressed as:  $\pm$  (% of reading + digits) after 30 minutes warm-up.
- Temperature coefficient: Add  $\pm$  [0.15 x (the applicable accuracy)/°C] for 0°C to 18°C and 28°C to 50°C.
- Relative Humidity (RH) up to 80% for 0°C to 28°C (75% RH for 12M $\Omega$  and above ranges of resistance measurement); up to 70% for 28°C to 35°C; up to 50% for 35°C to 50°C
- All specifications are specified under single display mode in operation only.

- **Display Counts and Reading Rates**

#### Full Scale Display Counts

Slow	Medium	Fast
119,999	39,999	3,999

#### Reading Rates on Single Display (Readings/Sec)

Measurement Functions	Slow	Medium	Fast
DCV	2	5	20
DCA	2	5	20
Diode	2	5	20
ACV	2	4.2	20
ACA	2	4.2	20
2-wires $\Omega$	2	4	17
4-wires $\Omega$ 4M $\Omega$ /1.2M $\Omega$ range and below	0.6	0.8	0.9
4-wires $\Omega$ 12M $\Omega$ range and above	1.4	1.7	1.9
Frequency	1.2	1.7	2.4
ACV+DCV	0.4	0.5	0.7
ACA+DCA	0.4	0.5	0.7

### Reading Rates on Dual Display (Readings/Sec)

Measurement Functions	Slow	Medium	Fast
DCV / ACV	0.7	1.0	1.9
DCA / ACA	0.7	1.0	1.9
DCV / DCA	0.7	1.0	1.9
DCV / ACA	0.2	0.2	0.5
ACV / ACA	0.2	0.2	0.5
ACV / DCA	0.7	1.0	1.9
ACV / Frequency	0.5	0.7	1.1
ACA / Frequency	0.6	0.8	1.3
ACV+DCV / DCV	0.5	0.6	0.9
ACA+DCA / DCV	0.1	0.2	0.4
ACA+DCA / ACV	0.1	0.2	0.4
ACA+DCA / DCA	0.5	0.6	0.9
dBm(ACV) / Reference $\Omega$	2.1	4.2	11.9
dBm(ACV) / ACV	0.7	1.0	1.7
dBm(ACV) / DCV	0.6	1.0	1.7
dBm(ACV) / Frequency	0.7	1.0	1.7

**Note 1:** Above table shows some common combinations and applications of using dual display.

**Note 2:** Using RS-232 or GPIB remote interface, the reading rate approximates to normal mode.

● DC Voltage

**Resolution, Full Scale Reading and Accuracy**

Rate <sup>(1)</sup>	Range	Resolution	Full Scale Reading	Accuracy (1 year)	Typical Input Impedance <sup>(4)</sup>
S	120mV	1μV	119.999	0.012% + 8 <sup>(2)</sup>	10.0MΩ
	1.2V	10μV	1.19999	0.012% + 5	10.0MΩ
	12V	100μV	11.9999	0.012% + 5	11.1MΩ
	120V	1mV	119.999	0.012% + 5	10.1MΩ
	1000V	10mV	1000.00 <sup>(3)</sup>	0.012% + 5	10.0MΩ
M	400mV	10μV	399.99	0.012% + 5	10.0MΩ
	4V	100μV	3.9999	0.012% + 5	11.1MΩ
	40V	1mV	39.999	0.012% + 5	10.1MΩ
	400V	10mV	399.99	0.012% + 5	10.0MΩ
	1000V	100mV	1000.0 <sup>(3)</sup>	0.012% + 5	10.0MΩ
F	400mV	100μV	399.9	0.012% + 2	10.0MΩ
	4V	1mV	3.999	0.012% + 2	11.1MΩ
	40V	10mV	39.99	0.012% + 2	10.1MΩ
	400V	100mV	399.9	0.012% + 2	10.0MΩ
	1000V	1V	1000 <sup>(3)</sup>	0.012% + 2	10.0MΩ

<sup>(1)</sup> Rate: S (Slow), M (Medium), and F (Fast).  
<sup>(2)</sup> Use relative (REL) modifier.  
<sup>(3)</sup> In Vdc 1000V range, 5% over-range (1050Vdc) is readable.  
<sup>(4)</sup> Input Impedance is in paralleled with capacitance <120pF.

- Maximum input voltage: 1000Vdc or peak ac on any range
- Response Time: Approximately 1.0 second when the displayed reading reaches 99.9% dc value of the tested input signal at the same range.

*Note: When voltage (ac+dc) measurement function is selected, the Vdc input impedance is paralleled with an ac-coupled 1.1MΩ ac divider.*

**Noise Rejection Ratio**

Rate	CMRR <sup>(1)</sup>	NMRR <sup>(2)</sup>
S / M / F	>90dB at dc, 50/60Hz ± 0.1% (1kΩUnbalanced)	>50dB at 50/60Hz ± 0.1%

<sup>(1)</sup> CMRR is the Common Mode Reject Ratio  
<sup>(2)</sup> NMRR is the Normal Mode Rejection Ratio

- AC Voltage (True RMS, AC Coupling Mode)

### Resolution and Full Scale Reading

Range		Resolution			Full Scale Reading		
S	M & F	S	M	F	S	M	F
120mV	400mV	1μV	10μV	100μV	119.999	399.99	399.9
1.2V	4V	10μV	100μV	1mV	1.19999	3.9999	3.999
12V	40V	100μV	1mV	10mV	11.9999	39.999	39.99
120V	400V	1mV	10mV	100mV	119.999	399.99	399.9
750V	750V	10mV	100mV	1V	750.00 <sup>(1)</sup>	750.0 <sup>(1)</sup>	750 <sup>(1)</sup>

<sup>(1)</sup> In Vac 750V range, 5% over-range (787.5V rms) is readable

### Accuracy

Rate	Range	Accuracy (1 year) <sup>(1)</sup>			
		20 to 45 Hz	45 to 10k Hz	10 to 30 kHz	30 to 100 kHz
S	120.000mV	1% + 100	0.2% + 100	1.5% + 300	5% + 300
	1.20000V	1% + 100	0.2% + 100	1% + 100	3% + 200
	12.0000V	1% + 100	0.2% + 100	1% + 100	3% + 200
	120.000V	1% + 100	0.2% + 100	1% + 100	3% + 200
	750.00V	1% + 100 <sup>(2)</sup>	0.2% + 100	1% + 100	3% + 200 <sup>(3)</sup>
M	400.00mV	1% + 40	0.2% + 40	1.5% + 80	5% + 120
	4.0000V	1% + 40	0.2% + 40	1% + 40	3% + 80
	40.000V	1% + 40	0.2% + 40	1% + 40	3% + 80
	400.00V	1% + 40 <sup>(2)</sup>	0.2% + 40	1% + 40	3% + 80
	750.0V	1% + 40 <sup>(2)</sup>	0.2% + 40	1% + 40	3% + 80 <sup>(3)</sup>
F	400.0mV	1% + 5	0.2% + 5	1.5% + 10	5% + 15
	4.000V	1% + 5	0.2% + 5	1% + 5	3% + 10
	40.00V	1% + 5	0.2% + 5	1% + 5	3% + 10
	400.0V	1% + 5 <sup>(2)</sup>	0.2% + 5	1% + 5	3% + 10
	750V	1% + 5 <sup>(2)</sup>	0.2% + 5	1% + 5	3% + 10 <sup>(3)</sup>

<sup>(1)</sup> Specified accuracy at input >5% of full scale

<sup>(2)</sup> For input <200V rms

<sup>(3)</sup> For input <500V rms

- Measurement method: True RMS
- Maximum Crest Factor: 3.0 at full scale
- Maximum input voltage: 750V rms, 1100V peak ac
  - 2x10<sup>7</sup> V-Hz product on any range, normal mode input
  - 1x10<sup>6</sup> V-Hz product on any range, common mode input
- Input Impedance: 1MΩ in parallel with capacitance <120pF
- Response Time: Approximately 1.5 seconds when the displayed reading reaches 99.9% ac rms value of the tested input signal at the same range.

- AC Voltage (True RMS, AC+DC Coupling Mode)

### Resolution and Full Scale Reading

Range <sup>(1)</sup>		Resolution			Full Scale Reading		
S	M & F	S	M	F	S	M	F
120mV	400mV	1μV	10μV	100μV	119.999	399.99	399.9
1.2V	4V	10μV	100μV	1mV	1.19999	3.9999	3.999
12V	40V	100μV	1mV	10mV	11.9999	39.999	39.99
120V	400V	1mV	10mV	100mV	119.999	399.99	399.9
750V	750V	10mV	100mV	1V	750.00 <sup>(2)</sup>	750.0 <sup>(2)</sup>	750 <sup>(2)</sup>

<sup>(1)</sup> Vdc and Vac are automatically set at the same range  
<sup>(2)</sup> In Vac 750V range, 5% over-range (787.5V rms) is readable

### Accuracy

Rate	Range	Accuracy (1 year) <sup>(1)</sup>		
		45 to 10k Hz	10 to 30 kHz	30 to 100 kHz
S	120.000mV	0.2% + 100	1.5% + 300	5% + 300
	1.20000V	0.2% + 100	1% + 100	3% + 200
	12.0000V	0.2% + 100	1% + 100	3% + 200
	120.000V	0.2% + 100	1% + 100	3% + 200
	750.00V	0.2% + 100	1% + 100	3% + 200 <sup>(2)</sup>
M	400.00mV	0.2% + 45	1.5% + 83	5% + 125
	4.0000V	0.2% + 43	1% + 43	3% + 83
	40.000V	0.2% + 43	1% + 43	3% + 83
	400.00V	0.2% + 43	1% + 43	3% + 83
	750.0V	0.2% + 43	1% + 43	3% + 83 <sup>(2)</sup>
F	400.0mV	0.2% + 7	1.5% + 12	5% + 18
	4.000V	0.2% + 7	1% + 7	3% + 12
	40.00V	0.2% + 7	1% + 7	3% + 12
	400.0V	0.2% + 7	1% + 7	3% + 12
	750V	0.2% + 7	1% + 7	3% + 12 <sup>(2)</sup>

<sup>(1)</sup> Specified accuracy at input >5% of full scale      <sup>(2)</sup> For input <500V rms

- Measurement method: True RMS AC+DC
- Maximum Crest Factor: 3.0 at full scale
- Maximum input voltage: 750V rms, 1100V peak ac
  - 2x10<sup>7</sup> V-Hz product on any range, normal mode input
  - 1x10<sup>6</sup> V-Hz product on any range, common mode input
- Input Impedance: 1MΩ in parallel with capacitance <120pF
- Response Time: Approximately 2.5 seconds when the displayed reading reaches 99.9% (ac+dc) rms value of the tested input signal at the same range.

- DC Current

Rate	Range	Resolution	Full Scale Reading	Accuracy (1 year)	Burden Voltage <sup>(1)</sup> & Shunt Resistor
S	12mA	0.1μA	11.9999	0.05% + 15 <sup>(2)</sup>	<0.15V / 10Ω
	120mA	1μA	119.999	0.05% + 5	<1.5V / 10Ω
	1200mA	10μA	1199.99	0.15% + 5	<0.3V / 0.1Ω
	12A	100μA	11.9999	0.2% + 5	<0.6V / 0.01Ω
M	40mA	1μA	39.999	0.1% + 6	<0.5V / 10Ω
	120mA	10μA	119.99	0.1% + 3	<1.5V / 10Ω
	1200mA	100μA	1199.9	0.15% + 3	<0.3V / 0.1Ω
	12A	1mA	11.999	0.2% + 3	<0.6V / 0.01Ω
F	40mA	10μA	39.99	0.1% + 2	<0.5V / 10Ω
	120mA	100μA	119.9	0.1% + 2	<1.5V / 10Ω
	1200mA	1mA	1199	0.15% + 2	<0.3V / 0.1Ω
	12A	10mA	11.99	0.2% + 2	<0.6V / 0.01Ω
<sup>(1)</sup> Typical at full scale reading and voltage across the input terminals					
<sup>(2)</sup> Use relative (REL) modifier					

- Maximum Input and Overload Current Protection (for dc and ac current):  
 mA Input Terminal: 1200mA dc or ac rms and protected with 2A/250V, IEC-127 sheet 1 fast blow fuse;  
 12A input terminal: 10A dc or ac rms continuous, or 12A dc or ac rms for 30 seconds maximum and protected with 15A/500V, breaking capacity 10,000A fast blow fuse.
- Response Time: Approximately 1.0 second when the displayed reading reaches 99.9% dc value of the tested input signal at the same range.



- AC Current (True RMS, AC Coupling Mode)

### Resolution, Full Scale Reading and Burden Voltage

Rate	Range	Resolution	Full Scale Reading	Burden Voltage <sup>(1)</sup> & Shunt Resistor
S	12mA	0.1μA	11.9999	<0.15V / 10Ω
	120mA	1μA	119.999	<1.5V / 10Ω
	1200mA	10μA	1199.99	<0.3V / 0.1Ω
	12A	100μA	11.9999	<0.6V / 0.01Ω
M	40mA	1μA	39.999	<0.5V / 10Ω
	120mA	10μA	119.99	<1.5V / 10Ω
	1200mA	100μA	1199.9	<0.3V / 0.1Ω
	12A	1mA	11.999	<0.6V / 0.01Ω
F	40mA	10μA	39.99	<0.5V / 10Ω
	120mA	100μA	119.9	<1.5V / 10Ω
	1200mA	1mA	1199	<0.3V / 0.1Ω
	12A	10mA	11.99	<0.6V / 0.01Ω

<sup>(1)</sup> Typical at full scale reading and rms voltage across the input terminals

### Accuracy

Rate	Range	Accuracy (1 year) <sup>(1)</sup>		
		20 to 45 Hz	45 to 2k Hz	2 to 10 kHz
S	12mA	1.5% + 100	0.5% + 100	2% + 200
	120mA	1.5% + 100	0.5% + 100	2% + 200
	1200mA	1.5% + 100	0.5% + 100	2% + 200
	12A	2% + 100 (<1.2A)	1% + 100	-
M	40mA	1.5% + 40	0.5% + 40	2% + 80
	120mA	1.5% + 12	0.5% + 12	2% + 30
	1200mA	1.5% + 12	0.5% + 12	2% + 30
	12A	2% + 12 (<1.2A)	1% + 12	-
F	40mA	1.5% + 5	0.5% + 5	2% + 10
	120mA	1.5% + 2	0.5% + 2	2% + 5
	1200mA	1.5% + 2	0.5% + 2	2% + 5
	12A	2% + 2 (<1.2A)	1% + 2	-

<sup>(1)</sup> Specified accuracy at input >5% of full scale

- Measurement method: True RMS
- Maximum Crest Factor: 3.0 at full scale
- Response Time: Approximately 1.5 seconds when the displayed reading reaches 99.9% ac rms value of the tested input signal at the same range.

- AC Current (True RMS, AC+DC Coupling Mode)

### Resolution, Full Scale Reading and Burden Voltage

Rate	Range	Resolution	Full Scale Reading	Burden Voltage <sup>(1)</sup> & Shunt Resistor
S	12mA	0.1μA	11.9999	<0.15V / 10Ω
	120mA	1μA	119.999	<1.5V / 10Ω
	1200mA	10μA	1199.99	<0.3V / 0.1Ω
	12A	100μA	11.9999	<0.6V / 0.01Ω
M	40mA	1μA	39.999	<0.5V / 10Ω
	120mA	10μA	119.99	<1.5V / 10Ω
	1200mA	100μA	1199.9	<0.3V / 0.1Ω
	12A	1mA	11.999	<0.6V / 0.01Ω
F	40mA	10μA	39.99	<0.5V / 10Ω
	120mA	100μA	119.9	<1.5V / 10Ω
	1200mA	1mA	1199	<0.3V / 0.1Ω
	12A	10mA	11.99	<0.6V / 0.01Ω

<sup>(1)</sup> Typical at full scale reading and rms voltage across the input terminals

### Accuracy

Rate	Range	Accuracy (1 year) <sup>(1)</sup>	
		45 to 2k Hz	2 to 10 kHz
S	12mA	0.5% + 100	2% + 200
	120mA	0.5% + 100	2% + 200
	1200mA	0.5% + 100	2% + 200
	12A	1% + 100	-
M	40mA	0.5% + 42	2% + 80
	120mA	0.5% + 15	2% + 30
	1200mA	0.5% + 15	2% + 30
	12A	1% + 15	-
F	40mA	0.5% + 7	2% + 12
	120mA	0.5% + 4	2% + 7
	1200mA	0.5% + 4	2% + 7
	12A	1% + 4	-

<sup>(1)</sup> Specified accuracy at input >5% of full scale

- Measurement range: Vdc and Vac are automatically set at the same range
- Measurement method: True RMS AC+DC
- Maximum Crest Factor: 3.0 at full scale
- Response Time: Approximately 2.5 seconds when the displayed reading reaches 99.9% (ac+dc) rms value of the tested input signal at the same range.

- Resistance (2-wire  $\Omega$  and 4-wire  $\Omega$ )

Rate	Range <sup>(1)</sup>	Resolution	Full Scale Reading	Test Current	Accuracy (1 year)	
					2-wire	4-wire
S	120 $\Omega$	1m $\Omega$	119.999	0.5mA	0.1% + 8 <sup>(2)</sup>	0.05% + 8 <sup>(2)</sup>
	1.2k $\Omega$	10m $\Omega$	1.19999	0.5mA	0.08% + 5 <sup>(2)</sup>	0.05% + 5 <sup>(2)</sup>
	12k $\Omega$	100m $\Omega$	11.9999	100 $\mu$ A	0.06% + 5 <sup>(2)</sup>	0.05% + 5
	120k $\Omega$	1 $\Omega$	119.999	10 $\mu$ A	0.06% + 5	0.05% + 5
	1.2M $\Omega$	10 $\Omega$	1.19999	1 $\mu$ A	0.06% + 5	0.05% + 5
	12M $\Omega$	100 $\Omega$	11.9999	100nA	0.3% + 5	0.3% + 5
	120M $\Omega$	1k $\Omega$	119.999	10nA	3.0% + 8	3.0% + 8
M	400 $\Omega$	10m $\Omega$	399.99	0.5mA	0.1% + 5 <sup>(2)</sup>	0.05% + 5 <sup>(2)</sup>
	4k $\Omega$	100m $\Omega$	3.9999	100 $\mu$ A	0.08% + 3 <sup>(2)</sup>	0.05% + 3
	40k $\Omega$	1 $\Omega$	39.999	50 $\mu$ A	0.06% + 3	0.05% + 3
	400k $\Omega$	10 $\Omega$	399.99	5 $\mu$ A	0.06% + 3	0.05% + 3
	4M $\Omega$	100 $\Omega$	3.9999	500nA	0.15% + 3	0.15% + 3
	40M $\Omega$	1K $\Omega$	39.999	50nA	1.5% + 3	1.5% + 3
	300M $\Omega$	10k $\Omega$	299.99	10nA	5.0% + 5	5.0% + 5
F	400 $\Omega$	100m $\Omega$	399.9	0.5mA	0.1% + 2 <sup>(2)</sup>	0.05% + 2
	4k $\Omega$	1 $\Omega$	3.999	100 $\mu$ A	0.08% + 2	0.05% + 2
	40k $\Omega$	10 $\Omega$	39.99	50 $\mu$ A	0.06% + 2	0.05% + 2
	400k $\Omega$	100 $\Omega$	399.9	5 $\mu$ A	0.06% + 2	0.05% + 2
	4M $\Omega$	1k $\Omega$	3.999	500nA	0.15% + 2	0.15% + 2
	40M $\Omega$	10k $\Omega$	39.99	50nA	1.5% + 2	1.5% + 2
	300M $\Omega$	100k $\Omega$	299.9	10nA	5.0% + 2	5.0% + 2

<sup>(1)</sup> In order to eliminate the noise interference, which might be induced to the test leads, it is recommended to use a shielded test cable for measuring resistance above 120K $\Omega$ .

<sup>(2)</sup> Use relative (REL) modifier.

- Open Circuit Voltage: < +5.0V dc
- Zeroing error: 0.05 $\Omega$  or less (excluding test lead resistances) in each range when REL modifier is used
- Response time: Approximately 1.5 seconds for 12M $\Omega$  and ranges below 12M $\Omega$ ; approximately 5 seconds for 40M $\Omega$  range; approximately 10 seconds for 120M $\Omega$  ; approximately 25 seconds for 300M $\Omega$  range.
- Maximum Input Protection: 500V dc or ac rms

- **Diode Test/Continuity**

Rate	Maximum Reading	Resolution
S	1.19999V	10 $\mu$ V
M	2.4999V	100 $\mu$ V
F	2.499V	1mV

- Open Circuit Voltage: < +5.0V dc
- Test Current: Approximately 0.5mA dc
- Audible Tone: Continuous beep for continuity and single tone for normal forward-biased diode or semiconductor junction
- Continuity level: Approximately below +50mVdc
- Maximum Input Protection: 500V dc or ac rms

- **Resistance/Continuity (2-wire)**

Rate	Range	Resolution	Maximum Reading	Accuracy
S	120 $\Omega$	1m $\Omega$	119.999	0.1% + 8 <sup>(1)</sup>
M	400 $\Omega$	10m $\Omega$	399.99	0.1% + 5 <sup>(1)</sup>
F	400 $\Omega$	100m $\Omega$	399.9	0.1% + 2 <sup>(1)</sup>

<sup>(1)</sup> Use relative (REL) modifier

- Open Circuit Voltage: < +5.0V dc
- Test Current: Approximately 0.5mA dc
- Audible Tone: Continuous beep for reading is less than 10 $\Omega$
- Zeroing error: 0.05 $\Omega$  or less (excluding test lead resistances) in each range when REL modifier is used
- Maximum Input Protection: 500V dc or ac rms

- **Frequency**

**Resolution, Full Scale Reading and Accuracy**

Range (Hz)	Measurement Range (Hz)	Resolution (Hz)	Full Scale Reading	Accuracy (1 year) <sup>(1)</sup>	Input Sensitivity (Sine wave)
1200	5 to 1200	10m	1199.99	0.005 + 3	40mV rms
12k	10 to 12k	100m	11.9999	0.005 + 2	
120k	100 to 120k	1	119.999	0.005 + 2	
1M <sup>(2)</sup>	1k to 1M	10	1.19999	0.005 + 2	0.5V rms
<sup>(1)</sup> Specified accuracy at input >5% of full scale <sup>(2)</sup> If tested frequency is greater than 1MHz, it will be displayed but no specified accuracy is guaranteed.					

- **Measurement method: True RMS**
- **Maximum Crest Factor: 3.0 at full scale**
- **Maximum input voltage: 750V rms, 1100V peak ac**
  - $2 \times 10^7$  V-Hz product on any range, normal mode input
  - $1 \times 10^6$  V-Hz product on any range, common mode input
- **Input Impedance: 1MΩ in parallel with capacitance <120pF**
- **Response Time: Approximately 1.2 seconds when the displayed reading reaches 99.9% frequency value of the tested input signal at the same range.**

- dBm (decibel calculation)

### Reference Impedance <sup>(1)</sup>

2Ω <sup>(2)</sup>	50Ω	135Ω	800Ω
4Ω <sup>(2)</sup>	75Ω	150Ω	900Ω
8Ω <sup>(2)</sup>	93Ω	250Ω	1000Ω
16Ω <sup>(2)</sup>	110Ω	300Ω	1200Ω
	124Ω	500Ω	8000Ω
	125Ω	600Ω <sup>(3)</sup>	

<sup>(1)</sup> Reference impedance is displayed on the secondary display

<sup>(2)</sup> Reading displayed in watts (Audio Power)

<sup>(3)</sup> Default reference impedance

### Range and Accuracy

Rate	Voltage Range <sup>(1,2)</sup>	Input Voltage	dBm <sup>(3)</sup> Range @ 600Ω Ref	Accuracy (dB)		
				20 to 45 Hz	45 to 10k Hz	10 to 100 kHz
S	120mV	6mV ~ 120mV	-42.20 ~ -16.20	1.0	0.2	1.0
	1.2V	120mV ~ 1.2V	-16.20 ~ 3.80	0.8	0.1	0.8
	12V	1.2V ~ 12V	3.80 ~ 23.80	0.8	0.1	0.8
	120V	12V ~ 120V	23.80 ~ 43.80	0.8	0.1	0.8
	1000V (dc)	120V ~ 1000V	43.80 ~ 62.22	-	1.0 <sup>(4)</sup>	-
	750V (ac)	120V ~ 750V	43.80 ~ 59.72	-	1.0 <sup>(4)</sup>	-
M & F	400mV	20mV ~ 400mV	-31.76 ~ -5.74	1.0	0.2	1.0
	4V	400mV ~ 4V	-5.74 ~ 14.26	0.8	0.1	0.8
	40V	4V ~ 40V	14.26 ~ 34.26	0.8	0.1	0.8
	400V	40V ~ 400V	34.26 ~ 54.26	0.8	0.1	0.8
	1000V (dc)	400V ~ 1000V	54.26 ~ 62.22	-	1.0 <sup>(4)</sup>	-
	750V (ac)	400V ~ 750V	54.26 ~ 59.72	-	1.0 <sup>(4)</sup>	-

<sup>(1)</sup> Auto-ranging is used when dBm function is selected

<sup>(2)</sup> In Vac 750V range, 5% over-range is readable

<sup>(3)</sup> Reading displayed in dB when REL modifier is used

<sup>(4)</sup> For input voltage at frequency between 45Hz to 1kHz

- 0dBm: 1 mW @ 600Ω Reference Impedance
- Resolution: 0.01dB at slow and medium rate; 0.1dB at fast rate for all ranges.
- CMRR: > 90dB for dc signal
- Response Time: Same as ac voltage and ac current measurements.

## A-3 General Specifications

General Items	Specifications
Warm up time	At least 30 minutes
Temperature Coefficient	Add 0.15 x (the applicable accuracy)/°C at 0°C to 18°C and 28°C to 50°C
Operating Temperature	0°C to 50°C (32°F to 122°F)
Storage Temperature	-20°C to 60°C
Altitude	Up to 2000 M
Pollution Degree	II
Over-voltage Category	CAT II-600V and CAT I-1000V
Relative Humidity	<ul style="list-style-type: none"> <li>• Up to 80% for 0°C to 28°C (75% RH for 12MΩ and above ranges of resistance measurement)</li> <li>• Up to 70% for 28°C to 35°C</li> <li>• Up to 50% for 35°C to 50°C</li> </ul>
Common Mode Voltage	1000V dc or peak ac rms maximum between any input and earth ground
Dimension	Approx. 255(w) x 105(h) x 305(d) mm (with holsters)
Weight	<3.0kgs
Line Voltage	100V / 120V / 220V / 240V ac ±10%, 50/60Hz, 16VA maximum
Interface	<ul style="list-style-type: none"> <li>• RS-232 (DB-9, male connector)</li> <li>• Baud rates: 9600, 4800, 2400, 1200, 600, 300</li> <li>• Data length: 7 or 8 bits</li> <li>• Parity: even / odd / none</li> <li>• Stop bit: 1 or 2 bits</li> <li>• Echo: on / off</li> <li>• Print mode: on / off</li> </ul>
Safety Requirement	Designed in compliance with EN61010-1 (IEC1010-1)
Installation Category	CAT-I 750VAC/1000VDC or CAT-II 600V, Pollution Degree 2 Environment
EMC Requirement	Designed in compliance with EN61326-1.

# Appendix B

## 5491 Specifications

### B-1 Introduction

Appendix B describes the complete specifications of the 5491 5 1/2 Digit Dual Display Multimeter.

### B-2 Technical Specifications

- **Specifications assumptions:**

- One-year calibration cycle.
- Operating temperature at 18°C to 28°C (64.4°F to 82.4°F).
- Accuracy is expressed as:  $\pm$  (% of reading + digits) after 30 minutes warm-up.
- Temperature coefficient: Add  $\pm$  [0.15 x (the applicable accuracy)/°C] for 0°C to 18°C and 28°C to 50°C.
- Relative Humidity (RH) up to 80% for 0°C to 28°C (75% RH for 12M $\Omega$  and above ranges of resistance measurement); up to 70% for 28°C to 35°C; up to 50% for 35°C to 50°C
- All specifications are specified under single display mode in operation only.

- **Display Counts and Reading Rates**

#### Full Scale Display Counts

Slow	Medium	Fast
119,999	39,999	3,999

#### Reading Rates on Single Display (Readings/Sec)

Measurement Functions	Slow	Medium	Fast
DCV	2	5	20
DCA	2	5	20
Diode	2	5	20
ACV	2	4.2	20
ACA	2	4.2	20
2-wires $\Omega$	2	4	17
4-wires $\Omega$ 4M $\Omega$ /1.2M $\Omega$ range and below	0.6	0.8	0.9
4-wires $\Omega$ 12M $\Omega$ range and above	1.4	1.7	1.9
Frequency	1.2	1.7	2.4
ACV+DCV	0.4	0.5	0.7
ACA+DCA	0.4	0.5	0.7



### Reading Rates on Dual Display (Readings/Sec)

Measurement Functions	Slow	Medium	Fast
DCV / ACV	0.7	1.0	1.9
DCA / ACA	0.7	1.0	1.9
DCV / DCA	0.7	1.0	1.9
DCV / ACA	0.2	0.2	0.5
ACV / ACA	0.2	0.2	0.5
ACV / DCA	0.7	1.0	1.9
ACV / Frequency	0.5	0.7	1.1
ACA / Frequency	0.6	0.8	1.3
ACV+DCV / DCV	0.5	0.6	0.9
ACA+DCA / DCV	0.1	0.2	0.4
ACA+DCA / ACV	0.1	0.2	0.4
ACA+DCA / DCA	0.5	0.6	0.9
dBm(ACV) / Reference $\Omega$	2.1	4.2	11.9
dBm(ACV) / ACV	0.7	1.0	1.7
dBm(ACV) / DCV	0.6	1.0	1.7
dBm(ACV) / Frequency	0.7	1.0	1.7

**Note1:** Above table shows some common combinations and applications of using dual display.

**Note2:** Using RS-232 or GPIB remote interface, the reading rate approximates to normal mode.

- DC Voltage

### Resolution, Full Scale Reading and Accuracy

Rate <sup>(1)</sup>	Range	Resolution	Full Scale Reading	Accuracy (1 year)	Typical Input Impedance <sup>(4)</sup>
S	120mV	1 $\mu$ V	119.999	0.02% + 8 <sup>(2)</sup>	10.0M $\Omega$
	1.2V	10 $\mu$ V	1.19999	0.02% + 5	10.0M $\Omega$
	12V	100 $\mu$ V	11.9999	0.02% + 5	11.1M $\Omega$
	120V	1mV	119.999	0.02% + 5	10.1M $\Omega$
	1000V	10mV	1000.00 <sup>(3)</sup>	0.02% + 5	10.0M $\Omega$
M	400mV	10 $\mu$ V	399.99	0.02% + 5	10.0M $\Omega$
	4V	100 $\mu$ V	3.9999	0.02% + 5	11.1M $\Omega$
	40V	1mV	39.999	0.02% + 5	10.1M $\Omega$
	400V	10mV	399.99	0.02% + 5	10.0M $\Omega$
	1000V	100mV	1000.0 <sup>(3)</sup>	0.02% + 5	10.0M $\Omega$
F	400mV	100 $\mu$ V	399.9	0.02% + 2	10.0M $\Omega$
	4V	1mV	3.999	0.02% + 2	11.1M $\Omega$
	40V	10mV	39.99	0.02% + 2	10.1M $\Omega$
	400V	100mV	399.9	0.02% + 2	10.0M $\Omega$
	1000V	1V	1000 <sup>(3)</sup>	0.02% + 2	10.0M $\Omega$

<sup>(1)</sup> Rate: S (Slow), M (Medium), and F (Fast).

<sup>(2)</sup> Use relative (REL) modifier.

<sup>(3)</sup> In Vdc 1000V range, 5% over-range (1050Vdc) is readable.

<sup>(4)</sup> Input Impedance is in paralleled with capacitance <120pF.

- Maximum input voltage: 1000Vdc or peak ac on any range
- Response Time: Approximately 1.0 second when the displayed reading reaches 99.9% dc value of the tested input signal at the same range.

*Note: When voltage (ac+dc) measurement function is selected, the Vdc input impedance is paralleled with an ac-coupled 1.1M $\Omega$  ac divider.*

### Noise Rejection Ratio

Rate	CMRR <sup>(1)</sup>	NMRR <sup>(2)</sup>
S / M / F	>90dB at dc, 50/60Hz $\pm$ 0.1% (1k $\Omega$ Unbalanced)	>50dB at 50/60Hz $\pm$ 0.1%

<sup>(1)</sup> CMRR is the Common Mode Reject Ratio

<sup>(2)</sup> NMRR is the Normal Mode Rejection Ratio

● AC Voltage (True RMS, AC Coupling Mode)

**Resolution and Full Scale Reading**

Range		Resolution			Full Scale Reading		
S	M & F	S	M	F	S	M	F
120mV	400mV	1μV	10μV	100μV	119.999	399.99	399.9
1.2V	4V	10μV	100μV	1mV	1.19999	3.9999	3.999
12V	40V	100μV	1mV	10mV	11.9999	39.999	39.99
120V	400V	1mV	10mV	100mV	119.999	399.99	399.9
750V	750V	10mV	100mV	1V	750.00 <sup>(1)</sup>	750.0 <sup>(1)</sup>	750 <sup>(1)</sup>

<sup>(1)</sup> In Vac 750V range, 5% over-range (787.5V rms) is readable

**Accuracy**

Rate	Range	Accuracy (1 year) <sup>(1)</sup>		
		40 to 50 Hz	50 to 5k Hz	5 to 30 kHz
S	120.000mV	2% + 200	1.5% + 200	3% + 300
	1.20000V	2% + 200	1.5% + 200	3% + 300
	12.0000V	2% + 200	1.5% + 200	3% + 300
	120.000V	2% + 200	1.5% + 200	3% + 300
	750.00V	2% + 200	1.5% + 200	3% + 300 <sup>(2)</sup>
M	400.00mV	2% + 80	1.5% + 80	3% + 100
	4.0000V	2% + 80	1.5% + 80	3% + 100
	40.000V	2% + 80	1.5% + 80	3% + 100
	400.00V	2% + 80	1.5% + 80	3% + 100 <sup>(2)</sup>
	750.0V	2% + 80	1.5% + 80	3% + 100 <sup>(2)</sup>
F	400.0mV	2% + 10	1.5% + 10	3% + 12
	4.000V	2% + 10	1.5% + 10	3% + 12
	40.00V	2% + 10	1.5% + 10	3% + 12
	400.0V	2% + 10	1.5% + 10	3% + 12 <sup>(2)</sup>
	750V	2% + 10	1.5% + 10	3% + 12 <sup>(2)</sup>

<sup>(1)</sup> Specified accuracy at input >5% of full scale  
<sup>(2)</sup> Specified accuracy for input voltage at frequency <20kHz

- Measurement method: True RMS
- Maximum Crest Factor: 3.0 at full scale
- Maximum input voltage: 750V rms, 1100V peak ac
  - 2x10<sup>7</sup> V-Hz product on any range, normal mode input
  - 1x10<sup>6</sup> V-Hz product on any range, common mode input
- Input Impedance: 1MΩ in parallel with capacitance <120pF
- Response Time: Approximately 1.5 seconds when the displayed reading reaches 99.9% ac rms value of the tested input signal at the same range.

- AC Voltage (True RMS, AC+DC Coupling Mode)

### Resolution and Full Scale Reading

Range <sup>(1)</sup>		Resolution			Full Scale Reading		
S	M & F	S	M	F	S	M	F
120mV	400mV	1μV	10μV	100μV	119.999	399.99	399.9
1.2V	4V	10μV	100μV	1mV	1.19999	3.9999	3.999
12V	40V	100μV	1mV	10mV	11.9999	39.999	39.99
120V	400V	1mV	10mV	100mV	119.999	399.99	399.9
750V	750V	10mV	100mV	1V	750.00 <sup>(2)</sup>	750.0 <sup>(2)</sup>	750 <sup>(2)</sup>

<sup>(1)</sup> Vdc and Vac are automatically set at the same range  
<sup>(2)</sup> In Vac 750V range, 5% over-range (787.5V rms) is readable

### Accuracy

Rate	Range	Accuracy (1 year) <sup>(1)</sup>	
		50 to 5 kHz	5 to 30 kHz
S	120.000mV	1.5% + 200	3% + 300
	1.20000V	1.5% + 200	3% + 300
	12.0000V	1.5% + 200	3% + 300
	120.000V	1.5% + 200	3% + 300
	750.00V	1.5% + 200	3% + 300 <sup>(2)</sup>
M	400.00mV	1.5% + 82	3% + 100
	4.0000V	1.5% + 82	3% + 100
	40.000V	1.5% + 82	3% + 100
	400.00V	1.5% + 82	3% + 100 <sup>(2)</sup>
	750.0V	1.5% + 82	3% + 100 <sup>(2)</sup>
F	400.0mV	1.5% + 12	3% + 15
	4.000V	1.5% + 12	3% + 15
	40.00V	1.5% + 12	3% + 15
	400.0V	1.5% + 12	3% + 15 <sup>(2)</sup>
	750V	1.5% + 12	3% + 15 <sup>(2)</sup>

<sup>(1)</sup> Specified accuracy at input >5% of full scale  
<sup>(2)</sup> Specified accuracy for input voltage at frequency <20kHz

- Measurement method: True RMS AC+DC
- Maximum Crest Factor: 3.0 at full scale
- Maximum input voltage: 750V rms, 1100V peak ac
  - 2x10<sup>7</sup> V-Hz product on any range, normal mode input
  - 1x10<sup>6</sup> V-Hz product on any range, common mode input
- Input Impedance: 1MΩ in parallel with capacitance <120pF
- Response Time: Approximately 2.5 seconds when the displayed reading reaches 99.9% (ac+dc) rms value of the tested input signal at the same range.

- DC Current

Rate	Range	Resolution	Full Scale Reading	Accuracy (1 year)	Burden Voltage <sup>(1)</sup> & Shunt Resistor
S	12mA	0.1μA	11.9999	0.1% + 20 <sup>(2)</sup>	<0.15V / 10Ω
	120mA	1μA	119.999	0.1% + 8	<1.5V / 10Ω
	12A	100μA	11.9999	0.5% + 8	<0.6V / 0.01Ω
M	40mA	1μA	39.999	0.2% + 8	<0.5V / 10Ω
	120mA	10μA	119.99	0.2% + 3	<1.5V / 10Ω
	12A	1mA	11.999	0.5% + 3	<0.6V / 0.01Ω
F	40mA	10μA	39.99	0.2% + 2	<0.5V / 10Ω
	120mA	100μA	119.9	0.2% + 2	<1.5V / 10Ω
	12A	10mA	11.99	0.5% + 2	<0.6V / 0.01Ω

<sup>(1)</sup> Typical at full scale reading and voltage across the input terminals

<sup>(2)</sup> Use relative (REL) modifier

- **Maximum Input and Overload Current Protection (for dc and ac current):**  
 mA Input Terminal: 1200mA dc or ac rms and protected with 2A/250V, IEC-127 sheet 1 fast blow fuse;  
 12A input terminal: 10A dc or ac rms continuous, or 12A dc or ac rms for 30 seconds maximum and protected with 15A/500V, breaking capacity 10,000A fast blow fuse.
- **Response Time:** Approximately 1.0 second when the displayed reading reaches 99.9% dc value of the tested input signal at the same range.

- AC Current (True RMS, AC Coupling Mode)

### Resolution, Full Scale Reading and Burden Voltage

Rate	Range	Resolution	Full Scale Reading	Burden Voltage <sup>(1)</sup> & Shunt Resistor
S	12mA	0.1μA	11.9999	<0.15V / 10Ω
	120mA	1μA	119.999	<1.5V / 10Ω
	12A	100μA	11.9999	<0.6V / 0.01Ω
M	40mA	1μA	39.999	<0.5V / 10Ω
	120mA	10μA	119.99	<1.5V / 10Ω
	12A	1mA	11.999	<0.6V / 0.01Ω
F	40mA	10μA	39.99	<0.5V / 10Ω
	120mA	100μA	119.9	<1.5V / 10Ω
	12A	10mA	11.99	<0.6V / 0.01Ω

<sup>(1)</sup> Typical at full scale reading and rms voltage across the input terminals

### Accuracy

Rate	Range	Accuracy (1 year) <sup>(1)</sup>		
		40 to 50 Hz	50 to 2k Hz	2 to 5 kHz
S	12mA	2.5% + 200	1.5% + 200	3% + 200
	120mA	2.5% + 200	1.5% + 200	3% + 200
	12A	3% + 300	3% + 200	-
M	40mA	2.5% + 80	1.5% + 80	3% + 80
	120mA	2.5% + 30	1.5% + 30	3% + 30
	12A	3% + 30	3% + 30	-
F	40mA	2.5% + 10	1.5% + 10	3% + 10
	120mA	2.5% + 5	1.5% + 5	3% + 5
	12A	3% + 5	3% + 5	-

<sup>(1)</sup> Specified accuracy at input >5% of full scale

- Measurement method: True RMS
- Maximum Crest Factor: 3.0 at full scale
- Response Time: Approximately 1.5 seconds when the displayed reading reaches 99.9% ac rms value of the tested input signal at the same range.

- AC Current (True RMS, AC+DC Coupling Mode)

### Resolution, Full Scale Reading and Burden Voltage

Rate	Range	Resolution	Full Scale Reading	Burden Voltage <sup>(1)</sup> & Shunt Resistor
S	12mA	0.1μA	11.9999	<0.15V / 10Ω
	120mA	1μA	119.999	<1.5V / 10Ω
	12A	100μA	11.9999	<0.6V / 0.01Ω
M	40mA	1μA	39.999	<0.5V / 10Ω
	120mA	10μA	119.99	<1.5V / 10Ω
	12A	1mA	11.999	<0.6V / 0.01Ω
F	40mA	10μA	39.99	<0.5V / 10Ω
	120mA	100μA	119.9	<1.5V / 10Ω
	12A	10mA	11.99	<0.6V / 0.01Ω

<sup>(1)</sup> Typical at full scale reading and rms voltage across the input terminals

### Accuracy

Rate	Range	Accuracy (1 year) <sup>(1)</sup>	
		50 to 2k Hz	2 to 5 kHz
S	12mA	1.5% + 200	3% + 200
	120mA	1.5% + 200	3% + 200
	12A	3% + 200	-
M	40mA	1.5% + 82	3% + 82
	120mA	1.5% + 32	3% + 32
	12A	3% + 32	-
F	40mA	1.5% + 12	3% + 12
	120mA	1.5% + 7	3% + 7
	12A	3% + 7	-

<sup>(1)</sup> Specified accuracy at input >5% of full scale

- Measurement range: Vdc and Vac are automatically set at the same range
- Measurement method: True RMS AC+DC
- Maximum Crest Factor: 3.0 at full scale
- Response Time: Approximately 2.5 seconds when the displayed reading reaches 99.9% (ac+dc) rms value of the tested input signal at the same range.

- Resistance (2-wire  $\Omega$  and 4-wire  $\Omega$ )

Rate	Range <sup>(1)</sup>	Resolution	Full Scale Reading	Test Current	Accuracy (1 year)	
					2-wire	4-wire
S	120 $\Omega$	1m $\Omega$	119.999	0.5mA	0.15% + 8 <sup>(2)</sup>	0.1% + 8 <sup>(2)</sup>
	1.2k $\Omega$	10m $\Omega$	1.19999	0.5mA	0.12% + 5 <sup>(2)</sup>	0.1% + 5 <sup>(2)</sup>
	12k $\Omega$	100m $\Omega$	11.9999	100 $\mu$ A	0.12% + 5 <sup>(2)</sup>	0.1% + 5
	120k $\Omega$	1 $\Omega$	119.999	10 $\mu$ A	0.12% + 5	0.15% + 5
	1.2M $\Omega$	10 $\Omega$	1.19999	1 $\mu$ A	0.12% + 5	0.1% + 5
	12M $\Omega$	100 $\Omega$	11.9999	100nA	0.5% + 5	0.5% + 5
	120M $\Omega$	1k $\Omega$	119.999	10nA	3.5% + 8	3.5% + 8
M	400 $\Omega$	10m $\Omega$	399.99	0.5mA	0.15% + 5 <sup>(2)</sup>	0.1% + 5 <sup>(2)</sup>
	4k $\Omega$	100m $\Omega$	3.9999	100 $\mu$ A	0.12% + 3 <sup>(2)</sup>	0.1% + 3
	40k $\Omega$	1 $\Omega$	39.999	50 $\mu$ A	0.12% + 3	0.1% + 3
	400k $\Omega$	10 $\Omega$	399.99	5 $\mu$ A	0.12% + 3	0.1% + 3
	4M $\Omega$	100 $\Omega$	3.9999	500nA	0.2% + 3	0.2% + 3
	40M $\Omega$	1k $\Omega$	39.999	50nA	1.5% + 3	1.5% + 3
	300M $\Omega$	10k $\Omega$	299.99	10nA	5.0% + 5	5.0% + 5
F	400 $\Omega$	100m $\Omega$	399.9	0.5mA	0.15% + 2 <sup>(2)</sup>	0.1% + 2
	4k $\Omega$	1 $\Omega$	3.999	100 $\mu$ A	0.12% + 2	0.1% + 2
	40k $\Omega$	10 $\Omega$	39.99	50 $\mu$ A	0.12% + 2	0.1% + 2
	400k $\Omega$	100 $\Omega$	399.9	5 $\mu$ A	0.12% + 2	0.1% + 2
	4M $\Omega$	1k $\Omega$	3.999	500nA	0.2% + 2	0.2% + 2
	40M $\Omega$	10k $\Omega$	39.99	50nA	1.5% + 2	1.5% + 2
	300M $\Omega$	100k $\Omega$	299.9	10nA	5.0% + 2	5.0% + 2

<sup>(1)</sup> In order to eliminate the noise interference, which might be induced to the test leads, it is recommended to use a shielded test cable for measuring resistance above 120K $\Omega$ .

<sup>(2)</sup> Use relative (REL) modifier.

- Open Circuit Voltage: < +5.0V dc
- Zeroing error: 0.05 $\Omega$  or less (excluding test lead resistances) in each range when REL modifier is used
- Response time: Approximately 1.5 seconds for 12M $\Omega$  and ranges below 12M $\Omega$ ; approximately 5 seconds for 40M $\Omega$  range; approximately 10 seconds for 120M $\Omega$ ; approximately 25 seconds for 300M $\Omega$  range.
- Maximum Input Protection: 500V dc or ac rms



- **Diode Test/Continuity**

Rate	Maximum Reading	Resolution
S	1.19999V	10 $\mu$ V
M	2.4999V	100 $\mu$ V
F	2.499V	1mV

- **Open Circuit Voltage:** < +5.0V dc
- **Test Current:** Approximately 0.5mA dc
- **Audible Tone:** Continuous beep for continuity and single tone for normal forward-biased diode or semiconductor junction
- **Continuity level:** Approximately below +50mV dc
- **Maximum Input Protection:** 500V dc or ac rms

- **Resistance/Continuity (2-wire)**

Rate	Range	Resolution	Maximum Reading	Accuracy
S	120 $\Omega$	1m $\Omega$	119.999	0.15% + 8 <sup>(1)</sup>
M	400 $\Omega$	10m $\Omega$	399.99	0.15% + 5 <sup>(1)</sup>
F	400 $\Omega$	100m $\Omega$	399.9	0.15% + 2 <sup>(1)</sup>
<sup>(1)</sup> Use relative (REL) modifier				

- **Open Circuit Voltage:** < +5.0V dc
- **Test Current:** Approximately 0.5mA
- **Audible Tone:** Continuous beep for reading is less than 10 $\Omega$
- **Zeroing error:** 0.05 $\Omega$  or less (excluding test lead resistances) in each range when REL modifier is used
- **Maximum Input Protection:** 500V dc or ac rms

- **Frequency**

**Resolution, Full Scale Reading and Accuracy**

Range (Hz)	Measurement Range (Hz)	Resolution (Hz)	Full Scale Reading	Accuracy (1 year) <sup>(1)</sup>	Input Sensitivity (Sine wave)
1200	5 to 1200	10m	1199.99	0.01 + 5	50mV rms
12k	10 to 12k	100m	11.9999	0.01 + 3	
120k	100 to 120k	1	119.999	0.01 + 3	
<sup>(1)</sup> Specified accuracy at input >5% of full scale <sup>(2)</sup> If tested frequency is greater than 1MHz, it will be displayed but no specified accuracy is guaranteed.					

- **Measurement method: True RMS**
- **Maximum Crest Factor: 3.0 at full scale**
- **Maximum input voltage: 750V rms, 1100V peak ac**
  - $2 \times 10^7$  V-Hz product on any range, normal mode input
  - $1 \times 10^6$  V-Hz product on any range, common mode input
- **Input Impedance: 1MΩ in parallel with capacitance <120pF**
- **Response Time: Approximately 1.2 seconds when the displayed reading reaches 99.9% frequency value of the tested input signal at the same range.**

- dBm (decibel calculation)

### Reference Impedance <sup>(1)</sup>

2Ω <sup>(2)</sup>	50Ω	135Ω	800Ω
4Ω <sup>(2)</sup>	75Ω	150Ω	900Ω
8Ω <sup>(2)</sup>	93Ω	250Ω	1000Ω
16Ω <sup>(2)</sup>	110Ω	300Ω	1200Ω
	124Ω	500Ω	8000Ω
	125Ω	600Ω <sup>(3)</sup>	

(1) Reference impedance is displayed on the secondary display  
 (2) Reading displayed in watts (Audio Power)  
 (3) Default reference impedance

### Range and Accuracy

Rate	Voltage Range <sup>(1,2)</sup>	Input Voltage	dBm <sup>(3)</sup> Range @ 600Ω Ref	Accuracy (dB)		
				40 to 50 Hz	50 to 5k Hz	5 to 30 kHz
S	120mV	6mV ~ 120mV	-42.20 ~ -16.20	1.0	1.0	1.0
	1.2V	120mV ~ 1.2V	-16.20 ~ 3.80	0.8	0.6	0.8
	12V	1.2V ~ 12V	3.80 ~ 23.80	0.8	0.6	0.8
	120V	12V ~ 120V	23.80 ~ 43.80	0.8	0.6	0.8
	1000V (dc) 750V (ac)	120V ~ 1000V 120V ~ 750V	43.80 ~ 62.22 43.80 ~ 59.72	-	1.0 <sup>(4)</sup>	-
M & F	400mV	20mV ~ 400mV	-31.76 ~ -5.74	1.0	1.0	1.0
	4V	400mV ~ 4V	-5.74 ~ 14.26	0.8	0.6	0.8
	40V	4V ~ 40V	14.26 ~ 34.26	0.8	0.6	0.8
	400V	40V ~ 400V	34.26 ~ 54.26	0.8	0.6	0.8
	1000V (dc) 750V (ac)	400V ~ 1000V 400V ~ 750V	54.26 ~ 62.22 54.26 ~ 59.72	-	1.0 <sup>(4)</sup>	-

(1) Auto-ranging is used when dBm function is selected  
 (2) In Vac 750V range, 5% over-range is readable  
 (3) Reading displayed in dB when REL modifier is used  
 (4) For input voltage at frequency between 45Hz to 1kHz

- 0dBm: 1 mW @ 600Ω Reference Impedance.
- Resolution: 0.01dB at slow and medium rate; 0.1dB at fast rate for all ranges.
- CMRR: > 90dB for dc signal
- Response Time: Same as ac voltage and ac current measurements.

## B-3 General Specifications

General Items	Specifications
Warm up time	At least 30 minutes
Temperature Coefficient	Add 0.15 x (the applicable accuracy)/°C at 0°C to 18°C and 28°C to 50°C
Operating Temperature	0°C to 50°C (32°F to 122°F)
Storage Temperature	-20°C to 60°C
Altitude	Up to 2000 M
Pollution Degree	II
Over-voltage Category	CAT II-600V and CAT I-1000V
Relative Humidity	<ul style="list-style-type: none"> <li>• Up to 80% for 0°C to 28°C (75% RH for 12MΩ and above ranges of resistance measurement)</li> <li>• Up to 70% for 28°C to 35°C</li> <li>• Up to 50% for 35°C to 50°C</li> </ul>
Common Mode Voltage	1000V dc or peak ac rms maximum between any input and earth ground
Dimension	Approx. 255(w) x 105(h) x 305(d) mm (with holsters)
Weight	<3.0kgs
Line Voltage	100V / 120V / 220V / 240V ac ±10%, 50/60Hz, 16VA maximum
Interface	RS-232 (DB-9, male connector) <ul style="list-style-type: none"> <li>• Baud rates: 9600, 4800, 2400, 1200, 600, 300</li> <li>• Data length: 7 or 8 bits</li> <li>• Parity: even / odd / none</li> <li>• Stop bit: 1 or 2 bits</li> <li>• Echo: on / off</li> <li>• Print mode: on / off</li> </ul>
Safety Requirement	Designed in compliance with EN61010-1 (IEC1010-1)
Installation Category	CAT-I 750VAC/1000VDC or CAT-II 600V, Pollution Degree 2 Environment
EMC Requirement	Designed in compliance with EN61326-1.

# Appendix C

## Maintenance

### C-1 Introduction

Appendix C describes the basic maintenance procedures to the 5 1/2 Digit Dual Display Multimeter.

 **WARNING!**

*To avoid electrical shock or damaging the meter, never get water inside the case.*

### C-2 Cleaning the Meter

Before cleaning the meters, make sure the power is switched in OFF position and the power cord is disconnected from the AC outlet. To clean the meter, wipe the dirty parts with gauze or soft cloth soaked with diluted neutral detergent. Do not get too wet to prevent the detergent from penetrating into inside parts and causing damages. After cleaning, leave the instrument until it dries completely.

### C-3 Configure the Line Voltage

 **Caution!**

Before setting the line voltage selector, the main power should be turned off and remove Power cord from the meter. This meter operates on a 100V, 120V, 220V or 240V AC, 50/60Hz line voltage source.

Extract the fuse drawer from the AC socket with the aid of a screwdriver to move the fuse holder with the voltage selector from the fuse holder.

Pull out the fuse link from the fuse holder with the voltage selector. Replace a new fuse with a rated voltage in accordance with specific required line voltage. Select the voltage according to users Local line voltage.

If the line voltage used is 230V, be sure to switch the line voltage selection to 240V.

## C-4 Accessories and Replacement Parts

### Standard Accessories (supplied):

Model	Description
	Power Cord
TL 36	Test Leads (Red and Black)
AC 01	Cap for TL 36 (2pcs)
481-408-9-001	Operation manual
198-304-9-001	Fuse, 2A/250V Fast Blow 6 x 31mm (For 5492 only)
198-305-9-001	Fuse, 250mA/250V Fast Blow 6 x 31mm (For 5491 only)

### Optional Accessories:

Model	Description
AK 5491	RS232 cable
	PC Link software.
TL 35	Test leads (Red and Black)
AC 02	Lantern tip extension probe for TL 35
KC 01	4 Wires test cable set with Kelvin clips
AC 03	Alligator clip, Red
	Alligator clip, Black
RK 01	Rack mount kit for single meter
TH 02	Insulation piercing clip
198-306-9-001	Fuse 15A/500V Fast Blow 10.3 x 38.1mm