

Vertical RJ45 1000 Base-T Single Port, w/ LEDs, Extended Temperature

ARJ-148

RoHS/RoHS II Compliant



16.9 x 15.9 x 23.2mm

FEATURES:

- Compliant with IEEE802.3 standard
- Designed for Network Interface Cards(NIC), LAN-on-Motherboard(LOM) and PC applications Ethernet Switch, Servers, & Access Point Routers
- High performance for maximum EMI suppression
- 350μH minimum OCL with 8mA bias current
- RoHS peak wave solder temperature 260°C

APPLICATIONS:

- Support 1000 Base-T applications w/ Bi-Color LEDs
- Vertical Mount with wide temperature range(-40°C~85°C)
- Applicable for Ethernet Switch, Servers, & Access Point Routers
- Provides signal conditioning, EMI suppression and signal isolation

STANDARD SPECIFICATIONS

| Parameters | Minimum | Typical | Maximum | Units | Notes |
|-----------------------|-------------------|---------|---------|-------|-----------------|
| Operating Temperature | -40 | | +85 | °C | |
| Storage Temperature | -40 | | +85 | °C | |
| Turn Ratio (± 3%) | 1CT:1CT | | | | Tx |
| | 1CT:1CT | | | | Rx |
| Inductance (OCL) | 350 | | | μH | 100KHz/0.1V@8mA |
| Insertion Loss | | | -1.0 | dB | 1-100MHz |
| Return Loss | -18 | | | dB | 1-10MHz |
| | -16 | | | | 10-30MHz |
| | -14 | | | | 30-60MHz |
| | -12 | | | | 60-80MHz |
| | -10 | | | | 80-100MHz |
| Cross Talk | -35 | | | dB | 1-100MHz |
| CMR | -35 | | | dB | 1-100MHz |
| Hi-Pot | 1500Vrms/1mA/1Sec | | | | Pri to Sec |

SCHEMATICS

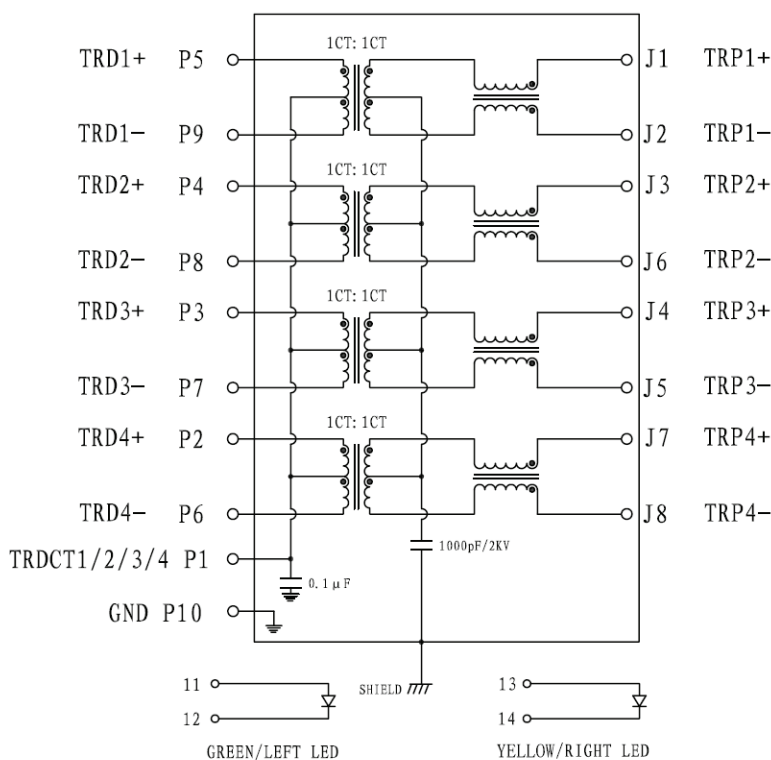

ABRACON IS
ISO 9001:2008
CERTIFIED

ABRACON[®]
The Power of Linking Together

2 Faraday, Suite# B | Irvine | CA 92618 Revised: 07.23.15
Ph. 949.546.8000 | Fax. 949.546.8001

Visit www.abracon.com for Terms and Conditions of Sale

Vertical RJ45 1000 Base-T Single Port, w/ LEDs, Extended Temperature

ARJ-148

RoHS/RoHS II Compliant



16.9 x 15.9 x 23.2mm

MECHANICAL DIMENSIONS

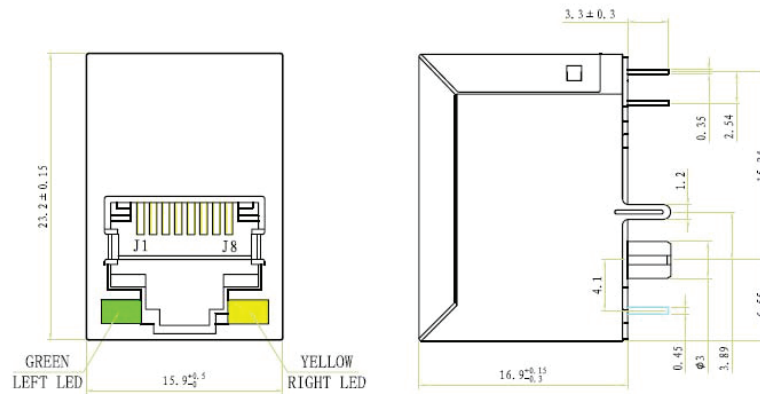

Recommended Land Pattern

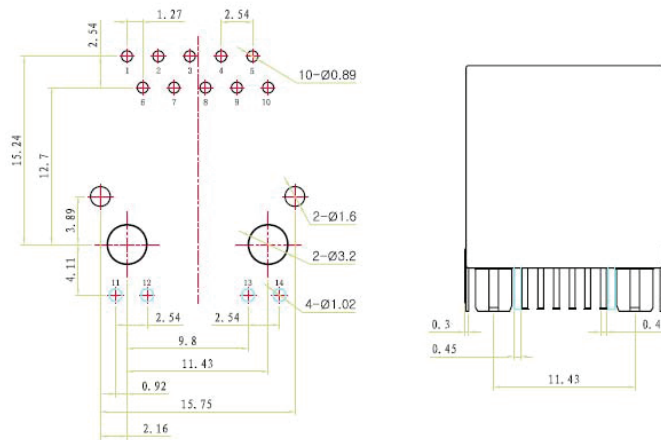

Dimensions: mm

DIP WAVE SOLDERING PROFILE

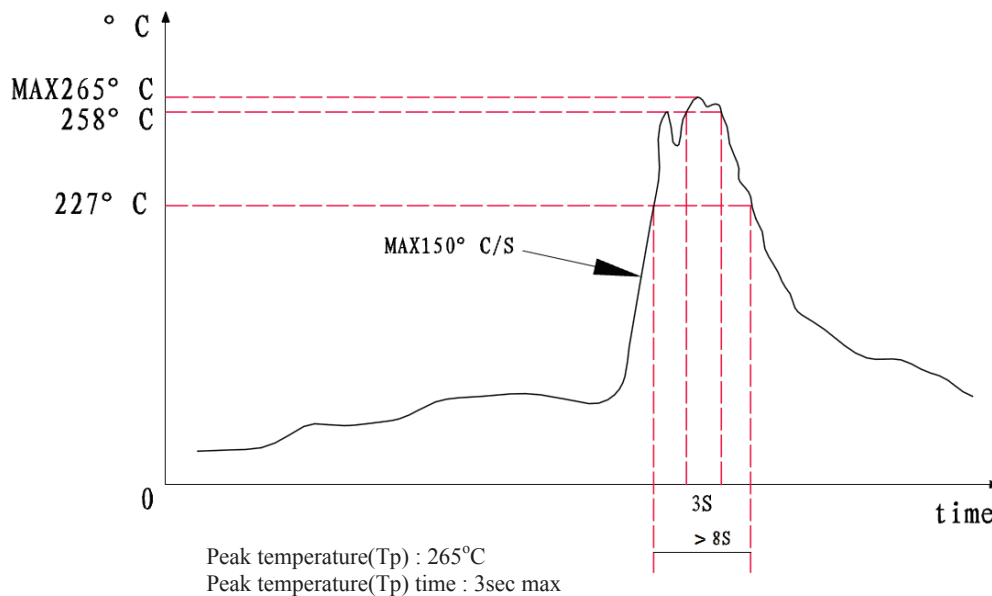

Vertical RJ45 1000 Base-T Single Port, w/ LEDs, Extended Temperature

ARJ-148

RoHS/RoHS II Compliant



16.9 x 15.9 x 23.2mm

PACKAGING:

Packing: 200pcs/tray
Weight: 7.19 grams / pcs

Packing Material: PC Plastic

1. Inner Package: L=320mm; W=320mm; H=20mm;
2. There are 12 slot grids on the tray and There are 15Pcs In the two terminal slot grids, there are 17PCS in 12 middle slot grids.
3. Paste ROHS label and barcode label.
4. Material: PC Plastic.

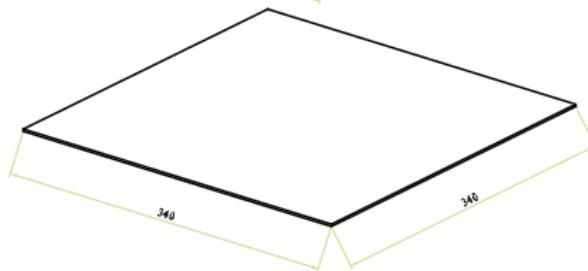
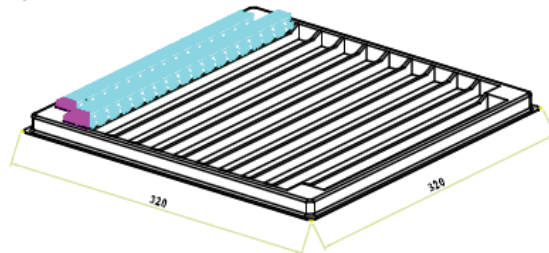
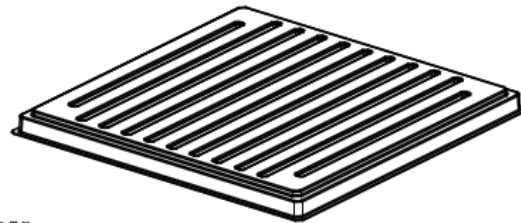
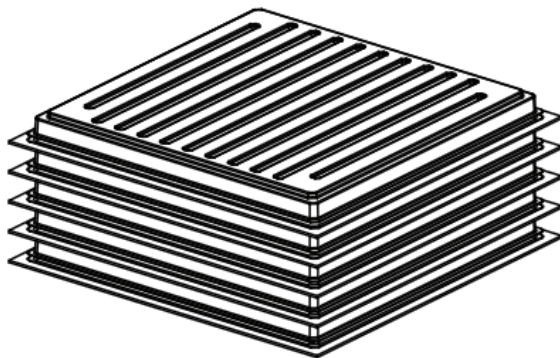

Outer carton unit (optional): 1000 pcs/5 trays/box

1. Package Box : L=350mm; W=350mm; H=185mm;
2. Package Box contain 5 PCS inner package Trays.
3. Material: US CARD+kraft papers.
4. There are 1000PCS products in the Package Box.

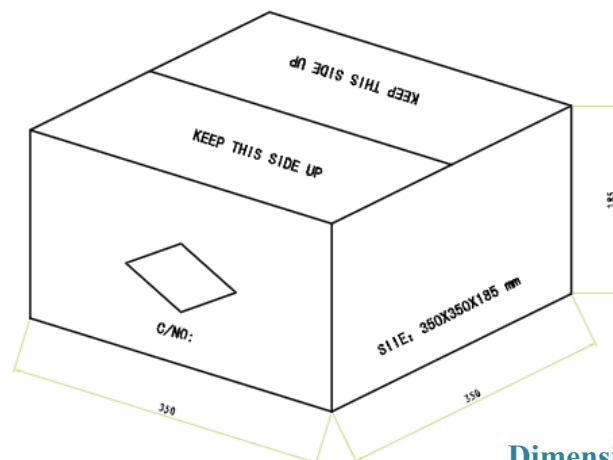

Dimensions: cm

ATTENTION: Abracon Corporation's products are COTS – Commercial-Off-The-Shelf products; suitable for Commercial, Industrial and, where designated, Automotive Applications. Abracon's products are not specifically designed for Military, Aviation, Aerospace, Life-dependant Medical applications or any application requiring high reliability where component failure could result in loss of life and/or property. For applications requiring high reliability and/or presenting an extreme operating environment, written consent and authorization from Abracon Corporation is required. Please contact Abracon Corporation for more information.

ABRACON IS
ISO 9001:2008
CERTIFIED



2 Faraday, Suite# B | Irvine | CA 92618 **Revised: 07.23.15**

Ph. 949.546.8000 | Fax. 949.546.8001

Visit www.abracon.com for Terms and Conditions of Sale