

80mΩ, 3A Smart Universal Power Switch with Flag

General Description

The RT9703 is a low voltage, high performance single N-MOSFET power switch, designed for power rail on/off control with low $R_{DS(ON)} \approx 80m\Omega$ and full protection functions. The RT9703 equipped with a charge pump circuitry to drive the internal MOSFET switch and a flag output is available to indicate fault conditions against large di/dt which may cause the supply to fall out of regulation. In order to fit different application, an IP pin is offered for current limit point setting, a resistor from IP to ground sets the current limit for the switch.

Additional features include soft-start to limit inrush current during plug-in, thermal shutdown to prevent catastrophic switch failure from high-current loads, under-voltage lockout (UVLO) to ensure that the device remains off unless there is a valid input voltage present, a precision resistor-programmable output current limit up to 3.5A. Besides, the lower quiescent current as 30μA making this device ideal for portable battery-operated equipment.

The RT9703 is available in SOP-8 package requiring minimum board space and smallest components.

Ordering Information

RT9703 □ □

- Package Type
S : SOP-8
- Lead Plating System
P : Pb Free
G : Green (Halogen Free and Pb Free)

Note :

Richtek products are :

- ▶ RoHS compliant and compatible with the current requirements of IPC/JEDEC J-STD-020.
- ▶ Suitable for use in SnPb or Pb-free soldering processes.

Features

- Adjustable Current Limiting up to 3.5A
- Built-In (Typically 80mΩ) N-MOSFET
- Reverse Current Flow Blocking (no body diode) i.e. Output Can Be Forced Higher than Input (Off-State)
- Low Supply Current :
 - ▶ 30μA Typical at Switch on State
 - ▶ Less than 1μA Typical at Switch Off State
- Guaranteed 3A Continuous Load Current
- Wide Input Voltage Ranges : 2V to 5.5V
- Open-Drain Fault Flag Output
- Hot Plug-In Application (Soft-Start)
- 1.7V Typical Under-Voltage Lockout (UVLO)
- Thermal Shutdown Protection
- Smallest SOP-8 Package Minimizes Board Space
- RoHS Compliant and 100% Lead (Pb)-Free

Applications

- LCD Monitor, LCD-TV
- USB Power Module for ADSL
- Information Appliance and Set-Top Box
- Battery-Powered Equipment
- Hot-Plug Power Supplies
- ACPI Power Distribution
- PCI Bus Power Switching
- Motherboard & Notebook PCs
- PC Card Hot Swap Application

Pin Configurations

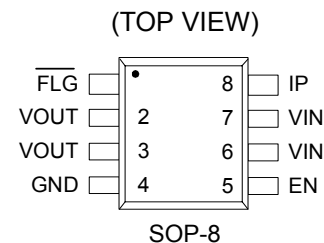

Typical Application Circuit

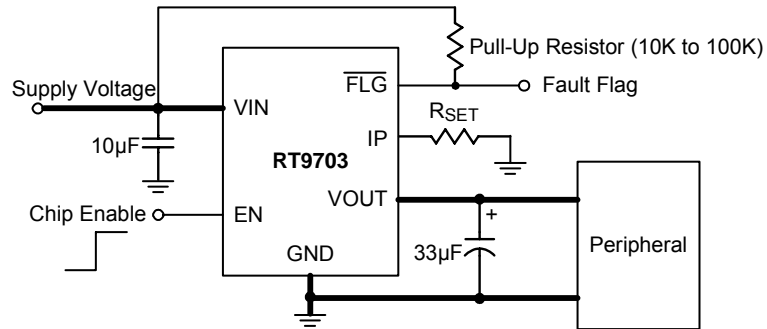

Functional Pin Description

Pin Name	Pin Function
VIN	Power-Input Voltage.
VOUT	Output Voltage.
GND	Ground.
EN	Chip Enable (Active High).
FLG	Open-Drain Fault Flag Output.
IP	Current Limit Programming Input.

Function Block Diagram

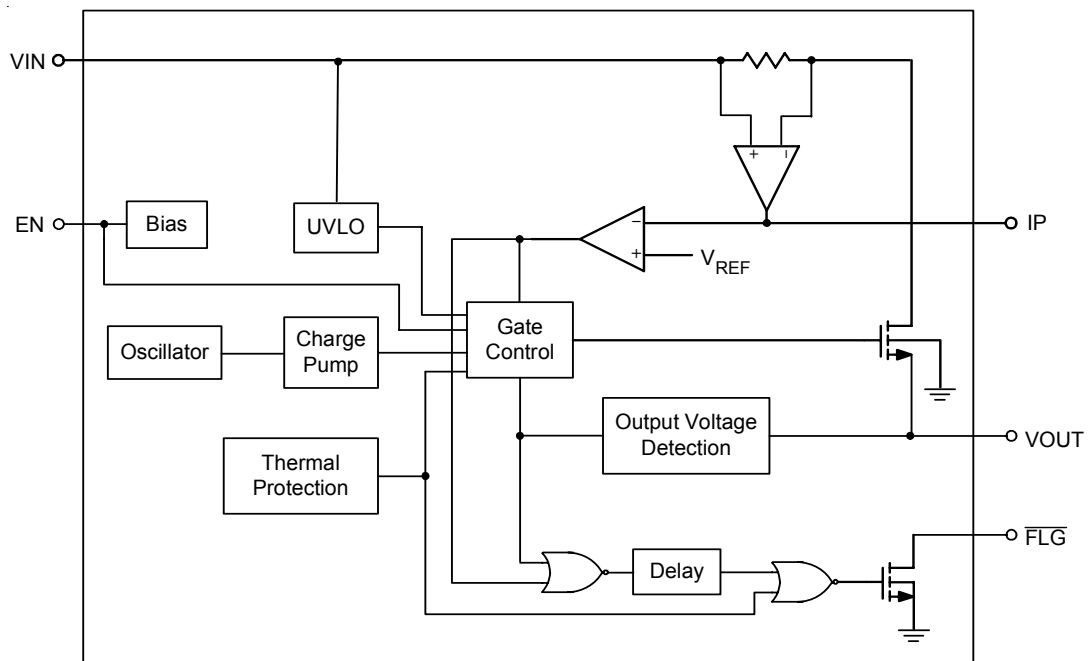

Test Circuits

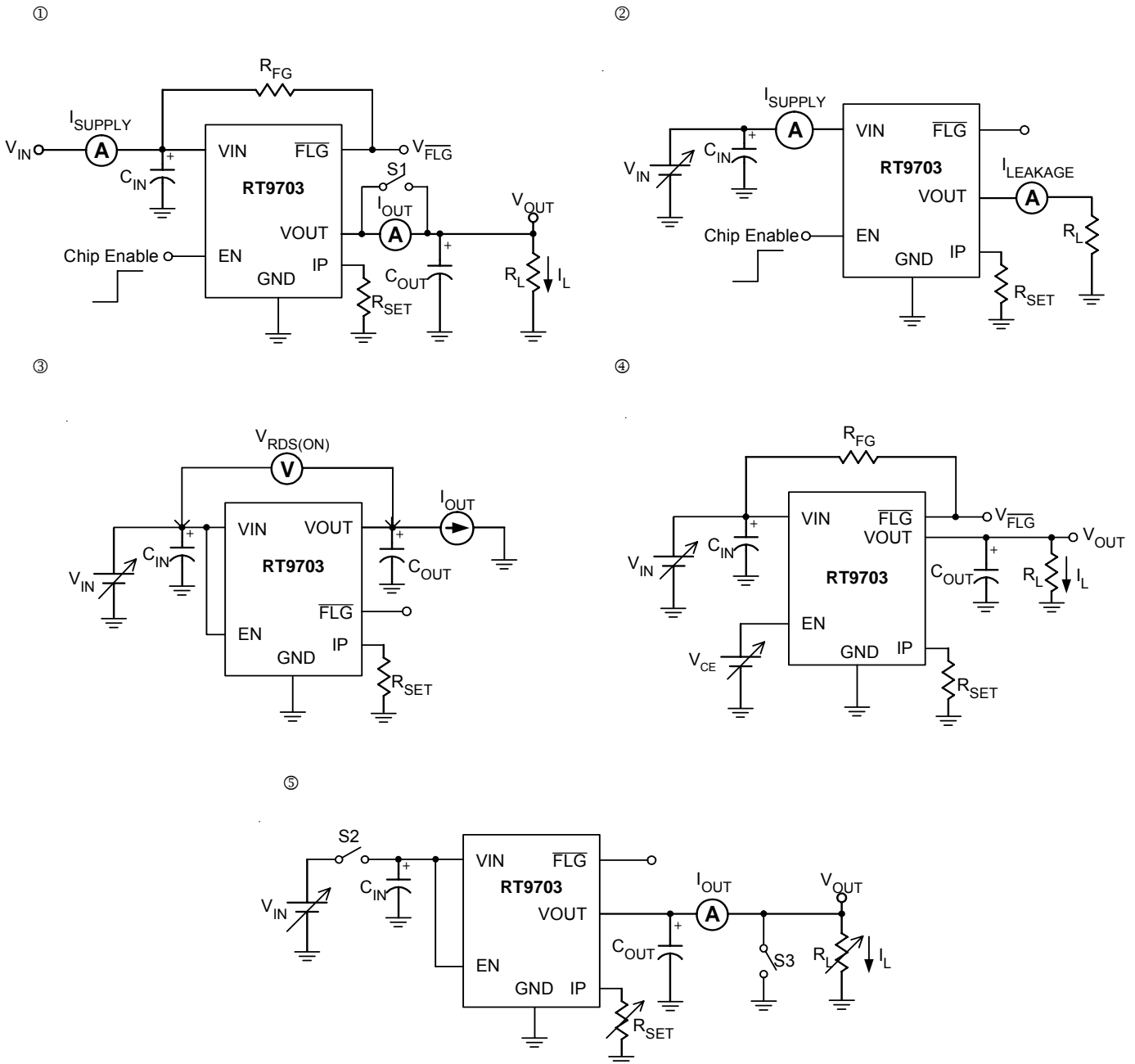

Note: Above test circuits reflected the graphs shown on "Typical Operating Characteristics" are as follows:

- ①—Turn-On Rising & Turn-Off Falling Time vs. Temperature, Turn-On & Off Response, Flag Response at Chip Enable, Flag Response (Enable into Current Limit)
- ②—On-State & Off-State Supply Current vs. Input Voltage/Temperature, Turn-Off Leakage Current vs. Temperature
- ③—On-Resistance vs. Input Voltage/Temperature
- ④—EN Threshold Voltage vs. Input Voltage/Temperature, Flag Delay Time vs. Input Voltage/Temperature, UVLO Threshold vs. Temperature, UVLO at Rising & Falling
- ⑤—Current Limit vs. Input Voltage/Temperature/ R_{SET} , Current Limit Factor vs. R_{SET} , Short Circuit Current vs. Input Voltage, Inrush Current Response, Soft-Start Response, Current-Limit & Short Circuit with Thermal Shutdown, Short-Circuit Response

Absolute Maximum Ratings (Note 1)

- Supply Voltage ----- 6.5V
- Chip Enable Input Voltage ----- -0.3V to 6.5V
- Flag Voltage ----- 6.5V
- Power Dissipation, $P_D @ T_A = 25^\circ\text{C}$
- SOP-8 ----- 0.95W
- Package Thermal Resistance
- SOP-8, θ_{JA} ----- 104°C/W
- Junction Temperature ----- 125°C
- Lead Temperature (Soldering, 10 sec.) ----- 260°C
- Storage Temperature Range ----- -65°C to 150°C
- ESD Susceptibility (Note 2)
- HBM (Human Body Mode) ----- 8kV
- MM (Machine Mode) ----- 800V

Recommended Operating Conditions (Note 3)

- Supply Input Voltage ----- 2V to 5.5V
- Chip Enable Input Voltage ----- 0V to 5.5V
- Junction Temperature Range ----- -20°C to 100°C

Electrical Characteristics

($V_{IN} = 5V$, $C_{IN} = C_{OUT} = 1\mu\text{F}$, $T_A = 25^\circ\text{C}$, unless otherwise specified)

Parameter		Symbol	Test Conditions	Min	Typ	Max	Unit
Switch On Resistance		$R_{DS(ON)}$	$I_{OUT} = 3A$ (Note 8)	--	80	100	mΩ
Supply Current		I_{SW_ON}	Switch On, $V_{OUT} = \text{Open}$	--	30	50	μA
		I_{SW_OFF}	Switch Off, $V_{OUT} = \text{Open}$	--	0.1	1	
CE Threshold (Note 7)	Logic-Low Voltage	V_{IL}	Switch Off	--	--	0.8	V
	Logic-High Voltage	V_{IH}	Switch On	2.0	--	--	V
CE Input Current		I_{CE}	$V_{CE} = 0V$ to 5.5V	--	0	--	μA
Output Leakage Current		$I_{LEAKAGE}$	$V_{CE} = 0V$, $R_{LOAD} = 0\Omega$	--	0.5	10	μA
Output Turn-On Rise Time		T_{ON_RISE}	10% to 90% of V_{OUT} rising	--	1.5	--	ms
Current Limit Factor (Note 5)			$I_{LIM} \times R_{SET}$	--	210k	--	A · Ω
Max. Current Limit Setting (Note 6)		I_{LIMSET}	$V_{IN} = 3.3V$ to 5.5V, $R_{SET} = 60k\Omega$	--	--	3.5	A
Current Limit Setting Accuracy		ΔI_{LIMSET}	$I_{LIMSET} = 0.5A$ to 3A ($R_{SET} = 420k\Omega$ to 70kΩ)	-20	--	+20	%
FLAG Output Resistance		R_{FLG}	$I_{SINK} = 1mA$	--	15	400	Ω
FLAG Off Current		I_{FLG_OFF}	$V_{FLG} = 5V$	--	0.01	1	μA
FLAG Delay Time (Note 4)		t_D	Form fault condition to \overline{FLG} assertion	2	4.6	8	ms
Under-Voltage Lockout		V_{UVLO}	V_{IN} increasing	1.3	1.7	--	V
Under-Voltage Hysteresis		ΔV_{UVLO}	V_{IN} decreasing	--	0.1	--	V

Parameter	Symbol	Test Conditions	Min	Typ	Max	Unit
Thermal Shutdown Protection	T_{SD}		--	130	--	°C
Thermal Shutdown Hysteresis	ΔT_{SD}		--	10	--	°C

Note 1. Stresses listed as the above "Absolute Maximum Ratings" may cause permanent damage to the device. These are for stress ratings. Functional operation of the device at these or any other conditions beyond those indicated in the operational sections of the specifications is not implied. Exposure to absolute maximum rating conditions for extended periods may remain possibility to affect device reliability.

Note 2. Devices are ESD sensitive. Handling precaution recommended.

Note 3. The device is not guaranteed to function outside its operating conditions.

Note 4. The FLAG delay time is input voltage dependent, see "Typical Operating Characteristics" graph for further details.

Note 5. Current limit is determined by: $I_{LIMIT} = 210k/R_{SET}$, where R_{SET} is in ohms.

Note 6. It is important to note that the maximum current limit value shall be set properly in accordance with its supply voltage otherwise which it may result in the failure occurrence. See "Maximum Current Limit vs. Supply Voltage" graph shown on the applications information section for further details.

Note 7. For input voltage lower than 5V, the threshold level will subject to $\pm 0.6V$ deviation throughout the operating junction temperature range. Refer to the "Typical Operating Characteristics" graph for further details.

Note 8. $R_{DS(ON)}$ is measured at constant junction temperature by using a 1ms current pulse.

Typical Operating Characteristics

② On-State Supply Current vs. Input Voltage

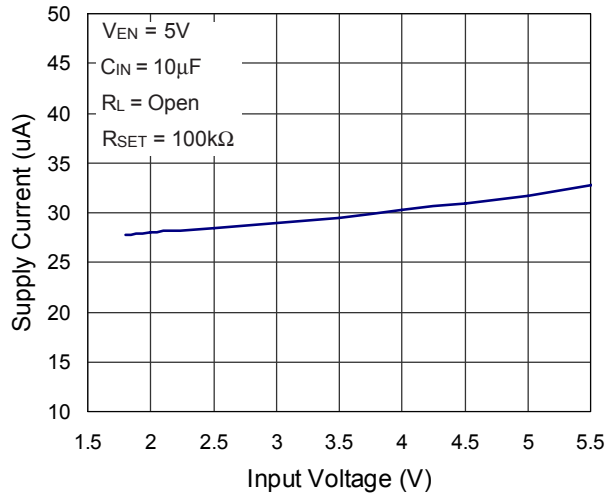

② Off-State Supply Current vs. Input Voltage

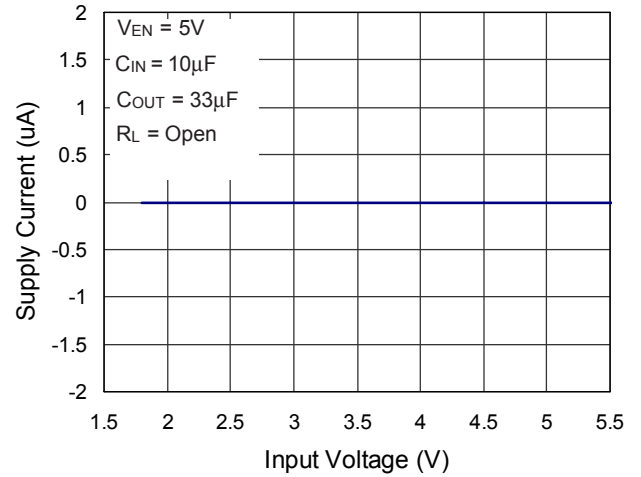

② On-State Supply Current vs. Temperature

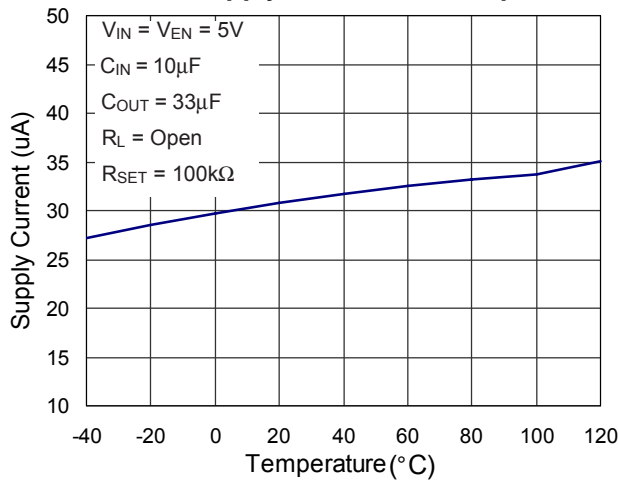

② Off-State Supply Current vs. Temperature

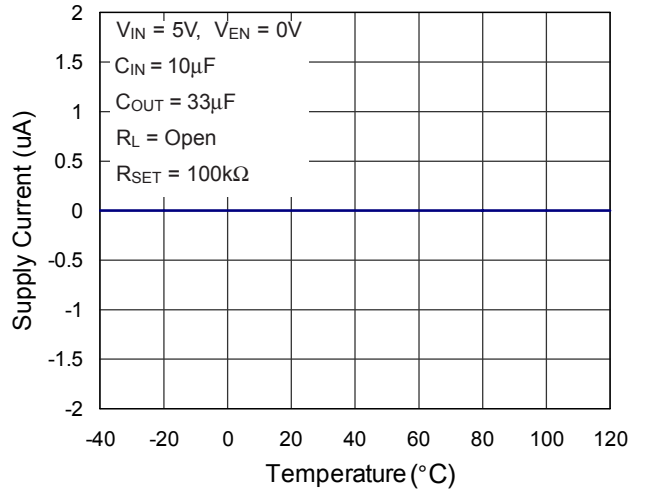

⑤ Current Limit vs. Input Voltage

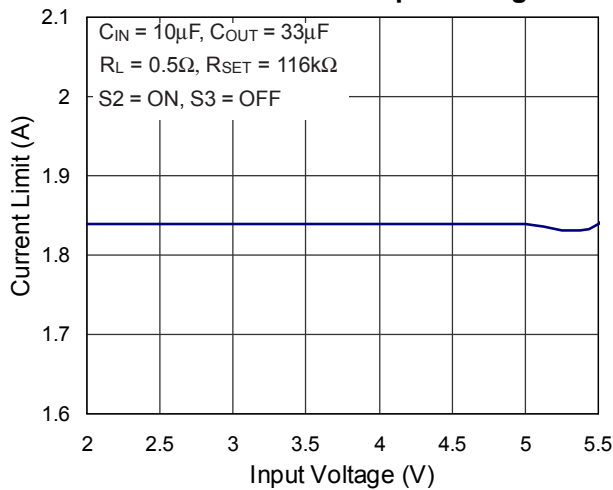

⑤ Current Limit vs. Temperature

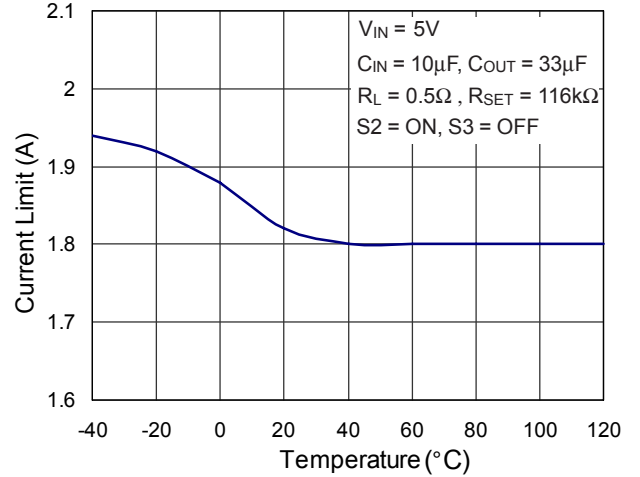

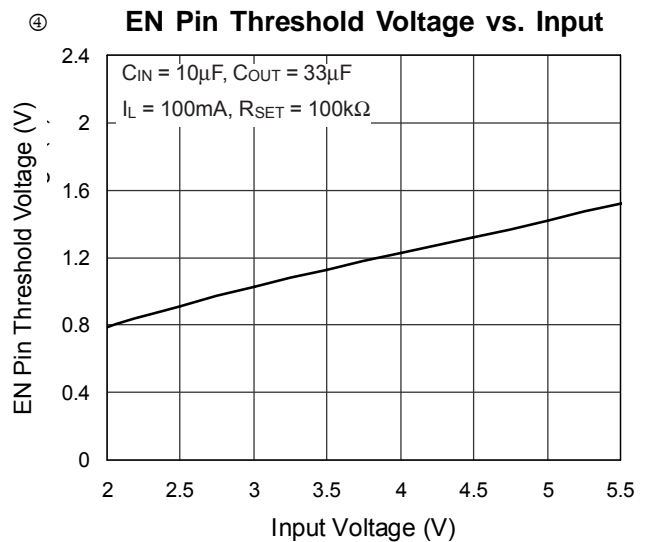
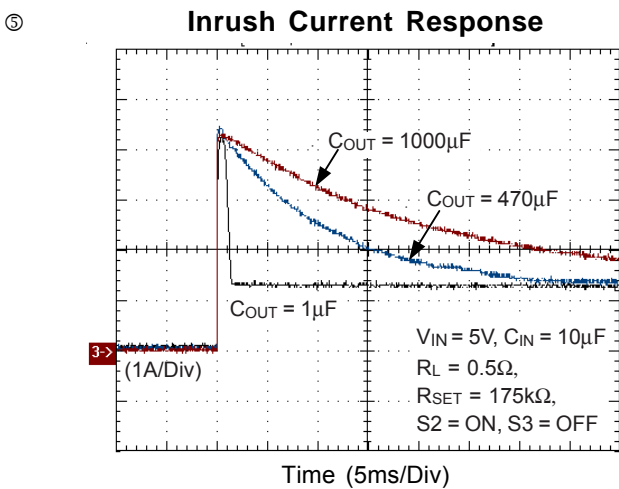
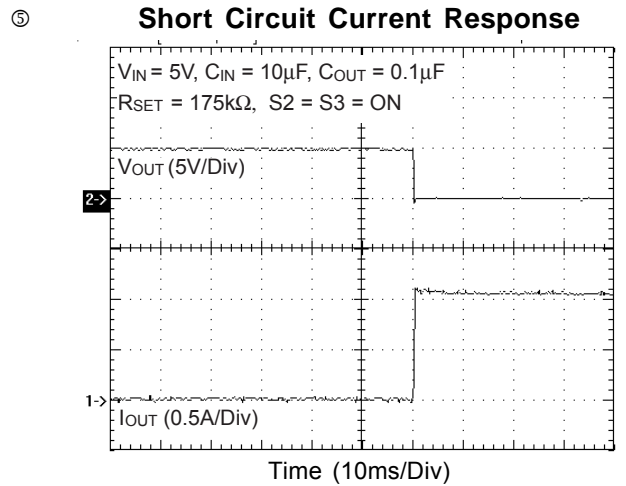
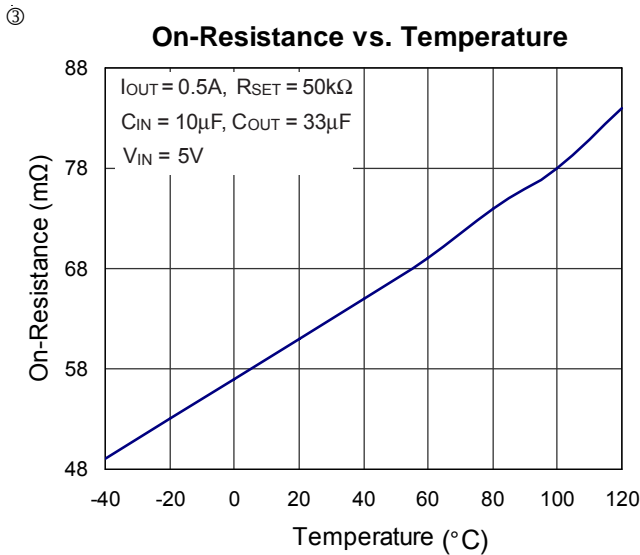
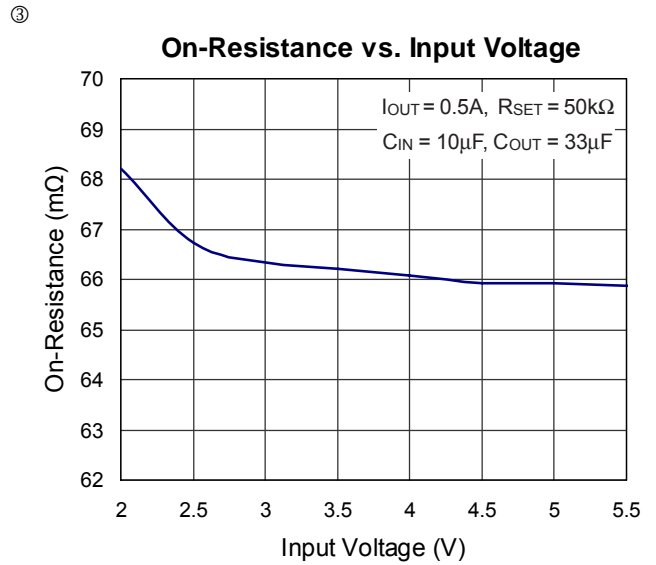
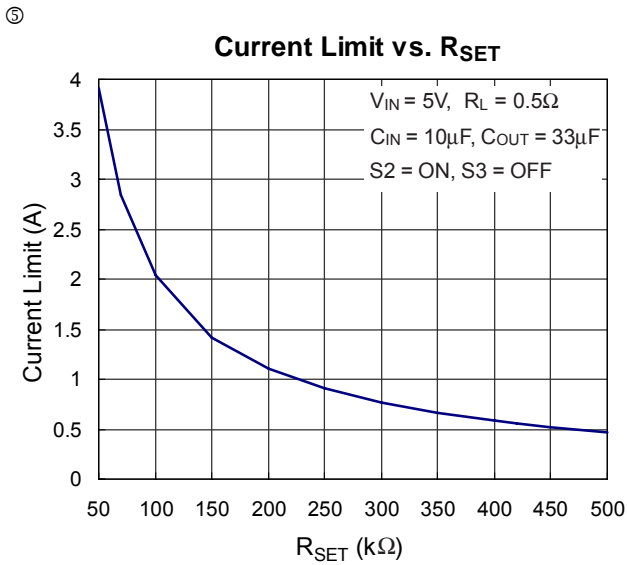

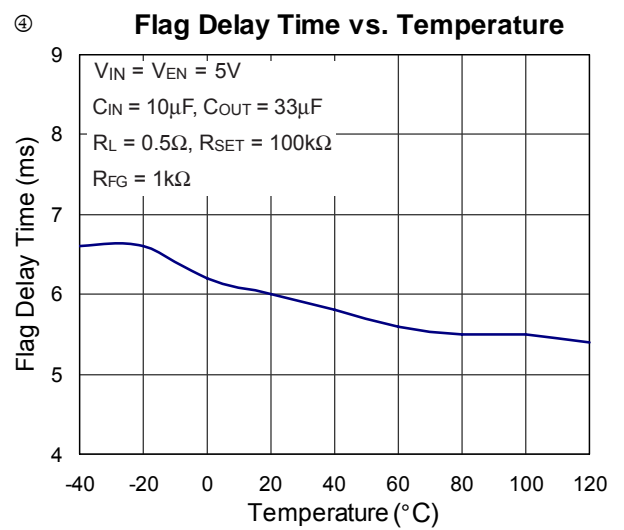
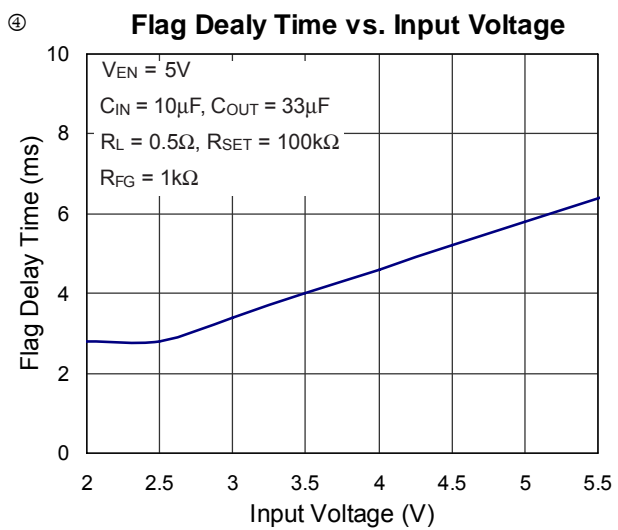
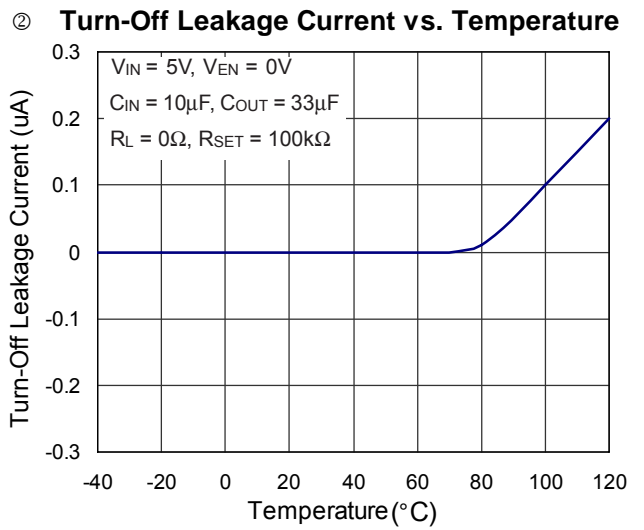
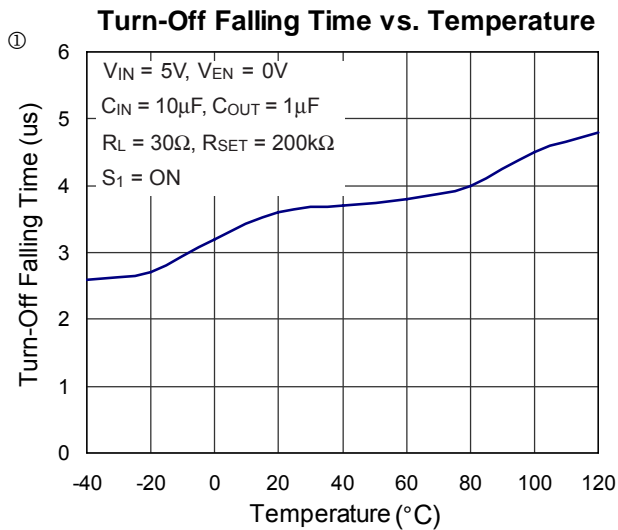
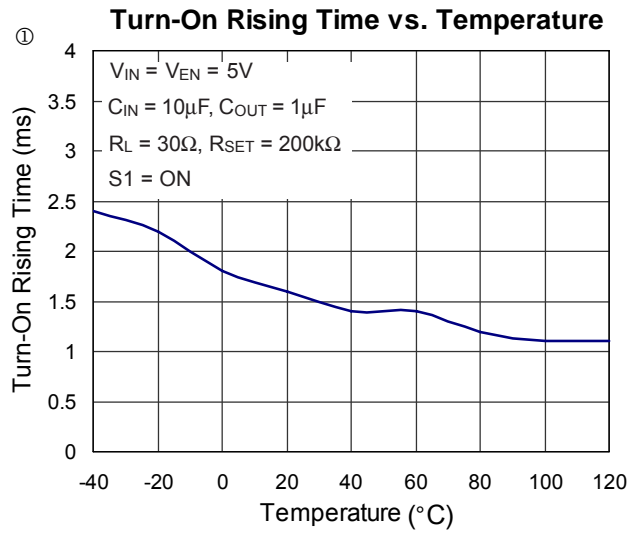
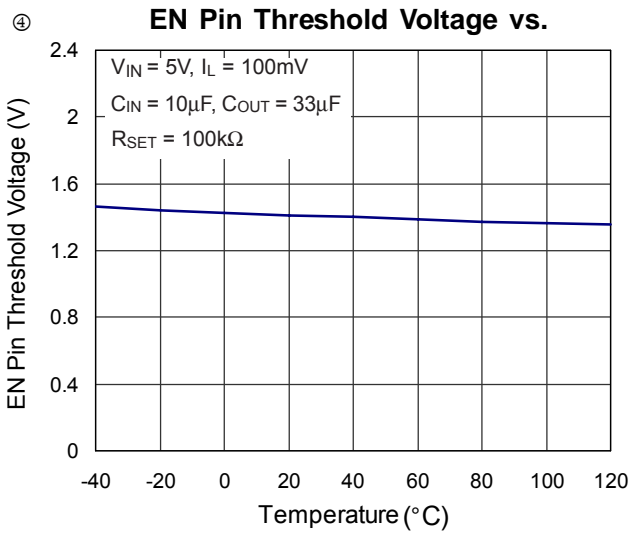

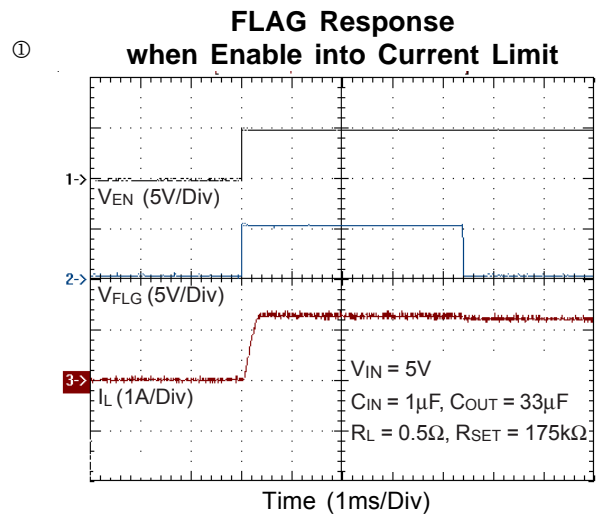
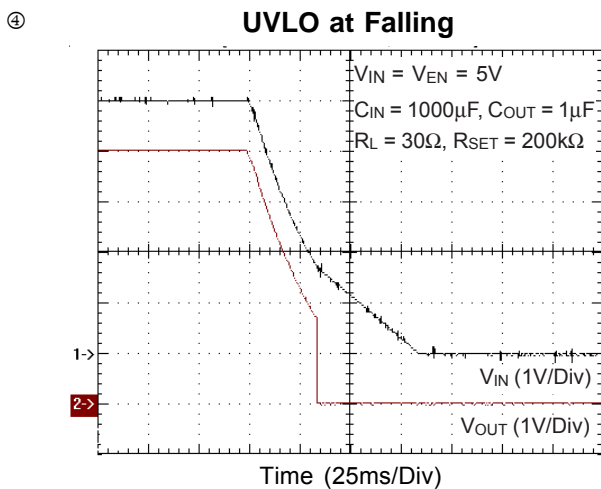
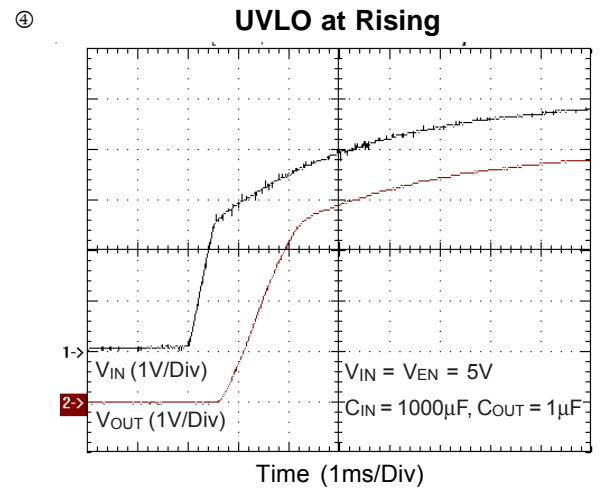
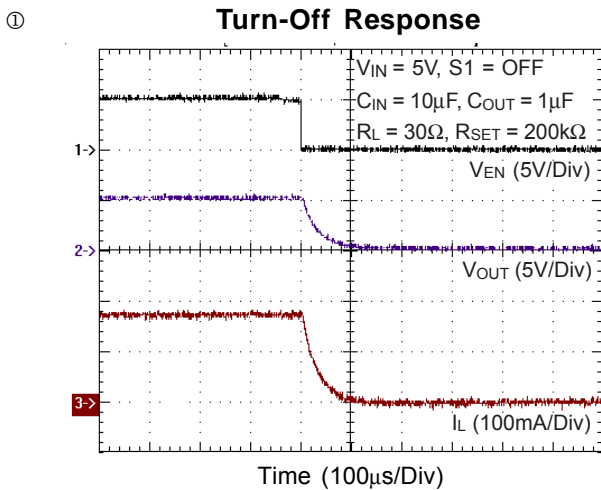
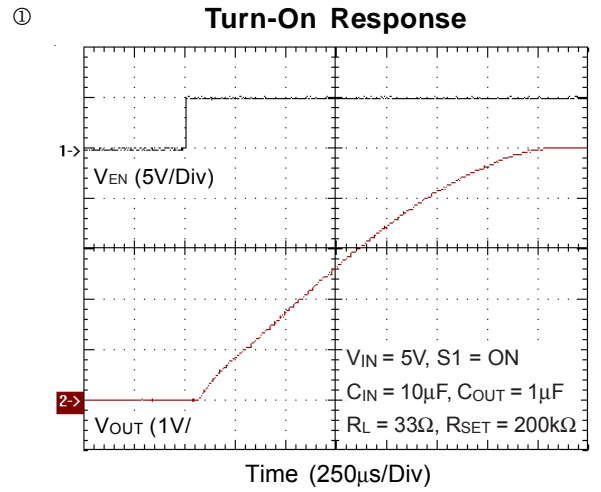
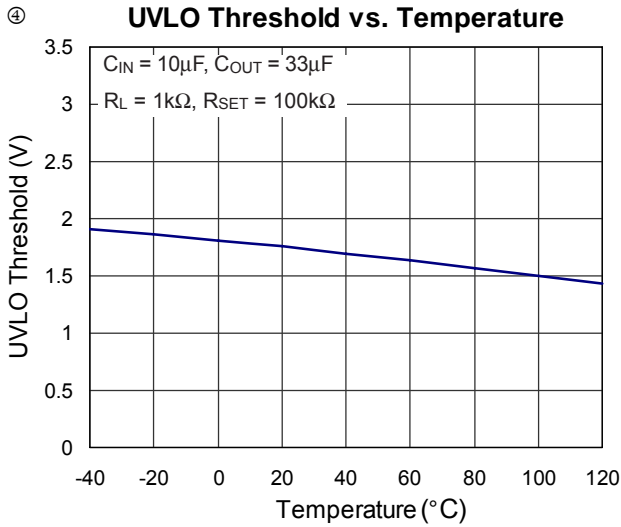

① FLAG Response at Chip Enable

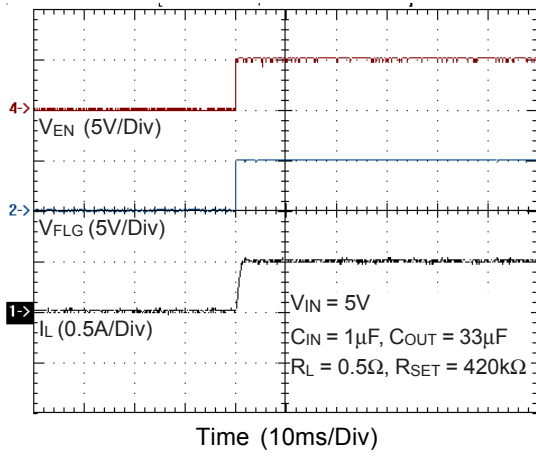

⑤ Current Limit with Thermal Shutdown

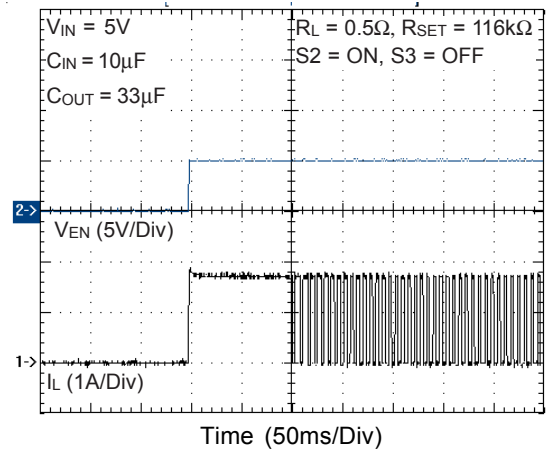

⑥ Short-Circuit with Thermal Shutdown

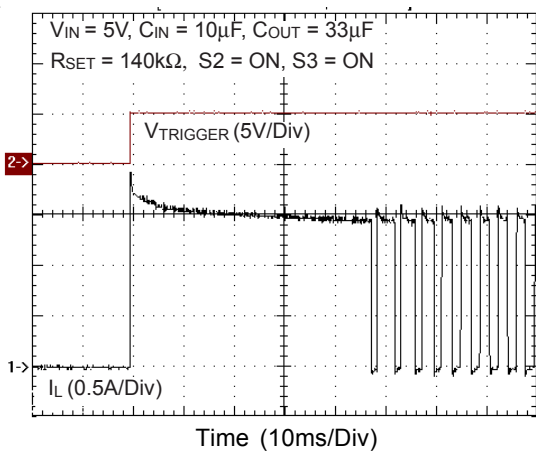

⑤ Soft-Start Response with Current Limit

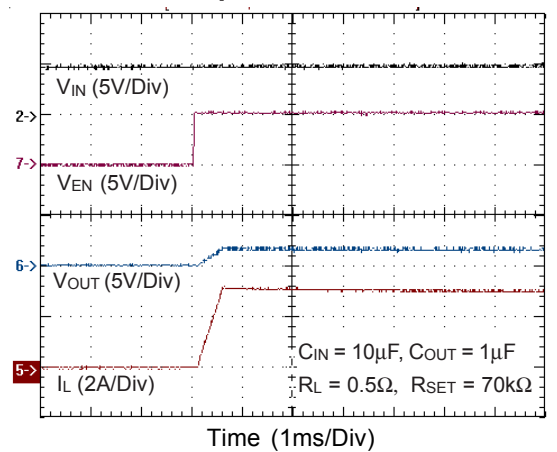

Applications Information

The RT9703 is a high-side, N-Channel, power switch available with active high enable input. Low $R_{DS(ON)} \approx 80m\Omega$ and full protection functions make it optimized to replace complex discrete on/off control circuitry.

Input and Output

V_{IN} (input) is the power source connection to the internal circuitry and the drain of the MOSFET. V_{OUT} (output) is the source of the MOSFET. In a typical application, current flows through the switch from V_{IN} to V_{OUT} toward the load. If V_{OUT} is greater than V_{IN} , current will flow from V_{OUT} to V_{IN} since the MOSFET is bidirectional when on.

Unlike a normal MOSFET, there is no a parasitic body diode between drain and source of the MOSFET, the RT9703 prevents reverse current flow if V_{OUT} being externally forced to a higher voltage than V_{IN} when the output disabled ($V_{EN} < 0.8V$).

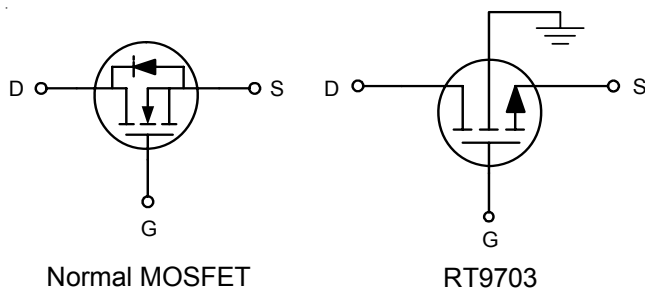

Chip Enable Input

The switch will be disabled when the EN pin is in a logic low condition. During this condition, the internal circuitry and MOSFET are turned off, reducing the supply current to $0.1\mu A$ typically. The maximum guaranteed voltage for a logic low at the EN pin is $0.8V$. A minimum guaranteed voltage of $2V$ at the EN pin will turn the RT9703 back on. Floating the input may cause unpredictable operation. EN should not be allowed to go negative with respect to GND. The EN pin may be directly tied to V_{IN} to keep the part on.

Soft-Start for Hot Plug-In Applications

In order to eliminate the upstream voltage droop caused by the large inrush current during hot-plug events, the “soft-start” feature effectively isolates the power source from extremely large capacitive loads.

Fault Flag

The RT9703 provides a FLG signal pin which is an N-Channel open drain MOSFET output. This open drain output goes low when $V_{OUT} < V_{IN} - 1V$, current limit or the die temperature exceeds $130^{\circ}C$ approximately. The FLG output is capable of sinking a $10mA$ load to typically $150mV$ above ground. The FLG pin requires a pull-up resistor, this resistor should be large in value to reduce energy drain. A $100k\Omega$ pull-up resistor works well for most applications. In the case of an over-current condition, FLG will be asserted only after the flag response delay time, t_D , has elapsed. This ensures that FLG is asserted only upon valid over-current conditions and that erroneous error reporting is eliminated.

For example, false over-current conditions may occur during hot-plug events when a highly large capacitive load is connected and causes a high transient inrush current that exceeds the current limit threshold. The FLG response delay time t_D is typically $4.6ms$.

Under-voltage Lockout

Under-voltage lockout (UVLO) prevents the MOSFET switch from turning on until input voltage exceeds approximately $1.7V$. If input voltage drops below approximately $1.3V$, UVLO turns off the MOSFET switch, FLG will be asserted accordingly. Under-voltage detection functions only when the chip enable input is enabled.

Current Limiting and Short-Circuit Protection

The current limit circuitry prevents damage to the MOSFET switch and external load. It is user adjustable with an external set resistor, $I_{LIMIT} = 210k\Omega / R_{SET}$ in the range of $0.5A$ to $3A$. The accuracy of current limit set point may vary with operating temperature and supply voltage. See “Typical Operating Characteristics” graph for further details.

The normal current limit value, I_{LIMIT} , is set with an external resistor between IP (pin 8) and GND (pin 4). When a heavy load or short circuit is applied to an enabled switch, a large transient current may flow until the current limit circuitry responds. Once this current limit threshold is exceeded, the device enters constant current mode until the thermal shutdown occurred or the fault is removed. It is important to note that the maximum current limit value shall be set properly in accordance with its supply voltage otherwise it may result in the failure occurrence. The graph below shows the maximum current limit and supply voltage on the safe operation area.

Maximum Current Limit vs. Supply Voltage

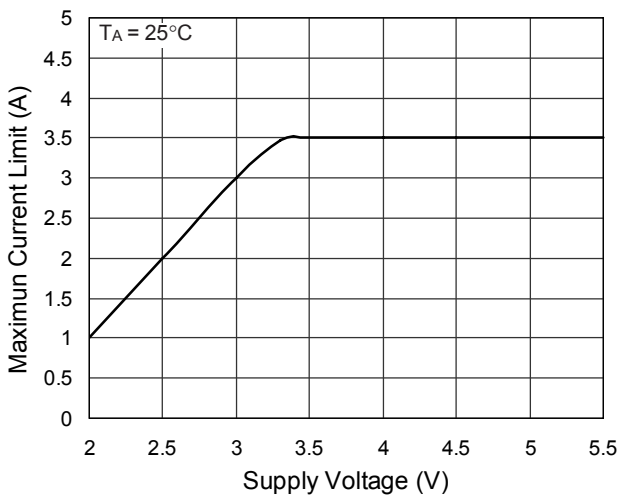

Thermal Shutdown

Thermal shutdown is employed to protect the device from damage if the die temperature exceeds approximately 130°C. If enabled, the switch automatically restarts when the die temperature falls 10°C. The output and FLG signal will continue to cycle on and off until the device is disabled or the fault is removed.

Power Dissipation

The device's junction temperature depends on several factors such as the load, PCB layout, ambient temperature and package type. The output pin of RT9703 can deliver a current of up to 3A over the full operating junction temperature range. However, the maximum output current must be derated at higher ambient temperature to ensure

the junction temperature does not exceed 100°C. With all possible conditions, the junction temperature must be within the range specified under operating conditions. Power dissipation can be calculated based on the output current and the $R_{DS(ON)}$ of switch as below.

$$P_D = R_{DS(ON)} \times I_{OUT}^2$$

Although the devices are rated for 3A of output current, but the application may limit the amount of output current based on the total power dissipation and the ambient temperature. The final operating junction temperature for any set of conditions can be estimated by the following thermal equation :

$$P_{D(MAX)} = (T_{J(MAX)} - T_A) / \theta_{JA}$$

Where $T_{J(MAX)}$ is the maximum junction temperature of the die (100°C) and T_A is the maximum ambient temperature. The junction to ambient thermal resistance (θ_{JA}) for SOP-8 package at recommended minimum footprint is 104°C/W (θ_{JA} is layout dependent).

Supply Filter/Bypass Capacitor

A 10µF low-ESR ceramic capacitor from V_{IN} to GND (the amount of the capacitance may be increased without limit), located at the device is strongly recommended to prevent the input voltage drooping during hot-plug events. However, higher capacitor values will further reduce the voltage droop on the input. Furthermore, without the bypass capacitor, an output short may cause sufficient ringing on the input (from source lead inductance) to destroy the internal control circuitry. An important note to be aware of is the parasitic inductance of PCB traces can cause over-voltage transients if the PCB trace has even a few tens of nH of inductance. It is recommended to use aluminum electrolytic acted the supply capacitor to prevent the device from being damaged. The input transient **MUST** not exceed 6.5V of the absolute maximum supply voltage even for a short duration.

Fault Flag Filtering (Optional)

The transient inrush current to downstream capacitance may cause a short-duration error flag, which may cause erroneous over-current reporting. A simple 1ms RC low-pass filter (10kΩ and 0.1μF) in the flag line eliminates short-duration transients.

PCB Layout

In order to meet the voltage drop, droop, and EMI requirements, careful PCB layout is necessary. The following guidelines must be considered:

- Keep all input and output traces as short as possible and use at least 150-mil & 2 ounce copper for all traces.
- Avoid vias as much as possible. If vias are necessary, make them as large as feasible.
- Place a ground plane under all circuitry to lower both resistance and inductance and improve DC and transient performance (Use a separate ground and power planes if possible).
- Locate the bypass capacitors as close as possible to the input and output pin of the RT9703.

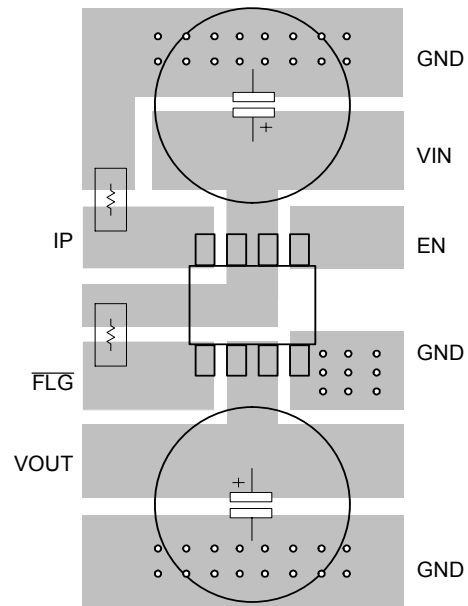

Board Layout

Outline Dimension

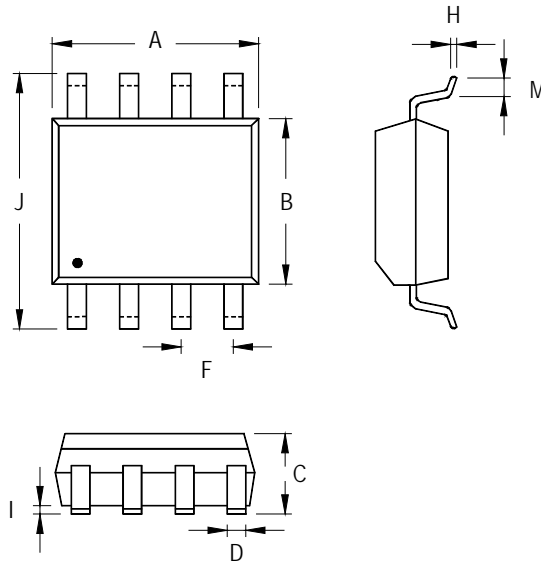

Symbol	Dimensions In Millimeters		Dimensions In Inches	
	Min	Max	Min	Max
A	4.801	5.004	0.189	0.197
B	3.810	3.988	0.150	0.157
C	1.346	1.753	0.053	0.069
D	0.330	0.508	0.013	0.020
F	1.194	1.346	0.047	0.053
H	0.170	0.254	0.007	0.010
I	0.050	0.254	0.002	0.010
J	5.791	6.200	0.228	0.244
M	0.400	1.270	0.016	0.050

8-Lead SOP Plastic Package

Richtek Technology Corporation

Headquarter
 5F, No. 20, Taiyuen Street, Chupei City
 Hsinchu, Taiwan, R.O.C.
 Tel: (8863)5526789 Fax: (8863)5526611

Richtek Technology Corporation

Taipei Office (Marketing)
 5F, No. 95, Minchiuan Road, Hsintien City
 Taipei County, Taiwan, R.O.C.
 Tel: (8862)86672399 Fax: (8862)86672377
 Email: marketing@richtek.com

Information that is provided by Richtek Technology Corporation is believed to be accurate and reliable. Richtek reserves the right to make any change in circuit design, specification or other related things if necessary without notice at any time. No third party intellectual property infringement of the applications should be guaranteed by users when integrating Richtek products into any application. No legal responsibility for any said applications is assumed by Richtek.