

Description

The AP3039 is a current mode high voltage low-side N-channel MOSFET controller which is ideal for boost regulators. It contains all the features needed to implement single ended primary topology DC/DC converters.

The input voltage range of AP3039 is from 5V to 27V. Its operation frequency is adjustable from 150kHz to 1MHz.

The AP3039 has UVLO (Under Voltage Lock Out) circuit. It uses two external resistors to set the UVLO voltage. The AP3039 also has an over output voltage protection to limit the output voltage. The OVP voltage can be set through external resistors. If the output voltage is higher than the OVP high threshold point, it will disable the driver, when the output voltage drops to the OVP low threshold point, it will enable the driver. It also features a soft start to reduce the inrush current when power on, the soft start time can be set through an external capacitor.

The AP3039 is available in QFN-3x3-16 and SOIC-14 packages.

Features

- Input Voltage Range 5V to 27V
- 0.6A Peak MOSFET Gate Driver
- 20ns Quick MOSFET Gate Driver
- Duty Cycle Limit of 90%
- Programmable UVLO
- Programmable Over Voltage Protection
- Cycle by Cycle Current Limit
- Adjustable Soft-Start
- Adjustable Operation Frequency from 150kHz to 1MHz

Pin Assignments

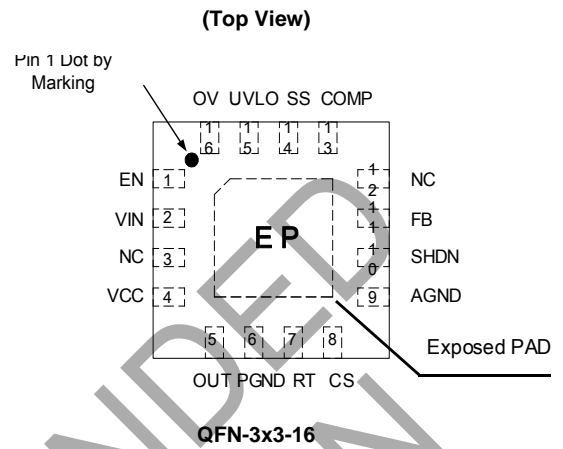

(Top View)

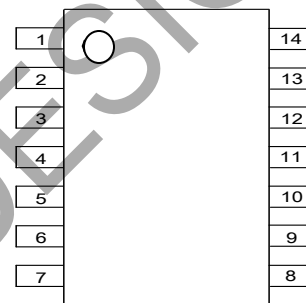

SOIC-14

Applications

- LED Lighting
- Notebook
- LCD Display Modules

Typical Applications Circuit

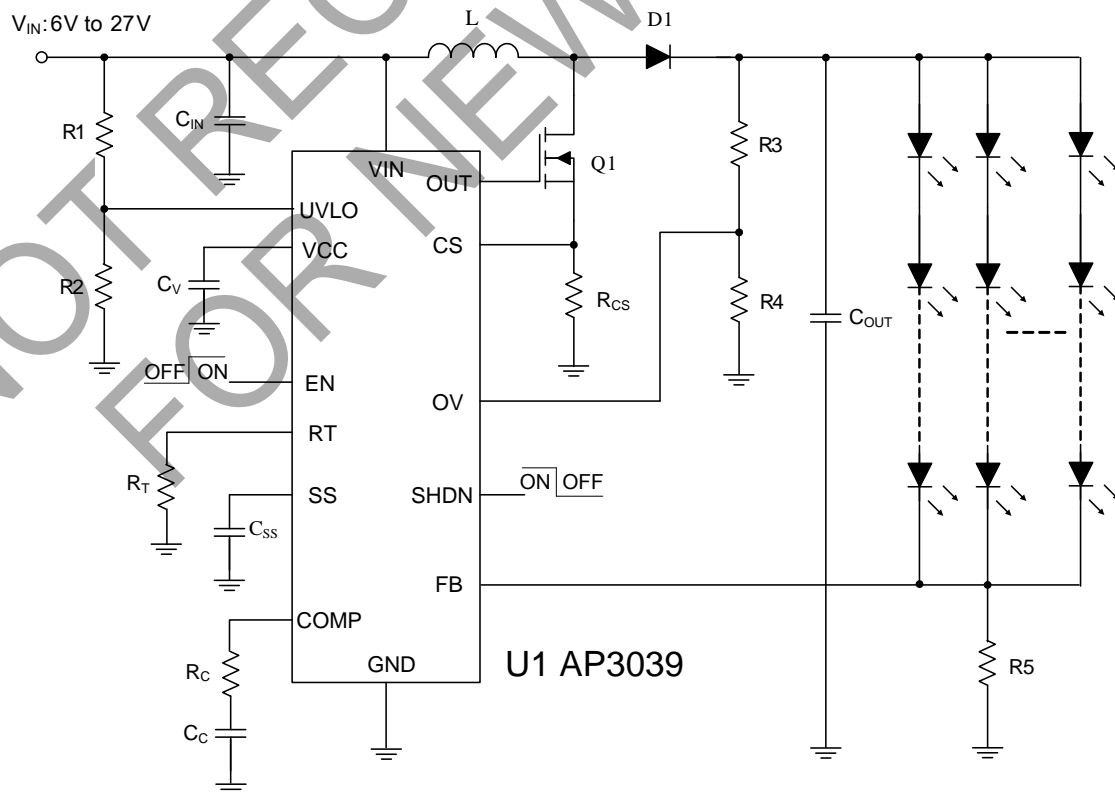
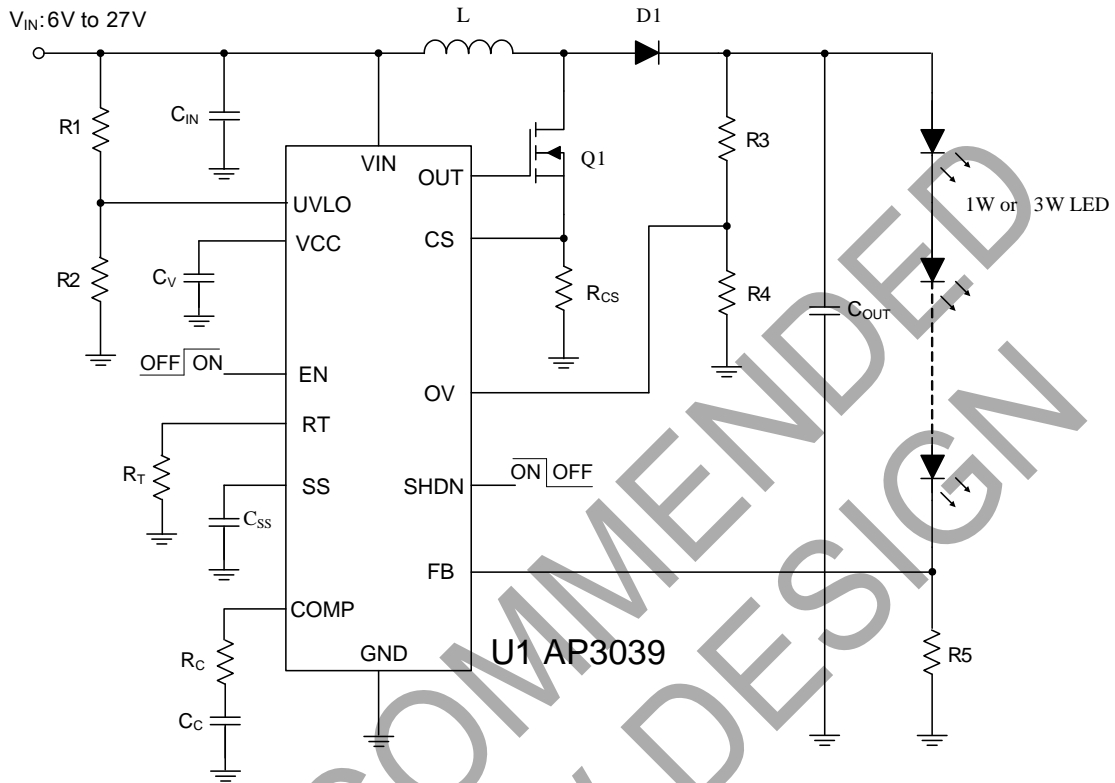

Typical Applications Circuit (Cont.) (Note 1, 2 and 3)

Note 1: The output voltage is decided by R5, R6 and the internal 0.5V reference. The output voltage accuracy is determined by the accuracy of R5 and R6, for which the precise resistors are preferred.

$$V_{OUT} = \frac{0.5V}{R6} * (R5 + R6)$$

Note 2: In this application, the LED current is controlled by the feedback resistor R5. LEDs current accuracy is determined by regulator's feedback threshold accuracy and is independent of the LEDs forward voltage variation. So the precise resistors are the better choices. The resistance of R5 is in inverse proportion to the LED current since the feedback reference is fixed at 0.5V. The relation of R5 and the LED current can be expressed as below:

$$R5 = \frac{0.5V}{I_{LED}}$$

Note 3: The summation of LED current is determined by R5 and internal 0.5V reference same as the illustration in Figure 22.
More detailed application information please refer to application note.

NOT RECOMMENDED
FOR NEW DESIGN

Pin Descriptions

Pin Number		Pin Name	Function
16-pin	14-pin		
1	3	EN	Enable pin
2	4	VIN	Input supply pin, must be locally bypassed
3, 12	–	NC	No connection (for QFN-3x3-16 package only)
4	5	VCC	6V linear regulator output pin. VCC is used to bias the gate driver for the external MOSFET. If VIN is less than 8.5V, the VCC is equal to VIN minus drop voltage across bypass switch. If VIN is less than 6V, connect VCC to VIN. This pin should be bypassed to GND (recommend to connect with AGND pin) with a ceramic capacitor
5	6	OUT	Connect this pin to the gate of external MOSFET, the gate driver has 0.6A peak current capability
6	7	PGND	Power ground
7	8	RT	An external resistor connected from this pin to GND to set the operating frequency
8	9	CS	Sense switch current pin, which is used for current mode control and for current limit
9	10	AGND	Reference ground
10	11	SHDN	This pin can be connected to current matched chip and receives error signal used to shut down the system
11	12	FB	Voltage Feedback Pin. The reference voltage is 500mV
13	13	COMP	Compensation Pin. This pin is the output of the internal Error Amplifier
14	14	SS	An external soft start time capacitor is connected from this pin to ground and is charged by internal 12mA current source to control regulator soft start time
15	1	UVLO	Two resistors connected from this pin to ground and the VIN pin respectively to set start up and shutdown level
16	2	OV	Over output voltage protection pin
–	–	EP	Exposed backside pad. Solder to the circuit board ground plane with sufficient copper connection to ensure low thermal resistance (for QFN-3x3-16 package only)

Functional Block Diagram

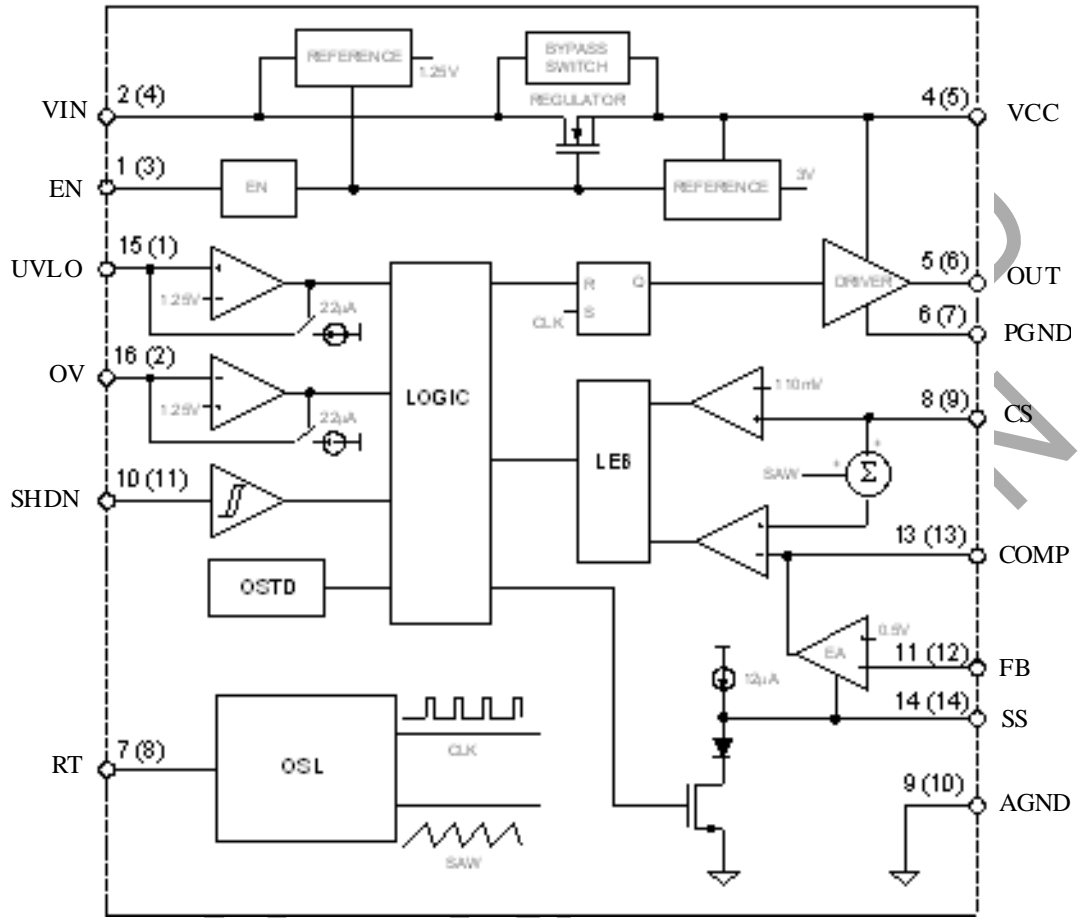

A (B)
A QFN-3x3-16
B SOIC-14

NOT FOR NEW DESIGN

Absolute Maximum Ratings (Note 4)

Symbol	Parameter	Value		Unit
V_{IN}	Input Voltage	30		V
V_{CC}	VCC Pin Voltage	10		V
V_{OUT}	OUT Pin Voltage	10		V
V_{FB}	Feedback Pin Voltage	7		V
V_{UVLO}	UVLO Pin Voltage	7		V
V_{CS}	CS Pin Voltage	7		V
V_{SHDN}	SHDN Pin Voltage	7		V
V_{EN}	Enable Pin Voltage	V_{IN}		V
V_{OV}	OV Pin Voltage	7		V
θ_{JA}	Thermal Resistance (Junction to Ambient, no Heat sink)	QFN-3x3-16	60	°C/W
		SOIC-14	102	
T_J	Operating Junction Temperature	+150		°C
T_{STG}	Storage Temperature Range	-65 to +150		°C
T_{LEAD}	Lead Temperature (Soldering, 10sec)	+260		°C
–	ESD (Machine Model)	200		V
–	ESD (Human Body Model)	2000		V

Note 4: Stresses greater than those listed under "Absolute Maximum Ratings" may cause permanent damage to the device. These are stress ratings only, and functional operation of the device at these or any other conditions beyond those indicated under "Recommended Operating Conditions" is not implied. Exposure to "Absolute Maximum Ratings" for extended periods may affect device reliability.

Recommended Operating Conditions

Symbol	Parameter	Min	Max	Unit
V_{IN}	Input Voltage	5	27	V
f	Operating Frequency	150	1000	kHz
T_A	Operating Temperature	-40	+85	°C

Electrical Characteristics ($V_{IN}=12V$, $V_{EN}=V_{IN}$, $T_A=+25^{\circ}C$, unless otherwise specified.)

Symbol	Parameter	Conditions	Min	Typ	Max	Unit
V_{IN}	Input Voltage	$V_{CC}=V_{IN}$	5	–	6	V
		V_{CC} bypassed to GND through a 0.47 μ F capacitor	6	–	27	
V_{FB}	Feedback Voltage	–	490	500	510	mV
I_{FB}	FB Pin Bias Current	–	–	35	100	nA
I_Q	Quiescent Current	No switching	–	3	5	mA
I_{SHDN}	Shutdown Quiescent Current	$V_{EN}=0V$	–	1	2	μ A
V_{CC}	VCC Voltage	$9V \leq V_{IN} \leq 27V$	5.5	6	6.5	V
		$6V \leq V_{IN} \leq 9V$	5	–	–	
I_{CC-LIM}	VCC Current Limit	–	–	50	–	mA
$V_{IN-V_{CC}}$	Drop Voltage Across Bypass Switch	$I_{CC}=0mA$, $f_{osc} \leq 200kHz$, $6V \leq V_{IN} \leq 8.5V$	–	300	–	mV
V_{BYP-HI}	Bypass Switch Turn-off Threshold	V_{IN} increasing	–	8.7	–	V
$V_{BYP-HYS}$	Bypass Switch Threshold Hysteresis	V_{IN} decreasing	–	260	–	mV
V_{CC-HI}	VCC Pin UVLO Rising Threshold	–	–	4.7	–	V
V_{CC-HYS}	VCC Pin UVLO Falling Hysteresis	–	–	300	–	mV
f_{OSC}	Oscillator Frequency	Adjustable, $R_T=51k\Omega$ to 470k Ω	150	–	1000	kHz
V_{UVLO}	UVLO Threshold	–	1.22	1.25	1.28	V
I_{HYS}	UVLO Hysteresis Current Source	–	–	22	–	μ A
V_{CS}	Current Limit Threshold Voltage	–	90	110	130	mV
V_{RT}	RT Voltage	–	1.20	1.25	1.30	V
G_S	Error Amplifier Transconductance	–	–	470	–	$\mu A/V$
V_{EH}	EN Pin Threshold Voltage	–	2.0	–	–	V
V_{EL}		–	–	–	0.5	
V_{IH}	SHDN Pin Threshold Voltage	–	2.0	–	–	V
V_{IL}		–	–	–	0.5	

Electrical Characteristics (Cont. $V_{IN}=12V$, $V_{EN}=V_{IN}$, $T_A=+25^{\circ}C$, unless otherwise specified.)

Symbol	Parameter	Conditions	Min	Typ	Max	Unit
V_{OV}	OV Threshold	–	–	1.25	–	V
I_{OV-HYS}	OV Hysteresis Current Source	–	–	22	–	μA
D_{MAX}	Maximum Duty Cycle	–	–	90	93	%
I_{SS}	Soft Start Current Source	–	–	12	–	μA
t_{RISE}	Out Pin Rise Time	Out Pin Load =1nF	–	20	–	ns
t_{FALL}	Out Pin Fall Time	Out Pin Load =1nF	–	20	–	ns
V_{OUT-H}	OUT Dropout Voltage ($V_{CC}-V_{OUT}$)	$I_{OUT}=50mA$	–	0.25	0.75	V
V_{OUT-L}	OUT Low Voltage Level (V_{OUT})	$I_{OUT}=100mA$	–	0.25	0.75	V
T_{OTSD}	Thermal Shutdown Temperature	–	–	+160	–	$^{\circ}C$
T_{HYS}	Thermal Shutdown Hysteresis	–	–	+20	–	$^{\circ}C$

NOT RECOMMENDED FOR NEW DESIGN

Performance Characteristics

Efficiency VS. Case Temperature

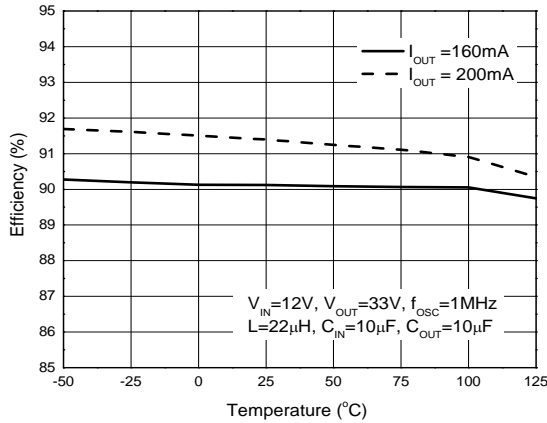

Efficiency VS. Input Voltage

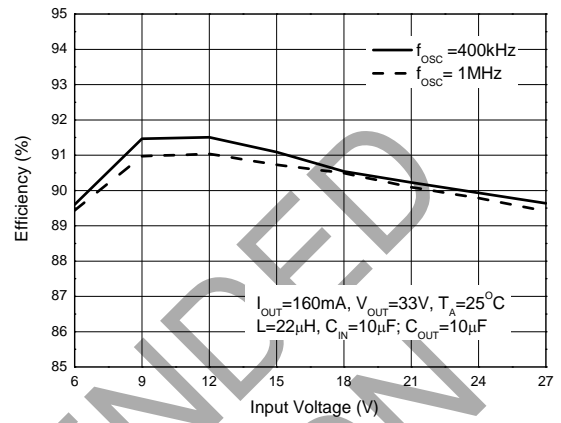

Efficiency VS. Output Current

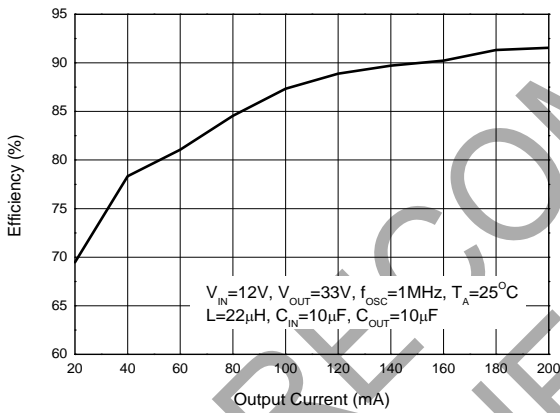

Efficiency VS. Output Voltage

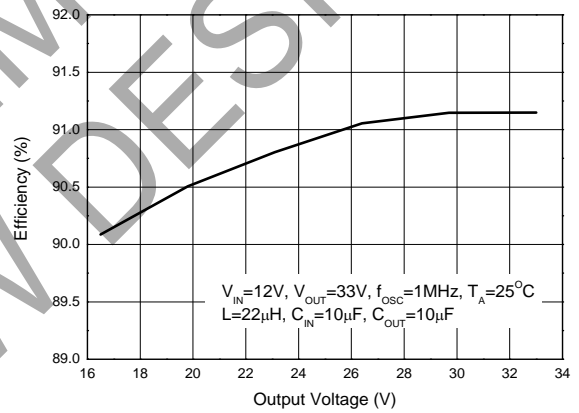

Quiescent Current VS. Input Voltage

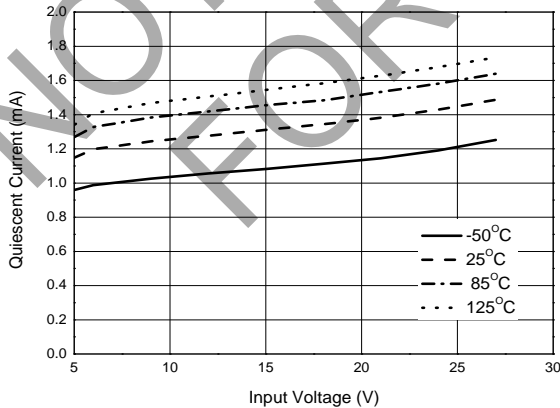

VCC Voltage VS. Input Voltage

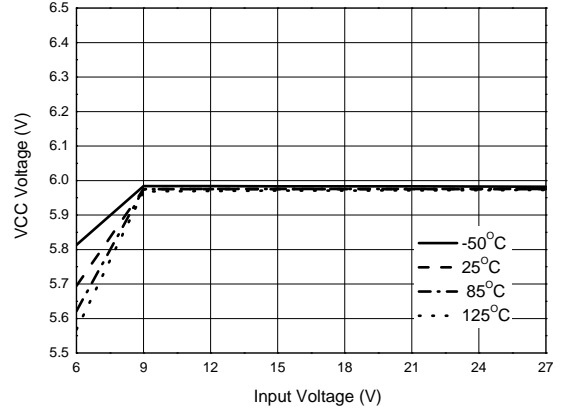

Performance Characteristics (Cont.)

Switching Frequency VS. Case Temperature

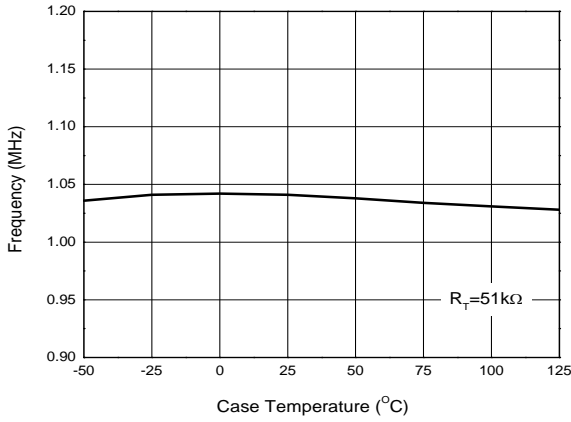

Switching Frequency VS. R_T Value

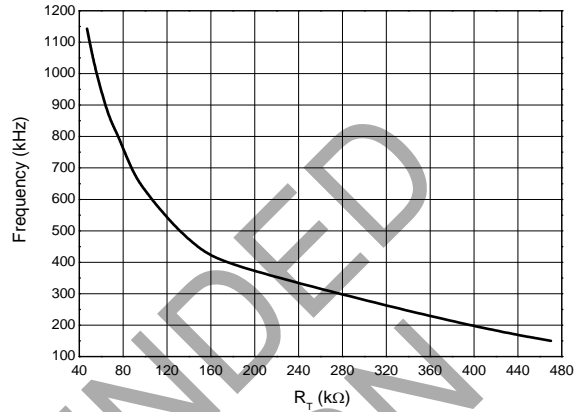

RT Voltage VS. Input Voltage

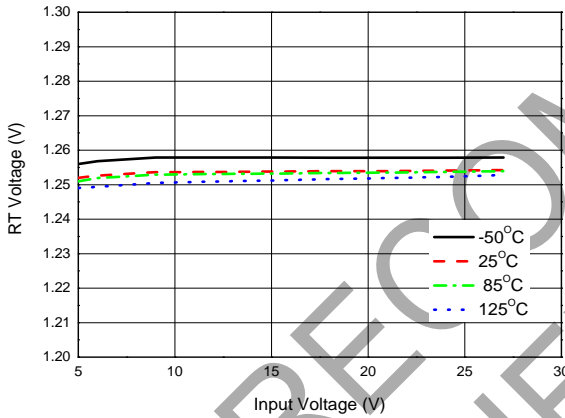

UVLO Voltage VS. Input Voltage

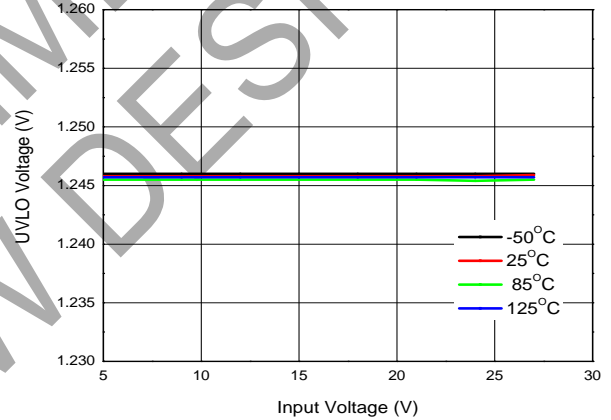

OV Voltage VS. Input Voltage

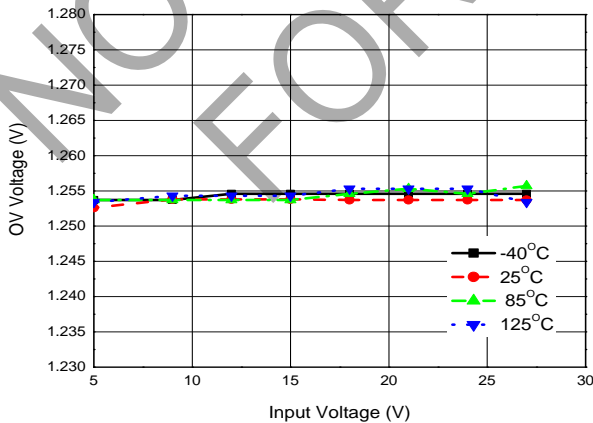

UVLO Current VS. Input Voltage

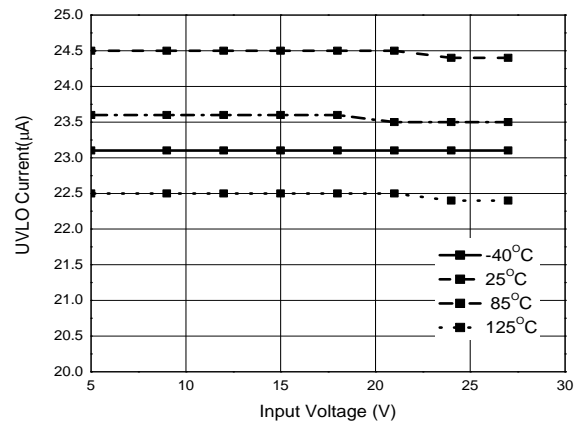

Performance Characteristics (Cont.)

OV Current VS. Input Voltage

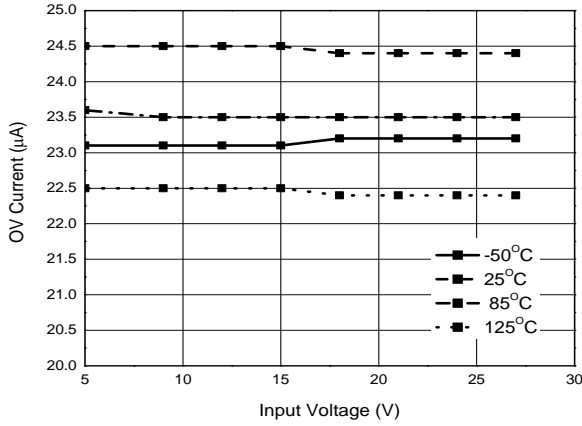

Feedback Voltage VS. Case Temperature

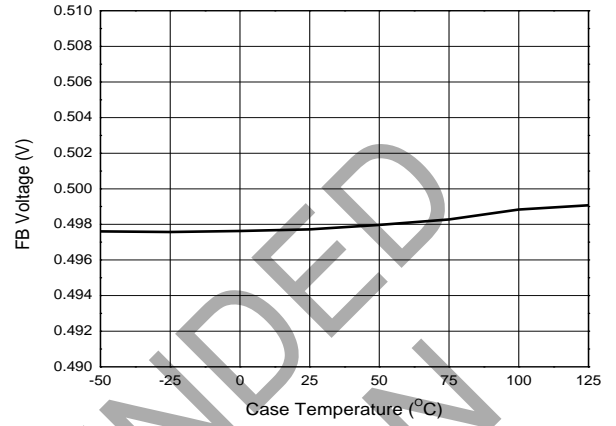

OUT Low Voltage VS. Case Temperature

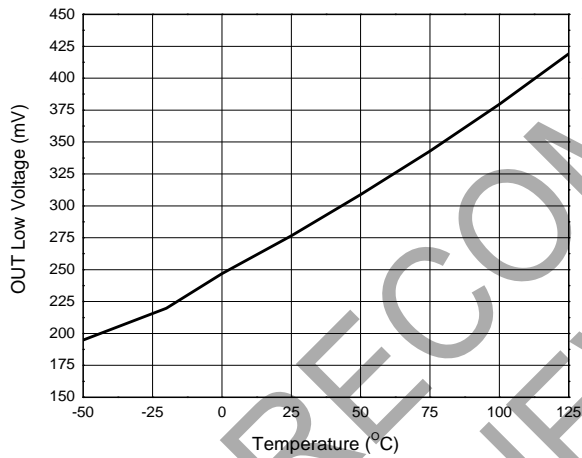

OUT Dropout Voltage VS. Case Temperature

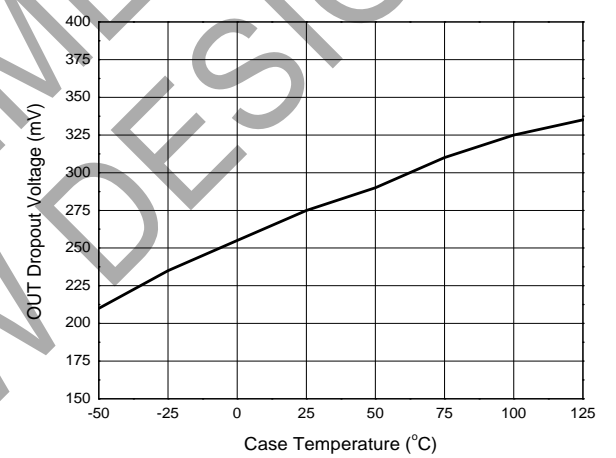

NOT RECOMMENDED FOR NEW DESIGN

Ordering Information

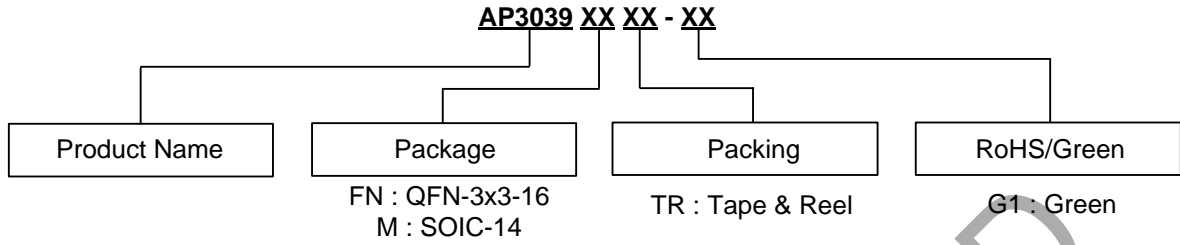

Package	Temperature Range	Part Number	Marking ID	Packing
QFN-3x3-16	-40 to+ 85°C	AP3039FNTR-G1	B2A	Tape & Reel
SOIC-14		AP3039M-G1	3039M-G1	Tube
		AP3039MTR-G1	3039M-G1	Tape & Reel

NOT RECOMMENDED FOR NEW DESIGN

Package Outline Dimensions (All dimensions in mm(inch).)

(1) Package Type: QFN-3x3-16

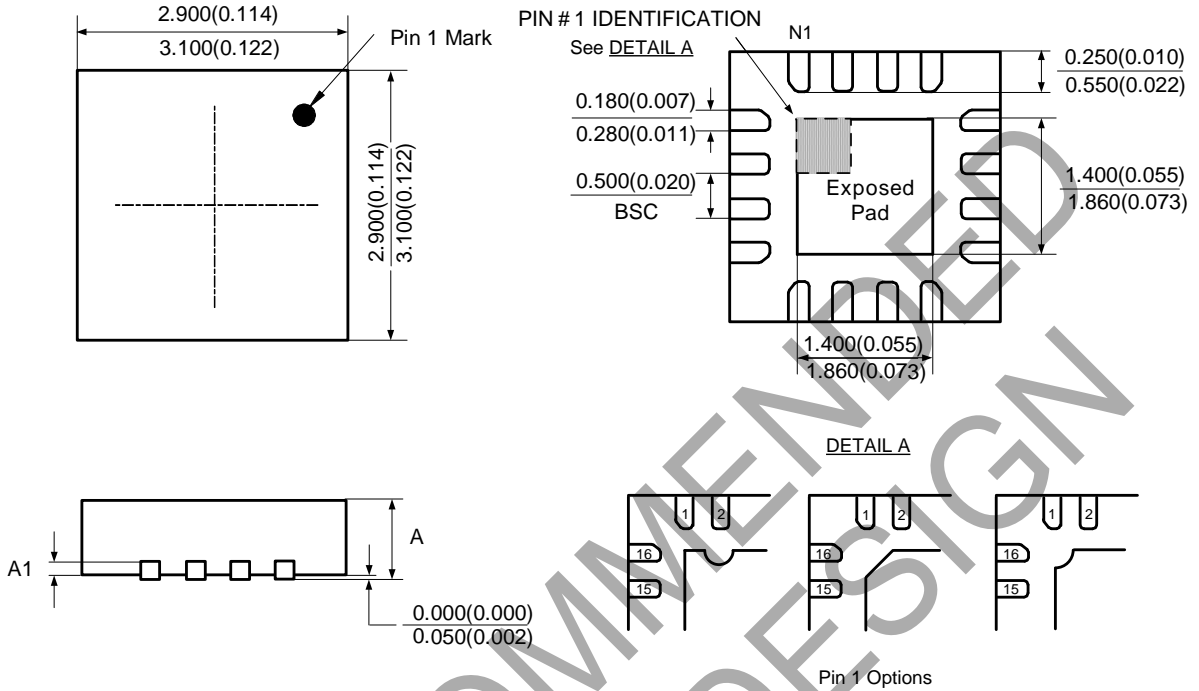

Symbol	A				A1			
	min(mm)	max(mm)	min(inch)	max(inch)	min(mm)	max(mm)	min(inch)	max(inch)
Option1	0.700	0.900	0.028	0.035	0.178	0.228	0.007	0.009
Option2	0.550	0.650	0.022	0.026	0.150 (TYP)		0.006 (TYP)	

Suggested Pad Layout

(1) Package Type: QFN-3x3-16

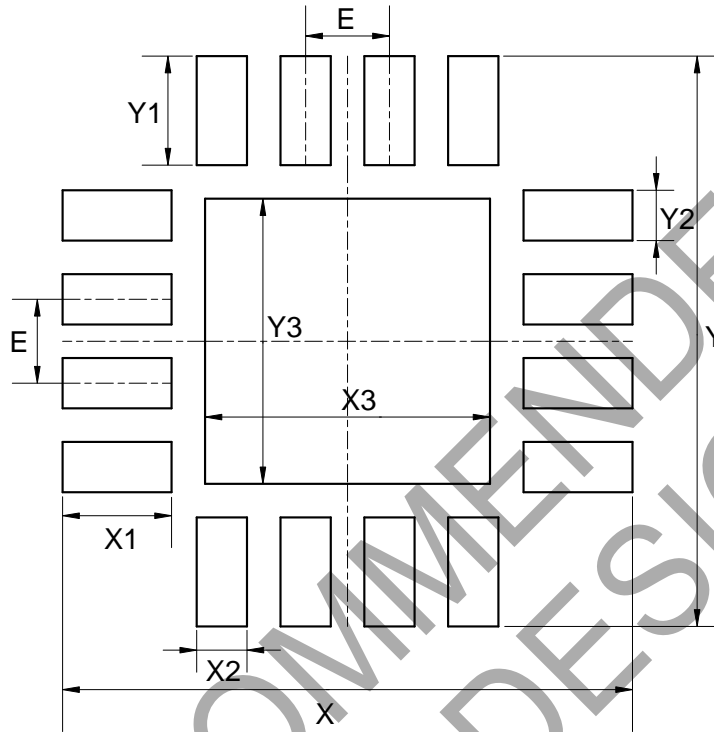

Dimensions	X=Y (mm)/(inch)	X1=Y1 (mm)/(inch)	X2=Y2 (mm)/(inch)	X3=Y3 (mm)/(inch)	E (mm)/(inch)
Value	3.400/0.134	0.650/0.026	0.300/0.012	1.700/0.067	0.500/0.020

Suggested Pad Layout (Cont.)

(2) Package Type: SOIC-14

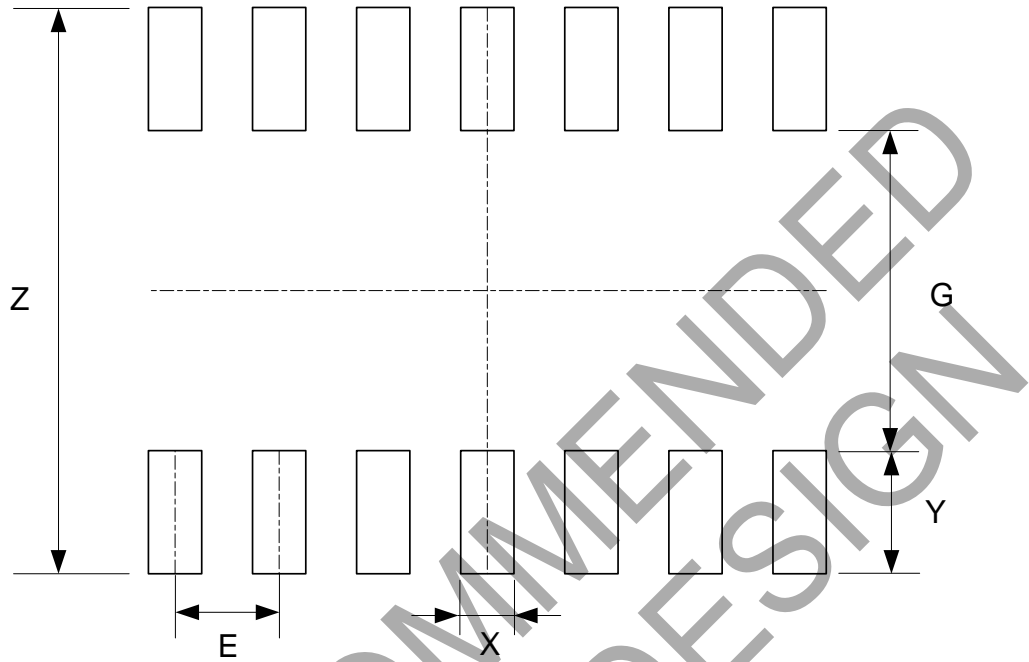

Dimensions	Z (mm)/(inch)	G (mm)/(inch)	X (mm)/(inch)	Y (mm)/(inch)	E (mm)/(inch)
Value	6.900/0.272	3.900/0.154	0.650/0.026	1.500/0.059	1.270/0.050

NOT RECOMMENDED FOR NEW DESIGN

IMPORTANT NOTICE

DIODES INCORPORATED MAKES NO WARRANTY OF ANY KIND, EXPRESS OR IMPLIED, WITH REGARDS TO THIS DOCUMENT, INCLUDING, BUT NOT LIMITED TO, THE IMPLIED WARRANTIES OF MERCHANTABILITY AND FITNESS FOR A PARTICULAR PURPOSE (AND THEIR EQUIVALENTS UNDER THE LAWS OF ANY JURISDICTION).

Diodes Incorporated and its subsidiaries reserve the right to make modifications, enhancements, improvements, corrections or other changes without further notice to this document and any product described herein. Diodes Incorporated does not assume any liability arising out of the application or use of this document or any product described herein; neither does Diodes Incorporated convey any license under its patent or trademark rights, nor the rights of others. Any Customer or user of this document or products described herein in such applications shall assume all risks of such use and will agree to hold Diodes Incorporated and all the companies whose products are represented on Diodes Incorporated website, harmless against all damages.

Diodes Incorporated does not warrant or accept any liability whatsoever in respect of any products purchased through unauthorized sales channel. Should Customers purchase or use Diodes Incorporated products for any unintended or unauthorized application, Customers shall indemnify and hold Diodes Incorporated and its representatives harmless against all claims, damages, expenses, and attorney fees arising out of, directly or indirectly, any claim of personal injury or death associated with such unintended or unauthorized application.

Products described herein may be covered by one or more United States, international or foreign patents pending. Product names and markings noted herein may also be covered by one or more United States, international or foreign trademarks.

This document is written in English but may be translated into multiple languages for reference. Only the English version of this document is the final and determinative format released by Diodes Incorporated.

LIFE SUPPORT

Diodes Incorporated products are specifically not authorized for use as critical components in life support devices or systems without the express written approval of the Chief Executive Officer of Diodes Incorporated. As used herein:

A. Life support devices or systems are devices or systems which:

1. are intended to implant into the body, or
2. support or sustain life and whose failure to perform when properly used in accordance with instructions for use provided in the labeling can be reasonably expected to result in significant injury to the user.

B. A critical component is any component in a life support device or system whose failure to perform can be reasonably expected to cause the failure of the life support device or to affect its safety or effectiveness.

Customers represent that they have all necessary expertise in the safety and regulatory ramifications of their life support devices or systems, and acknowledge and agree that they are solely responsible for all legal, regulatory and safety-related requirements concerning their products and any use of Diodes Incorporated products in such safety-critical, life support devices or systems, notwithstanding any devices- or systems-related information or support that may be provided by Diodes Incorporated. Further, Customers must fully indemnify Diodes Incorporated and its representatives against any damages arising out of the use of Diodes Incorporated products in such safety-critical, life support devices or systems.

Copyright © 2018, Diodes Incorporated

www.diodes.com