

**Note:** All part numbers are RoHS Compliant.

---

## Table of Contents—Interface Module Systems

---

Overview (Catalog Numbering Code) .....	196
<b>Interface Modules</b> .....	197-204
DIN 41612 Connector .....	198
Telco Connector .....	199
D-Sub Connector .....	200
Flat Cable Connector .....	201
DIP and ZIF Sockets .....	202
Card Edge Modules .....	203, 204
<b>Sockets</b> .....	
8 Pin Octal Socket Assemblies .....	205
11 Pin Socket Assemblies .....	206
16 Pin Miniature Socket Assemblies .....	207
14 Pin Miniature Socket Assemblies .....	208
11 Pin Square Socket Assemblies .....	209
Individual Sockets .....	210
SNAPTRACK Channel .....	211
Accessories .....	212

**Note:** All part numbers are RoHS Compliant.

**Catalog Numbering Code**



**NOTE:** Some catalog number combinations are not valid. Check appropriate catalog pages before ordering.

**Note:** All part numbers are RoHS Compliant.

## Interface Modules

### Product Facts

- n Catalog designs for many industry connectors:
  - n DIN 41612 Connector
  - n Telco Connector
  - n D-Sub Connector
  - n Flat Cable Connector (daisy chain possible)
  - n DIP & ZIF Sockets
  - n Card Edge Modules
- n Mounts on SNAPTRACK Channel which can be panel mounted or snapped to a DIN rail.
- n Terminal Block screws supplied in ready-to-wire position to save installation time.

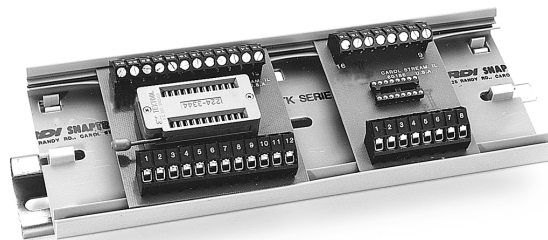

These Modules convert industry specific connectors to field wiring and are designed to supply custom solutions.

**Note:** All part numbers are RoHS Compliant.

**DIN 41612 Connector**



**Material & Finish**

**Connector:**

**Housing Material**—Thermoplastic polyester.

**Flammability**—UL94V-0

**Terminals**—Copper alloy, selective gold over nickel

**Terminal Block:**

**Housing Material**—Thermoplastic polyester

**Flammability**—UL94V-0

**Color**—Black

**Max. Operating Temperature**—120°C [248°]

**Terminals**—Bright acid-tin over copper alloy

**Screws**—#3-48, steel zinc plated

**Wire Range**—12-22 AWG

**Mounting**—2TK2 and 2TK2D Series SNAPTRACK Channel



**2M64DIN-C**

**2M64DIN**



Description	DIN Connector Mates With	Non RoHS Compliant	
		Part Number	Catalog Number
64 Position reverse male DIN (Type R), A and C filled	Type Q	3-1437684-4	2M64DIN
64 Position male DIN (Type C), A and C filled	Type B	3-1437684-5	2M64DIN-C

Description	DIN Connector Mates With	RoHS Compliant	
		Part Number	Catalog Number
64 Position reverse male DIN (Type R), A and C filled	Type Q	1776645-1	2M64DINL
64 Position male DIN (Type C), A and C filled	Type B	1776646-1	2M64DIN-CL

**Telco Connector**



**Material & Finish**

**Connector:**

**Housing Material**—Thermoplastic polyester

**Flammability**—UL94V-0

**Terminals**—Copper alloy, selective gold over nickel

**Application Data**—2M50TELS(P)  
Complies with SCSI Connections

**Terminal Block:**

**Housing Material**—Thermoplastic polyester

**Flammability**—UL94V-0

**Color**—Black

**Max. Operating Temperature**—120°C [248°]

**Terminals**—Bright acid-tin over copper alloy

**Screws**—#3-48, steel zinc plated

**Wire Range**—12-22 AWG

**Mounting**—2TK2 and 2TK2D Series SNAPTRACK Channel

No. of Positions	Dim. C	Non RoHS Compliant			
		Socket		Plug	
		Part Number	Catalog Number	Part Number	Catalog Number
36	4.30 (109.2)	2-1437684-1	2M36TELS	—	2M36TELP
50	5.70 (144.8)	3-1437684-2	2M50TELS	3-1437684-1	2M50TELP

No. of Positions	Dim. C	RoHS Compliant			
		Socket		Plug	
		Part Number	Catalog Number	Part Number	Catalog Number
36	4.30 (109.2)	1776826-1	2M36TELSL	—	2M36TELPL
50	5.70 (144.8)	1776604-1	2M50TELSL	1776643-1	2M50TELPL

## D-Sub Connector



### Material & Finish

#### Connector:

**Housing Material**—Thermoplastic polyester.

**Flammability**—UL94V-0

**Terminals**—Copper alloy, selective gold over nickel

**Shell Material**—Bright tin plated, female screw locks installed

#### Terminal Block:

**Housing Material**—Thermoplastic polyester

**Flammability**—UL94V-0

**Color**—Black

**Max. Operating Temperature**—120°C [248°]

**Terminals**—Bright acid-tin over copper alloy

**Screws**—#3-48, steel zinc plated

**Wire Range**—12-22 AWG

**Mounting**—2TK2 and 2TK2D Series SNAPTRACK Channel



No. of Positions	Dim. C	Non RoHS Compliant	
		Part Number	Catalog Number
09	1.50 (38.1)	1437684-3	2M09DSM
15	2.10 (53.3)	1437684-7	2M15DSM
25	3.10 (78.7)	1-1437684-8	2M25DSM
37	4.31 (109.5)	2-1437684-3	2M37DSM
50	5.93 (150.6)	2-1437684-9	2M50DSM

**Note:** Female D-Sub connector available as 2MxxDSF. Consult Technical Support Center.

No. of Positions	Dim. C	RoHS Compliant	
		Part Number	Catalog Number
09	1.50 (38.1)	1546693-1	2M09DSML
15	2.10 (53.3)	1546694-1	2M15DSML
25	3.10 (78.7)	1776224-1	2M25DSML
37	4.31 (109.5)	1776612-1	2M37DSML
50	5.93 (150.6)	1776613-1	2M50DSML

**Note:** Female D-Sub connector available as 2MxxDSFL. Consult Technical Support Center.

**Note:** All part numbers are RoHS Compliant.

## Flat Cable Connector

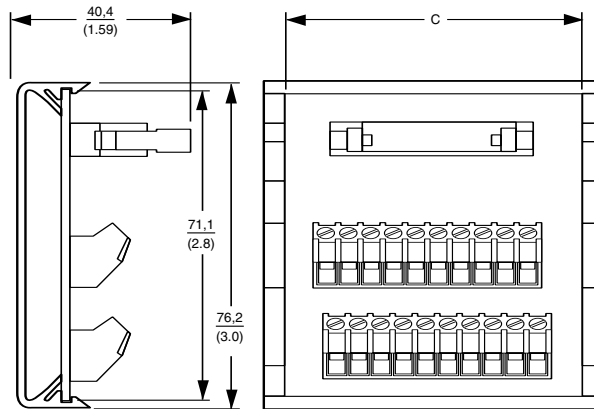

### Material & Finish

#### Connector:

**Header**—Brass, gold over nickel, UL94V-0 thermoplastic

**Connector**—Copper alloy; gold over nickel 94V-0 thermoplastic

**Wire Range**—26-30 AWG solid, 28 AWG stranded

**Maximum Current**—1 Ampere

#### Terminal Block:

**Housing Material**—Thermoplastic polyester

**Flammability**—UL94V-0

**Color**—Black

**Max. Operating Temperature**—120°C [248°]

**Terminals**—Bright acid-tin over copper alloy

**Screws**—#3-48, steel zinc plated

**Wire Range**—12-22 AWG

**Mounting**—2TK2 and 2TK2D Series SNAPTRACK Channel

No. of Positions	Dim. C	Non RoHS Compliant		RoHS Compliant	
		Part Number	Catalog Number	Part Number	Catalog Number
10	38.1 (1.50)	1437684-5	2M10FC	1776615-1	2M10FCL
14	53.3 (2.10)	1437684-6	2M14FC	1776616-1	2M14FCL
16	58.4 (2.30)	1-1437684-1	2M16FC	1776625-1	2M15FCL
20	68.6 (2.70)	1-1437684-2	2M20FC	1776626-1	2M20FCL
26	81.3 (3.20)	1-1437684-9	2M26FC	1776630-1	2M26FCL
34	104.1 (4.10)	2-1437684-0	2M34FC	1776638-1	2M34FCL
40	119.4 (4.70)	2-1437684-6	2M40FC	1776640-1	2M40FCL
50	139.7 (5.50)	3-1437684-0	2M50FC	1776642-1	2M50FCL
60	165.1 (6.50)	3-1437684-3	2M60FC	1776644-1	2M60FCL
64	170.2 (6.70)	3-1437684-6	2M64FC	1776647-1	2M64FCL

**Note:** Strain relief connector supplied with all assemblies.

**Note:** All part numbers are RoHS Compliant.

**DIP and ZIF Sockets**



**Material & Finish**

**Connector:**

**Terminal**—Contacts copper alloy, gold over nickel

**Terminal Block:**

**Housing Material**—Thermoplastic polyester

**Flammability**—UL94V-0

**Color**—Black

**Max. Operating Temperature**—120°C [248°]

**Terminals**—Bright acid-tin over copper alloy

**Screws**—#3-48, steel zinc plated

**Wire Range**—12-22 AWG

**Mounting**—2TK2 and 2TK2D Series SNAPTRACK Channel

2M16DP

2M16DPZ



No. of Positions	Socket Pin Spacing Grid Size Dimensions			Non RoHS Compliant	
	B	C	D	Part Number	Catalog Number
<b>DIP Socket to Screw Terminal</b>					
8	1.05 (26.7)	1.20 (30.5)	.100 x .300 (2.5 x 7.6)	1437684-2	2M08DP
16	1.05 (26.7)	2.00 (50.8)	.100 x .300 (2.5 x 7.6)	1437684-8	2M16DP
24	1.05 (26.7)	2.80 (71.1)	.100 x .600 (2.5 x 15.2)	1-1437684-4	2M24DP
40	1.05 (26.7)	4.40 (111.8)	.100 x .600 (2.5 x 15.2)	2-1437684-4	2M40DP
<b>ZIF Socket to Screw Terminal</b>					
16	1.40 (35.6)	2.00 (50.8)	—	1-1437684-0	2M16DPZ
24	1.40 (35.6)	2.80 (71.1)	—	1-1437684-5	2M24DPZ
40	1.40 (35.6)	4.40 (111.8)	—	2-1437684-5	2M40DPZ

**Note:** ZIF denotes zero insertion force.

No. of Positions	Socket Pin Spacing Grid Size Dimensions			RoHS Compliant	
	B	C	D	Part Number	Catalog Number
<b>DIP Socket to Screw Terminal</b>					
8	1.05 (26.7)	1.20 (30.5)	.100 x .300 (2.5 x 7.6)	1776599-1	2M08DPL
16	1.05 (26.7)	2.00 (50.8)	.100 x .300 (2.5 x 7.6)	1776600-1	2M16DPL
24	1.05 (26.7)	2.80 (71.1)	.100 x .600 (2.5 x 15.2)	1776602-1	2M24DPL
40	1.05 (26.7)	4.40 (111.8)	.100 x .600 (2.5 x 15.2)	1776603-1	2M40DPL
<b>ZIF Socket to Screw Terminal</b>					
16	1.40 (35.6)	2.00 (50.8)	—	1776624-1	2M16DPZL
24	1.40 (35.6)	2.80 (71.1)	—	1776628-1	2M24DPZL
40	1.40 (35.6)	4.40 (111.8)	—	1776639-1	2M40DPZL

**Note:** ZIF denotes zero insertion force.



## Card Edge Modules

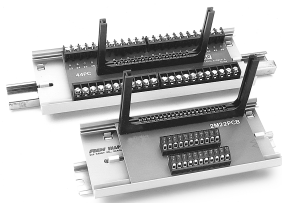

### Material & Finish

**Connector**—Gold over nickel contact with card guide—accepts up to 4.5" [114.30] wide board. 0.156" [3.96] pitch (terminal spacing)

### 22PCB, 44PC

#### Terminal Block Tri-Barrier

**Terminals**—Bright acid tin over copper alloy

**Screws**—#4-40 steel zinc with clear chromate with captive wire clamping plate

**Wire Range**—14-22 AWG

**Mounting**—Fits TK2 & TK2D Series

### 2M22PCB, 2M44PC

#### Terminal Block:

**Housing Material**—Thermoplastic polyester

**Flammability**—UL94V-0

**Color**—Black

**Max. Operating Temperature**—120°C [248°]

**Terminals**—Bright acid-tin over copper alloy

**Screws**—#3-48, steel zinc plated

**Wire Range**—12-22 AWG

**Mounting**—2TK2 and 2TK2D Series SNAPTRACK Channel

Description	Non RoHS Compliant	
	Part Number	Catalog Number
For single-sided notched cards. Numbered Terminals 1-22 and A-Z	1437684-1	22PCB
For double-sided, notched cards. Numbered terminals A-Z, 1-22 and 1-44	3-1437684-7	44PC
Similar to 22PCB but all terminal positions are on one side of board	1-1437684-3	2M22PCB
Similar to 44PC but all terminal positions are on one side of board	2-1437684-7	2M44PC

Description	RoHS Compliant	
	Part Number	Catalog Number
For single-sided notched cards. Numbered Terminals 1-22 and A-Z	1776614-1	22PCBL
For double-sided, notched cards. Numbered terminals A-Z, 1-22 and 1-44	1776649-1	44PCL
Similar to 22PCBL but all terminal positions are on one side of board	1776627-1	2M22PCBL
Similar to 44PCL but all terminal positions are on one side of board	1776641-1	2M44PCL

**Note:** All part numbers are RoHS Compliant.

**Card Edge Modules (Continued)**

**2M22PCB and 2M44PC**



**22PCB and 44PC**

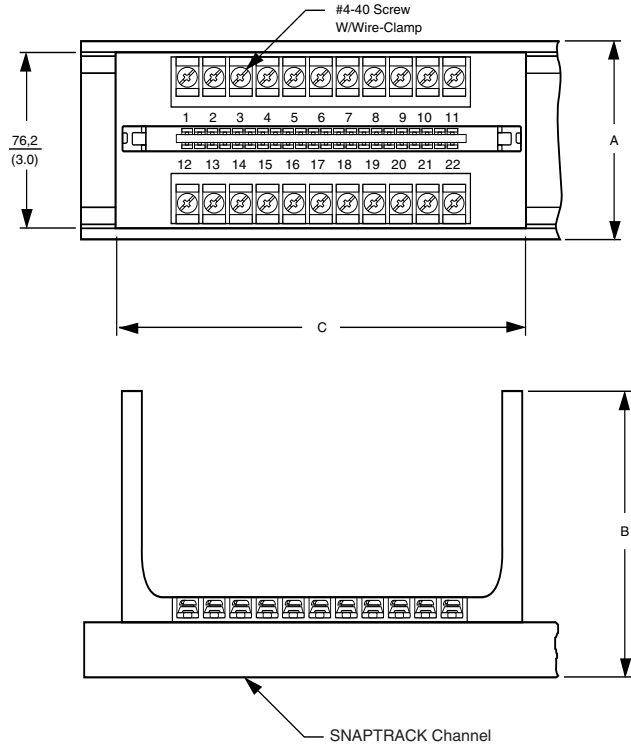

No. of Positions	Track Size	Dimensions				Non RoHS Compliant	
		A Ref.	B	C	PC Card Width	Part Number	Catalog Number
22	TK(2D)	80.3 (3.16)	90.4 (3.56)	127.0 (5.00)	114.3 (4.5)	1437684-1	22PCB
	2TK(2D)	69.9 (2.75)	90.4 (3.56)	127.0 (5.00)	114.3 (4.5)	1-1437684-3	2M22PCB
44	TK (2D)	80.3 (3.16)	90.4 (3.56)	190.5 (7.50)	114.3 (4.5)	3-1437684-7	44PC
	2TK(2D)	69.9 (2.75)	90.4 (3.56)	127.0 (5.00)	114.3 (4.5)	2-1437684-7	2M44PC

No. of Positions	Track Size	Dimensions				RoHS Compliant	
		A Ref.	B	C	PC Card Width	Part Number	Catalog Number
22	TK(2D)	80.3 (3.16)	90.4 (3.56)	127.0 (5.00)	114.3 (4.5)	1776614-1	22PCBL
	2TK(2D)	69.9 (2.75)	90.4 (3.56)	127.0 (5.00)	114.3 (4.5)	1776627-1	2M22PCBL
44	TK (2D)	80.3 (3.16)	90.4 (3.56)	190.5 (7.50)	114.3 (4.5)	1776649-1	44PCL
	2TK(2D)	69.9 (2.75)	90.4 (3.56)	127.0 (5.00)	114.3 (4.5)	1776641-1	2M44PCL

**Note:** All part numbers are RoHS Compliant.

## 8 Pin Octal Socket Assemblies

### SM8 and 608BR



### 318BR, 208BR, 608BR, 218BR



### Material & Finish

#### 208BR, 218BR, 318BR

- Rating**—10A, 150V
- Screws**—#4-40 zinc plated with clear chromate, with wire clamp
- Wire Range**—4-22 AWG
- Bails**—RB1, TB1(see accessory page 212)

#### 608BR

- Rating**—10A, 250V
- Screws**—#6-32 zinc plated with wire clamp
- Wire Range**—12-22 AWG
- Bails**—RB1, TB1(see accessory page 212)

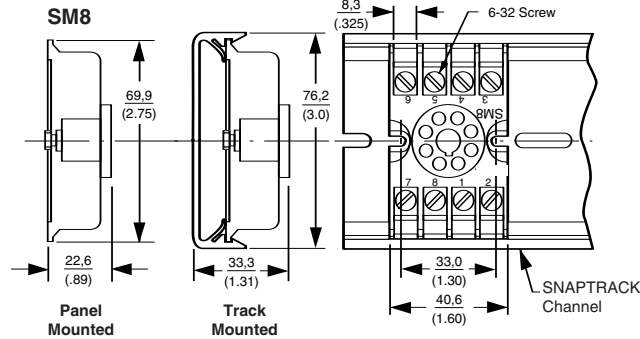

#### SM8

- Rating**—10A, 300V
- Material**—ABS
- Flammability**—UL94V-0
- Contacts**—Tin over copper-plated phosphor-bronze.
- Screws**—#6-32 zinc plated with clear chromate with wire clamping plates
- Wire Range**—12-22 AWG
- Max. Operating Temperature**—60°C [140°F]

Dimensions				Non RoHS Compliant		RoHS Compliant
A	B	C	D	Part Number	Catalog Number	SNAPTRACK® Channel
3.16 (80.3)	1.13 (28.7)	2.00 (50.8)	1.69 (42.9)	1437683-6	208BR	TK2(D)
3.16 (80.3)	1.13 (28.7)	1.50 (38.1)	—	1-1437683-0	218BR	TK2(D)
2.90 (73.7)	1.13 (28.7)	1.50 (38.1)	—	1-1437683-4	318BR	2TK2(D)
3.16 (80.3)	1.13 (28.7)	2.00 (50.8)	1.69 (42.9)	1-1437683-6	608BR	TK2(D)
—	—	—	—	2-1437683-8	SM8	2TK2

**Note:** SM8 is a molded product with mounting holes provided.

### Related Product Data

Sockets on this page will fit the following relays:

- Tyco Electronics Relay Series**—SCB, SCC, SCE, SRC, SSC, SST, VMA
- P&B Relay Series**—CB, CD, CG, CH, CK, CR, CN1, CNS, CS, KRP/KRPA, S89R\_P, 155
- SCHRACK Relay Series**—MT

For more information on Relays request Catalog 1308242.

Dimensions				RoHS Compliant		
A	B	C	D	Part Number	Catalog Number	SNAPTRACK® Channel
3.16 (80.3)	1.13 (28.7)	2.00 (50.8)	1.69 (42.9)	1776633-1	208BRL	TK2(D)
3.16 (80.3)	1.13 (28.7)	1.50 (38.1)	—	1776617-1	218BRL	TK2(D)
2.90 (73.7)	1.13 (28.7)	1.50 (38.1)	—	1776619-1	318BRL	2TK2(D)
3.16 (80.3)	1.13 (28.7)	2.00 (50.8)	1.69 (42.9)	1776620-1	608BRL	TK2(D)
—	—	—	—	2-1437683-8	SM8	2TK2

**Note:** SM8 is a molded product with mounting holes provided.

**Note:** All part numbers are RoHS Compliant.

## 11 Pin Socket Assemblies

### SM11 and 611BR



### Material & Finish

#### 211BR, 311BR

**Rating**—10A, 150V  
**Screws**—#4-40 zinc plated with clear chromate with wire clamps  
**Wire Range**—14-22 AWG  
**Bails**—RB1, TB1 (see accessory page 212)

#### 611BR

**Rating**—10A, 250V  
**Screws**—#6-32 zinc plated with clear chromate, with wire clamps.  
**Wire Range**—12-22 AWG  
**Bails**—RB1, TB1 (see accessory page 212)



#### SM11

**Rating**—10A, 300V  
**Material**—ABS  
**Flammability**—UL94V-0  
**Max. Operating Temperature**—60°C [140°F]  
**Contacts**—Tin over copper-plated phosphor-bronze.  
**Screws**—#6-32 zinc plated with clear chromate, with wire clamps  
**Wire Range**—12-22 AWG  
**Bails**—RB5 (see accessory page 212)

Dimensions				Non RoHS Compliant		RoHS Compliant
A	B	C	D	Part Number	Catalog Number	SNAPTRACK® Channel
3.16 (80.3)	1.13 (28.7)	2.13 (54.1)	1.18 (46.0)	1437683-7	211BR	TK2(D)
2.90 (73.7)	1.13 (28.7)	2.13 (54.1)	1.18 (46.0)	1-1437683-2	311BR	2TK2(D)
3.16 (80.3)	1.13 (28.7)	2.75 (69.9)	2.30 (60.5)	1-1437683-8	611BR	TK2(D)
—	—	—	—	2-1437683-7	SM11	2TK

**Note:** SM11 is a molded product with mounting holes provided.

### Related Product Data

Sockets on this page will fit the following relays:

- Tyco Electronics Relay Series**—SCF, SSC, SCB, SCC, SST
- P&B Relay Series**—CB, CD, CG, CH, CK, CNM5, CNS, CNT, KBP, KRP/KRPA, 155
- SCHRACK Relay Series**—MT

For more information on Relays request Catalog 1308242.

Dimensions				RoHS Compliant		
A	B	C	D	Part Number	Catalog Number	SNAPTRACK® Channel
3.16 (80.3)	1.13 (28.7)	2.13 (54.1)	1.18 (46.0)	1776634-1	211BRL	TK2(D)
2.90 (73.7)	1.13 (28.7)	2.13 (54.1)	1.18 (46.0)	1776827-1	311BRL	2TK2(D)
3.16 (80.3)	1.13 (28.7)	2.75 (69.9)	2.30 (60.5)	1776622-1	611BRL	TK2(D)
—	—	—	—	2-1437683-7	SM11	2TK

**Note:** SM11 is a molded product with mounting holes provided.



**Note:** All part numbers are RoHS Compliant.

**16 Pin Miniature Socket Assemblies**

**204BS**



**Material & Finish**

**Rating**—5A,150V

**Max. Operating Temperature**—105°C

**Screws**—#4-40 zinc plated with captive wire clamping plate

**Wire Range**—14-22 AWG

**Bails**—204BS-RB4 (see accessory page 212)

**Related Product Data**

Sockets on this page will fit the following relays:

**P&B Relay Series**—R10

For more information on Relays request Catalog 1308242.



Dimensions				Fits Relay	Non RoHS Compliant		RoHS Compliant
A	B	C	D		Part Number	Catalog Number	SNAPTRACK® Channel
3.16 (80.3)	1.00 (25.4)	1.50 (38.1)	—	2PDT	1437683-4	202BS	TK2(D)
3.16 (80.3)	1.00 (25.4)	2.50 (63.5)	2.13 (54.1)	4PDT	1437683-5	204BS	TK2

**Note:** Holes provided for bails, see page 212.

Dimensions				Fits Relay	RoHS Compliant		
A	B	C	D		Part Number	Catalog Number	SNAPTRACK® Channel
3.16 (80.3)	1.00 (25.4)	1.50 (38.1)	—	2PDT	1776631-1	202BSL	TK2(D)
3.16 (80.3)	1.00 (25.4)	2.50 (63.5)	2.13 (54.1)	4PDT	1776632-1	204BSL	TK2

**Note:** Holes provided for bails, see page 212.

**Note:** All part numbers are RoHS Compliant.

## 14 Pin Miniature Socket Assemblies

### 214BS



#### Material & Finish

**Ratings**—5A,150V

#### 214BS, 314BS

**Screws**—#4-40 zinc plated with clear chromate, with captive wire clamping plate

**Wire Range**—14-22 AWG

#### 614BS

**Screws**—#6-32 zinc plated with clear chromate, with wire clamp

**Wire Range**—12-22 AWG

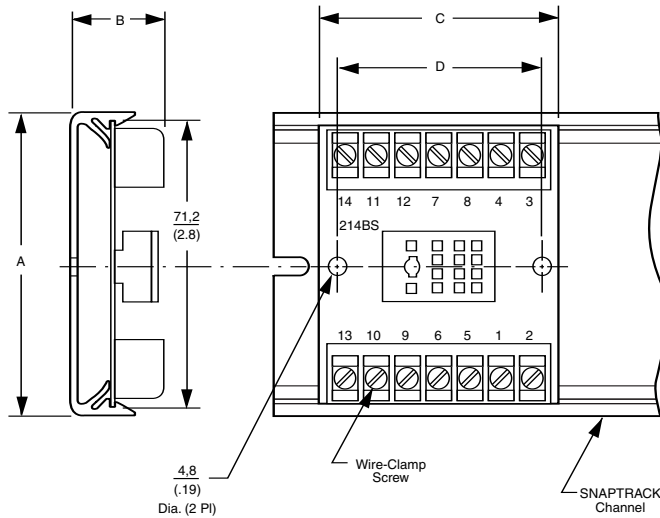

#### Related Product Data

Sockets on this page will fit the following relays:

**P&B Relay Series**—KHAU/KHU, 156, 158

**SCHRACK Relay Series**—PT

For more information on Relays request Catalog 1308242.

Dimensions				Fits Relay	Non RoHS Compliant		RoHS Compliant
A	B	C	D		Part Number	Catalog Number	SNAPTRACK® Channel
3.16 (80.3)	1.06 (26.9)	2.50 (63.5)	2.13 (54.0)	4PDT	1437683-9	214BS	TK2(D)
2.90 (73.7)	1.06 (26.9)	2.50 (63.5)	—	4PDT	1-1437683-3	314BS	2TK2(D)
3.16 (80.3)	1.13 (28.7)	2.75 (69.9)	—	4PDT	2-1437683-0	614BS	TK2(D)

**Note:** Holes provided for bails, see page 212.

Dimensions				Fits Relay	RoHS Compliant		
A	B	C	D		Part Number	Catalog Number	SNAPTRACK® Channel
3.16 (80.3)	1.06 (26.9)	2.50 (63.5)	2.13 (54.0)	4PDT	1776636-1	214BSL	TK2(D)
2.90 (73.7)	1.06 (26.9)	2.50 (63.5)	—	4PDT	1776618-1	314BSL	2TK2(D)
3.16 (80.3)	1.13 (28.7)	2.75 (69.9)	—	4PDT	1776637-1	614BSL	TK2(D)

**Note:** Holes provided for bails, see page 212.



**Note:** All part numbers are RoHS Compliant.

## 11 Pin Square Socket Assemblies

### 608BS

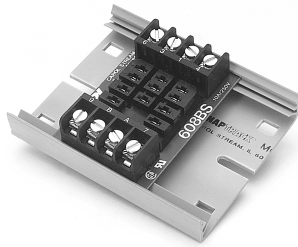

#### Material & Finish

#### 608BS, 611BS

**Rating**—10A, 250V

**Screws**—#6-32 zinc plated with clear chromate, with wire clamp

**Wire Range**—12-22 AWG

#### 211BS

**Rating**—10A, 150V

**Screws**—#4-40 zinc plated with clear chromate, with wire clamp

**Wire Range**—14-22 AWG

#### Related Product Data

Sockets on this page will fit the following relays:

**Tyco Electronics Relay Series**—STA

**P&B Relay Series**—CL, CU, KUPE, KUIP, KUMP, KUGP, KUL, KUP, SDAS-01, 157

**SCHRACK Relay Series**—RM2/3/7, RM5/6

For more information on Relays request Catalog 1308242.

Dimensions			Fits Relay	Non RoHS Compliant		RoHS Compliant
A	B	C		Part Number	Catalog Number	SNAPTRACK® Channel
3.16 (80.3)	1.06 (26.9)	2.13 (54.1)	SPDT, DPDT	1437683-8	211BS	TK2(D)
3.16 (80.3)	1.13 (28.7)	2.00 (50.8)	3PDT	1-1437683-7	608BS	TK2(D)
3.16 (80.3)	1.13 (28.7)	2.50 (63.5)	DPDT, 3PDT	1-1437683-9	611BS	TK2(D)

Dimensions			Fits Relay	RoHS Compliant		
A	B	C		Part Number	Catalog Number	SNAPTRACK® Channel
3.16 (80.3)	1.06 (26.9)	2.13 (54.1)	SPDT, DPDT	1776630-1	211BSL	TK2(D)
3.16 (80.3)	1.13 (28.7)	2.00 (50.8)	3PDT	1776621-1	608BSL	TK2(D)
3.16 (80.3)	1.13 (28.7)	2.50 (63.5)	DPDT, 3PDT	1776623-1	611BSL	TK2(D)

211BS ONLY



LR49571



E58648

**Note:** All part numbers are RoHS Compliant.

## Individual Sockets

### Material & Finish

- Ratings**—10A/300V
- Housing Material**—Thermoplastic polyester
- Flammability**—UL94V-0
- Color**—Black
- Max. Operating Temperature**—130°C [266°F]
- Contacts**—Phosphor-bronze, bright acid-tin plated

### Related Product Data

Sockets 8S and 11S will fit the following relays:

- AGASTAT Relay Series**—STA
- P&B/MIDTEX Relay Series**—CL, CU, KUJEP, KUIP, KUMP, KUGP, KUL, KUP, SDAS-01, 157

**SCHRACK Relay Series**—RM2/3/7, RM5/6

Socket 21S will fit the following relays:

- P&B Relay Series**—R10
- Socket 14S will fit the following relays:
- P&B/MIDTEX Relay Series**—KHAU/KHU, 156, 158

**SCHRACK Relay Series**—PT

Socket 8R will fit the following relays:

- AGASTAT Relay Series**—SCB, SCC, SCE, SRC, SSC, SST, VMA

**P&B/MIDTEX Relay Series**—CB, CD, CG, CH, CK, CR, CN1, CNS, CS, KRP/KRPA, S89R\_\_P, 155

**SCHRACK Relay Series**—MT

Socket 11R will fit the following relays:

- Tyco Electronics Relay Series**—SCF, SSC, SCB, SCC, SST
- P&B Relay Series**—CB, CD, CG, CH, CK, CNM5, CNS, CNT, KBP, KRP/KRPA, 155

**SCHRACK Relay Series**—MT

For more information on Relays request Catalog 1308242.

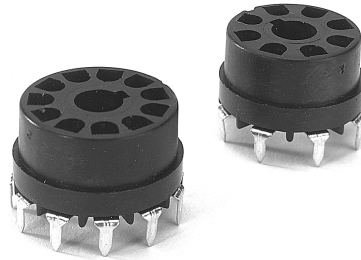

11R, 8R

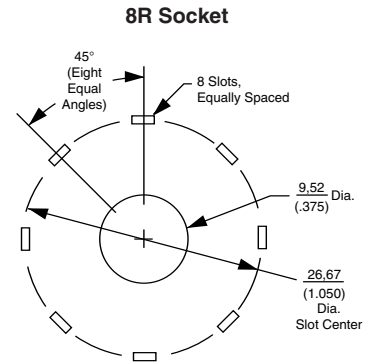

8R Socket

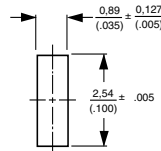



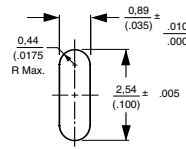

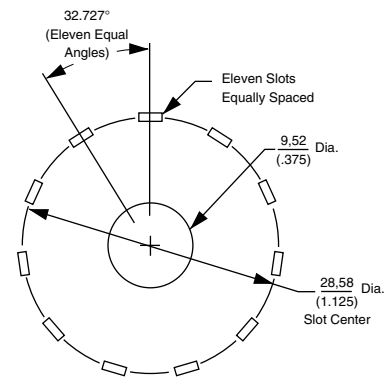

Punched Slot Detail



Routed Slot Detail



11R Socket

Socket Style	Fits Relays	Part Number	Catalog Number
	2PDT	2-1437683-2	8S-SOCKET
	3PDT	1437661-1	11S-SOCKET
	2PDT	1-1437683-1	21S-SOCKET
	4PDT	1437683-3	14S-SOCKET
	8 pin octal	2-1437683-1	8R-SOCKET
	11 pin	1437683-1	11R-SOCKET



E58648



**Note:** All part numbers are RoHS Compliant.

**SNAPTRACK Channel**



SNAPTRACK Channel can be mounted on standard DIN rails or A Series rail when used with TKAD. (Rails not included.)

SNAPTRACK Channel is a nonconductive, rigid extruded PVC chassis used for mounting socket assemblies and custom circuit boards. Available in a variety of fixed widths, including a split-apart version for wider PCB applications, SNAPTRACK Channel mounts to panels quickly with rivets or screws.

Printed circuit boards are simply snapped-in from the front, then held securely via intergral ribs which also serve as shock absorbers when the PCB is flexed. SNAPTRACK Channel permits easy, convenient PCB removal for field service. Slots on 2-inch centers are provided for fast, easy installation using either plastic rivets or other hardware. Double-faced tape may also be used effectively.

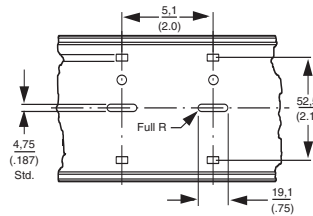

**TK2D, 2TK2D, 3TK2D, 6TK2D Panel Mount, or use with TKAD to Mount on DIN Rail and A Series Rail**

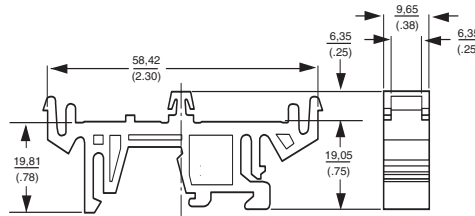

**TKAD use with SNAPTRACK Channel to Mount on DIN Rail or A Series Rail**

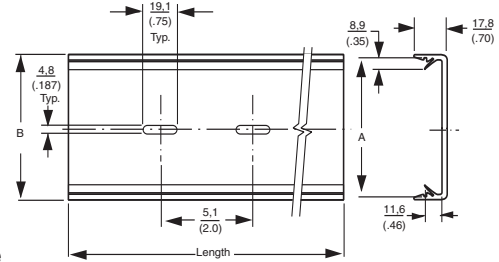

**TK2, 3TK2, 8TK2, 2TK2, 6TK2 Panel Mount**

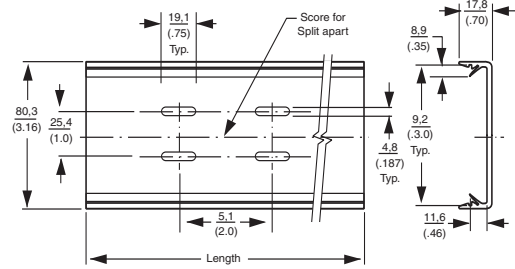

**4TK2 Panel Mount**

Track Catalog No.*	Dimensions	
	A P.C. Board Width	B Overall Track Width
8TK2-xx	55.5 (2.187)	58.4 (2.3)
2TK2-xx	69.9 (2.75)	73.7 (2.9)
2TK2D-xx	69.9 (2.75)	73.7 (2.9)
TK2-xx-AG	76.2 (3.0)	78.7 (3.1)
TK2D-xx-AG	76.2 (3.0)	78.7 (3.1)
3TK2-xx	82.6 (3.25)	86.4 (3.40)
3TK2D-xx	82.6 (3.25)	86.4 (3.40)
6TK2-xx	101.6 (4.0)	105.4 (4.15)
6TK2D-xx	101.6 (4.0)	105.4 (4.15)
4TK2-xx	SPLIT-APART	—

**Note:** Standard lengths are 3", 6", 12", 24", and 48". Custom lengths are available.

\*Replace xx with track length.



**Note:** All part numbers are RoHS Compliant.

**Accessories**

**Track Rivets**

Plastic Track Rivet offers a low cost way to mount SNAPTRACK Channel. Requires 3/16" diameter hole in panels up to .125" thick. Cat. No. TR-1



**TR-1 Track Rivet**  
1437645-6

**Bails (Tie Downs)**

Helps prevent relays and timers from vibrating out of sockets. RB1-AG and TB1, for general purpose relays and timers, feature adjustable height; mount on PC board with plastic mounting rivets (2) furnished. New economy RB5 spring bails fits most general purpose relays and timers. RB4 clip to miniature sockets. Stainless steel wire.

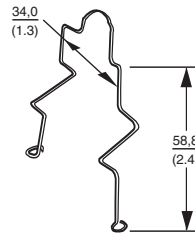

**RB1-AG Relay Bail**  
2-1437683-3

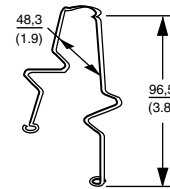

**TB1 Timer Bail**  
3-1437683-0

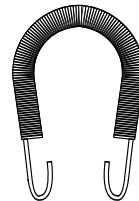

**RB5-AG Universal Bail**  
2-1437683-6

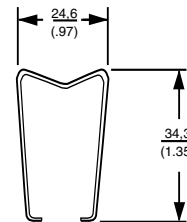

**RB4-AG**  
2-1437683-5