

28 V, 150 mA Voltage Regulator with Stand-by Mode

FEATURES

- Operating Voltage Range 2.0 V – 28.0 V
- Output Voltage Range from 2.0 V to 12.0 V with 0.1 V increments (B series) or 2.0 V – 23 V with external resistors (C series)
- Output Voltage Accuracy $\pm 2\%$
- Dropout Voltage 300 mV @ $I_{OUT} = 20$ mA
- Temperature Stability ± 30 ppm/ $^{\circ}$ C
- Low Power Consumption of 5 μ A at $V_{OUT} = 5.0$ V
- Output Current up to 150 mA (200 mA limit) at $V_{IN} = V_{OUT} + 3$ V
- Standby Current less than 0.1 μ A typical
- Power Supply Ripple Rejection 30 dB at 1 kHz
- Current Limit and Short Circuit Protection
- Low ESR Ceramic Capacitor compatible
- ON/OFF switch,
- Thermal shutdown
- Operating Ambient Temperature - 40 + 85 $^{\circ}$ C
- Packages : SOT-25, SOT- 89, SOT-89-5, SOP-8FD, USP-6C, SOT-223, and TO-252
- EU RoHS Compliant, Pb Free

APPLICATIONS

- Mobile phones
- Car Audio and Navigation Systems
- Cameras, VCRs
- Various portable equipment

DESCRIPTION

The IXD1216 is positive voltage regulator with operation voltage up to 28V, manufactured by CMOS process.

The IC consists of a voltage reference, an error amplifier, a current limiter, a thermal protection, a phase compensation circuit, and a driver transistor.

The output voltage is selectable in 0.1 V increments within the range from 2.0 V to 12 V for B and D series and from 2.0 V to 23 V with external resistors for C series. High precision output voltage achieved by laser trimming technology.

The IXD1216 is stable with low ESR ceramic output capacitor (C_L). The over current protection circuit and the thermal shutdown are built-in. These two protection circuits operate when the output current reaches current limit level or the junction temperature reaches temperature limit.

The Chip Enable (CE) function allows set IXD1216 into standby mode, reducing current consumption to less than 0.1 μ A typically.

The IXD1216 is available in SOT-25, SOT-89, SOT-89-5, SOP-8FD, USP-6C, SOT-223, and TO-252 packages.

TYPICAL APPLICATION CIRCUIT

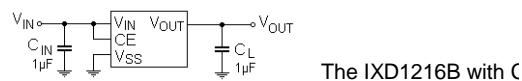

The IXD1216B with C

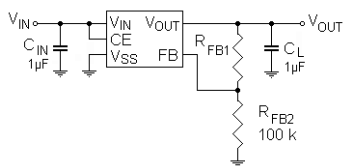

The IXD1216C series

TYPICAL PERFORMANCE CHARACTERISTIC

Output Voltage vs. Input Voltage (IXD1216B/D502)

$C_{IN} = C_L = 1 \mu F, T_a = 25^{\circ}C,$

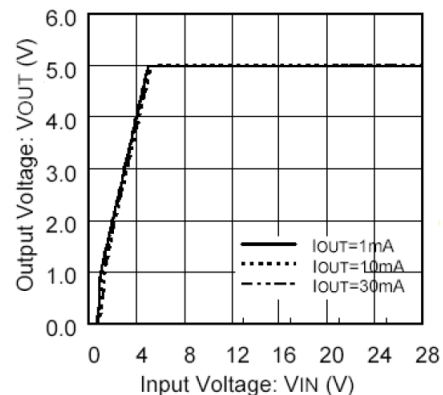

ABSOLUTE MAXIMUM RATINGS

PARAMETER		SYMBOL	RATINGS	UNITS
Input Voltage		V_{IN}	- 0.3 ~ +30	V
Output Current		I_{OUT}	300 ¹⁾	mA
Output Voltage		V_{OUT}	- 0.3 ~ $V_{IN} + 0.3$ or +30 ²⁾	V
CE Input Voltage (IXD1216B/C version only)		V_{CE}	- 0.3 ~ $V_{IN} + 0.3$ or +30 ²⁾	V
FB Voltage (IXD1216C version only)		V_{FB}	- 0.3 ~ $V_{IN} + 0.3$ or +30 ²⁾	V
Power Dissipation ²⁾	SOT-25	P_D	250	mW
			600 (PCB mounted)	
	SOT-89		500	
			1000 (PCB mounted)	
	SOT-89-5		500	
			1300 (PCB mounted)	
	USP-6C		120	
			1000 (PCB mounted)	
	SOT223		300	
1500 (PCB mounted)				
TO-252	500			
	1800 (PCB mounted)			
SOP-8FD	300			
	1500 (PCB mounted)			
Operating Temperature Range		T_{OPR}	- 40 ~ + 85	°C
Storage Temperature Range		T_{STG}	- 55 ~ +125	°C

All voltages are in respect to V_{SS}

- 1) $I_{OUT} \leq Pd / (V_{IN} - V_{OUT})$
- 2) The lowest value between $V_{IN} + 0.3$ and 30 V
- 3) This is a reference data taken by using the test board. Please refer to page 24 to 30 for details

ELECTRICAL OPERATING CHARACTERISTICS

Ta = 25 °C

PARAMETER	SYMBOL	CONDITIONS	MIN.	TYP.	MAX.	UNIT	CIRCUIT
Input Voltage	V _{IN}		2.0		28.0	V	①
Output Voltage	V _{OUT(E)} ¹⁾	V _{CE} = V _{IN} , I _{OUT} = 20 mA ⁵⁾	E-0			V	①
		V _{FB} = V _{CE} = V _{IN} = 4.0 V, I _{OUT} = 20 mA ⁶⁾	2% accuracy	1.96	2.00		
Maximum Output Current	I _{OUT_MAX}	V _{CE} = V _{IN} = V _{OUT(T)} + 3 V	V _{OUT(T)} ≥ 3 V	150		mA	①
			V _{OUT(T)} < 3 V	100			
Load Regulation	ΔV _{OUT}	V _{CE} = V _{IN} , 1 mA ≤ I _{OUT} ≤ 50 mA	2.0 V ≤ V _{OUT(T)} ≤ 7.0 V	50	90	mV	①
			7.1 V ≤ V _{OUT(T)} ≤ 12.0 V	110	140		
Dropout Voltage ²⁾	V _{DIF1}	V _{CE} = V _{IN} , I _{OUT} = 20 mA	E-1 ⁴⁾			mV	①
			V _{CE} = V _{IN} , V _{FB} = V _{OUT} , I _{OUT} = 20 mA ⁶⁾	450	600		
	V _{DIF2}	V _{CE} = V _{IN} , I _{OUT} = 100 mA	E-2 ⁴⁾				
		V _{CE} = V _{IN} , V _{FB} = V _{OUT} , I _{OUT} = 100 mA ⁶⁾	1900	2600			
Supply Current	I _{SS}	V _{CE} = V _{IN}	1	5	9	μA	②
Standby Current	I _{STB}	V _{CE} = 0 V		0.01	0.10	μA	②
Line Regulation	$\frac{\Delta V_{OUT}}{V_{OUT} * \Delta V_{IN}}$	V _{OUT(T)} + 2 V ≤ V _{IN} ≤ 28 V, V _{CE} = V _{IN}	I _{OUT} = 5 mA	0.05	0.10	%V	①
			I _{OUT} = 13 mA	0.15	0.30		
Output Voltage Temperature Characteristics	$\frac{\Delta V_{OUT}}{V_{OUT} * \Delta T_{OPR}}$	V _{CE} = V _{IN} , I _{OUT} = 30 mA - 40 °C ≤ T _{OPR} ≤ 85 °C		± 100		ppm/°C	①
Power Supply Rejection Ratio	PSRR	V _{CE} = V _{IN} , I _{OUT} = 20 mA, f = 1 kHz V _{IN} = (V _{OUT(T)} + 2) V _{DC} + 0.5 V p-p _{AC}		30		dB	③
Short Circuit Current	I _{SHORT}	V _{CE} = V _{IN} , V _{IN} = V _{OUT(T)} + 2 V		30		mA	①
Thermal Shutdown Detect Temperature	T _{TSD}	Junction Temperature		150		°C	
Thermal Shutdown Hysteresis	T _{HYS}			25		°C	
CE "H" Level Voltage ⁵⁾	V _{CEH}		1.1		V _{IN}	V	①
CE "L" Level Voltage ⁵⁾	V _{CEL}		0		0.35	V	①
CE "H" Level Current ⁵⁾	I _{CEH}	V _{CE} = V _{IN} = 28.0 V	-0.1		0.1	μA	①
CE "L" Level Current ⁵⁾	I _{CEL}	V _{IN} = 28.0 V, V _{CE} = V _{SS}	-0.1		0.1	μA	①
FB Pin Resistance	R _{FB}	V _{FB} = V _{IN} = V _{OUT} = 5.0 V, V _{CE} = V _{SS}	1.70	4.10	6.30	MΩ	

NOTE:

Unless otherwise stated, V_{IN} = V_{CE} = V_{OUT(T)} + 2.0 V

- 1) V_{OUT(T)} is Nominal output voltage and V_{OUT(E)} is Effective output voltage, (i.e. the output voltage when "V_{OUT(T)} + 1.0V" is provided at the V_{IN} pin, while maintaining a certain I_{OUT} value).
- 2) V_{DIF} = {V_{IN} - V_{OUT}}, where V_{IN1} is the input voltage when V_{OUT} = 0.98 V_{OUT(T)} appears, while input voltage gradually decreases
- 3) Refer to the Table "Voltage Chart, Output Voltage"
- 4) Refer to the Table "Voltage Chart, Dropout Voltage"
- 5) IXD1216B/C versions only
- 6) IXD1216C version only

ELECTRICAL OPERATING CHARACTERISTICS (CONTINUED)

Voltage Chart

Ta = 25°C

SYMBOL	E-0				E-1		E-2	
	OUTPUT VOLTAGE, V				DROPOUT VOLTAGE, mV		DROPOUT VOLTAGE, mV	
	V _{OUT(E)}				I _{OUT} = 20 mA		I _{OUT} = 100 mA	
	V _{OUT(T)} (V)	2% accuracy		1% accuracy		Vdif1		Vdif2
MIN.		MAX.	MIN.	MAX.	TYP.	MAX.	TYP.	MAX.
2.0	1.960	2.040	1.980	2.020	450	600	1900	2600
2.1	2.058	2.142	2.079	2.121	450	600	1900	2600
2.2	2.156	2.244	2.178	2.222	390	520	1700	2200
2.3	2.254	2.346	2.277	2.323	390	520	1700	2200
2.4	2.352	2.448	2.376	2.424	390	520	1700	2200
2.5	2.450	2.550	2.475	2.525	310	450	1500	1900
2.6	2.548	2.652	2.574	2.626	310	450	1500	1900
2.7	2.646	2.754	2.673	2.727	310	450	1500	1900
2.8	2.744	2.856	2.772	2.828	310	450	1500	1900
2.9	2.842	2.958	2.871	2.929	310	450	1500	1900
3.0	2.940	3.060	2.970	3.030	260	360	1300	1700
3.1	3.038	3.162	3.069	3.131	260	360	1300	1700
3.2	3.136	3.264	3.168	3.232	260	360	1300	1700
3.3	3.234	3.366	3.267	3.333	260	360	1300	1700
3.4	3.332	3.468	3.366	3.434	260	360	1300	1700
3.5	3.430	3.570	3.465	3.535	260	360	1300	1700
3.6	3.528	3.672	3.564	3.636	260	360	1300	1700
3.7	3.626	3.774	3.663	3.737	260	360	1300	1700
3.8	3.724	3.876	3.762	3.838	260	360	1300	1700
3.9	3.822	3.978	3.861	3.939	260	360	1300	1700
4.0	3.920	4.080	3.960	4.040	220	320	1100	1500
4.1	4.018	4.182	4.059	4.141	220	320	1100	1500
4.2	4.116	4.284	4.158	4.242	220	320	1100	1500
4.3	4.214	4.386	4.257	4.343	220	320	1100	1500
4.4	4.312	4.488	4.356	4.444	220	320	1100	1500
4.5	4.410	4.590	4.455	4.545	220	320	1100	1500
4.6	4.508	4.692	4.554	4.646	220	320	1100	1500
4.7	4.606	4.794	4.653	4.747	220	320	1100	1500
4.8	4.704	4.896	4.752	4.848	220	320	1100	1500
4.9	4.802	4.998	4.851	4.949	220	320	1100	1500
5.0	4.900	5.100	4.950	5.050	190	280	1000	1300
5.1	4.998	5.202	5.049	5.151	190	280	1000	1300
5.2	5.096	5.304	5.148	5.252	190	280	1000	1300
5.3	5.194	5.406	5.247	5.353	190	280	1000	1300
5.4	5.292	5.508	5.346	5.454	190	280	1000	1300
5.5	5.390	5.610	5.445	5.555	190	280	1000	1300
5.6	5.488	5.712	5.544	5.656	190	280	1000	1300
5.7	5.586	5.814	5.643	5.757	190	280	1000	1300
5.8	5.684	5.916	5.742	5.916	190	280	1000	1300
5.9	5.782	6.018	5.841	5.959	190	280	1000	1300
6.0	5.880	6.120	5.940	6.060	190	280	1000	1300
6.1	5.978	6.222	6.039	6.161	190	280	1000	1300
6.2	6.076	6.324	6.138	6.262	190	280	1000	1300
6.3	6.174	6.426	6.237	6.363	190	280	1000	1300
6.4	6.272	6.528	6.336	6.464	190	280	1000	1300
6.5	6.370	6.630	6.435	6.565	170	230	800	1150
6.6	6.468	6.732	6.534	6.666	170	230	800	1150
6.7	6.566	6.834	6.633	6.767	170	230	800	1150
6.8	6.664	6.936	6.732	6.868	170	230	800	1150
6.9	6.762	7.038	6.831	6.969	170	230	800	1150
7.0	6.860	7.140	6.930	7.070	170	230	800	1150

ELECTRICAL OPERATING CHARACTERISTICS (CONTINUED)

Voltage Chart (Continued)

SYMBOL OUTPUT VOLTAGE $V_{OUT(T)}$ (V)	E-0				E-1		E-2	
	OUTPUT VOLTAGE, V				DROPOUT VOLTAGE, mV		DROPOUT VOLTAGE, mV	
	$V_{OUT(E)}$				$I_{OUT} = 20\text{ mA}$		$I_{OUT} = 100\text{ mA}$	
	2% accuracy		1% accuracy		Vdif1		Vdif2	
	MIN.	MAX.	MIN.	MAX.	TYP.	MAX.	TYP.	MAX.
7.1	6.958	7.242	7.029	7.171	170	230	800	1150
7.2	7.056	7.344	7.128	7.272	170	230	800	1150
7.3	7.154	7.446	7.227	7.373	170	230	800	1150
7.4	7.252	7.548	7.326	7.474	170	230	800	1150
7.5	7.350	7.650	7.425	7.575	170	230	800	1150
7.6	7.448	7.752	7.524	7.676	170	230	800	1150
7.7	7.546	7.854	7.623	7.777	170	230	800	1150
7.8	7.644	7.956	7.722	7.878	170	230	800	1150
7.9	7.742	8.058	7.821	7.979	170	230	800	1150
8.0	7.840	8.160	7.920	8.080	170	230	800	1150
8.1	7.938	8.262	8.019	8.181	130	190	700	950
8.2	8.036	8.364	8.118	8.282	130	190	700	950
8.3	8.134	8.466	8.217	8.383	130	190	700	950
8.4	8.232	8.568	8.316	8.484	130	190	700	950
8.5	8.330	8.670	8.415	8.585	130	190	700	950
8.6	8.428	8.772	8.514	8.686	130	190	700	950
8.7	8.526	8.874	8.613	8.787	130	190	700	950
8.8	8.624	8.976	8.712	8.888	130	190	700	950
8.9	8.722	9.078	8.811	8.989	130	190	700	950
9.0	8.820	9.180	8.910	9.090	130	190	700	950
9.1	8.918	9.282	9.009	9.191	130	190	700	950
9.2	9.016	9.384	9.108	9.292	130	190	700	950
9.3	9.114	9.486	9.207	9.393	130	190	700	950
9.4	9.212	9.588	9.306	9.494	130	190	700	950
9.5	9.310	9.690	9.405	9.595	130	190	700	950
9.6	9.408	9.792	9.504	9.696	130	190	700	950
9.7	9.506	9.894	9.603	9.797	130	190	700	950
9.8	9.604	9.996	9.702	9.898	130	190	700	950
9.9	9.702	10.098	9.801	9.999	130	190	700	950
10.0	9.800	10.200	9.900	10.100	130	190	700	950
10.1	9.898	10.302	9.999	10.201	120	160	650	850
10.2	9.996	10.404	10.098	10.302	120	160	650	850
10.3	10.094	10.506	10.197	10.403	120	160	650	850
10.4	10.192	10.608	10.296	10.504	120	160	650	850
10.5	10.290	10.710	10.395	10.605	120	160	650	850
10.6	10.388	10.812	10.494	10.706	120	160	650	850
10.7	10.486	10.914	10.593	10.807	120	160	650	850
10.8	10.584	11.016	10.692	10.908	120	160	650	850
10.9	10.682	11.118	10.791	11.009	120	160	650	850
11.0	10.780	11.220	10.890	11.110	120	160	650	850
11.1	10.878	11.322	10.989	11.211	120	160	650	850
11.2	10.976	11.424	11.088	11.312	120	160	650	850
11.3	11.074	11.526	11.187	11.413	120	160	650	850
11.4	11.172	11.628	11.286	11.514	120	160	650	850
11.5	11.270	11.730	11.385	11.615	120	160	650	850
11.6	11.368	11.832	11.484	11.716	120	160	650	850
11.7	11.466	11.934	11.583	11.817	120	160	650	850
11.8	11.564	12.036	11.682	11.918	120	160	650	850
11.9	11.662	12.138	11.781	12.019	120	160	650	850
12.0	11.760	12.240	11.880	12.120	120	160	650	850

PIN CONFIGURATION

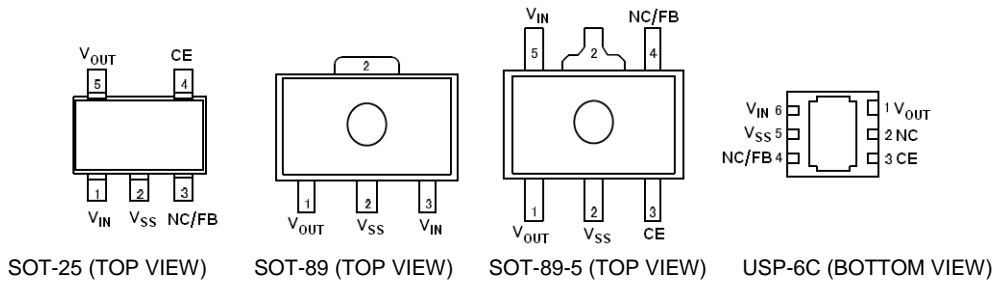

The dissipation pad for the USP-6C package should be solder-plated in respect with mounting pattern and metal mask to improve heat dissipation and mounting strength. If the pad needs to be connected to other pins, it should be connected to the V_{SS} (No. 5) pin.

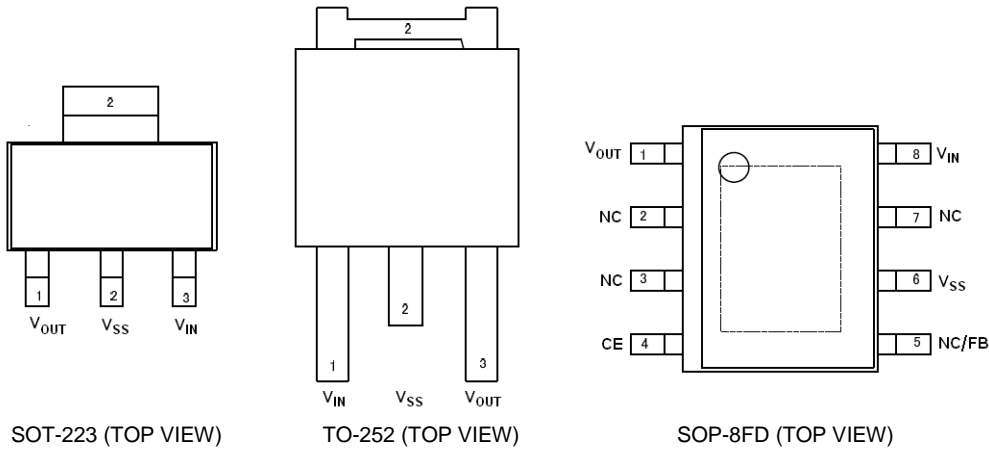

PIN ASSIGNMENT

PIN NUMBER							PIN NAME	FUNCTIONS
SOT-25	SOT-89	SOT-89-5	USP-6C	SOT-223	TO-252	SOP-8FD		
1	3	5	6	3	1	8	V_{IN}	Power Input
	2	2	5	2	2	6	V_{SS}	Ground
5	1	1	1	1	3	1	V_{OUT}	Output Voltage
4		3	3			4	CE	ON/OFF Control LOW – Standby mode, HIGH – Active ¹⁾
			2			2, 3, 7	NC	No Connection
3		4	4			5		No Connection (B series)/FB (C series)

1) CE pin does not have internal pull-down resistor. IC state is undefined, if this pin is open.

BLOCK DIAGRAMS

IXD1216B

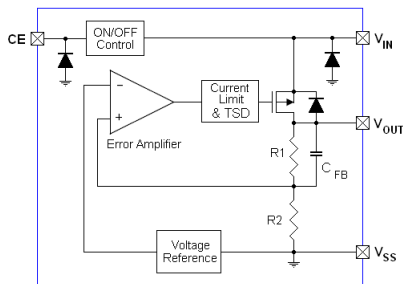

IXD1216C

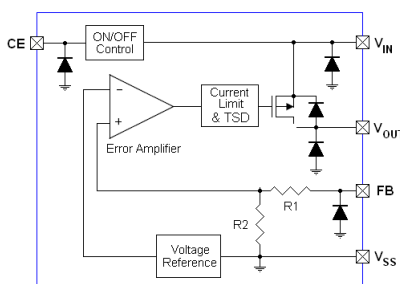

IXD1216D

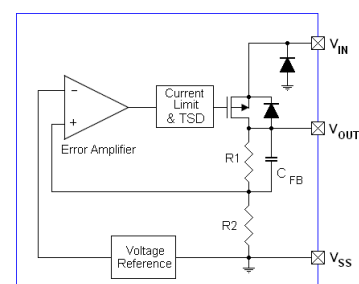

Diodes inside the circuits are ESD protection diodes and parasitic diodes.

BASIC OPERATION

The Error Amplifier of the IXD1216 series monitors output voltage divided by internal resistors R1 & R2 and compares it with the internal Reference Voltage (see Block Diagram above). The output signal from error amplifier drives gate of the P-channel MOSFET, which is connected to the V_{OUT} pin and operates as a series voltage regulator.

The Current Limit/Short Protection circuits monitor level of the output current, and Thermal shutdown circuit monitors MOSFET junction temperature to prevent IC damage by excessive current.

The CE pin allows shutdown internal circuitry to minimize power consumption.

Current Limiter, Short-Circuit Protection

The IXD1216 series have a current limiter circuit & a fold back circuit, which aid the operations of the current limiter and circuit protection. When the load current reaches the current limit level, the fixed current limiter circuit activates and output voltage drops. Because of this drop, the fold back circuit activates too, and output voltage drops further decreasing output current. When the output pin is shorted, a current of about 30 mA flows.

Thermal Shutdown

When the junction temperature of the built-in transistor reaches the temperature limit, the thermal shutdown circuit activates and turns transistor OFF. The IC resumes normal operation when the junction temperature falls below value determined by Thermal Shutdown Hysteresis.

CE Pin

The CE pin allows shutdown internal circuitry to minimize power consumption. In shutdown mode, output at the V_{OUT} pin is pulled down to the V_{SS} level by resistors R1 and R2 connected in series.

Note that the CE input is active HIGH and has no pull down resistor. IC will be in undefined state, if CE pin is open. CE pin should be connected to either V_{IN} or ground. IC current consumption may increase, if voltage applied to this pin is ~ 0.5 of V_{IN}.

Minimum Operating Voltage

The input voltage should be above 2.0 V for the stable IC operation.

TYPICAL APPLICATION CIRCUIT

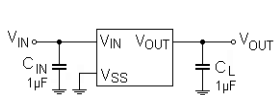

IXD1216B version

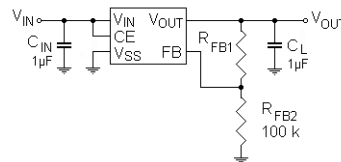

IXD1216C version

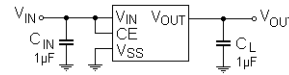

IXD1216D version

LAYOUT AND USE CONSIDERATIONS

1. Mount external component as close to the IC as possible and use thick, short connecting traces to reduce the circuit impedance.
2. The IC may malfunction if absolute maximum ratings are exceeded.
3. If power source of this regulator is a high impedance device, an input capacitor C_{IN} ≥ 0.1µF should be used to prevent oscillations.
4. The internal phase compensation guarantees the IXD1216 stable operations even without load capacitor C_L. However, load capacitor C_L = 0.1 – 1.0 µF located as close to V_{OUT} and V_{SS} pins may improve regulator's dynamic characteristics, reducing over/undershoot at heavy load.
5. In case of high output current, increasing the input capacitor value can stabilize operations.
6. Please ensure that output current I_{OUT} is less than P_D / (V_{IN} - V_{OUT}), where P_D is a rated power dissipation value of the package shown at ABSOLUTE MAXIMUM RATING table to not exceed it.
7. The IXD1216C version requires external resistive divider to set output voltage above 2.0 V. Output voltage determined by resistors R₂₁/R₂₂ as well as resistance of the internal resistive divider R_{FB}, which is in the range from 1.7 MΩ to 6.3 MΩ.

$$V_{OUT} = 2.0V \times \left(\frac{R_{21} + R_{22}}{R_{22}} + \frac{R_{21}}{R_{FB}} \right)$$

Component R_{21}/R_{FB} determines error in voltage setting and it should be taken into considerations, if R_{21} value is close to value of R_{FB} . If R_{21} is less than 10 k Ω , this error is negligible.

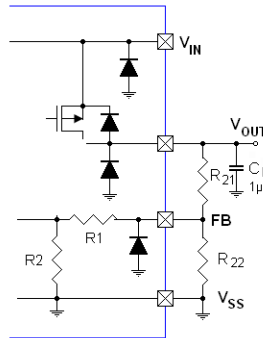

Example:

If $R_{21} = 64.9 \text{ k}\Omega$ and $R_{22} = 100 \text{ k}\Omega$, output voltage may vary from part to part due difference in R_{FB} from 3.318 V to 3.374 V.

If $R_{21} = 6.49 \text{ }\Omega$ and $R_{22} = 10 \text{ k}\Omega$, output voltage will vary from part to part due difference in R_{FB} from 3.300 V to 3.306 V.

TEST CIRCUITS

Circuit ①

IXD1216B

IXD1216C

IXD1216D

Circuit ②

IXD1216B

IXD1216C

IXD1216D

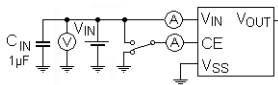
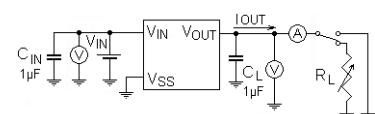
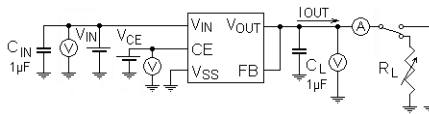
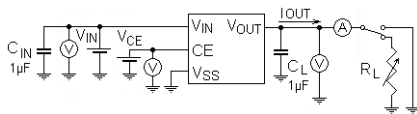

Circuit ③

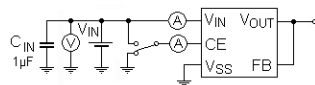

IXD1216B

IXD1216C

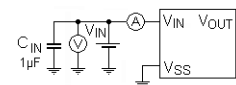

IXD1216D

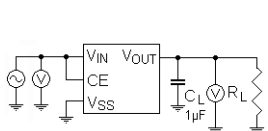

Circuit ④

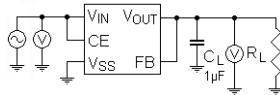

IXD1216C

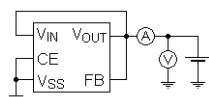

Unless otherwise stated, $T_a = 25^\circ\text{C}$, $V_{CE} = V_{IN}$, $C_{IN} = C_L = 1 \text{ }\mu\text{F}$ (ceramic)
The IXD1216D has CE pin connected to V_{IN} internally.

TYPICAL PERFORMANCE CHARACTERISTICS

(1) Output Voltage vs. Output Current

IXD1216x202xx
 $V_{IN} = V_{CE} = 5.0\text{ V}$

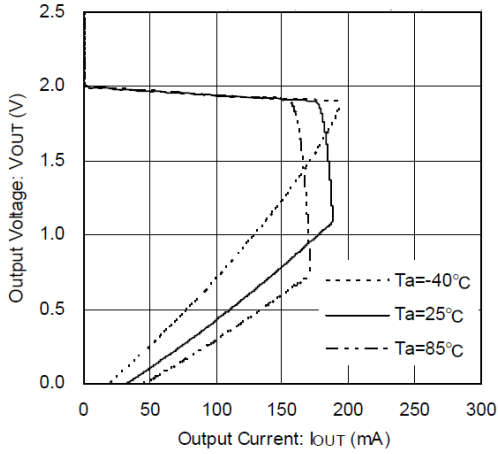

IXD1216x202xx
 $V_{IN} = V_{CE}, T_a = 25^\circ\text{C}$

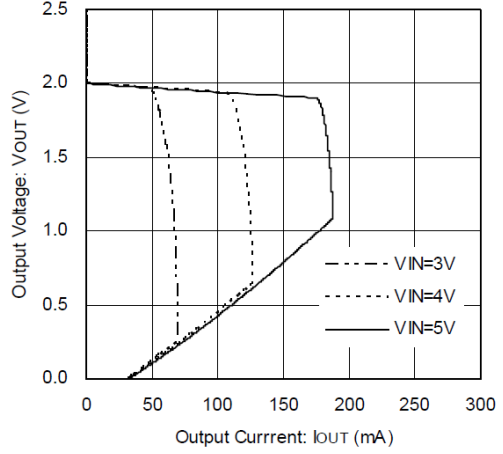

IXD1216B/D 332xx
 $V_{IN} = V_{CE} = 6.3\text{ V}$

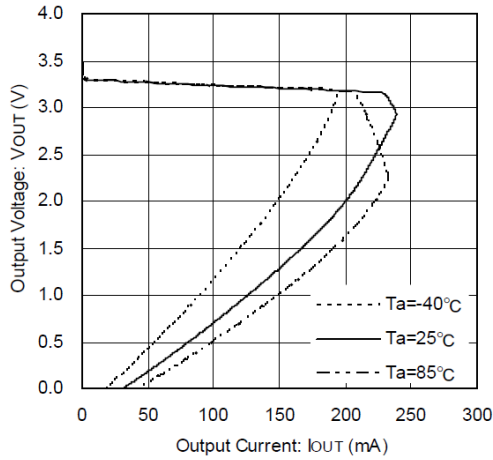

IXD1216B/D 332xx
 $V_{IN} = V_{CE}, T_a = 25^\circ\text{C}$

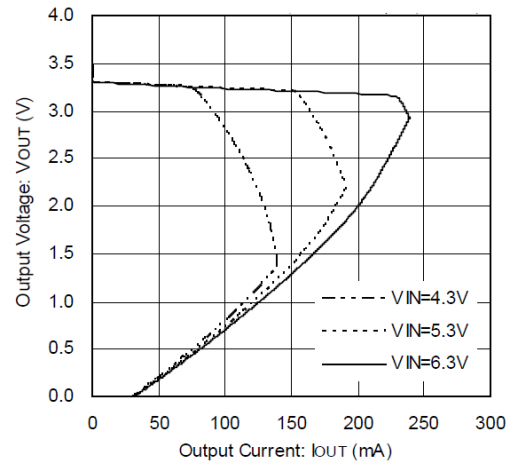

IXD1216B/D 502xx
 $V_{IN} = V_{CE} = 8.0\text{ V}$

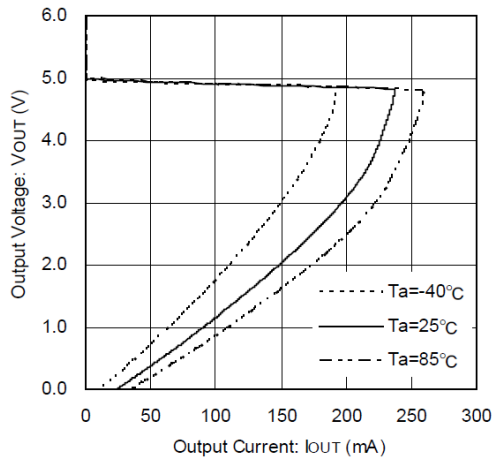

IXD1216B/D 502xx
 $V_{IN} = V_{CE}, T_a = 25^\circ\text{C}$

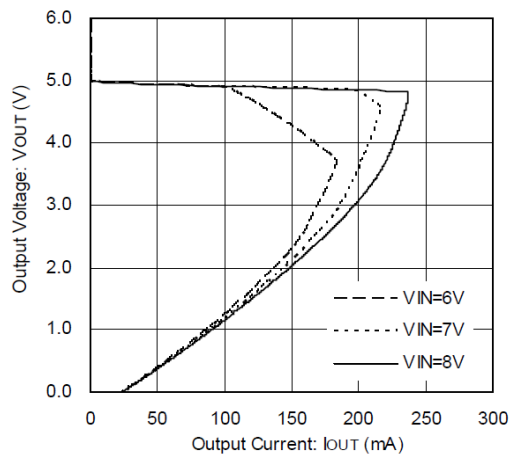

TYPICAL PERFORMANCE CHARACTERISTICS (Continued)

(1) Output Voltage vs Output Current (Continue)

Topr = 25 °C

IXD1216B/D C02xx

$V_{IN} = V_{CE} = 15.0\text{ V}$

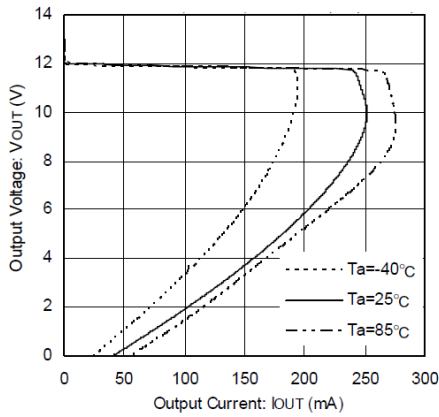

IXD1216B/D C02xx

$V_{IN} = V_{CE}, Ta = 25^\circ\text{C}$

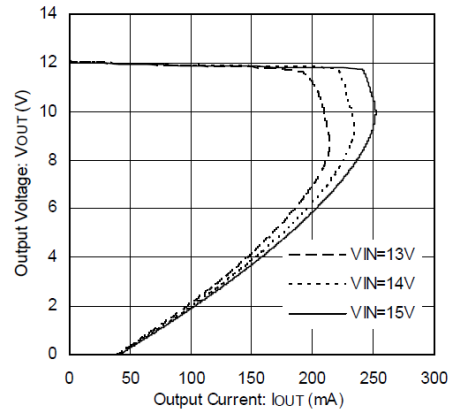

(2) Output Voltage vs. Input Voltage

IXD1216x202xx

$V_{IN} = V_{CE}, Ta = 25^\circ\text{C}$

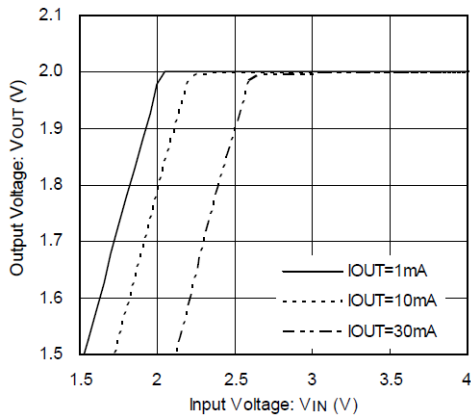

IXD1216x202xx

$V_{IN} = V_{CE}, Ta = 25^\circ\text{C}$

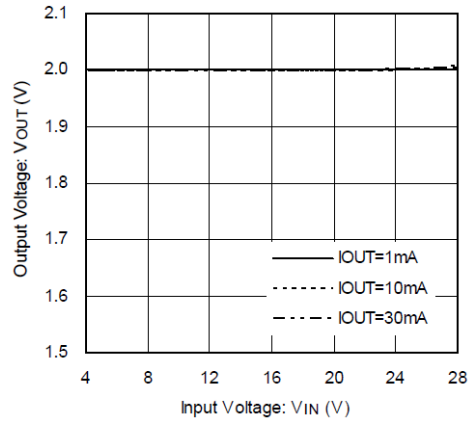

IXD1216B/D 332xx

$V_{IN} = V_{CE}, Ta = 25^\circ\text{C}$

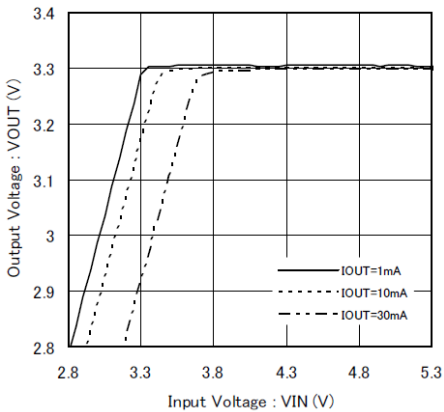

IXD1216B/D 332xx

$V_{IN} = V_{CE}, Ta = 25^\circ\text{C}$

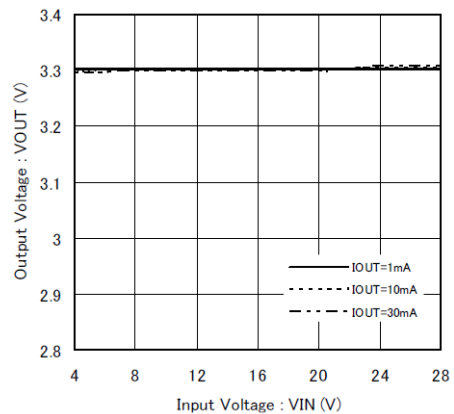

TYPICAL PERFORMANCE CHARACTERISTICS (Continued)

(2) Output Voltage vs. Input Voltage

IXD1216B/D 502xx
 $V_{IN} = V_{CE}$, $T_a = 25^\circ\text{C}$

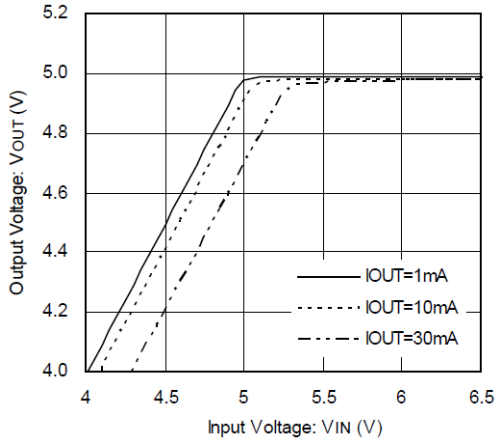

IXD1216B/D 502xx
 $V_{IN} = V_{CE}$, $T_a = 25^\circ\text{C}$

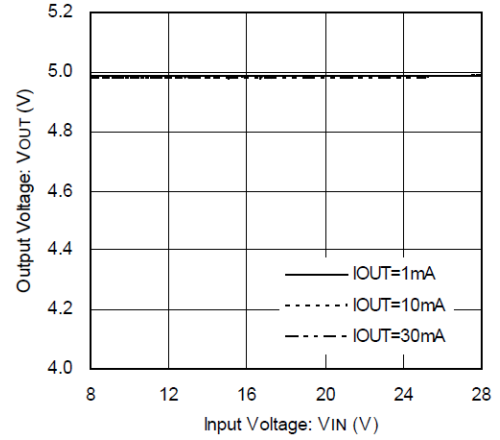

IXD1216B/D C02xx
 $V_{IN} = V_{CE}$, $T_a = 25^\circ\text{C}$

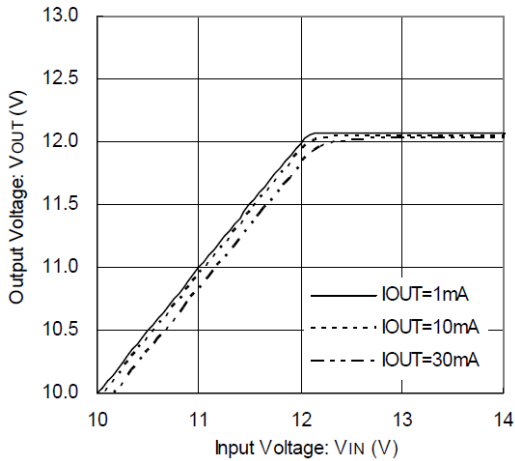

IXD1216B/D C02xx
 $V_{IN} = V_{CE}$, $T_a = 25^\circ\text{C}$

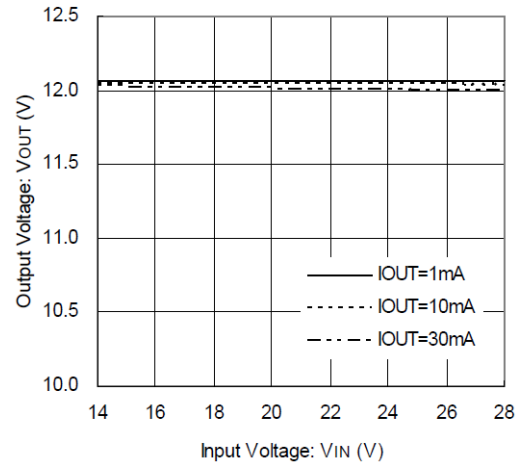

(3) Dropout Voltage vs. Output Current

IXD1216x202xx

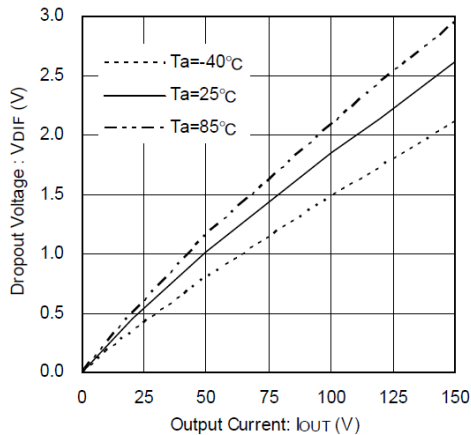

IXD1216B/D 332xx

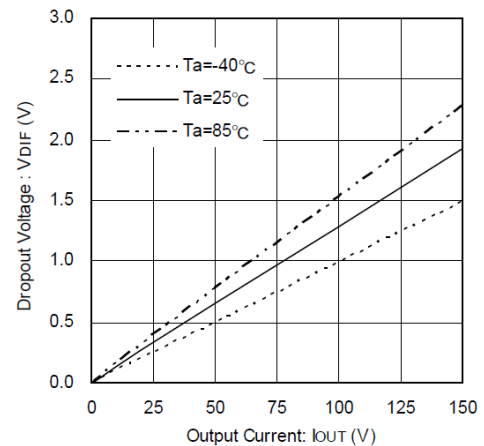

TYPICAL PERFORMANCE CHARACTERISTICS (Continued)

(3) Dropout Voltage vs. Output Current (Continued)

IXD1216B/D 502xx

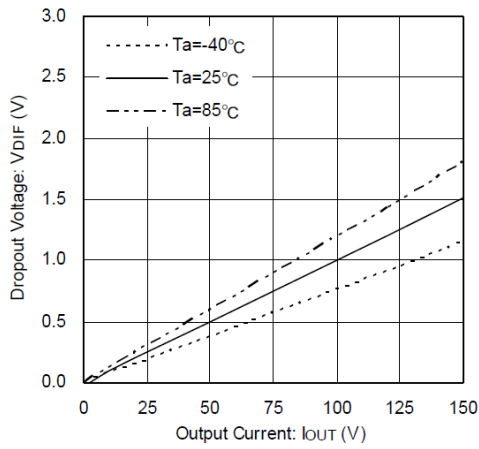

IXD1216B/D C02xx

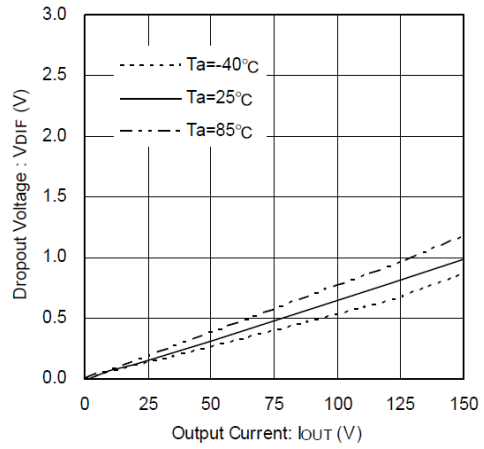

(4) Supply Current vs. Input Voltage

IXD1216x202xx

$V_{IN} = V_{CE}$

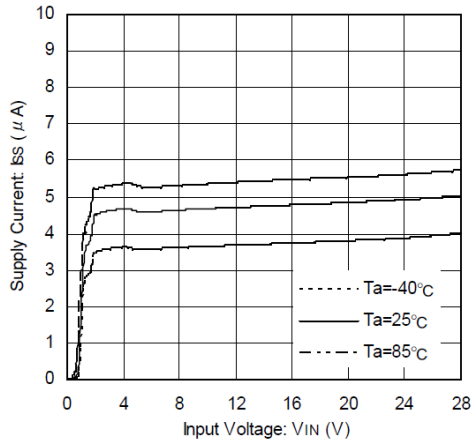

IXD1216x202xx

$V_{IN} = V_{CE} = 4.0\text{ V}$

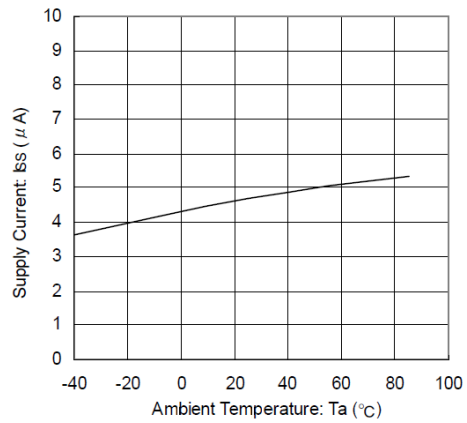

IXD1216B/D 332xx

$V_{IN} = V_{CE}$

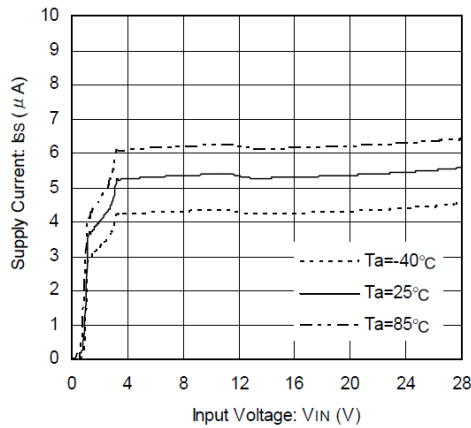

IXD1216B/D 332xx

$V_{IN} = V_{CE} = 5.3\text{ V}$

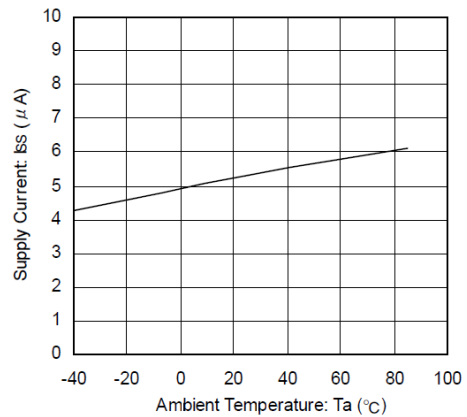

TYPICAL PERFORMANCE CHARACTERISTICS (Continued)

(4) Supply Current vs. Input Voltage (Continued)

IXD1216B/D 502xx

$V_{IN} = V_{CE}$

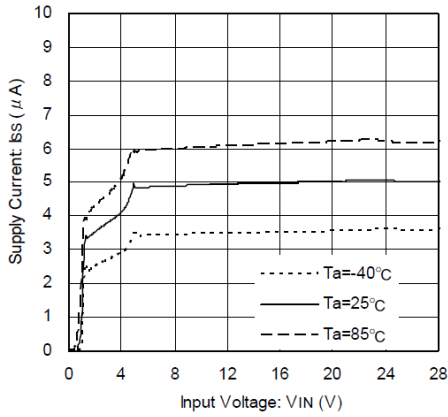

IXD1216B/D 502xx

$V_{IN} = V_{CE} = 7.0 V$

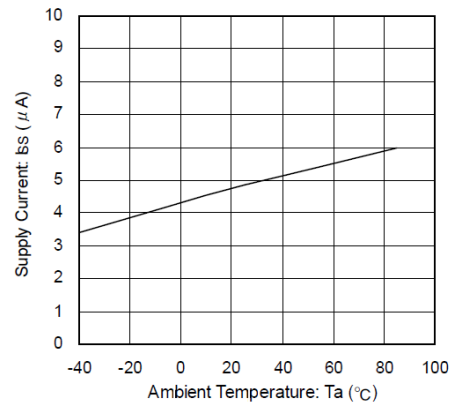

IXD1216B/D C02xx

$V_{IN} = V_{CE}$

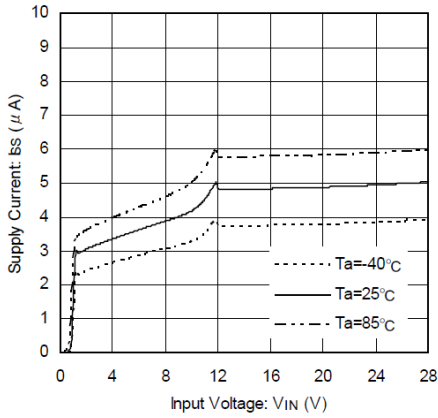

IXD1216B/D C02xx

$V_{IN} = V_{CE} = 14.0 V$

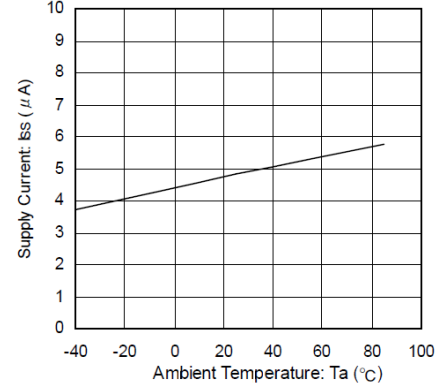

(5) Output Voltage vs. Ambient Temperature

IXD1216x202xx

$V_{IN} = V_{CE} = 4.0 V$

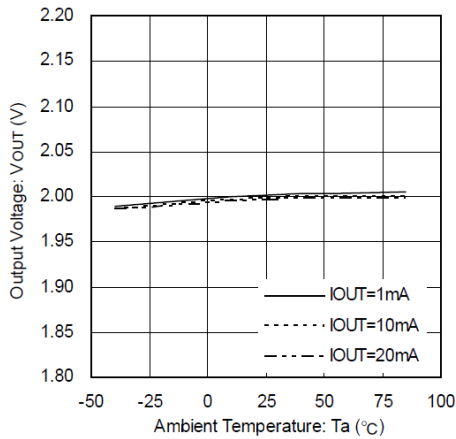

IXD1216B/D 332xx

$V_{IN} = V_{CE} = 5.3 V$

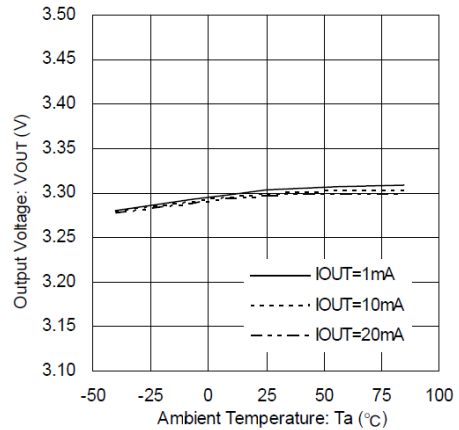

TYPICAL PERFORMANCE CHARACTERISTICS (Continued)

(5) Output Voltage vs. Ambient temperature (Continued)

IXD1216B/D 502xx
 $V_{IN} = V_{CE} = 7.0\text{ V}$

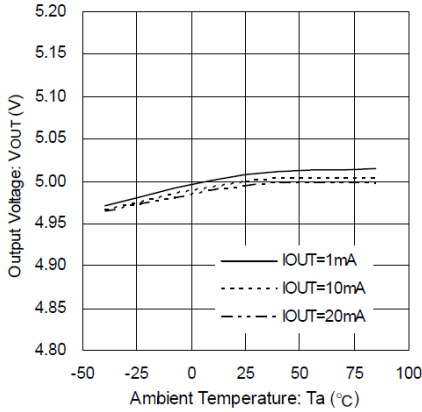

IXD1216B/D C02xx
 $V_{IN} = V_{CE} = 14.0\text{ V}$

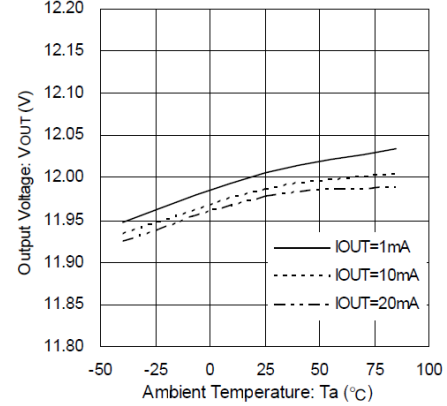

(6) Input Voltage Transient Response

IXD1216x202xx

$I_{OUT} = 1\text{ mA}$, $T_a = 25^\circ\text{C}$, $t_r = t_f = 5\ \mu\text{s}$, $V_{IN} = 4.0\text{ V} \leftrightarrow 5.0\text{ V}$

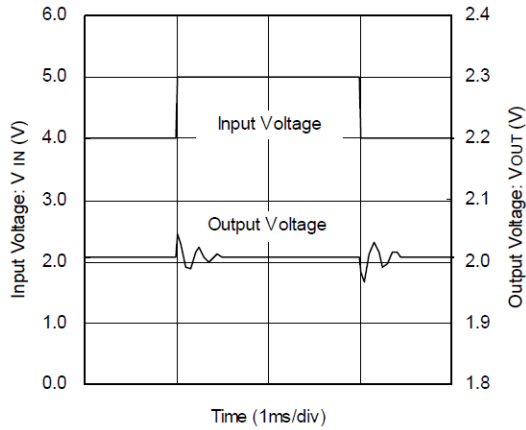

IXD1216x202xx

$I_{OUT} = 30\text{ mA}$, $T_a = 25^\circ\text{C}$, $t_r = t_f = 5\ \mu\text{s}$, $V_{IN} = 4.0\text{ V} \leftrightarrow 5.0\text{ V}$

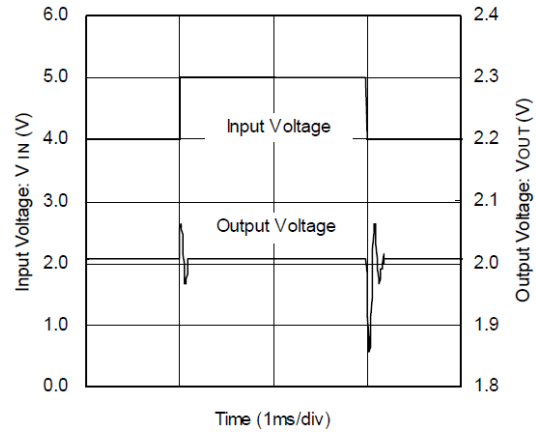

IXD1216B/D 332xx

$I_{OUT} = 1\text{ mA}$, $T_a = 25^\circ\text{C}$, $t_r = t_f = 5\ \mu\text{s}$, $V_{IN} = 5.3\text{ V} \leftrightarrow 6.3\text{ V}$

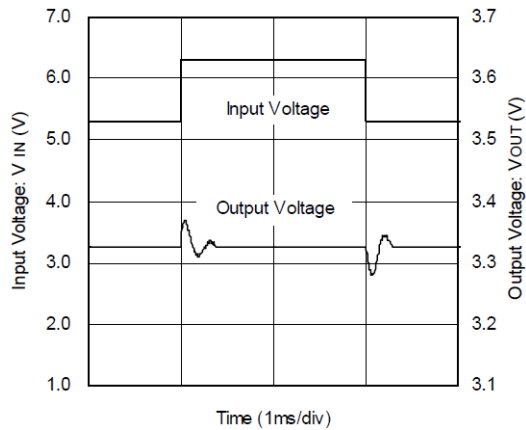

IXD1216B/D 332xx

$I_{OUT} = 30\text{ mA}$, $T_a = 25^\circ\text{C}$, $t_r = t_f = 5\ \mu\text{s}$, $V_{IN} = 5.3\text{ V} \leftrightarrow 6.3\text{ V}$

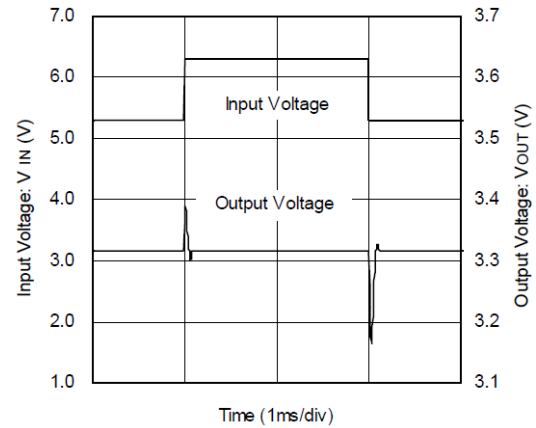

TYPICAL PERFORMANCE CHARACTERISTICS (Continued)

(6) Input Voltage Transient Response (Continued)

IXD1216B/D 502xx

$I_{OUT} = 1\text{ mA}$, $T_a = 25^\circ\text{C}$, $t_r = t_f = 5\ \mu\text{s}$, $V_{IN} = 7.0\ \text{V} \leftrightarrow 8.0\ \text{V}$

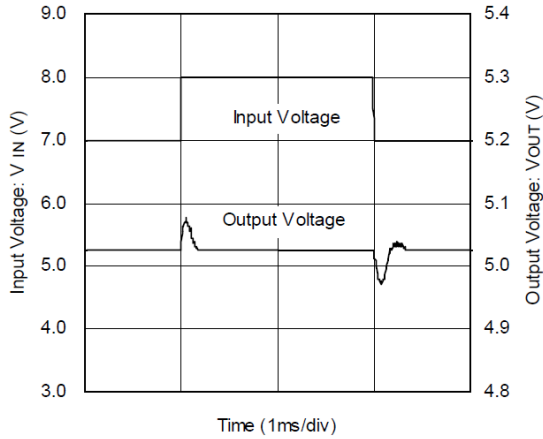

IXD1216B/D 502xx

$I_{OUT} = 30\ \text{mA}$, $T_a = 25^\circ\text{C}$, $t_r = t_f = 5\ \mu\text{s}$, $V_{IN} = 7.0\ \text{V} \leftrightarrow 8.0\ \text{V}$

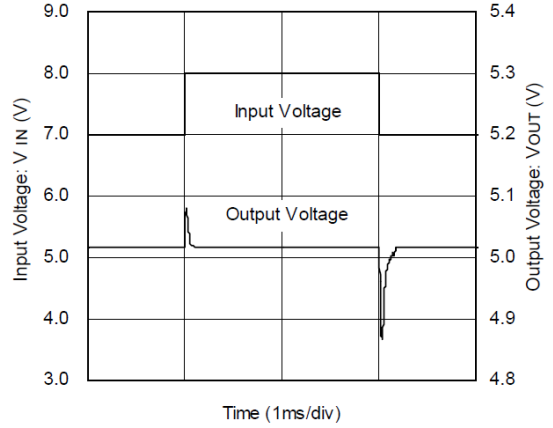

IXD1216B/D C02xx

$I_{OUT} = 1\ \text{mA}$, $T_a = 25^\circ\text{C}$, $t_r = t_f = 5\ \mu\text{s}$, $V_{IN} = 14.0\ \text{V} \leftrightarrow 15.0\ \text{V}$

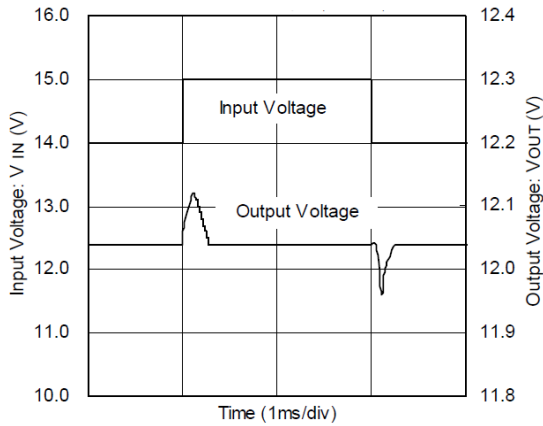

IXD1216B/D C02xx

$I_{OUT} = 30\ \text{mA}$, $T_a = 25^\circ\text{C}$, $t_r = t_f = 5\ \mu\text{s}$, $V_{IN} = 14.0\ \text{V} \leftrightarrow 15.0\ \text{V}$

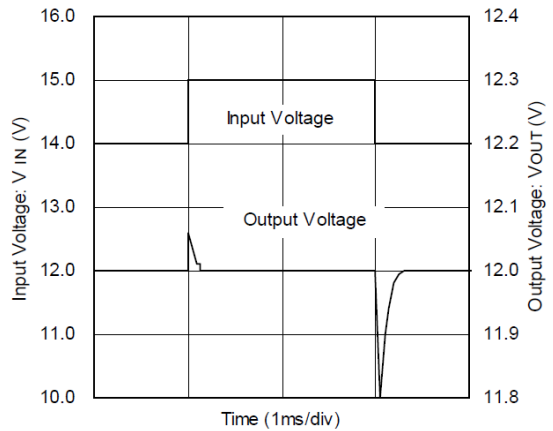

(7) Load Transient Response

IXD1216x202xx

$T_a = 25^\circ\text{C}$, $t_r = t_f = 5\ \mu\text{s}$, $V_{IN} = 4.0\ \text{V}$, $I_{OUT} = 1\ \text{mA} \leftrightarrow 30\ \text{mA}$

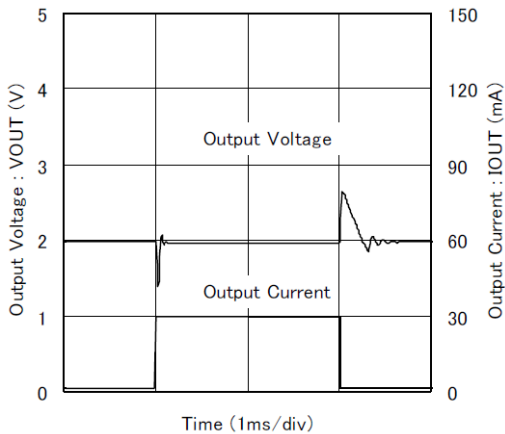

IXD1216B/D 332xx

$T_a = 25^\circ\text{C}$, $t_r = t_f = 5\ \mu\text{s}$, $V_{IN} = 4.0\ \text{V}$, $I_{OUT} = 1\ \text{mA} \leftrightarrow 30\ \text{mA}$

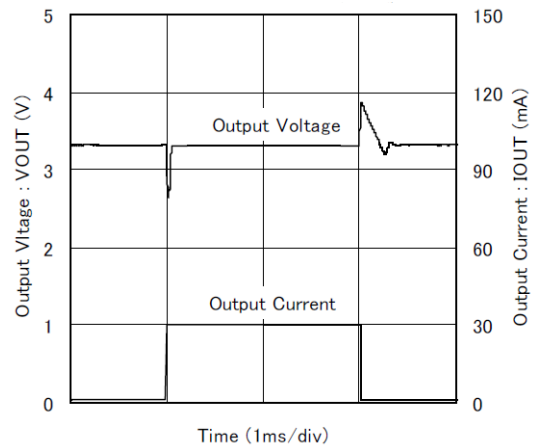

TYPICAL PERFORMANCE CHARACTERISTICS (Continued)

(7) Load Transient Response (Continued)

IXD1216B/D 502xx

Ta = 25°C, tr = tf = 5 μs, VIN = 7.0 V IOUT = 1 mA, ↔ 30 mA

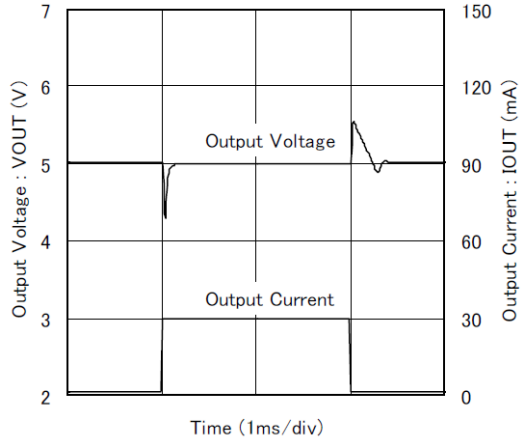

IXD1216B/D C02xx

Ta = 25°C, tr = tf = 5 μs, VIN = 14.0 V IOUT = 1 mA, ↔ 30 mA

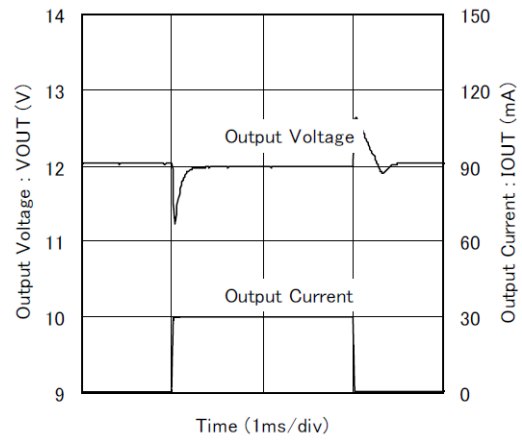

(8) Input Voltage Rising Response Time

IXD1216x202xx

Ta = 25°C, tr = 5 μs, VIN = 0 → 4.0 V IOUT = 1 mA,

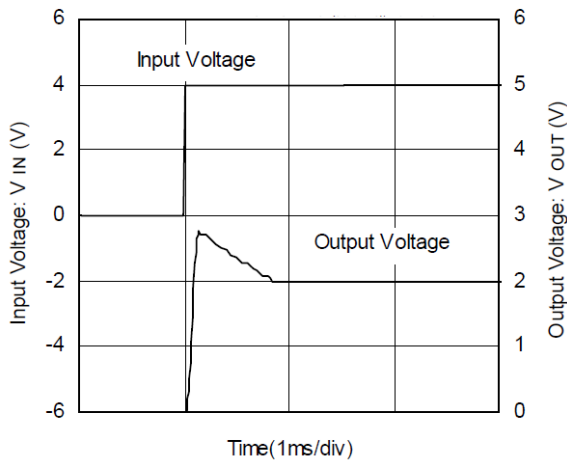

IXD1216x202xx

Ta = 25°C, tr = 5 μs, VIN = 0 → 4.0 V IOUT = 30 mA,

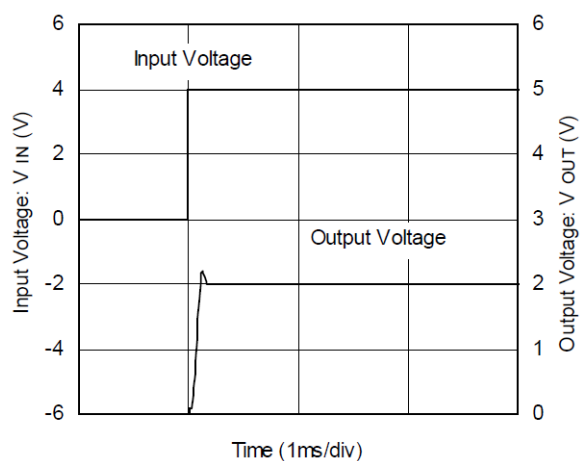

IXD1216B/D 332xx

Ta = 25°C, tr = 5 μs, VIN = 0 → 5.3 V IOUT = 1 mA,

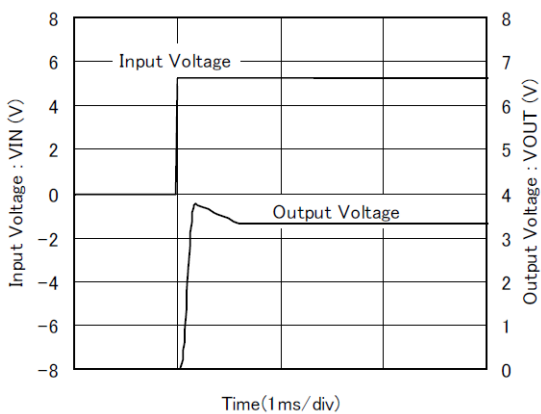

IXD1216B/D 332xx

Ta = 25°C, tr = 5 μs, VIN = 0 → 5.3 V IOUT = 30 mA,

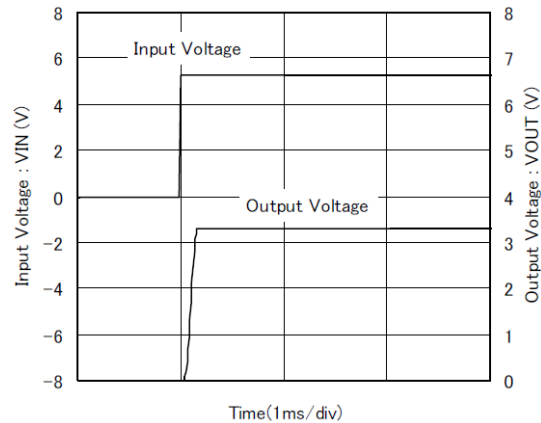

TYPICAL PERFORMANCE CHARACTERISTICS (Continued)

(8) Input Voltage Rising Response Time (Continued)

IXD1216B/D 502xx

$T_a = 25^\circ\text{C}$, $t_{\text{r}} = 5 \mu\text{s}$, $V_{\text{IN}} = 0 \rightarrow 7.0 \text{ V}$ $I_{\text{OUT}} = 1 \text{ mA}$,

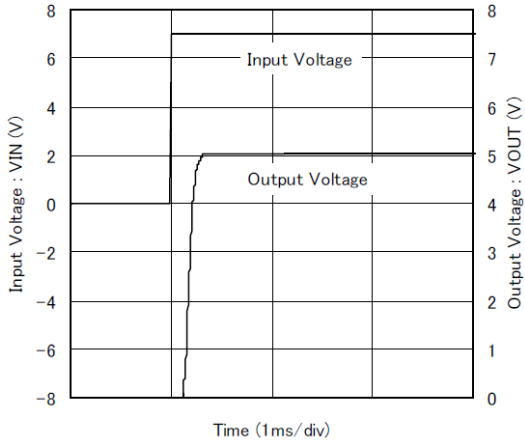

IXD1216B/D 502xx

$T_a = 25^\circ\text{C}$, $t_{\text{r}} = 5 \mu\text{s}$, $V_{\text{IN}} = 0 \rightarrow 7.0 \text{ V}$ $I_{\text{OUT}} = 30 \text{ mA}$

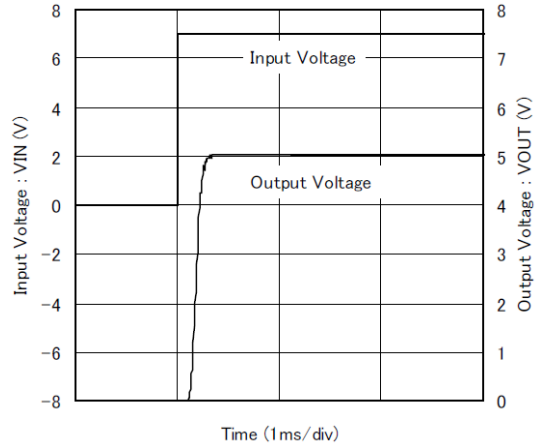

IXD1216B/D C02xx

$T_a = 25^\circ\text{C}$, $t_{\text{r}} = 5 \mu\text{s}$, $V_{\text{IN}} = 0 \rightarrow 14.0 \text{ V}$ $I_{\text{OUT}} = 1 \text{ mA}$,

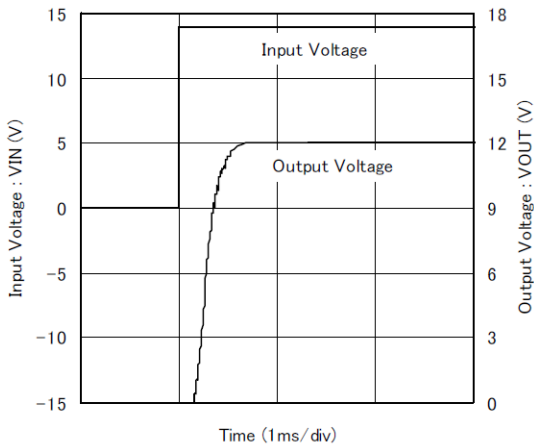

IXD1216B/D C02xx

$T_a = 25^\circ\text{C}$, $t_{\text{r}} = 5 \mu\text{s}$, $V_{\text{IN}} = 0 \rightarrow 14.0 \text{ V}$ $I_{\text{OUT}} = 30 \text{ mA}$

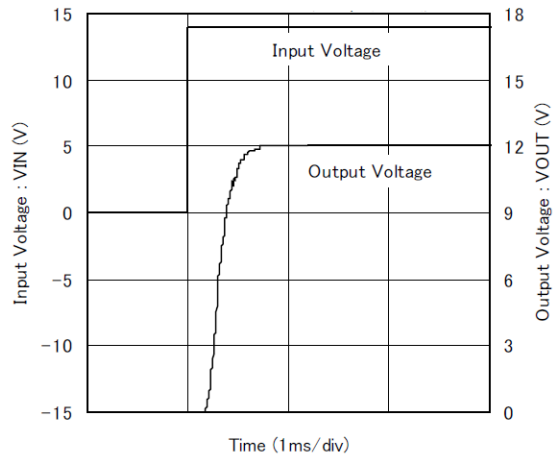

(9) CE Rising Response Time

IXD1216x202xx

$T_a = 25^\circ\text{C}$, $t_{\text{r}} = 5 \mu\text{s}$, $V_{\text{IN}} = 4.0 \text{ V}$, $V_{\text{CE}} = 0 \rightarrow 4.0 \text{ V}$ $I_{\text{OUT}} = 1 \text{ mA}$

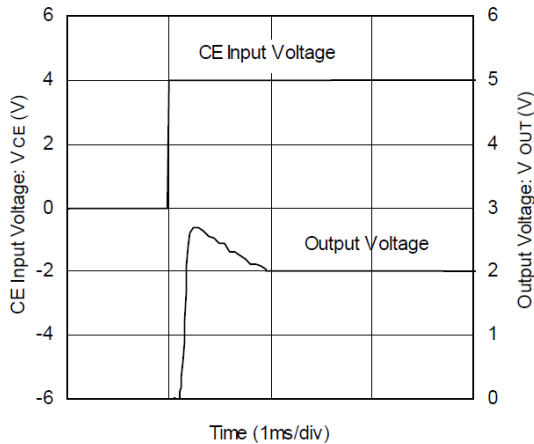

IXD1216x202xx

$T_a = 25^\circ\text{C}$, $t_{\text{r}} = 5 \mu\text{s}$, $V_{\text{IN}} = 4.0 \text{ V}$, $V_{\text{CE}} = 0 \rightarrow 4.0 \text{ V}$ $I_{\text{OUT}} = 30 \text{ mA}$

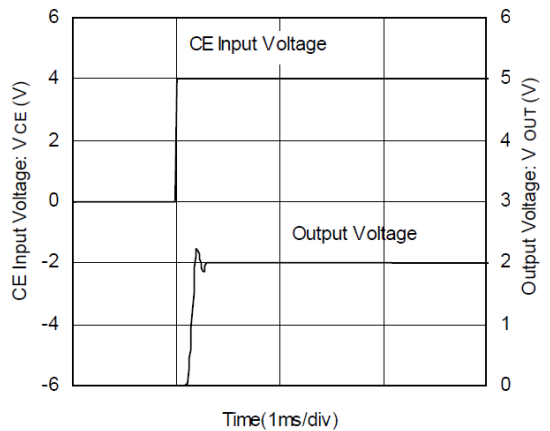

TYPICAL PERFORMANCE CHARACTERISTICS (Continued)

(9) CE Rising Response Time (Continued)

IXD1216B/D 332xx

$T_a = 25^\circ\text{C}$, $t_r = 5 \mu\text{s}$, $V_{IN} = 5.3 \text{ V}$, $V_{CE} = 0 \rightarrow V_{IN}$, $I_{OUT} = 1 \text{ mA}$,

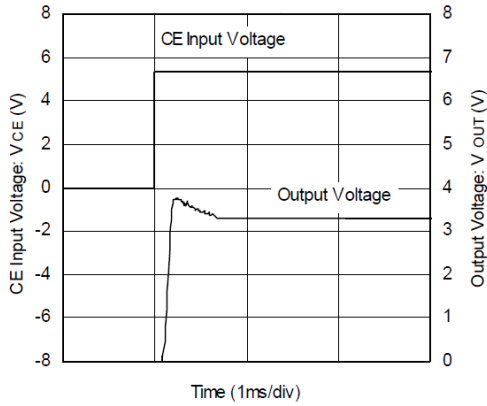

IXD1216B/D 332xx

$T_a = 25^\circ\text{C}$, $t_r = 5 \mu\text{s}$, $V_{IN} = 5.3 \text{ V}$, $V_{CE} = 0 \rightarrow V_{IN}$, $I_{OUT} = 30 \text{ mA}$

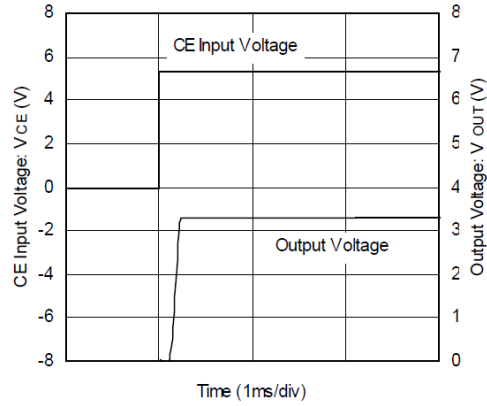

IXD1216B/D 502xx

$T_a = 25^\circ\text{C}$, $t_r = 5 \mu\text{s}$, $V_{IN} = 7.0 \text{ V}$, $V_{CE} = 0 \rightarrow V_{IN}$, $I_{OUT} = 1 \text{ mA}$,

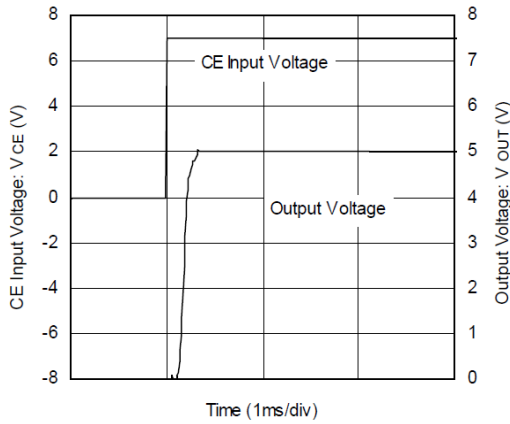

IXD1216B/D 502xx

$T_a = 25^\circ\text{C}$, $t_r = 5 \mu\text{s}$, $V_{IN} = 7.0 \text{ V}$, $V_{CE} = 0 \rightarrow V_{IN}$, $I_{OUT} = 30 \text{ mA}$

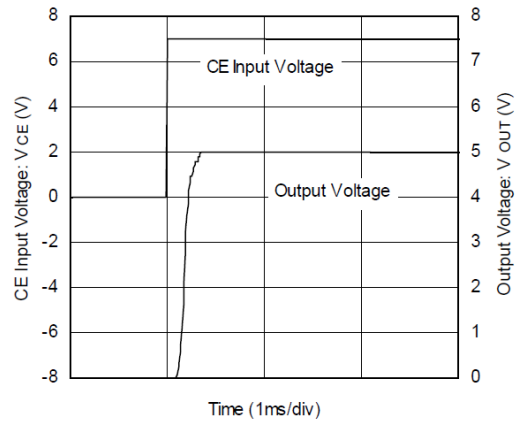

IXD1216B/D C02xx

$T_a = 25^\circ\text{C}$, $t_r = 5 \mu\text{s}$, $V_{IN} = 14.0 \text{ V}$, $V_{CE} = 0 \rightarrow V_{IN}$, $I_{OUT} = 1 \text{ mA}$,

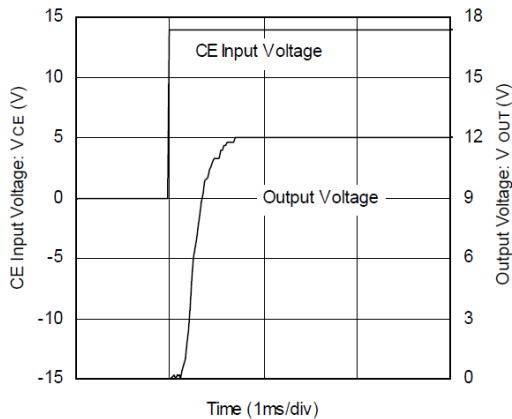

IXD1216B/D C02xx

$T_a = 25^\circ\text{C}$, $t_r = 5 \mu\text{s}$, $V_{IN} = 14.0 \text{ V}$, $V_{CE} = 0 \rightarrow V_{IN}$, $I_{OUT} = 30 \text{ mA}$

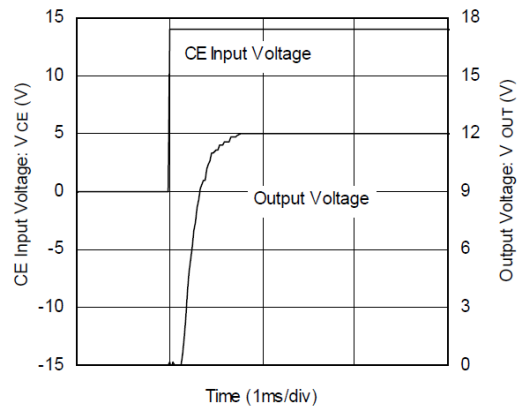

TYPICAL PERFORMANCE CHARACTERISTICS (Continued)

(10) Power Supply Ripple Rejection

IXD1216x202xx

$T_a = 25^\circ\text{C}$, $V_{IN} = V_{CE} = 4.0\text{ V} + 0.5\text{ Vp-pAC}$, $I_{OUT} = 1\text{ mA}$,

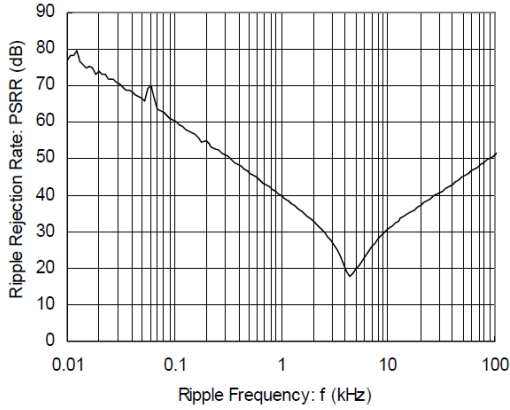

IXD1216x202xx

$T_a = 25^\circ\text{C}$, $V_{IN} = V_{CE} = 4.0\text{ V} + 0.5\text{ Vp-pAC}$, $I_{OUT} = 30\text{ mA}$,

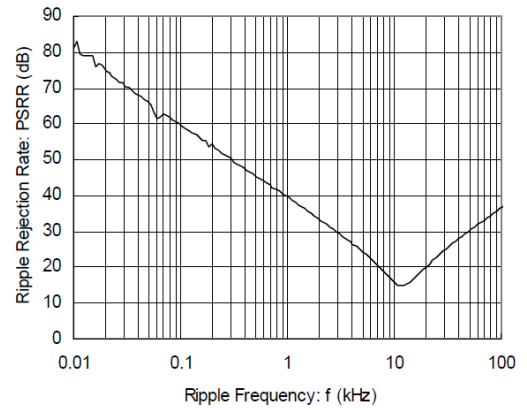

IXD1216B/D 332xx

$T_a = 25^\circ\text{C}$, $V_{IN} = V_{CE} = 5.3\text{ V} + 0.5\text{ Vp-pAC}$, $I_{OUT} = 1\text{ mA}$,

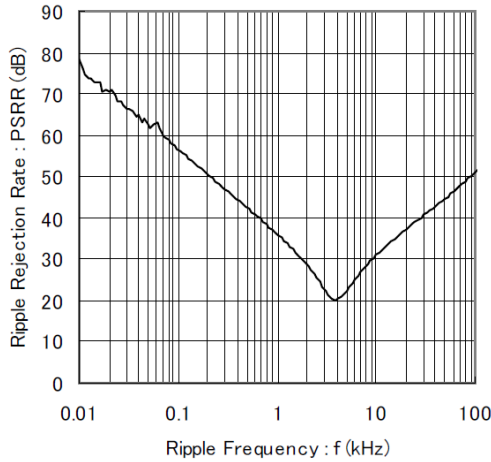

IXD1216B/D 332xx

$T_a = 25^\circ\text{C}$, $V_{IN} = V_{CE} = 5.3\text{ V} + 0.5\text{ Vp-pAC}$, $I_{OUT} = 1\text{ mA}$,

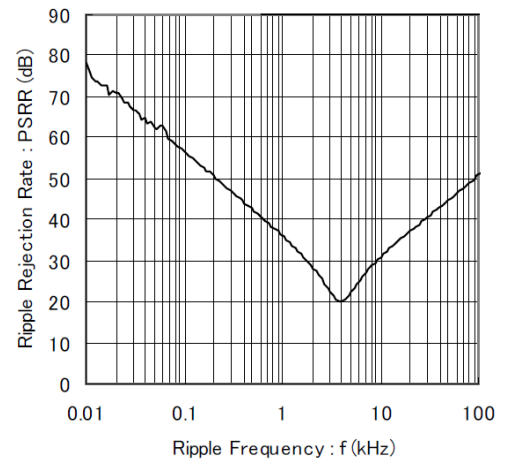

IXD1216B/D 502xx

$T_a = 25^\circ\text{C}$, $V_{IN} = V_{CE} = 7.0\text{ V} + 0.5\text{ Vp-pAC}$, $I_{OUT} = 1\text{ mA}$,

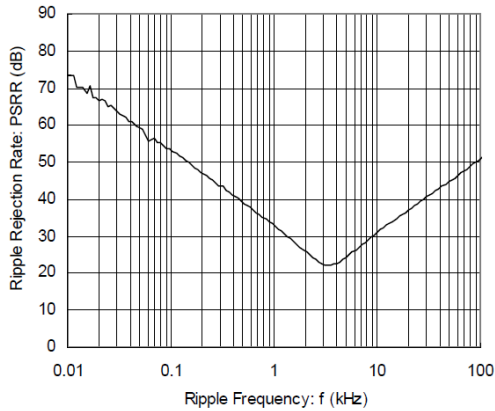

IXD1216B/D 502xx

$T_a = 25^\circ\text{C}$, $V_{IN} = V_{CE} = 7.0\text{ V} + 0.5\text{ Vp-pAC}$, $I_{OUT} = 1\text{ mA}$,

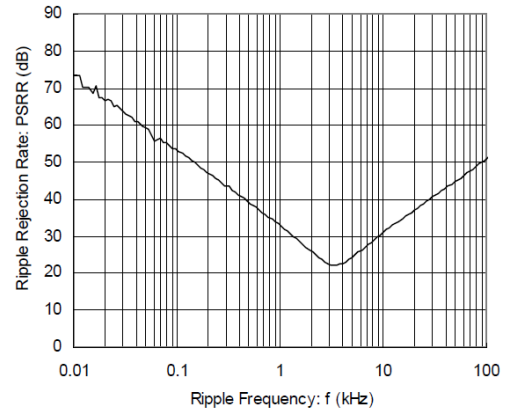

TYPICAL PERFORMANCE CHARACTERISTICS (Continued)

(10) Power Supply Ripple Rejection (Continued)

IXD1216B/D C02xx

T_A = 25°C, V_{IN} = V_{CE} = 7.0 V + 0.5 V_{p-pAC}, I_{OUT} = 1 mA,

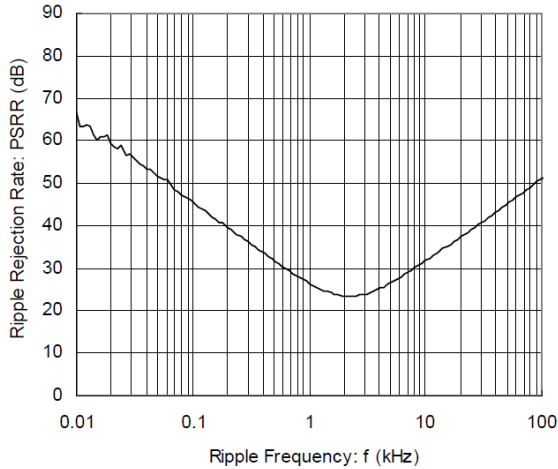

IXD1216B/D C02xx

T_A = 25°C, V_{IN} = V_{CE} = 7.0 V + 0.5 V_{p-pAC}, I_{OUT} = 30 mA,

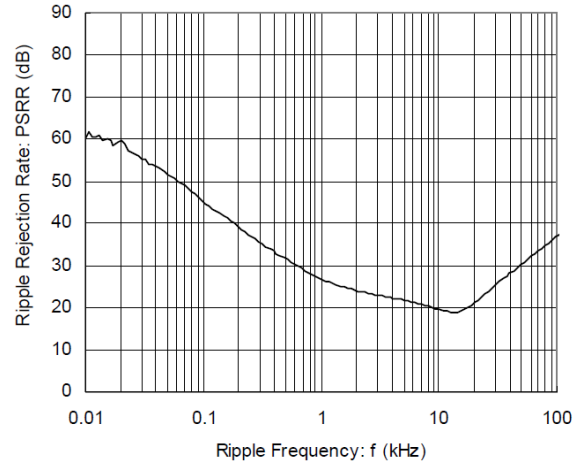

ORDERING INFORMATION

IXD1216①②③④⑤⑥-⑦

DESIGNATOR	DESCRIPTION	SYMBOL	DESCRIPTION
①	Type and Options	B	Fixed Output Voltage 2.0 – 12.0 V in 0.1 V increments, CE Function
		C	Output Voltage Set Externally (V _{FB} = 2.0 V), CE Function
		D	Fixed Output Voltage 2.0 – 12.0 V in 0.1 V increments, No CE function (3-pin regulator)
②③	Output Voltage	20 – C0	For voltages from 2.0 V to 9.9 V, e.g. 2.5 V - ① = 2, ② = 5; 5.0 V - ① = 5, ② = 0 For voltages from 10.0 V to 12.0 V, e.g. 10.6 V - ① = A ② = 6; 12.0 V - ① = C, ② = 0
④	Output Voltage Accuracy	2	Accuracy: ±2%
		1	Accuracy: ±1%
⑤⑥-⑦ (*)	Packages ¹⁾ (Order Limit)	MR	SOT-25 (3000/Reel)
		MR-G	SOT-25 (3000/Reel)
		PR	SOT-89, SOT-89-5 (1000/Reel)
		PR-G	SOT-89, SOT-89-5 (1000/Reel)
		ER	USP-6C (3000/Reel)
		ER-G	USP-6C (3000/Reel)
		FR	SOT-223 (1000/Reel)
		FR-G	SOT-223 (1000/Reel)
		JR	TO-252 (2500/reel)
		JR-G	TO-252 (2500/reel)
QR-G	SOP-8FD (1000/reel)		

NOTE:

The “-G” suffix denotes Halogen and Antimony free as well as being fully RoHS compliant.

- IXD1216B/C versions are available in SOT-25, SOT-89-5, USP-6C, and SOP-8FD packages only; IXD1216D version is available in SOT-89, SOT-223, and TO-252 packages only.

PACKAGE DRAWING AND DIMENSIONS

Units: mm

SOT-25

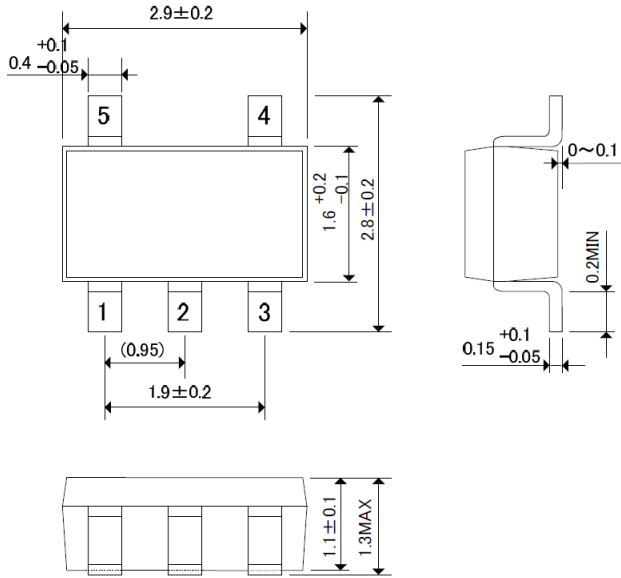

SOT-89

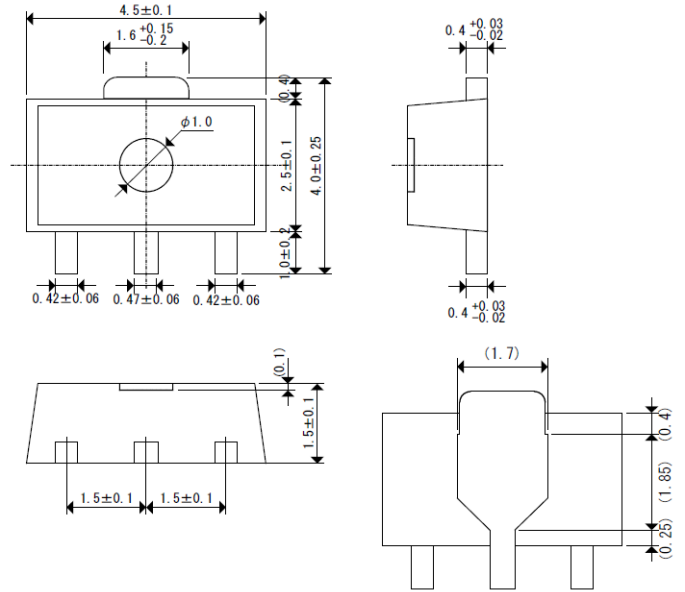

SOT-89-5

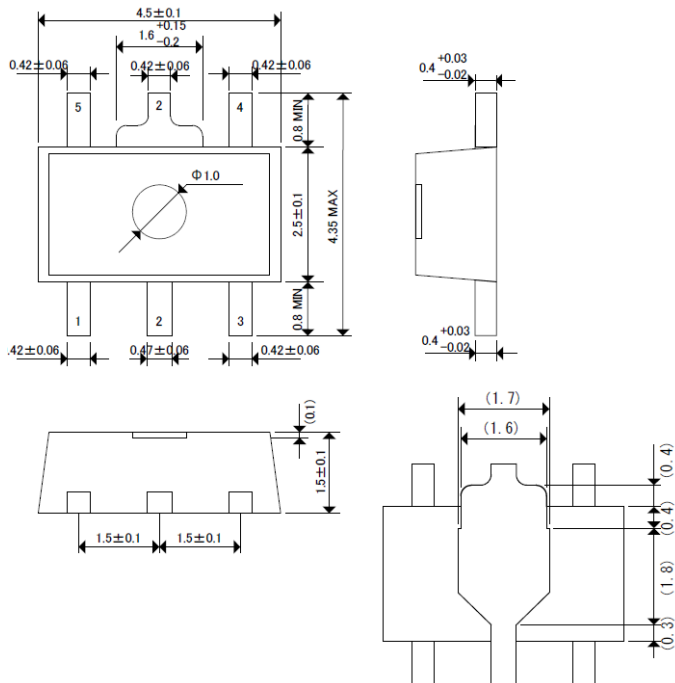

SOT-223

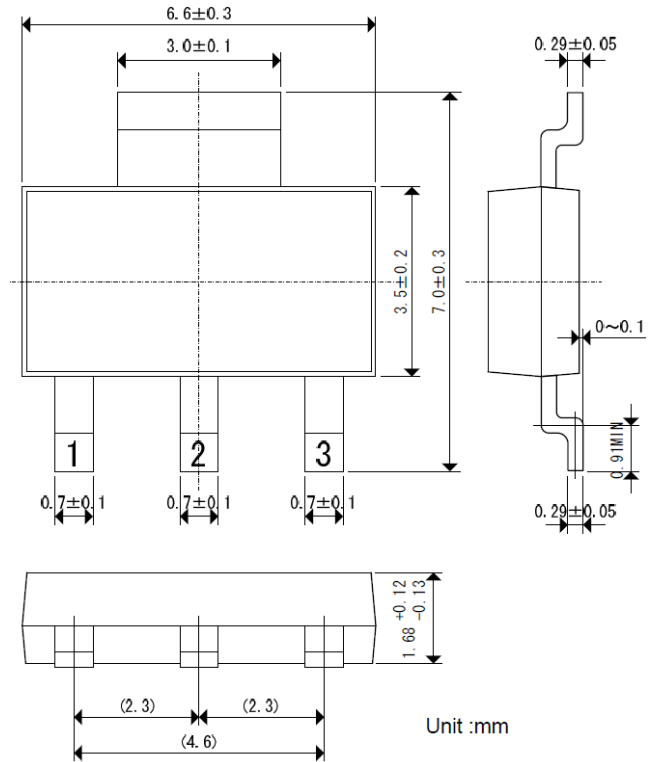

Unit: mm

PACKAGE DRAWING AND DIMENSIONS (CONTINUED)

Units: mm

TO-252

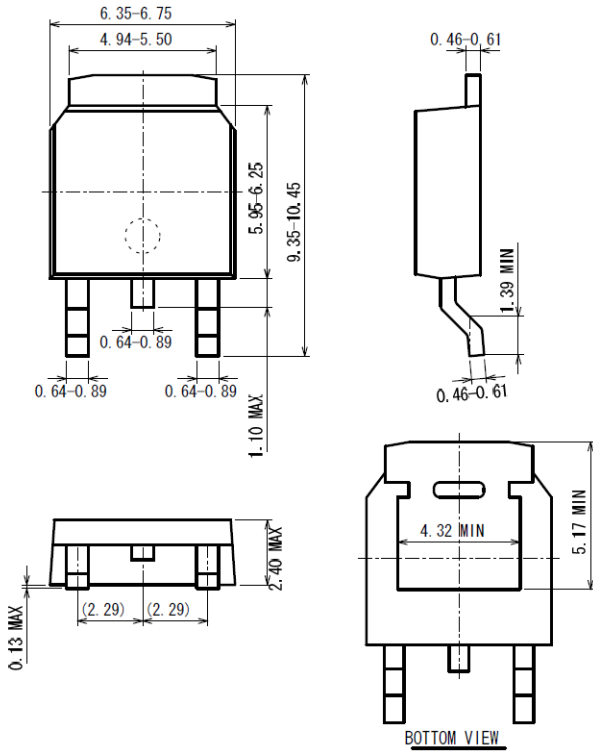

USP-6C

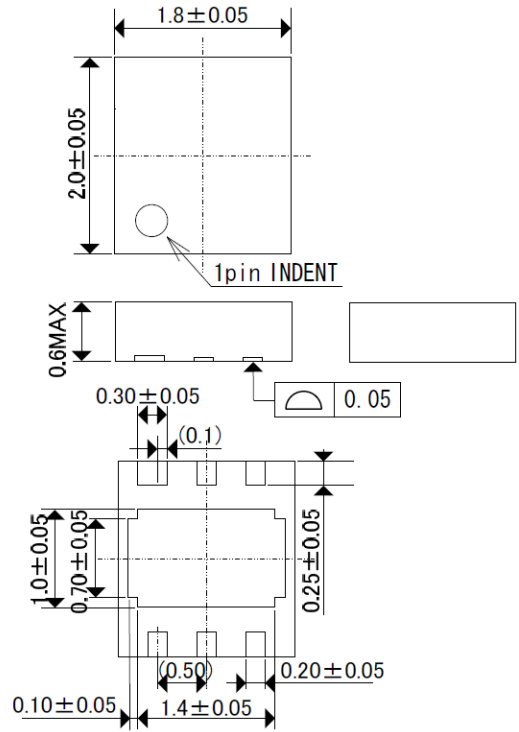

USP-6C Reference Pattern Layout

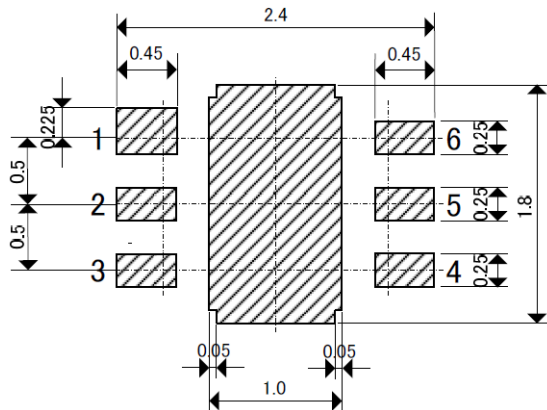

USP-6C Reference Metal Mask Design

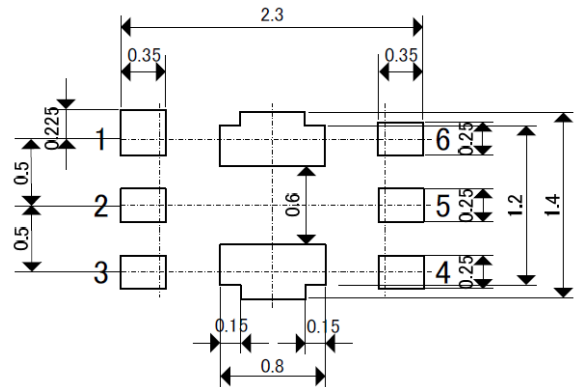

PACKAGE DRAWING AND DIMENSIONS (CONTINUED)

Units: mm

SOP-8FD

SOP-8FD Reference Pattern Layout

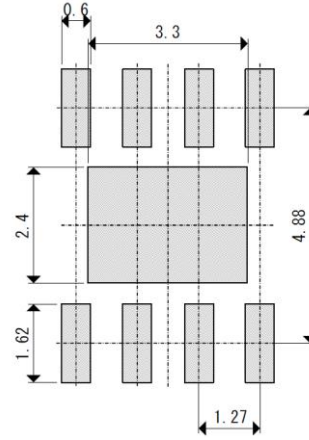
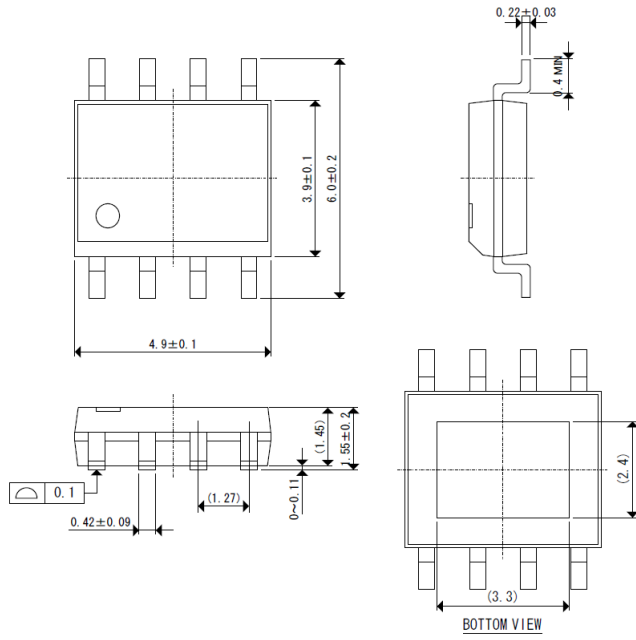

PACKAGE POWER DISSIPATION

SOT-25 Power Dissipation

The power dissipation varies with the mount board conditions. Please use this data as a reference only.

1. Measurement Conditions:

- Condition: Mount on a board
- Ambient: Natural convection
- Soldering: Lead (Pb) free
- Board: Dimensions 40x40 mm (1600 mm² in one side)
Copper (Cu) traces occupy 50% of the board area on top and bottom layers
Package heat sink tied to the copper traces.
(Board of SOT-26 is used)
- Material: Glass Epoxy (FR-4)
- Thickness: 1.6 mm
- Through-hole: 4 x 0.8 Diameter

2. Power Dissipation vs. Ambient Temperature

Board Mount (T_{jmax} = 125 °C)

Ambient Temperature, °C	Power Dissipation Pd, mW	Thermal Resistance, °C/W
25	600	166.67
85	240	

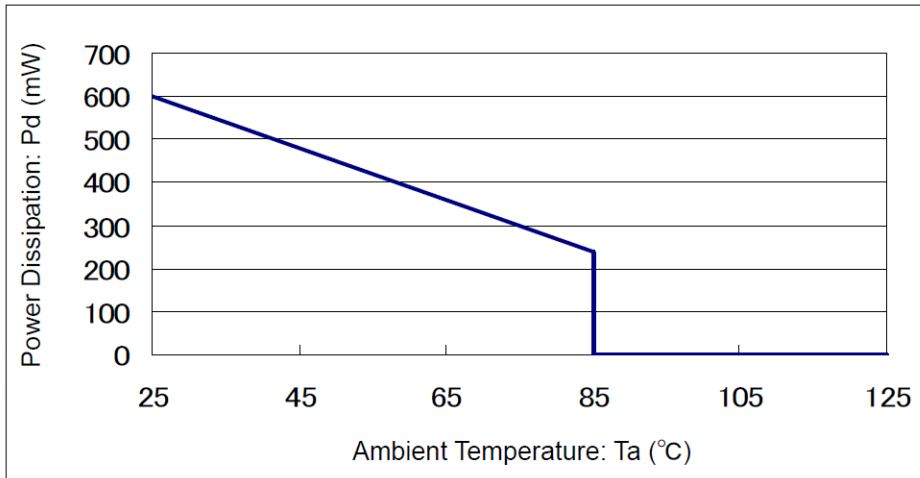
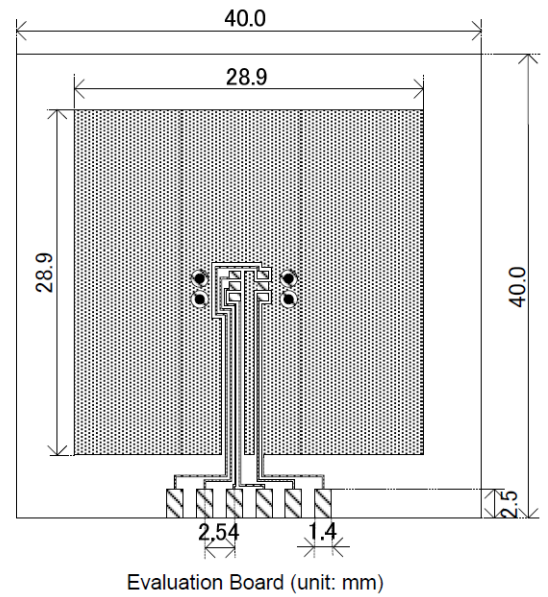

PACKAGE POWER DISSIPATION (CONTINUED)

SOT-89 Power Dissipation

The power dissipation varies with the mount board conditions. Please use this data as a reference only.

1. Measurement Conditions:

- Condition: Mount on a board
- Ambient: Natural convection
- Soldering: Lead (Pb) free
- Board: Dimensions 40x40 mm (1600 mm² in one side)
Copper (Cu) traces occupy 50% of the board area on top and bottom layers
Package heat sink tied to the copper traces.
- Material: Glass Epoxy (FR-4)
- Thickness: 1.6 mm
- Through-hole: 5 x 0.8 Diameter

2. Power Dissipation vs. Ambient Temperature
Board Mount (T_{jmax} = 125 °C)

Ambient Temperature, °C	Power Dissipation Pd, mW	Thermal Resistance, °C/W
25	1000	100.00
85	400	

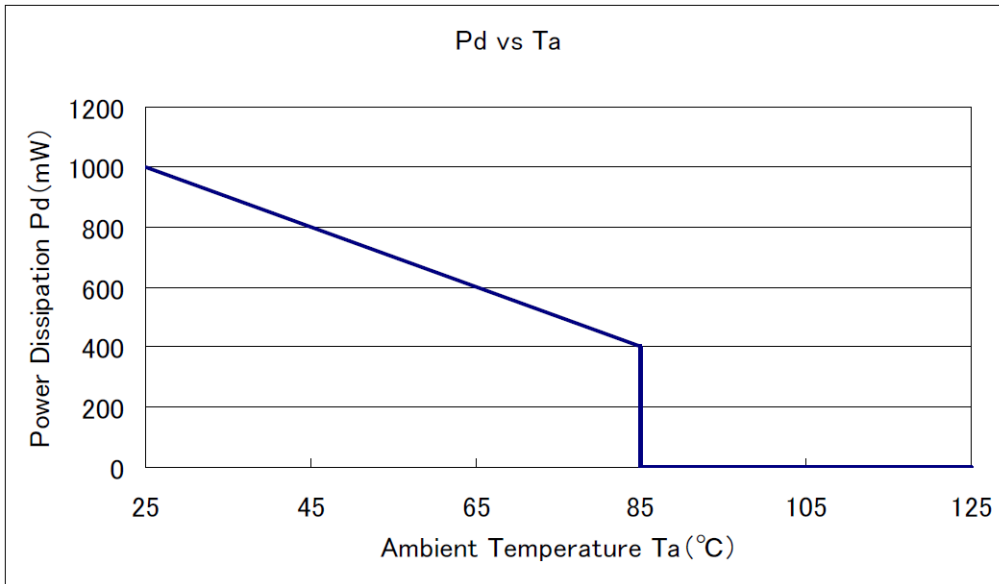
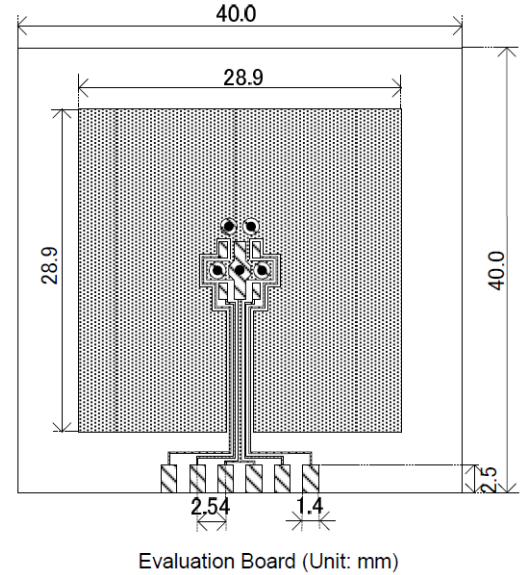

PACKAGE POWER DISSIPATION (CONTINUED)

SOT-89-5 Power Dissipation

The power dissipation varies with the mount board conditions. Please use this data as a reference only.

1. Measurement Conditions:

- Condition: Mount on a board
- Ambient: Natural convection
- Soldering: Lead (Pb) free
- Board: Dimensions 40x40 mm (1600 mm² in one side)
Copper (Cu) traces occupy 50% of the board area on top and bottom layers
Package heat sink tied to the copper traces.
- Material: Glass Epoxy (FR-4)
- Thickness: 1.6 mm
- Through-hole: 5 x 0.8 Diameter

2. Power Dissipation vs. Ambient Temperature

Board Mount (T_{jmax} = 125 °C)

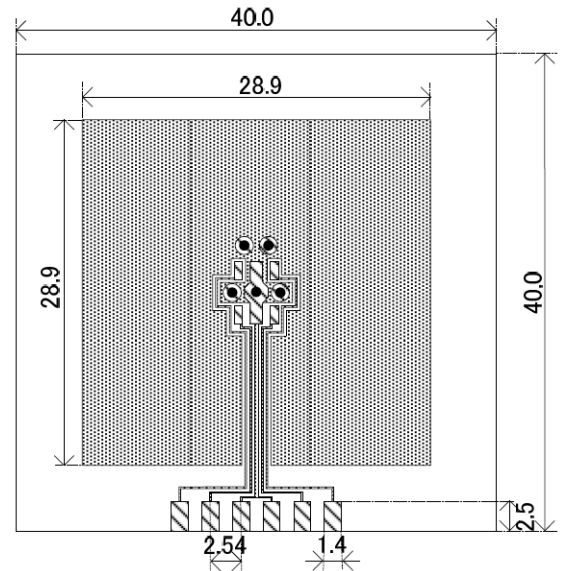

Evaluation Board (Unit: mm)

Ambient Temperature, °C	Power Dissipation Pd, mW	Thermal Resistance, °C/W
25	1300	76.92
85	500	

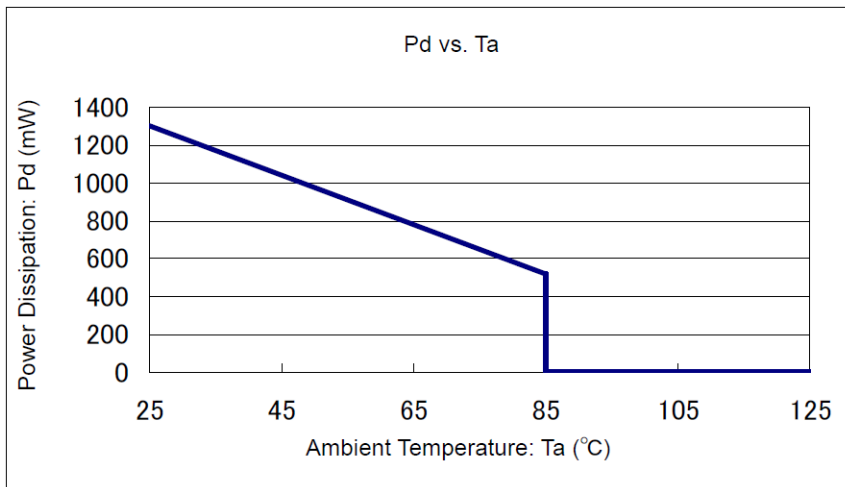

PACKAGE POWER DISSIPATION (CONTINUED)

USP-6C Power Dissipation

The power dissipation varies with the mount board conditions. Please use this data as a reference only.

1. Measurement Conditions:

- Condition: Mount on a board
- Ambient: Natural convection
- Soldering: Lead (Pb) free
- Board: Dimensions 40x40 mm (1600 mm² in one side)
Copper (Cu) traces occupy 50% of the board area
on top and bottom layers
Package heat sink teed to copper traces
- Material: Glass Epoxy (FR-4)
- Thickness: 1.6 mm
- Through-hole: 4 x 0.8 Diameter

2. Power Dissipation vs. Ambient Temperature
Board Mount (Tjmax = 125 °C)

Ambient Temperature, °C	Power Dissipation Pd, mW	Thermal Resistance, °C/W
25	1000	100.00
85	400	

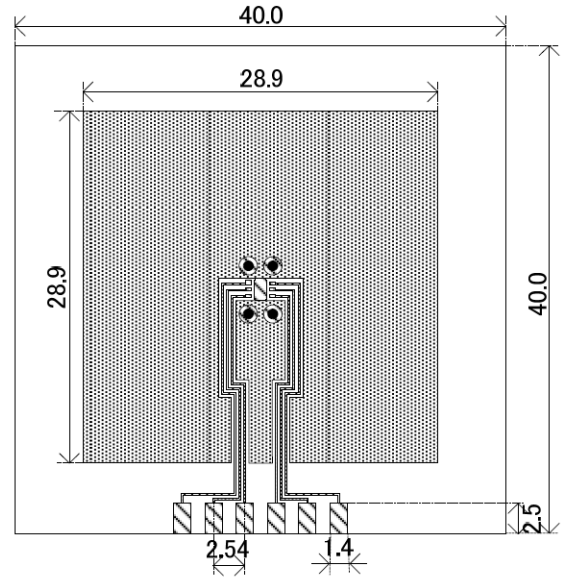

Evaluation Board (Unit: mm)

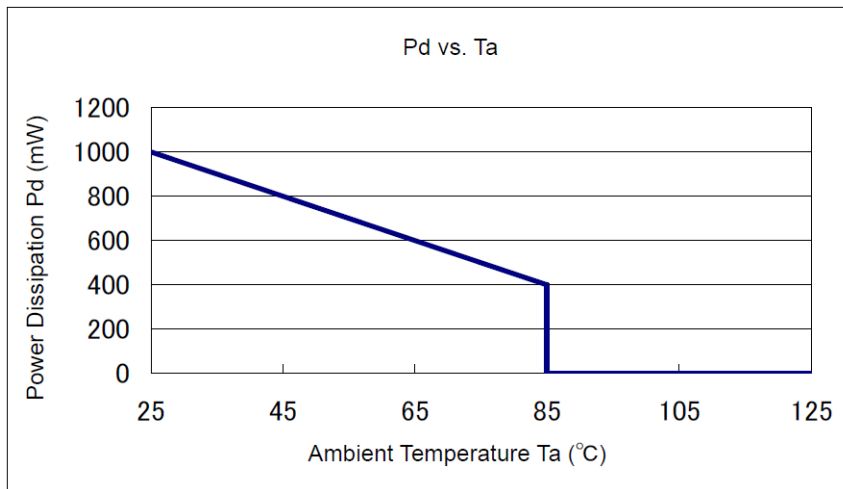

PACKAGE POWER DISSIPATION (CONTINUED)

SOT-223 Power Dissipation

The power dissipation varies with the mount board conditions. Please use this data as a reference only.

1. Measurement Conditions:

- Condition: Mount on a board
- Ambient: Natural convection
- Soldering: Lead (Pb) free
- Board: Dimensions 40x40 mm (1600 mm² in one side)
Copper (Cu) traces occupy 50% of the board area on top and bottom layers
Package heat sink tied to the copper traces.
- Material: Glass Epoxy (FR-4)
- Thickness: 1.6 mm
- Through-hole: 4 x 0.8 Diameter

2. Power Dissipation vs. Ambient Temperature

Board Mount (T_{jmax} = 125 °C)

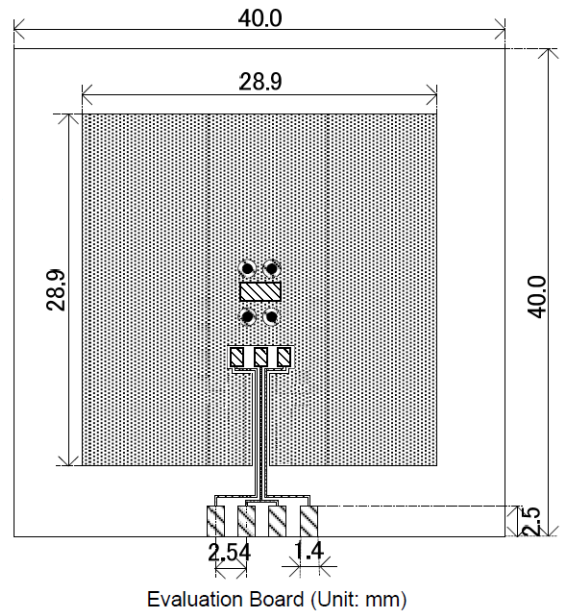

Ambient Temperature, °C	Power Dissipation Pd, mW	Thermal Resistance, °C/W
25	1500	66.67
85	600	

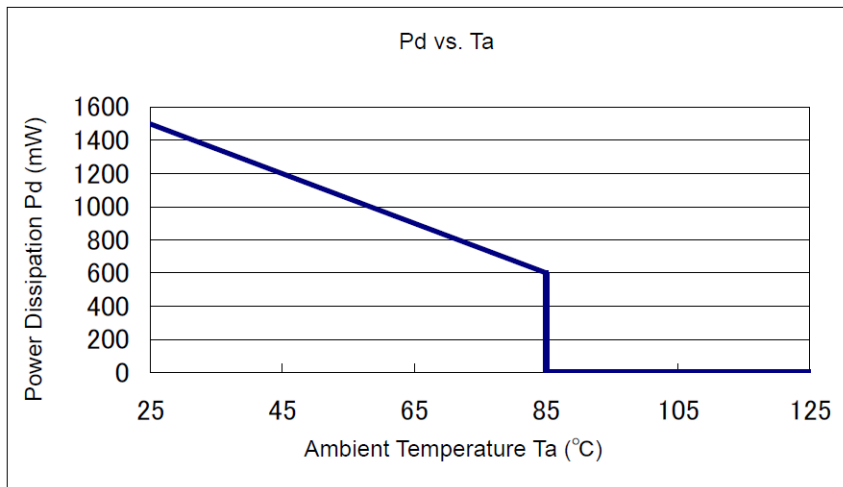

PACKAGE POWER DISSIPATION (CONTINUED)

TO-252 Power Dissipation

The power dissipation varies with the mount board conditions. Please use this data as a reference only.

1. Measurement Conditions:

- Condition: Mount on a board
- Ambient: Natural convection
- Soldering: Lead (Pb) free
- Board: Dimensions 40x40 mm (1600 mm² in one side)
Copper (Cu) traces occupy 50% of the board area on top and bottom layers
Package heat sink tied to the copper traces.
- Material: Glass Epoxy (FR-4)
- Thickness: 1.6 mm
- Through-hole: 4 x 0.8 Diameter

2. Power Dissipation vs. Ambient Temperature

Board Mount (T_{jmax} = 125 °C)

Ambient Temperature, °C	Power Dissipation Pd, mW	Thermal Resistance, °C/W
25	1800	55.56
85	720	

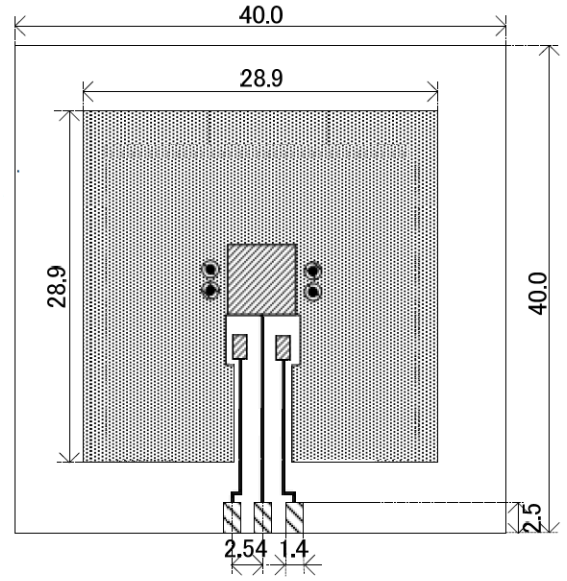

Evaluation Board (Unit: mm)

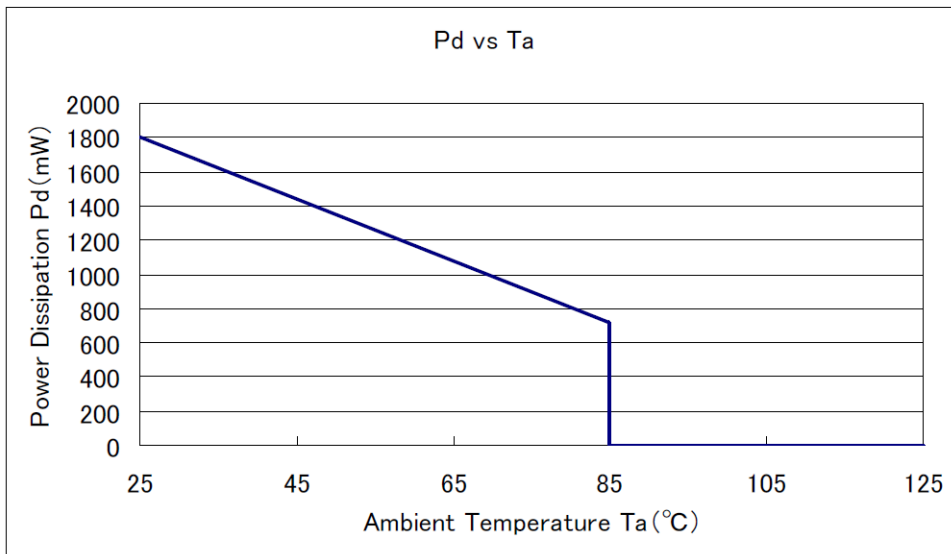

PACKAGE POWER DISSIPATION (CONTINUED)

SOP-8FD Power Dissipation

The power dissipation varies with the mount board conditions. Please use this data as a reference only.

1. Measurement Conditions:

- Condition: Mount on a board
- Ambient: Natural convection
- Soldering: Lead (Pb) free
- Board: Dimensions 40x40 mm (1600 mm² in one side)
Copper (Cu) traces occupy 50% of the board area on top and bottom layers
Package heat sink tied to the copper traces.
- Material: Glass Epoxy (FR-4)
- Thickness: 1.6 mm
- Through-hole: 4 x 0.8 Diameter

2. Power Dissipation vs. Ambient Temperature

Board Mount (T_{jmax} = 125 °C)

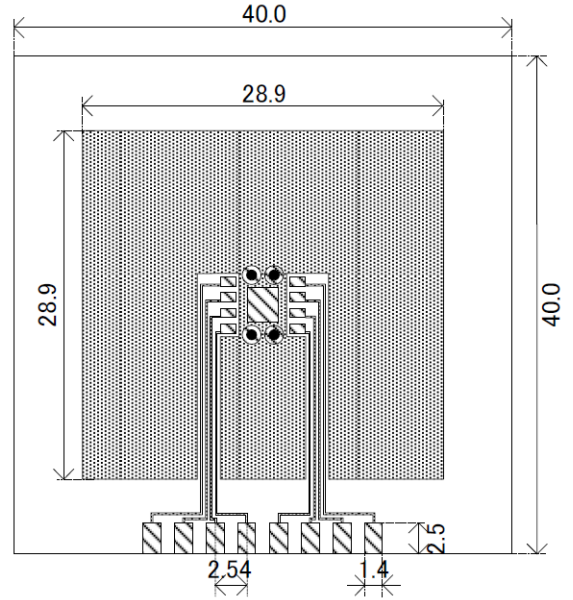

Evaluation Board (Unit: mm)

Ambient Temperature, °C	Power Dissipation Pd, mW	Thermal Resistance, °C/W
25	1500	66.67
85	600	

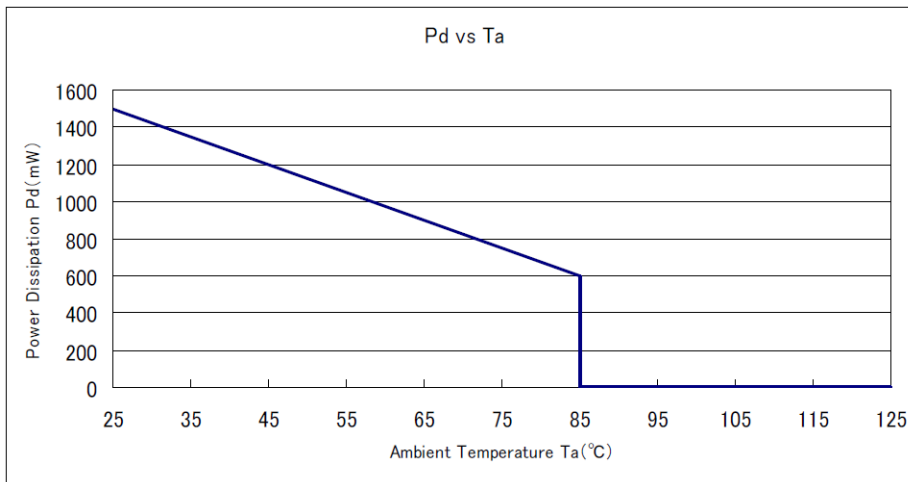

MARKING

SOT-25, SOT-89, SOT89-5, USP-4

SOT-25

SOT-89-5

SOT-89

USP-6C

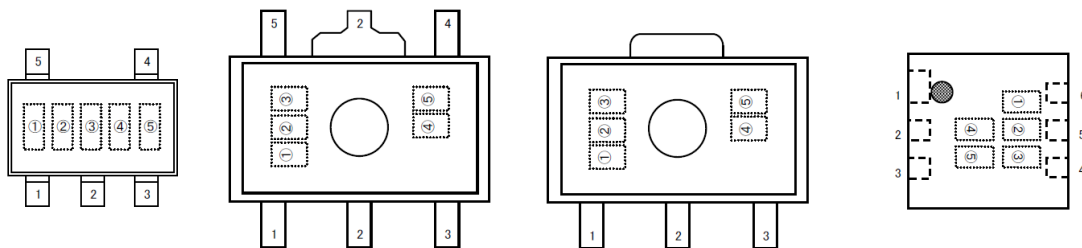

SOT-223

TO-252

SOP-8FD

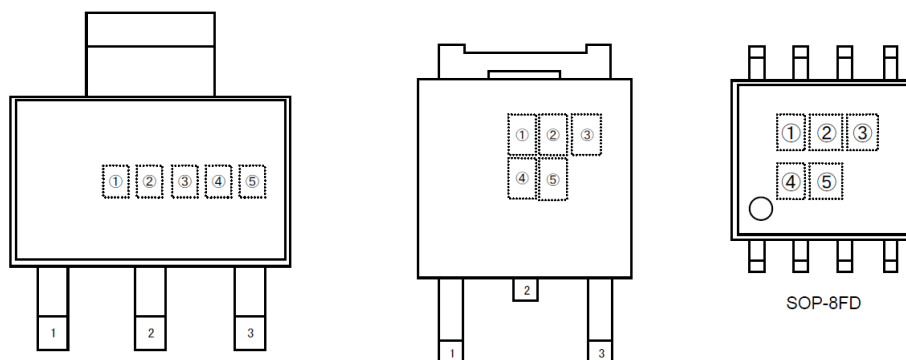

① - represents product series

MARK	PRODUCT SERIES
2	IXD1216xxxxx

② - represents type of regulator and output voltage range

MARK	TYPE	OUTPUT VOLTAGE, V	PRODUCT SERIES
0	B	2.0 – 3.0	IXD1216Bxxxx
1		3.1 – 6.0	
2		6.1 – 9.0	
3		9.1 - 12.0	
4	D	2.0 – 3.0	IXD1216Dxxxx
5		3.1 – 6.0	
6		6.1 – 9.0	
7		9.1 - 12.0	
8	C	2.0	IXD1216Cxxxx

MARKING (CONTINUED)

③ - represents output voltage

MARK	OUTPUT VOLTAGE, V						MARK	OUTPUT VOLTAGE, V			
0	-	3.1	6.1	9.1	12.1	15.1	F	-	4.6	7.6	10.6
1	-	3.2	6.2	9.2	12.2	15.2	H	-	4.7	7.7	10.7
2	-	3.3	6.3	9.3	12.3	15.3	K		4.8	7.8	10.8
3	-	3.4	6.4	9.4	12.4	15.4	L		4.9	7.9	10.9
4	-	3.5	6.5	9.5	12.5	15.5	M	2.0	5.0	8.0	11.0
5	-	3.6	6.6	9.6	12.6	15.6	N	2.1	5.1	8.1	11.1
6	-	3.7	6.7	9.7	12.7	15.7	P	2.2	5.2	8.2	11.2
7	-	3.8	6.8	9.8	12.8	15.8	R	2.3	5.3	8.3	11.3
8	-	3.9	6.9	9.9	12.9	15.9	S	2.4	5.4	8.4	11.4
9	-	4.0	7.0	10.0	13.0	16.0	T	2.5	5.5	8.5	11.5
A	-	4.1	7.1	10.1	13.1	16.1	U	2.6	5.6	8.6	11.6
B	-	4.2	7.2	10.2	13.2	16.2	V	2.7	5.7	8.7	11.7
C	-	4.3	7.3	10.3	13.3	16.3	X	2.8	5.8	8.8	11.8
D	-	4.4	7.4	10.4	13.4	16.4	Y	2.9	5.9	8.9	11.9
E	-	4.5	7.5	10.5	13.5	16.5	Z	3.0	6.0	9.0	12.0

④⑤ - represents production lot number

01~09, 0A~0Z, 11~9Z, A1~A9, AA~AZ, B1~ZZ in order, (G, I, J, O, Q, W excluded)

Customer Support

To share comments, get your technical questions answered, or report issues you may be experiencing with our products, please visit Zilog's Technical Support page at <http://support.zilog.com>. To learn more about this product, find additional documentation, or to discover other facets about Zilog product offerings, please visit the Zilog Knowledge Base at <http://zilog.com/kb> or consider participating in the Zilog Forum at <http://zilog.com/forum>. This publication is subject to replacement by a later edition. To determine whether a later edition exists, please visit the Zilog website at <http://www.zilog.com>.

Warning: DO NOT USE THIS PRODUCT IN LIFE SUPPORT SYSTEMS.

LIFE SUPPORT POLICY ZILOG'S PRODUCTS ARE NOT AUTHORIZED FOR USE AS CRITICAL COMPONENTS IN LIFE SUPPORT DEVICES OR SYSTEMS WITHOUT THE EXPRESS PRIOR WRITTEN APPROVAL OF THE PRESIDENT AND GENERAL COUNSEL OF ZILOG CORPORATION.

As used herein Life support devices or systems are devices which (a) are intended for surgical implant into the body, or (b) support or sustain life and whose failure to perform when properly used in accordance with instructions for use provided in the labeling can be reasonably expected to result in a significant injury to the user. A critical component is any component in a life support device or system whose failure to perform can be reasonably expected to cause the failure of the life support device or system or to affect its safety or effectiveness.

Document Disclaimer ©2015 Zilog, Inc. All rights reserved. Information in this publication concerning the devices, applications, or technology described is intended to suggest possible uses and may be superseded. ZILOG, INC. DOES NOT ASSUME LIABILITY FOR OR PROVIDE A REPRESENTATION OF ACCURACY OF THE INFORMATION, DEVICES, OR TECHNOLOGY DESCRIBED IN THIS DOCUMENT. ZILOG ALSO DOES NOT ASSUME LIABILITY FOR INTELLECTUAL PROPERTY INFRINGEMENT RELATED IN ANY MANNER TO USE OF INFORMATION, DEVICES, OR TECHNOLOGY DESCRIBED HEREIN OR OTHERWISE. The information contained within this document has been verified according to the general principles of electrical and mechanical engineering.