



LED Display Product Data Sheet LTS-30301HRB

Spec No.: DS30-2000-071

Effective Date: 04/19/2000

Revision: -

LITE-ON DCC

RELEASE

BNS-OD-FC001/A4

FEATURES

- * 3-INCH (76.2-mm) DIGIT HEIGHT.
- * CONTINUOUS UNIFORM SEGMENTS.
- * LOW POWER REQUIREMENT.
- * EXCELLENT CHARACTERS APPEARANCE.
- * HIGH BRIGHTNESS & HIGH CONTRAST.
- * WIDE VIEWING ANGLE.
- * SOLID STATE RELIABILITY.
- * CATEGORIZED FOR LUMINOUS INTENSITY.

DESCRIPTION

The LTS-30301HRB is a 3-inch (76.2-mm) height single digit seven-segment display. This device utilizes orange LED chips, which are made from GaAsP on a transparent GaP substrate, and has a black face and red segments.

DEVICE

PART NO.	DESCRIPTION
HI-EFF. RED	Common Cathode
LTS-30301HRB	Rt. Hand Decimal

PACKAGE DIMENSIONS

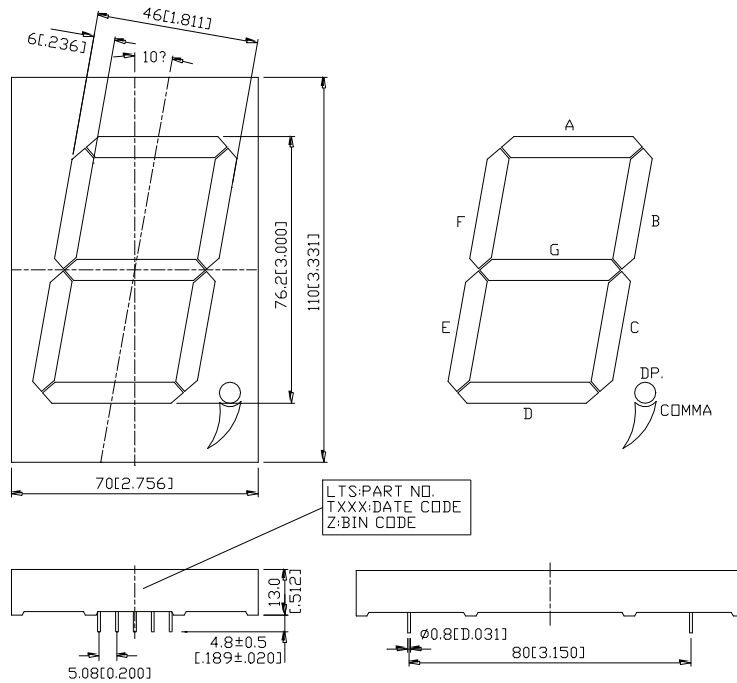

NOTES: All dimensions are in millimeters. Tolerance is $\pm 0.25\text{mm}(0.01\text{'})$ unless otherwise noted.

INTERNAL CIRCUIT DIAGRAM

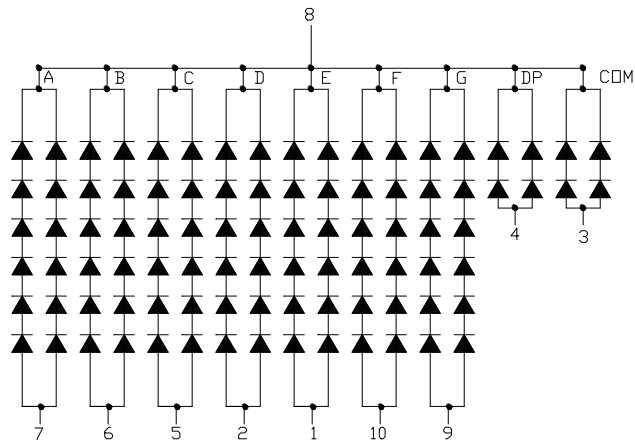

Property of Lite-on Only

PIN CONNECTION

No	CONNECTION
1	SEGMENT E ANODE
2	SEGMENT D ANODE
3	COMMA ANODE
4	D.P. ANODE
5	SEGMENT C ANODE
6	SEGMENT B ANODE
7	SEGMENT A ANODE
8	COMMON CATHODE
9	SEGMENT G ANODE
10	SEGMENT F ANODE

ABSOLUTE MAXIMUM RATING AT T_A=25°C

PARAMETER	MAXIMUM RATING	UNIT
Power Dissipation Per Segment	650	mW
Peak Forward Current Per Segment (1/10 Duty Cycle, 0.1ms Pulse Width)	160	mA
Continuous Forward Current Per Segment	40	mA
Derating Linear From 25°C Per Segment	0.48	mA/°C
Reverse Voltage Per Segment	30	V
Operating Temperature Range	-35°C to +85°C	
Storage Temperature Range	-35°C to +85°C	
Solder Temperature 1/16 inch Below Seating Plane for 3 Seconds at 260°C		

ELECTRICAL / OPTICAL CHARACTERISTICS AT T_A=25°C

PARAMETER	SYMBOL	MIN.	TYP.	MAX.	UNIT	TEST CONDITION
Average Luminous Intensity	I _v	13000	30000		μcd	I _F =20mA
Peak Emission Wavelength	λ _p		635		nm	I _F =40mA
Spectral Line Half-Width	Δλ		40		nm	I _F =40mA
Dominant Wavelength	λ _d		623		nm	I _F =40mA
Forward Voltage. Per Segment Or D.P.	V _F		12.0 (4.0)	15.6 (5.2)	V	I _F =40mA
Reverse Current, Per Segment Or D.P.	I _R			200	μA	V _R =30V
Luminous Intensity Matching Ratio	I _v -m			2:1		I _F =20mA

Note: Luminous intensity is measured with a light sensor and filter combination that approximates the CIE (Commission Internationale De L'Eclairage) eye-response curve.

Property of Lite-on Only

TYPICAL ELECTRICAL / OPTICAL CHARACTERISTIC CURVES

(25°C Ambient Temperature Unless Otherwise Noted)

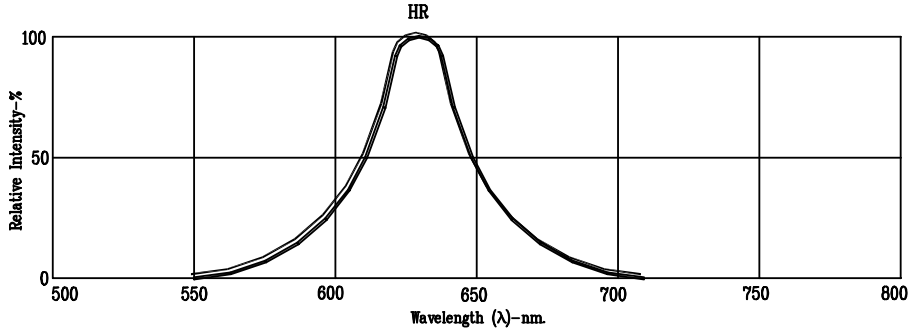

Fig1. RELATIVE INTENSITY VS. WAVELENGTH

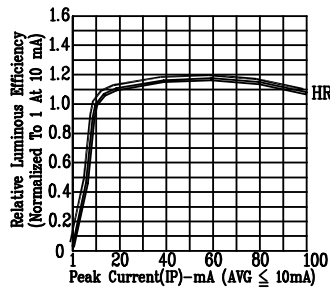

Fig2. RELATIVE LUMINOUS EFFICIENCY (LUMINOUS INTENSITY PER UNIT CURRENT) VS. PEAK CURRENT (REFRESH RATE 1KHz)

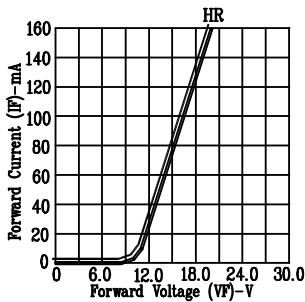

Fig3. FORWARD CURRENT VS. FORWARD VOLTAGE

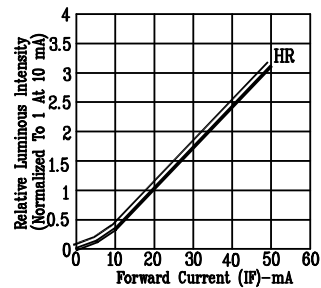

Fig4. RELATIVE LUMINOUS INTENSITY VS. FORWARD CURRENT

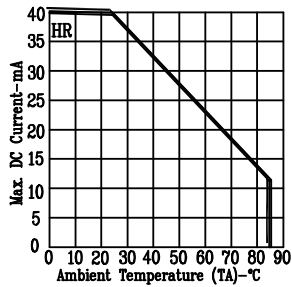

Fig5. MAX. ALLOWABLE DC CURRENT VS. AMBIENT TEMPERATURE.

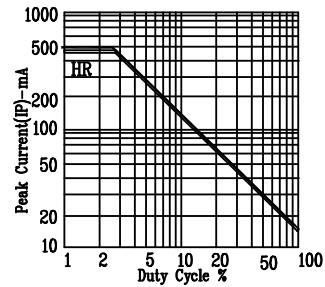

Fig6. MAX. PEAK CURRENT VS. DUTY CYCLE % (REFRESH RATE 1KHz)

NOTE: HR=HL-EFF.RED