





Product Category	Page(s)
New At Aven	3-10
Digital Microscopes	11-12
Stereo Zoom Microscopes	13- 18
Video Inspection Systems	19 - 22
Microscope & Video Accessories	23- 31
Magnifiers	32 - 34
Magnifying Lamps & Accessories	35- 37
Work Lights	38
Hand Tools	39 - 45
Precision Cutters & Pliers	46 - 50
Tweezers	51 - 58
Soldering & Desoldering	59 - 61



### SharpVue HD Video Inspection System

Futuristic, Innovative and Easy to Use

The SharpVue features an auto focus HD camera with optical magnification of up to 20x or 30x, and digital magnification up to 300x depending on the lens used. The SharpVue produces high quality 1080p HD images without any distortion or delay and with excellent depth of field. The built in LED lights ensures shadow-free illumination even when viewing shiny objects. The SharpVue features a large working distance of 9 inches, ensuring that objects of any size can be inspected. This system is operated with the included wireless remote. Zoom in and out, turn auto focus on or off, insert a cross hair, fine tune your focus, and much more all with a touch of a button.

Includes HDMI and USB outputs. Connect the SharpVue to your computer via USB cable to utilize the included imaging and measurement software.

Item#	Description
26700-135	SharpVue Video Inspection System
Magnification	20x and 30x
Resolution	1080p (monitor) / 720p (Computer)
Zoom	20x Optical, 12x Digital
Output	USB / HDMI
Lighting	Built-in angled LED
Focus	Auto/Manual
Image/Video	With imaging software
Dimensions	16.14" x 6.7" x 13.78"
Weight	9.9 lbs
Package Contents	Aven Sharpvue system, Imaging Software, wireless remote control

# SharpVue Video Inspection System

## Modern Design, Ease Of Use

Aven's SharpVue system is designed to inspect, capture images and video, and much more with ease. Adjust your settings with the included easy-to-use remote control.



## Built-In Features



Built-in LED lights for shadow-free illumination



### USB and HDMI outputs.

Connect to your monitor for lag-free 1080p inspection with the HDMI port. Or use the USB port to connect to your PC.

## Premium Accessories

The SharpVue offers crystal-clear 1080p imaging, with a magnification of up to 30x optical zoom, 300x Digital zoom. View your images on an HD monitor, eliminating the eye strain and fatigue from frequent microscope use.

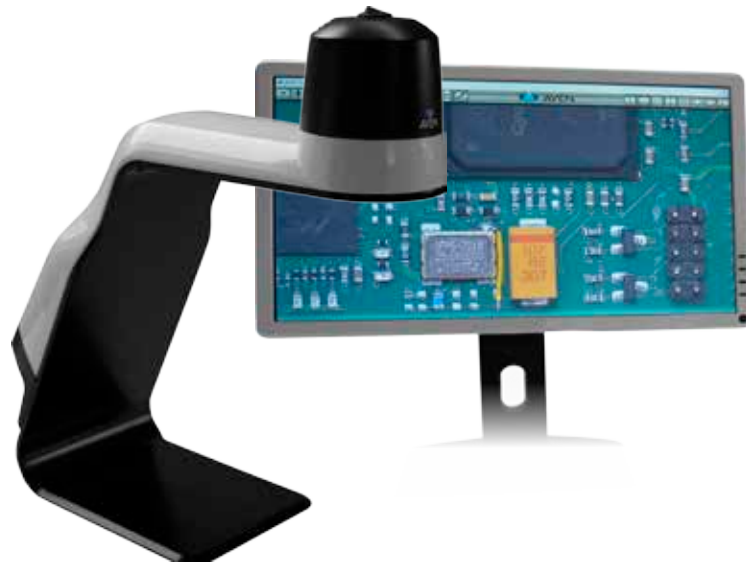

For more information on SharpVue accessories visit [aveninc.com](http://aveninc.com)



SharpVue X-Y Sliding Table  
Item # 26700-135-XYTB



SharpVue Tilttable  
Item # 26700-135-TTB



Image Capture Box  
Item # 26700-401-CB



LCD 1080p Monitor  
Item # 26700-406

# Cyclops HDMI Digital Microscope



\*\*monitor not included

This innovative inspection scope connects directly to an HD monitor through a convenient 1080p HDMI output allowing operators to view high quality magnified images while looking straight ahead at a large screen, rather than hunching over narrow eyepieces. A large working distance and 30 LEDs that can be adjusted for intensity allow examination of objects of various sizes. Magnification ranges up to 132x on a 21.5" HD monitor.

This breakthrough instrument increases accuracy and productivity while easing eye strain and user fatigue from frequent microscope use, valuable benefits in high-volume applications.

## Features

- 2-megapixel sensor
- HDMI output connects directly to an HD monitor
- 30 energy-efficient LED illumination with intensity control
- Up to 132x Magnification
- Infrared remote control for all major features

### Cyclops HDMI Digital Microscope

<b>Effective Pixels</b>	2M Pixels
<b>Image Sensor</b>	CMOS Color
<b>Frames Per Second</b>	30FPS
<b>Magnification / Zoom</b>	Up to 132x
<b>LED Lighting</b>	30 White LEDs with brightness & sector control
<b>Video Output</b>	1920x1080p HD
<b>Gain Control</b>	Automatic
<b>Power Source</b>	DC 5A/2A input; Cable length: 180cm
<b>Power Consumption</b>	0.225A (MAX)
<b>Dimensions</b>	106 x 152 mm
<b>Weight</b>	0.70 lbs.   310g

Part #	Description	Price
<b>26700-401</b>	Cyclops HDMI Digital Microscope	\$750.00



# Cyclops Digital Microscope

Accessories



## Objective Lenses

Aven offers optional objective lenses to make your Cyclops system even more versatile.

### Cyclops 4x Long Focus Lens

Item # 26700-400-L4XLF

Provides operators with a working distance of approximately 95mm - 218mm. (3.75 - 8.5 inches)



### Cyclops Objective Lens 10X

Item # 26700-400-L10X

Use of this lens will increase magnification, allowing even further clarity for examining small objects. Includes lighting attachment.



### Cyclops Objective Lens 4X with Polarizer

Item # 26700-400-PL01

Aiding in the illumination and study of small and shiny parts, this polarized lens reduces problematic glare.



## Cyclops Articulating Arm Stands

Available with 17 inch and 12 inch posts, the Cyclops Articulating Arm Stands clamp to the side of your work bench and provide diverse positioning options.



### Cyclops Articulating Arm Stand, Post Height 17-in

Item # 26700-410-C18

17" post and an adjustable swivel arm provide versatile positioning options.



### Cyclops Articulating Arm Stand, Post Height 12-in

Item # 26700-410-C15

12" post and an adjustable swivel arm provide versatile positioning options.

## Add-Ons

Complete your Cyclops system with with these premium add-ons

### 22" LCD Monitor

Item # 26700-406

Outstanding performance, eco-friendliness and smart use of energy complement the sleek design. LED Back-lit with 50,000,000:1 Smart Contrast Ratio, Full 1080P with HDMI.



### Cyclops Laser Pointer

Item # 26700-400-GN02

Provides a constant laser point to highlight exact areas for display or inspection. Attaches to the Cyclops stand. Includes light intensity control.



## Monitor Mounts

Aven's Monitor Mounts clamp to the side of your work bench and provide diverse positioning options. Available with 17 inch and 12 inch posts.



# ProVue Deluxe LED Magnifying Lamp

## Efficient and Powerful



The innovative ProVue Deluxe LED Magnifying lamp from Aven is the new standard in inspection lighting. This durable aluminum design features a 5 inch, 5 diopter glass lens for crystal clear, distortion-free viewing. Featuring 72 energy-efficient LED lights for shadow-free illumination.

The 36" adjustable friction arm provides a large working range. Simply set your lamp position and lock it in. No springs, no exposed wires and no pinching hazards. The lamp head rotates in any direction to suit your inspection needs, and the convenient built-in dimmer allows you to control the lamp brightness.

PROVUE DELUXE LED	
MAGNIFICATION	2.25X (5-Diopter)
LENS DIAMETER	5in
ADJUSTABLE ARM LENGTH	36in
COLOR	Brushed Silver
LIGHTING	72 LED Lights

Part #	Description	Lens
26501-DSG-LED	ProVue Deluxe LED Magnifying Lamp	5 Diopter

## Mighty Vue Deluxe LED Magnifying Efficient and Powerful



7 Inch/ 5 Diopter Lens  
2.25x Magnification



Dual- Row, 72 Energy-Efficient LED Lights  
For Shadow-Free Illumination



Heavy-Duty Mounting Clamp

MIGHTY VUE DELUXE LED	
MAGNIFICATION	2.25X (5-Diopter)
LENS DIAMETER	7in
ADJUSTABLE ARM LENGTH	36in
COLOR	Brushed Silver
LIGHTING	72 LED Lights

The innovative Mighty Vue Deluxe LED Magnifying lamp from Aven is the new standard in inspection lighting. This durable aluminum design features a large 7 inch, 5 diopter glass lens for crystal clear, distortion-free viewing. This deluxe lamp also includes dual-row 72 energy-efficient LED lights for shadow-free illumination.

The 36" adjustable friction arm provides a large working range. Simply set your lamp position and lock it in. No springs, no exposed wires and no pinching hazards. The lamp head rotates in any direction to suit your inspection needs, and the convenient touch-sensitive dimmer control offers 5 brightness settings.

## ESD Safe Soldering Stations



Compact & Convenient Soldering

Part #	Description	Price
17400	Soldering Station with LCD Display ESD Safe 400 Series	\$134.95
Part #	Description	Price
17405	Soldering Station with LCD Display ESD Safe	\$54.95

ADDITIONAL TIPS	
17400-N91	
17400-N92	
17400-N93	
17400-N94	
17400-N95	

## Soldering Iron 80W with Fine Tip



This professional grade soldering iron produces 80 watts (up to 500 °C) and is ideal for general purpose soldering applications including metal board, tube or large components, electrical/electronic components, audio equipment, RC hobbies and more.

SOLDERING IRON 80W WITH FINE TIP		
POWER	80W	
TEMPERATURE	Up to 500°C (932°F)	
DIMENSIONS	285mm x 35mm x 35mm (11.25" x 1.375" x 1.375")	
TIP	Fine	
POWER SOURCE	Corded Electrical	
WEIGHT	0.2kg (0.45 lbs)	
PACKAGE CONTENTS	Soldering Iron 80W with Fine Tip	
Part #	Description	Price
17510	Soldering Iron 80W with Fine Tip	\$16.50



# Mighty Cam 3.0 USB Camera

## Experience USB 3.0 Speed

Aven's **Mighty Cam 3.0** is the new generation **USB3.0** camera. Capable of frame rates more than double of **USB 2.0** devices, the **Mighty Cam 3.0** is ideal for applications that require reduced image lag times. Simply attach the **Mighty Cam 3.0** to your microscope, plug in the **USB 3.0** cable and connect to your computer. Includes **ezMeasure** software to capture stunning images, record video, make accurate measurements and more.

Part #	Description	Sensor
26100-244	Mighty Cam 3.0	CMOS

## New At Aven



- ▶ USB 3.0 interface provides high speed image transfer rates.
- ▶ Automatic/Manual White Balance
- ▶ Progressive Scan
- ▶ USB cable plugs into any computer to save, process and share images
- ▶ Windows 7 & 8-compatible ezMeasure Software
- ▶ Ideal for applications that require reduced lag times

# Mighty Cam CCD USB Camera

## See the CCD Difference

The **Mighty Cam CCD** is designed for challenging lighting and color conditions. The **CCD** sensor provides precise color reproduction and highly detailed images for your demanding applications. The **Mighty Cam CCD** is capable of high resolution images with low noise and can precisely capture moving objects.

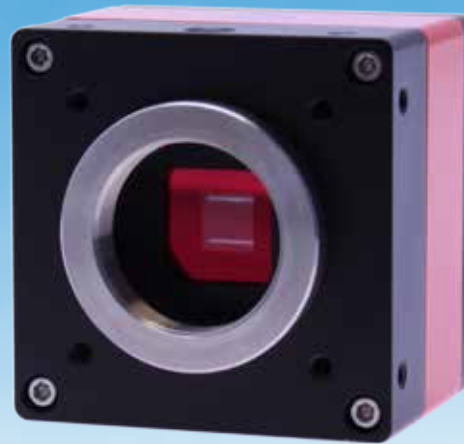

- ▶ 1/2" 1.4MP Color CCD Sensor provides crisp images with accurate color
- ▶ Automatic/Manual White Balance
- ▶ Progressive Scan
- ▶ USB cable plugs into any computer to save, process and share images
- ▶ Windows 7 & 8-compatible ezMeasure Software
- ▶ Ideal for challenging lighting and color conditions

Part #	Description	Sensor
26100-245	Mighty Cam CCD	CCD

# Digital Microscopes

Inspect, analyze & measure with ease on your PC

## Mighty Scope USB Digital Microscopes

- ▶ New Models available with 1.3 and 5MP CMOS sensor
- ▶ Active Pixel Technology produces sharp and accurate color images
- ▶ Microtouch shutter allows for quick and convenient image capture
- ▶ Compatible with Windows and Mac
- ▶ 10-200x, 500x, UV and Near Infrared models
- ▶ Ergonomic design allows comfortable use in either hand
- ▶ Includes measurement software and adjustable metal stand
- ▶ 10-200x available with polarizer



"Inspect, analyze, measure easily on your laptop"

Product ID	Description
26700-200	Mighty Scope 1.3M USB Digital Microscope (10x-200x)
26700-200-PLR	Mighty Scope 1.3M USB Digital Microscope w/Polarizer (10x-200x)
26700-204	Mighty Scope 1.3M USB Digital Microscope (500x)
26700-205	Mighty Scope 1.3M USB Digital Microscope w/ UV Illumination (10x-200x)
26700-207	Mighty Scope 5M USB Digital Microscope w/NIR Illumination (10x-200x)
26700-209	Mighty Scope 5M USB Digital Microscope (10x-200x)
26700-209-PLR	Mighty Scope 5M USB Digital Microscope with Polarizer (10x-200x)
26700-216	Mighty Scope 1.3M Polarizer
26700-217	Mighty Scope 5M Polarizer

## Mighty Scope Analog Microscope

- ▶ Easy to use 6-LED compact & handy analog microscope with RCA outputs
- ▶ Ideal for applications where it is not feasible to have a PC, such as assembly lines and workbenches with space limitations
- ▶ High resolution magnification at your fingertips
- ▶ Detailed examination of any area you choose
- ▶ Active Pixel Technology produces sharp images and accurate color reproduction
- ▶ LED's can be turned on or off with brightness control wheel on the body
- ▶ Magnification range from 10x to 50x



Product ID	Description
26700-202	Mighty Scope 0.3M Analog Microscope (10x-50x)



## Mighty Scope Connect Wi-Fi Digital Microscope

- ▶ 6-inch-long microscope can be hand-held or stand-mounted
- ▶ 10x to 80x magnification, controlled by changes in working distance
- ▶ Creates wi-fi hotspot with 30-foot range
- ▶ Works with Androids, Apple iOS tablets and phones
- ▶ Snap button on body saves high-quality images



"Compact scope links wirelessly to tablets, phones"

\* iPad not included

Product ID	Description
26700-201	Mighty Scope Connect Wi-Fi Digital Microscope (10x-80x)

## iLoupe XL2 Digital Microscope

- ▶ Large 2.8" LCD color screen
- ▶ Built-in 2 gigabyte flash memory
- ▶ 4 white LED lights with brightness control
- ▶ Magnification: 10x, 40x (optical) 15x to 200x (digital)
- ▶ USB port and cable for computer link and charging
- ▶ Adjustable-height stand
- ▶ Lithium-ion battery
- ▶ Advanced application software



"Discover the Micro World"

Product ID	Description
26700-520	iLoupe XL2 Digital Microscope

## zipScope USB Digital Microscopes

- ▶ New models available with 2 and 9 MP CMOS sensor
- ▶ Anti-slip coating engineered for comfort and cushioning
- ▶ 2-stage intensity control of 8 LEDs for shadow-free lighting
- ▶ USB cable plugs into any computer to save, process and share images
- ▶ Snapshot button conveniently captures crisp, clear, true-color images
- ▶ Windows-compatible measurement and imaging software
- ▶ Broad magnification range (10x - 200x)
- ▶ Ideal for general inspection and use in labs, medical offices, classrooms and by hobbyists



Product ID	Description
26700-300	zipScope 2M USB Digital Microscope
26700-302	zipScope 9M USB Digital Microscope



# Digital Microscopes

Inspect, analyze & measure with ease on your PC

## Cyclops Digital Microscope

This innovative inspection scope connects directly to an HD monitor as well as to a computer. Operators observe magnified videos or single frames while looking directly at the monitor, rather than straining over narrow eyepieces. A large working distance and 30 LEDs allow examination of sizable objects. Magnification ranges up to 270x on a 21.5" extended monitor or 534x for PC viewing.

- ▶ Dual output HDMI and USB
- ▶ Auto Focus enabled
- ▶ Designed to maximize efficiency and operator comfort
- ▶ 5-megapixel sensor
- ▶ High magnification range and extended working distance
- ▶ Up to 273x magnification in HDMI mode and 534x in PC mode
- ▶ LED illumination with intensity control
- ▶ Infrared remote control for all major features
- ▶ Includes standard 4x objective lens and measurement software
- ▶ Optional articulating arm stands and 10x lens available



HDMI Monitor sold separately

26700-400

"Dual-mode scope features HDMI and USB outputs"

Product ID	Description
26700-400	Cyclops Digital Microscope
26700-400-L10X	Cyclops Objective Lens 10X
26700-400-L4X	Cyclops Objective Lens 4X
26700-400-RC	Cyclops Remote Control
26700-400-STN	Cyclops Stand
26700-400-GN	Cyclops Gooseneck LED Lights

## Digital Microscope Stands



Product ID	Description
26700-210	Mighty Scope Boom Stand
26700-211	Mighty Scope Standard Stand
26700-212	Mighty Scope Flex Stand
26700-213	Mighty Scope Cradle Stand
26700-214	Mighty Scope Stand with Fine Adjustment
26700-215	Mighty Scope Dual View Stand
26700-311	Universal Digital Microscope Stand w/Backlight
26700-312	3D Stand for Digital Microscopes and Cameras
26700-312-LED	3D Stand with LED for Digital Microscopes and Cameras
26700-410-C18	Cyclops Articulating Arm Stand, Post Height 17-in
26700-411-C15	Cyclops Articulating Arm Stand, Post Height 12-in



26700-213

26700-214

26700-411-C15

26700-312-LED

26700-410-C18

26700-311

26700-215

# Stereo Zoom Microscopes

High-grade optics and unibody design



## SPZ-50 Series Stereo Zoom Microscopes

- ▶ Magnification Range: 6.7x to 50x (3.35x to 200x with optional lenses)
- ▶ Large 7.46:1 Zoom Ratio (best Zoom Ratio in this class)
- ▶ Field of View: 34.3mm to 3.6mm (1.35" to 0.14")
- ▶ Working Distance: 108mm (4.25")
- ▶ Includes high eye point DHW10x (F.N.23) eyepieces for comfortable viewing even for operators with eyeglasses
- ▶ Optional eyepieces available include DHW15x (F.N.15) & DHW20x (F.N.11.4)
- ▶ Trinocular body type features click stop zoom adjustment for extremely accurate measuring
- ▶ Trinocular port includes easy adjust C-mount camera adapter for fine focusing
- ▶ Includes rubber eyeguards and dust cover



SPZV-50

Product ID	Description
SPZ-50	SPZ-50 Stereo Zoom Binocular Microscope
SPZV-50	SPZV-50 Stereo Zoom Trinocular Microscope

## Optical Data for SPZ-50 & SPZV-50

Eyeiece   DHW10x (F.N.23)	w/0.5x		w/1.6x		w/2x
Auxiliary Lens	Nil	w/0.75x	w/1.6x	w/2x	
Magnifications	6.7x-50x	3.35x-25x	5x-37.5x	10.72x-80x	13.4x-100x
Working Dist.	108mm	240mm	132mm	50mm	41mm
Field of View	34.3-4.6mm	68.9-9.2mm	45.7-6.1mm	21.4-2.8mm	17.1-2.3mm

Eyeiece   DHW15x (F.N.15)	w/0.5x		w/1.6x		w/2x
Auxiliary Lens	Nil	w/0.75x	w/1.6x	w/2x	
Magnifications	10.05x-75x	5.02x-37.5x	7.53x-56.25x	16.08x-120x	20.1x-150x
Working Dist.	108mm	240mm	132mm	50mm	41mm
Field of View	22.3-3mm	44.7-6mm	29.8-4mm	16-1.8mm	11.1-1.5mm

Eyeiece   DHW20x (F.N.11.4)	w/0.5x		w/1.6x		w/2x
Auxiliary Lens	Nil	w/0.75x	w/1.6x	w/2x	
Magnifications	13.4x-100x	6.7x-50x	10.05x-75x	21.44x-160x	26.8x-200x
Working Dist.	108mm	240mm	132mm	50mm	41mm
Field of View	17-2.2mm	34-4.5mm	22.6-3mm	10.6-1.4mm	8.5-1.1mm

NOTE: When creating your own microscope system, the 0.5x Auxiliary Lens cannot be used on the SPZ series body with stands P, PF, T and TL.

Register online to receive updates on the newest products and for the latest specials from Aven.

## SPZH-135 Series Stereo Zoom Microscopes

- ▶ Magnification Range: 21x to 135x (14x to 180x with optional lenses)
- ▶ 6.4:1 Zoom Ratio
- ▶ Field of View: 34.3mm to 3.6mm (1.35" to 0.14")
- ▶ Working Distance: 84mm (3.3")
- ▶ Includes high eye point DHW15x (F.N.15) eyepieces for comfortable viewing even for operators with eyeglasses
- ▶ DHW20x (F.N.11.4) optional eyepieces available
- ▶ Trinocular body type features click stop zoom adjustment for extremely accurate measuring
- ▶ Trinocular port includes easy adjust C-mount camera adapter for fine focusing
- ▶ Includes rubber eyeguards and dust cover



SPZH-135

Product ID	Description
SPZH-135	SPZH-135 Stereo Zoom Binocular Microscope
SPZHT-135	SPZHT-135 Stereo Zoom Trinocular Microscope

## Optical Data for SPZH-135 & SPZHT-135

Eyeiece	DHW15x (F.N.15)		DHW20x (F.N.11.4)	
Auxiliary Lens	Nil	w/0.5x	Nil	w/0.5x
Magnifications	21x-135x	10.5x-67.5x	28x-180x	14x-90x
Working Dist.	84mm	135mm	84mm	135mm
Field of View	10.7-1.6mm	21.4-3.3mm	8.1-1.2mm	16.2-2.5mm

## NSW Series Binocular Stereo Microscopes

- ▶ Dual magnification (10x/20x; 10x/30x; 6x/20x)
- ▶ Field of view 38.3mm at 6x
- ▶ Field of view 23mm at 10x
- ▶ Field of view 11.5mm at 20x
- ▶ Field of view 7.6mm at 30x
- ▶ Includes DSW10x (F.N.23) eyepieces
- ▶ Includes rubber eyeguards and dust cover



NSW-620

Product ID	Description
NSW-20	Dual Magnification 10x & 20x Stereo Body
NSW-30	Dual Magnification 10x & 30x Stereo Body
NSW-620	Dual Magnification 6x & 20x Stereo Body

## Optical Data for NSW Series Binocular Stereo Microscopes

Models	NSW-20	NSW-30	NSW-620
Magnification (Field of View)	10x (23mm) 20x (11.5mm)	10x (23mm) 30x (7.6mm)	6x (38.3mm) 20x (11.5mm)
Objective Lenses	1x & 2x	1x & 3x	0.6x & 2x
Eyepieces	Wide Field DSW10x (F.N.23)		
Optical Body	360° rotatable binocular type 45° inclined eyepiece tube		
Working Distance	82.5mm	82.5mm	82.5mm



# Stereo Zoom Microscopes

High-grade optics and unibody design

## DSZ-44 Series Stereo Zoom Microscopes

- ▶ Magnification Range: 10x to 44x (2.5x to 140.8x with optional lenses)
- ▶ Zoom ratio: 4.4:1
- ▶ Field of view 23mm to 5.2mm (0.90" to 0.20")
- ▶ Working distance: 90mm (3.54")
- ▶ Includes Wide Field DSW10x (F.N.23) eyepieces
- ▶ Optional eyepieces available include DSW5x (F.N.22.5), DSW15x (F.N.15) & DSW20x (F.N.11.4)
- ▶ Trinocular port includes easy adjust C-mount camera adapter for fine focusing
- ▶ Includes rubber eyeguards and dust cover



DSZV-44

Product ID	Description
DSZ-44	DSZ-44 - Stereo Zoom Binocular Microscope
DSZV-44	DSZV-44 - Stereo Zoom Trinocular Microscope

### Optical Data for DSZ-44 & DSZV-44

Eyepiece   DSW5x (F.N. 22.5)				
Auxiliary Lens	Nil	w/0.5x	w/0.75x	w/1.6x
Magnifications	5x-22x	2.5x-11x	3.75x-16.5x	8x-35.2x
Working Dist.	90mm	150mm	105mm	45mm
Field of View	22.5-5.1mm	45-10.2mm	30.6-6.8mm	14-3.1mm

Eyepiece   DSW10x (F.N. 23)				
Auxiliary Lens	Nil	w/0.5x	w/0.75x	w/1.6x
Magnifications	10x-44x	5x-22x	7.5x-33x	16x-70.4x
Working Dist.	90mm	150mm	105mm	45mm
Field of View	23-5.2mm	46-10.4mm	30.6-6.9mm	14.3-3.2mm

Eyepiece   DSW15x (F.N. 15)				
Auxiliary Lens	Nil	w/0.5x	w/0.75x	w/1.6x
Magnifications	15x-66x	7.5x-33x	11.25x-49.5x	24x-105.6x
Working Dist.	90mm	150mm	105mm	45mm
Field of View	15-3.4mm	30-6.8mm	20-49.5mm	9.3-2.1mm

Eyepiece   DSW20x (F.N. 11.4)				
Auxiliary Lens	Nil	w/0.5x	w/0.75x	w/1.6x
Magnifications	20x-88x	10x-44x	15x-66x	32x-140.8x
Working Dist.	90mm	150mm	105mm	45mm
Field of View	11.4-2.5mm	22.8-5.1mm	15.2-3.45mm	7.1-1.6mm

## DSZ-70 Series Binocular Zoom Microscopes

- ▶ Magnification Range: 20x to 70x (5x to 224x with optional lenses)
- ▶ 3.5:1 Zoom Ratio
- ▶ Field of View: 10mm to 2.8mm (0.39" to 0.11")
- ▶ Working Distance: 80mm (4.25")
- ▶ Includes DSW10xZ (F.N.20) eyepieces
- ▶ Optional eyepieces available include DSW5xZ (F.N.20), DSW15x (F.N.15) & DSW20x (F.N.11.4)
- ▶ Versatile binocular microscope best suited for high magnification applications
- ▶ Includes rubber eyeguards and dust cover



DSZ-70

Product ID	Description
DSZ-70	DSZ-70 - Binocular Stereo Zoom Microscope

### Optical Data for DSZ-70

Eyepiece   DSW5xZ (F.N.20)				
Auxiliary Lens	Nil	w/0.5x	w/0.75x	w/1.6x
Magnifications	10x-35x	5x-17.5x	7.5x-26.25x	16x-56x
Working Dist.	80mm	120mm	85mm	41mm
Field of View	10-2.9mm	20-5.7mm	13.3-3.8mm	6.2-1.7mm

Eyepiece   DSW10xZ (F.N. 20)				
Auxiliary Lens	Nil	w/0.5x	w/0.75x	w/1.6x
Magnifications	20x-70x	10x-35x	15x-52.5x	32x-112x
Working Dist.	80mm	120mm	85mm	41mm
Field of View	10-2.8mm	20-5.7mm	13.3-3.8mm	6.2-1.7mm

Eyepiece   DSW15x (F.N. 15)				
Auxiliary Lens	Nil	w/0.5x	w/0.75x	w/1.6x
Magnifications	30x-105x	15x-52.5x	22.5x-78.75x	48x-168x
Working Dist.	80mm	120mm	85mm	41mm
Field of View	7.5-2.1mm	15-4.2mm	10-2.8mm	4.6-1.3mm

Eyepiece   DSW20x (F.N. 11.4)				
Auxiliary Lens	Nil	w/0.5x	w/0.75x	w/1.6x
Magnifications	40x-140x	20x-70x	30x-105x	64x-224x
Working Dist.	80mm	120mm	85mm	41mm
Field of View	5.7-1.6mm	11.4-3.2mm	7.6-2.1mm	3.5-1mm



### Design Your Own Microscope System

With a large variety of cameras, lighting options, and stands and focus mounts, you can create and order your own customized microscope system on our website. If you need help creating a custom system, please call our experienced sales team and let them assist you in creating a tailor made solution that will meet your specific requirements.



www.aveninc.com

# Stereo Zoom Microscopes

Preconfigured Microscope Systems



## SPZH-135 Stereo Zoom Binocular Microscope on Stand PLED

- ▶ Magnification Range: 21x to 135x
- ▶ Zoom Ratio: 6.4:1
- ▶ Field of View: 10.7-1.6mm (0.42" to 0.6")
- ▶ Working Distance: 84mm (3.3")
- ▶ Includes high eye point DHW15x (F.N.15) eyepieces for comfortable viewing even for operators with eyeglasses
- ▶ Diopter adjustment on both eyepiece tubes
- ▶ Adjustable Interpupillary Distance of 50mm to 74mm (1.96" to 2.91") accommodates any operator
- ▶ Pole stand with built in LED illumination with dimmer control
- ▶ Multi coated optical components, free from chromatic and spherical aberration
- ▶ Coarse and fine focusing, ideal for fine detail work



26800B-351

Product ID	Description
26800B-351	SPZH-135 Stereo Zoom Binocular Microscope on Stand PLED

## SPZH-135 Stereo Zoom Microscope with DBL Arm Boom, EARM, LED FOI illumination

- ▶ Magnification Range: 21x to 135x
- ▶ Zoom Ratio: 6.4:1
- ▶ Field of View: 10.7-1.6mm (0.42" to 0.6")
- ▶ Working Distance: 84mm (3.3")
- ▶ Includes high eye point DHW15x (F.N.15) eyepieces for comfortable viewing even for operators with eyeglasses
- ▶ Diopter adjustment on both eyepiece tubes
- ▶ Adjustable Interpupillary Distance of 50mm to 74mm (1.96" to 2.91") accommodates any operator
- ▶ Mounted in an E-ARM focus mount attached to a Double Arm Boom Stand that delivers the smooth movement of a ball bearing slide, letting the microscope glide easily over and across objects being viewed
- ▶ High Output LED fiber optic illuminator and ring light provide clear illumination for imaging
- ▶ Multi coated optical components, free from chromatic and spherical aberration
- ▶ Coarse and fine focusing, ideal for fine detail work



26800B-352

Product ID	Description
26800B-352	SPZH-135 Stereo Zoom Microscope w/ DBL Arm Boom, EARM, LED FOI

Register online to receive updates on the newest products and for the latest specials from Aven.

## SPZHT-135 Stereo Zoom Trinocular Microscope on Stand PLED with HD Monitor

- ▶ Magnification Range: 21x to 135x
- ▶ On screen Magnification Range: 27x to 179x
- ▶ Zoom Ratio: 6.4:1
- ▶ Field of View: 10.7-1.6mm (0.42" to 0.6")
- ▶ Working Distance: 84mm (3.3")
- ▶ Includes high eye point DHW15x (F.N.15) eyepieces for comfortable viewing even for operators with eyeglasses
- ▶ Diopter adjustment on both eyepiece tubes
- ▶ Adjustable Interpupillary Distance of 50mm to 74mm (1.96" to 2.91") accommodates any operator
- ▶ Click stop zoom adjustments for accurate, repeatable measurement
- ▶ 1080P HD camera for unsurpassed imagery
- ▶ One touch fine focus trinocular camera port adjustment for quick, easy camera focus and parfocaling the scope
- ▶ Pole stand with built in LED illumination with dimmer control
- ▶ Multi coated optical components, free from chromatic and spherical aberration
- ▶ Coarse and fine focusing, ideal for fine detail work
- ▶ Monitor helps increase productivity by reducing eye & neck strain



26800B-353

Product ID	Description
26800B-353	SPZHT-135 Stereo Zoom Trinocular Microscope on Stand PLED with HD Monitor

## SPZHT-135 Stereo Zoom Trinocular Microscope on Stand LW w/ FOI

- ▶ Magnification Range: 21x to 135x
- ▶ On screen Magnification Range: 76x to 494x
- ▶ Zoom Ratio: 6.4:1
- ▶ Field of View: 10.7-1.6mm (0.42" to 0.6")
- ▶ Working Distance: 84mm (3.3")
- ▶ Includes high eye point DHW15x (F.N.15) eyepieces for comfortable viewing even for operators with eyeglasses
- ▶ Diopter adjustment on both eyepiece tubes
- ▶ Adjustable Interpupillary Distance of 50mm to 74mm (1.96" to 2.91") accommodates any operator
- ▶ Click stop zoom adjustments for accurate, repeatable measurement
- ▶ 1080P HD camera for unsurpassed imagery
- ▶ One touch fine focus trinocular camera port adjustment for quick, easy camera focus and parfocaling the scope
- ▶ Mounted in an E-ARM focus mount attached to a LW articulating arm stand that extends area of view and working distance
- ▶ High Output LED fiber optic illuminator and ring light provide clear illumination for imaging
- ▶ Multi coated optical components, free from chromatic and spherical aberration
- ▶ Coarse and fine focusing, ideal for fine detail work
- ▶ Monitor helps increase productivity by reducing eye & neck strain



26800B-354

Product ID	Description
26800B-354	SPZHT-135 Stereo Zoom Trinocular Microscope on Stand LW with LED Fiber Optic Illuminator





# Stereo Zoom Microscopes

Preconfigured Microscope Systems

## SPZ-50 Stereo Zoom Binocular Microscope on Stand DABS w/ Integrated LED Ring Light

- ▶ Magnification Range: 6.7x to 50x
- ▶ Large Zoom Ratio: 7.46:1
- ▶ Field of View: 34.3mm to 4.6mm (1.35" to 0.18")
- ▶ Working Distance: 108mm (4.25")
- ▶ Includes high eye point DHW10x (F.N.23) eyepieces for comfortable viewing even for operators with eyeglasses
- ▶ Diopter adjustment on both eyepiece tubes
- ▶ Adjustable Interpupillary Distance of 52mm to 75mm (2.04" to 2.95") accommodates any operator
- ▶ Double Arm Boom Stand delivers smooth movement of a ball bearing slide, letting the microscope glide easily over and across objects being viewed
- ▶ Tilttable arbor enables you to angle the microscope for maximum comfort and viewing
- ▶ Integrated 60 LED Ring Light with dimmer
- ▶ Multi coated optical components, free from chromatic and spherical aberration
- ▶ Coarse and fine focusing, ideal for fine detail work



26800B-369

Product ID	Description
26800B-369	SPZ-50 Stereo Zoom Binocular Microscope on Stand DABS & Integrated LED Ring Light

## SPZ-50 Stereo Zoom Binocular Microscope on Stand DABS with LED FOI

- ▶ Magnification Range: 6.7x to 50x
- ▶ Large Zoom Ratio: 7.46:1
- ▶ Field of View: 34.3mm to 4.6mm (1.35" to 0.18")
- ▶ Working Distance: 108mm (4.25")
- ▶ Includes high eye point DHW10x (F.N.23) eyepieces for comfortable viewing even for operators with eyeglasses
- ▶ Diopter adjustment on both eyepiece tubes
- ▶ Adjustable Interpupillary Distance of 52mm to 75mm (2.04" to 2.95") accommodates any operator
- ▶ Double Arm Boom Stand delivers smooth movement of a ball bearing slide, letting the microscope glide easily over and across objects being viewed
- ▶ Tilt able arbor enables you to angle the microscope for maximum comfort and viewing
- ▶ High Output LED fiber optic illuminator and ring light provide clear illumination for imaging
- ▶ Multi coated optical components, free from chromatic and spherical aberration
- ▶ Coarse and fine focusing, ideal for fine detail work



26800B-370

Product ID	Description
26800B-370	SPZ-50 Stereo Zoom Binocular Microscope on Stand DABS w/ LED FOI



## SPZ-50 Stereo Zoom Binocular Microscope on Stand PLED

- ▶ Magnification Range: 6.7x to 50x
- ▶ Large Zoom Ratio: 7.46:1
- ▶ Field of View: 34.3mm to 4.6mm (1.35" to 0.18")
- ▶ Working Distance: 108mm (4.25")
- ▶ Includes high eye point DHW10x (F.N.23) eyepieces for comfortable viewing even for operators with eyeglasses
- ▶ Diopter adjustment on both eyepiece tubes
- ▶ Adjustable Interpupillary Distance of 52mm to 75mm (2.04" to 2.95") accommodates any operator
- ▶ Pole stand with built in LED illumination with dimmer control
- ▶ Multi coated optical components, free from chromatic and spherical aberration
- ▶ Coarse and fine focusing, ideal for fine detail work



26800B-371

Product ID	Description
26800B-371	SPZ-50 Stereo Zoom Binocular Microscope on Stand DABS & Integrated LED Ring Light

## SPZ-50 Stereo Zoom Binocular Microscope on Stand LW & LED Ring Light

- ▶ Magnification Range: 6.7x to 50x
- ▶ Large Zoom Ratio: 7.46:1
- ▶ Field of View: 34.3mm to 4.6mm (1.35" to 0.18")
- ▶ Working Distance: 108mm (4.25")
- ▶ Includes high eye point DHW10x (F.N.23) eyepieces for comfortable viewing even for operators with eyeglasses
- ▶ Diopter adjustment on both eyepiece tubes
- ▶ Adjustable Interpupillary Distance of 52mm to 75mm (2.04" to 2.95") accommodates any operator
- ▶ Mounted in an E-ARM focus mount attached to a LW articulating arm stand that extends area of view and working distance
- ▶ 60 LED Ring Light with brightness and 4 sector control
- ▶ Multi coated optical components, free from chromatic and spherical aberration
- ▶ Coarse and fine focusing, ideal for fine detail work



26800B-372

Product ID	Description
26800B-372	SPZ-50 Stereo Zoom Binocular Microscope on Stand LW & LED Ring Light

## SPZ-50 Stereo Zoom Microscope on Stand P with Diffuse Axial LED Illuminator

- ▶ Magnification Range: 6.7x to 50x
- ▶ Large Zoom Ratio: 7.46:1
- ▶ Field of View: 34.3mm to 4.6mm (1.35" to 0.18")
- ▶ Working Distance: 108mm (4.25")
- ▶ Includes high eye point DHW10x (F.N.23) eyepieces for comfortable viewing even operators with eyeglasses
- ▶ Diopter adjustment on both eyepiece tubes
- ▶ Adjustable Interpupillary Distance of 52mm to 75mm (2.04" to 2.95") accommodates any operator
- ▶ Compact lightweight pole stand with focus mount
- ▶ Diffuse Axial LED Illuminator, ideal for viewing highly reflective parts, eliminates hot spots & reduces glare
- ▶ Multi coated optical components, free from chromatic and spherical aberration
- ▶ Coarse and fine focusing, ideal for fine detail work



26800B-384

Product ID	Description
26800B-384	SPZ-50 Stereo Zoom Binocular Microscope on Stand P w/ Diffuse Axial Illuminator

# Stereo Zoom Microscopes

Preconfigured Microscope Systems

## DSZ-44 Stereo Zoom Binocular Microscope on Stand DABS with LED FOI

- ▶ Magnification Range: 10x to 44x
- ▶ Zoom Ratio: 4.4:1
- ▶ Field of View: 23-5.2mm (0.91" to 0.2")
- ▶ Working Distance: 90mm (3.54")
- ▶ Includes wide field DSW10x (F.N.23) eyepieces
- ▶ Diopter adjustment on both eyepiece tubes
- ▶ Adjustable Interpupillary Distance of 52mm to 75mm (2.04" to 2.95") accommodates any operator
- ▶ Double Arm Boom Stand delivers smooth movement of a ball bearing slide, letting the microscope glide easily over and across objects being viewed
- ▶ Tilttable arbor enables you to angle the microscope for maximum comfort and viewing
- ▶ High Output LED fiber optic illuminator and ring light provide clear illumination for imaging
- ▶ Multi coated optical components, free from chromatic and spherical aberration
- ▶ Coarse and fine focusing, ideal for fine detail work



26800B-303

Product ID	Description
26800B-303	DSZ-44 Stereo Zoom Binocular Microscope on Stand DABS with LED Fiber Optic Illuminator

## DSZ-44 Stereo Zoom Binocular Microscope on Stand LW with LED Ring Light

- ▶ Magnification Range: 10x to 44x
- ▶ Zoom Ratio: 4.4:1
- ▶ Field of View: 23-5.2mm (0.91"-0.2")
- ▶ Working Distance: 90mm (3.54")
- ▶ Includes wide field DSW10x (F.N.23) eyepieces
- ▶ Diopter adjustment on both eyepiece tubes
- ▶ Adjustable Interpupillary Distance of 52mm to 75mm (2.04" to 2.95") accommodates any operator
- ▶ Mounted in an E-ARM focus mount attached to a LW articulating arm stand that extends area of view and working distance
- ▶ 60 LED Ring Light with brightness and 4 sector control
- ▶ Multi coated optical components, free from chromatic and spherical aberration
- ▶ Coarse and fine focusing, ideal for fine detail work



26800B-308

Product ID	Description
26800B-308	DSZ-44 Stereo Zoom Binocular Microscope on Stand LW with LED Ring Light

See Aven's exclusive article "How to Select the Right Microscope or Video Inspection System"



www.aveninc.com



## DSZ-44 Gemscope

- ▶ Magnification Range: 10x to 44x
- ▶ Zoom Ratio: 4.4:1
- ▶ Field of View: 23-5.2mm (0.91"-0.2")
- ▶ Working Distance: 90mm (3.54")
- ▶ Includes wide field DSW10x (F.N.23) eyepieces
- ▶ Diopter adjustment on both eyepiece tubes
- ▶ Adjustable Interpupillary Distance of 52mm to 75mm (2.04" to 2.95") accommodates any operator
- ▶ Gemology stand (inclines from 0-10°) with independently controllable fluorescent front light and dimmable halogen pipe light with separate controls
- ▶ Multi coated optical components, free from chromatic and spherical aberration
- ▶ Coarse and fine focusing, ideal for fine detail work



26800B-386

Product ID	Description
26800B-386	DSZ-44 Gemscope

## DSZV-44 Gemscope w/1080P HD Camera

- ▶ Magnification Range: 10x to 44x
- ▶ Zoom Ratio: 4.4:1
- ▶ Field of View: 23-5.2mm (0.91"-0.2")
- ▶ Working Distance: 90mm (3.54")
- ▶ Includes wide field DSW10x (F.N.23) eyepieces
- ▶ Diopter adjustment on both eyepiece tubes
- ▶ Adjustable Interpupillary Distance of 52mm to 75mm (2.04" to 2.95") accommodates any operator
- ▶ 1080P HD camera for unsurpassed imagery
- ▶ Gemology stand (inclines from 0-10°) with independently controllable fluorescent front light and dimmable halogen pipe light with separate controls
- ▶ Multi coated optical components, free from chromatic and spherical aberration
- ▶ Coarse and fine focusing, ideal for fine detail work
- ▶ Monitor helps increase productivity by reducing eye & neck strain



26800B-387

to 75mm (2.04")

Product ID	Description
26800B-387	DSZV-44 Gemscope w/1080P HD Camera

## DSZV-44 Stereo Zoom Trinocular Microscope on Stand PLED with Mighty Cam USB 5M CMOS Camera

- ▶ Magnification Range: 10x to 44x
- ▶ Zoom Ratio: 4.4:1
- ▶ Field of View: 23-5.2mm (0.91"-0.2")
- ▶ Working Distance: 90mm (3.54")
- ▶ Includes wide field DSW10x (F.N.23) eyepieces
- ▶ Diopter adjustment on both eyepiece tubes
- ▶ Adjustable Interpupillary Distance of 52mm to 75mm (2.04" to 2.95") accommodates any operator
- ▶ Mighty Cam USB 5M CMOS Camera with ezMeasure software
- ▶ Pole stand with built in LED illumination with dimmer control
- ▶ Multi coated optical components, free from chromatic and spherical aberration
- ▶ Coarse and fine focusing, ideal for fine detail work



26800B-323

Product ID	Description
26800B-323	DSZV-44 Stereo Zoom Trinocular Microscope on Stand PLED with Mighty Cam USB 5M CMOS Camera



# Stereo Zoom Microscopes

Preconfigured Microscope Systems

## DSZV-44 Stereo Zoom Trinocular Microscope on Stand PLED HD Camera and 8" HD Monitor

- ▶ Magnification Range: 10x to 44x
- ▶ Zoom Ratio: 4.4:1
- ▶ Field of View: 23-5.2mm (0.91"-0.2")
- ▶ Working Distance: 90mm (3.54")
- ▶ Includes wide field DSW10x (F.N.23) eyepieces
- ▶ Diopter adjustment on both eyepiece tubes
- ▶ Adjustable Interpupillary Distance of 52mm to 75mm (2.04" to 2.95") accommodates any operator
- ▶ 1080P HD camera for unsurpassed imagery
- ▶ Pole stand with built in LED illumination with dimmer control
- ▶ Multi coated optical components, free from chromatic and spherical aberration
- ▶ Coarse and fine focusing, ideal for fine detail work



26800B-327

Product ID	Description
26800B-327	DSZV-44 Stereo Zoom Trinocular Microscope on Stand PLED HD Camera and 8" HD Monitor

## DSZ-70 Stereo Zoom Binocular Microscope on Stand P with LED FOI

- ▶ Magnification Range: 20x to 70x
- ▶ Zoom Ratio: 3.5:1
- ▶ Field of View: 10-2.8mm (0.39"-0.11")
- ▶ Working Distance: 80mm (3.15")
- ▶ Includes wide field DSW10xZ (F.N.20) eyepieces
- ▶ Diopter adjustment on both eyepiece tubes
- ▶ Adjustable Interpupillary Distance of 52mm to 75mm (2.04" to 2.95") accommodates operator
- ▶ Compact lightweight pole stand with focus mount
- ▶ High Output LED fiber optic illuminator and ring light provide clear illumination for imaging
- ▶ Multi coated optical components, free from chromatic and spherical aberration
- ▶ Coarse and fine focusing, ideal for fine detail work



26800B-344

any

Product ID	Description
26800B-344	DSZ-70 Stereo Zoom Binocular Microscope on Stand P with LED Fiber Optic Illuminator

## NSW-20 Stereo Binocular Microscope with Stand PLED

- ▶ Magnification: 10x & 20x
- ▶ Field of View 10x; 23mm (0.91")
- ▶ Field of View 20x; 11.5mm (0.45")
- ▶ Working Distance: 113mm (4.45")
- ▶ Includes wide field DSW10x (F.N.23) eyepieces
- ▶ Diopter adjustment on both eyepiece tubes
- ▶ Adjustable Interpupillary Distance of 52mm to 75mm (2.04" to 2.95") accommodates any operator
- ▶ Pole stand with built in LED illumination with dimmer control
- ▶ Multi coated optical components, free from chromatic and spherical aberration
- ▶ Coarse and fine focusing, ideal for fine detail work



26800B-360

Product ID	Description
26800B-360	NSW-20 Stereo Binocular Microscope with Stand PLED

## NSW-30 Stereo Binocular Microscope with LW Stand & LED Ring Light



26800B-361

- ▶ Magnification: 10x & 30x
- ▶ Field of View 10x; 23mm (0.91")
- ▶ Field of View 30x; 7.6mm (0.30")
- ▶ Working Distance: 107mm (4.21")
- ▶ Includes wide field DSW10x (F.N.23) eyepieces
- ▶ Diopter adjustment on both eyepiece tubes
- ▶ Adjustable Interpupillary Distance of 52mm to 75mm (2.04" to 2.95") accommodates any operator
- ▶ Mounted in an E-ARM focus mount attached to a LW articulating arm stand that extends area of view and working distance
- ▶ 60 LED Ring Light with brightness and 4 sector control
- ▶ Multi coated optical components, free from chromatic and spherical aberration
- ▶ Coarse and fine focusing, ideal for fine detail work

Product ID	Description
26800B-361	NSW-30 Stereo Binocular Microscope with LW Stand & LED Ring Light

## NSW-620 Stereo Binocular Microscope with Stand PLED

- ▶ Magnification: 6x & 20x
- ▶ Field of View 6x; 38.3mm (1.51")
- ▶ Field of View 20x; 11.5mm (0.45")
- ▶ Working Distance: 82.5mm (3.24")
- ▶ Includes wide field DSW10x (F.N.23) eyepieces
- ▶ Diopter adjustment on both eyepiece tubes
- ▶ Adjustable Interpupillary Distance of 52mm to 75mm (2.04" to 2.95") accommodates any operator
- ▶ Pole stand with built in LED illumination with dimmer control
- ▶ Multi coated optical components, free from chromatic and spherical aberration
- ▶ Coarse and fine focusing, ideal for fine detail work



26800B-365

Product ID	Description
26800B-365	NSW-620 Stereo Binocular Microscope with Stand PLED



# Video Inspection Systems

Video Inspection System Lenses



## Micro Lens System Zoom 640

- ▶ Infinity Optical Design for large depth of field and zoom ratio
- ▶ Parfocal throughout zoom range
- ▶ Compact design
- ▶ High contrast images and vivid colors



26700-151

Aven Micro Lens System produces crisp and clear images that are distortion free and void of chromatic aberration. This lens system comes with detents which allows you to calibrate the lens for measurement repeatability. Comes standard with 1x C mount coupler and 1x objective lens. Total magnification is 0.6x to 4.0x, Field of View is 6 x 8mm at low magnification and 0.8 x 1.2mm at high magnification. Working Distance is 82mm. Additional couplers and objective lenses are available to help you configure a lens system to meet your application.

Product ID	Description
26700-151	Micro Lens System Zoom 640

## Micro Lens System Zoom 640 with In Line LED Coaxial Illumination

- ▶ Inline Coaxial Illumination for highly reflective surfaces
- ▶ Infinity Optical Design for large depth of field and zoom ratio
- ▶ Parfocal throughout zoom range
- ▶ Compact design
- ▶ High contrast images and vivid colors



26700-151-CX

Aven Micro Lens System with inline Coaxial Illumination is ideal for applications involving highly reflective surfaces, such as wafers, polished parts and fluids. This lens system will provide even illumination in high magnification applications. This lens system comes with detents which allows you to calibrate the lens for measurement repeatability. Comes standard with 1x C-mount coupler and 1x objective lens and LED illuminator with intensity control. Total magnification is 0.6x to 4.0x, Field of view is 6 x 8mm at low magnification and 0.8 x 1.2mm at high magnification. Working distance is 82mm. Additional couplers and objective lenses are available to help you configure a lens system to meet your application.

Product ID	Description
26700-151-CX	Micro Lens System Zoom 640 with In Line LED Coaxial Illumination

## Micro Lens System FM123

- ▶ Four Lenses
- ▶ Switchable Magnification
- ▶ Object stays in focus when switching magnification
- ▶ Can be used as a monocular microscope with included 10x eyepiece
- ▶ C-Mount Adapter Included

The Micro FM123 lens has four switchable lenses, 0.78x, 1.56x, 2.34x and 3.12x, located in the unit. Simply rotate the head to switch between magnifications. It includes a 10x eyepiece which allows you to use the lens as a monocular microscope with magnification of 7.8x, 15.6x, 23.4x and 31.2x. Using a 1/3" CCD camera and a 19" monitor, the on screen magnification is about 62x, 125x, 188x and 250x subject to 4:3 aspect ratio of both screen and camera chip. For other aspect ratio such as 16:9, these magnifications may change depending on the screen and the camera used. Ideal for high magnification field of view measurement.



26700-

Product ID	Description
26700-151	Micro Lens System FM123

## Macro Lens System Zoom 7000

- ▶ 6:1 zoom ratio
- ▶ 6x magnification over focal range of 18mm to 108mm (0.71" to 4.25")
- ▶ Working distance 127mm (5") to Infinity
- ▶ Compatible with cameras 16.9mm (0.67") or smaller

The Zoom 7000 is a close focusing macro video lens ideal for applications where objects over 25mm (1") in diameter must be imaged. It offers unsurpassed clarity and parfocal zoom capabilities. Compatible with cameras 2/3" (16.9mm) or smaller. Ideal for quality assurance or assembly applications where easy to view, sharp and true to life magnified image of your product is required.



26700-180

Product ID	Description
26700-180	Macro Lens System Zoom 7000

## Create Your Own Custom Video Inspection System

With a large variety of adapters, auxiliary lenses, cameras, lighting options, video capture cards and stands you can create and order your own customized video inspection system on our website. If you need help creating a custom video inspection system, please call our experienced sales team and let them assist you in creating a tailor made solution that will meet your specific requirements. Whether you are inspecting objects like integrated circuits, solder joints and small parts, or you require magnification for precision assembly we can provide a customized solution to fit your needs.



www.aveninc.com



# Video Inspection Systems

Adapters, Couplers and Objective Lenses

## Adapter Plate for Macro Lens Zoom 7000

- ▶ Adaptor for Macro Lens Zoom 7000
- ▶ For focus mounts (26800B-517 & 26800B-518)
- ▶ Outside diameter: 73mm
- ▶ Inside diameter: 46.75mm
- ▶ 22.5mm height



26800B-430

Product ID	Description
26800B-430	Adapter Plate for Macro Lens Zoom 7000

## Adapter Plate for Micro Lens 640

- ▶ Adaptor for Micro Lens 640
- ▶ For focus mounts (26800B-517 & 26800B-518)
- ▶ Outside diameter: 73mm
- ▶ Inside diameter: 35.25mm
- ▶ 24mm height



26700-151AP

Product ID	Description
26700-151AP	Adapter Plate for Micro Lens 640

## C-Mount Coupler 0.5x

- ▶ Mounts to Micro Video Lens System Zoom 640
- ▶ Reduces magnification by 0.5x
- ▶ Ideal for cameras with sensors 12.7mm (1/2") or larger
- ▶ Can be used with any C-Mount camera
- ▶ See optical specification chart for more details



26700-156

Product ID	Description
26700-156	C-Mount Coupler 0.5x

## C-Mount Coupler 1.0x

- ▶ Mounts to Micro Video Lens System Zoom 640
- ▶ Increases magnification by 1x
- ▶ Ideal for with sensors less than 16.9mm (2/3")
- ▶ Can be used with any C-Mount camera
- ▶ See optical specification chart for more details



26700-158

Product ID	Description
26700-158	C-Mount Coupler 1.0x

## Objective Lens 0.5x

- ▶ Objective Lens for Micro Video Lens System Zoom 640
- ▶ Reduces magnification by 0.5x
- ▶ Color corrected lens system
- ▶ Working distance 175mm (6.9")
- ▶ See optical specification chart for more details



26700-162

Product ID	Description
26700-162	Objective Lens 0.5x

## Objective Lens 0.75x

- ▶ Objective Lens for Micro Video Lens System Zoom 640
- ▶ Reduces magnification by 0.75x
- ▶ Color corrected lens system
- ▶ Working distance 117mm (4.6")
- ▶ See optical specification chart for more details



26700-163

Product ID	Description
26700-163	Objective Lens 0.75x

## Objective Lens 1x

- ▶ Objective Lens for Micro Video Lens System Zoom 640
- ▶ Color corrected lens system
- ▶ Working distance 82mm (3.2")
- ▶ See optical specification chart for more details



26700-164

Product ID	Description
26700-164	Objective Lens 1x

## Objective Lens 1.5x

- ▶ Objective Lens for Micro Video Lens System Zoom 640
- ▶ Increases magnification by 1.5x
- ▶ Color corrected lens system
- ▶ Working distance 54mm (2.1")
- ▶ See optical specification chart for more details



26700-165

Product ID	Description
26700-165	Objective Lens 1.5x

## Objective Lens 2x

- ▶ Objective Lens for Micro Video Lens System Zoom 640
- ▶ Increases magnification by 2x
- ▶ Color corrected lens system
- ▶ Working distance 35mm (1.4")
- ▶ See optical specification chart for more details



26700-166

Product ID	Description
26700-166	Objective Lens 2x

## Optical Data Chart

Objective		CCD Coupler		
Magnification	Working Distance		0.5X	1X
0.3X	WD:293mm	Total Mag.	0.09X-0.6X	0.18X-1.2X
		FOV(mm)	40X53.33-6X8	20X26.67-3X4
0.5X	WD:175mm	Total Mag.	0.15X-1X	0.3X-2X
		FOV(mm)	24X32-3.6X4.8	12X16-1.8X2.4
0.75X	WD:117mm	Total Mag.	0.225X-1.5X	0.45X-3X
		FOV(mm)	16X21.33-2.4X3.2	8X10.67-1.2X1.6
1X	WD: 82mm	Total Mag.	0.3X-2X	0.6X-4X
		FOV(mm)	12X16-1.8X2.4	6X8-0.9X1.2
1.5X	WD:54mm	Total Mag.	0.45X-3X	.9X-6X
		FOV(mm)	8X10.67-1.2X1.6	4X5.33-0.6X0.8
2X	WD:35mm	Total Mag.	0.6X-4X	1.2X-8X
		FOV(mm)	6X8-0.9X1.2	3X4-0.45X0.6

# Video Inspection Systems

Preconfigured Micro Zoom Video Inspection Systems



## Micro Zoom Series 640 PK1

- ▶ PC not required for image processing
- ▶ Produces crisp clear images
- ▶ White LED illumination with intensity control
- ▶ Color camera with movable and switchable crosshairs
- ▶ On screen menu for controlling color, contrast, white balance etc.



26700-102-00

- ▶ Heavy Duty Post Stand includes 10 tapped holes for mounting x-y stages
- ▶ Compact system, helps save bench space
- ▶ On screen magnification: 14.25x to 190x
- ▶ Working distance: 82mm with 1x Objective Lens
- ▶ Field of view: 6 x 8 to 0.9 x 1.2mm with 1x Objective
- ▶ Parfocal lens system

Product ID	Description
26700-102-00	Micro Zoom Series 640 PK1

## Micro Zoom Series 640 PK2

- ▶ PC not required for image processing
- ▶ Produces stunning clear and crisp HD images
- ▶ White LED Fiber Optic Illumination provides shadow free illumination
- ▶ 1080P Color Camera with HDMI output; On screen menu for controlling color, contrast, white balance etc
- ▶ Dual Arm Boom Stand provides stability and eliminates vibrations while allowing you to move over large areas of the object being viewed
- ▶ Lens can be angled in any direction for enhanced viewing
- ▶ On screen magnification: 19.5x to 263x
- ▶ Working distance: 82mm with 1x Objective Lens
- ▶ Field of view: 6 x 8 to 0.9 x 1.2mm with 1x Objective
- ▶ Parfocal lens system



26700-102-10

Product ID	Description
26700-102-10	Micro Zoom Series 640 PK2

## Micro Zoom Series 640 PK3 Benchtop Measurement System

- ▶ PC not required for image processing
- ▶ Produces crisp clear images, PC not required for image processing
- ▶ White LED Fiber Optic Illumination
- ▶ HD 1080p Color camera with USB mouse control and Built in Measurement Software
- ▶ Measure lines/distance, circles, arcs, squares, polygon, perimeters, angles, center to center distance
- ▶ Compact system, helps save bench space
- ▶ On screen magnification: 19.5x to 263x
- ▶ Working distance: 82mm with 1x Objective Lens
- ▶ Field of view: 6 x 8 to 0.9 x 1.2mm with 1x Objective
- ▶ Parfocal lens system

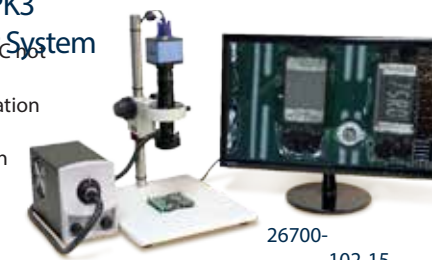

26700-102-15

Product ID	Description
26700-102-15	Micro Zoom Series 640 PK3 Benchtop Measurement System

## Micro Series FM123 PK4 Benchtop Measurement System

- ▶ Measure lines/distance, circles, arcs, and polygons
- ▶ Produces crisp and clear images
- ▶ White LED Fiber Optic Illumination
- ▶ Color camera with USB mouse control and Built in Measurement Software
- ▶ On screen menu for controlling color, contrast, white balance etc
- ▶ On screen magnification from 44.2x to 176.9x
- ▶ Working distance: 64.3mm
- ▶ Four switchable lens system: 0.78x, 1.56x, 2.34x, and 3.12x
- ▶ Field of view: 6 x 4.5mm @ 0.78x; 3 x 2.2mm @ 1.56x; 2 x 1.5mm @ 2.34x; 1.5 x 1.1mm @ 3.12x



26700-102-20

Product ID	Description
26700-102-20	Micro Series FM123 PK4 Benchtop Measurement System

## Micro Zoom Series 745 PK1

- ▶ Produces crisp clear images
- ▶ View object on a large 22" HD Color LED Monitor
- ▶ Working distance: 46mm
- ▶ Field of view: 8.8 to 1.3mm
- ▶ On screen magnification from 50x to 340x
- ▶ Compact system helps save bench space
- ▶ White top and bottom LED illumination with intensity control
- ▶ 720p VGA color camera with cross hair and on screen menu for controlling color, contrast, white balance etc.



26700-102-30

Product ID	Description
26700-102-30	Micro Zoom Series 745 PK1

## Micro Zoom Series 640 with Coaxial Illumination PK 5

- ▶ In line coaxial illumination helps reduce when inspecting shiny parts
- ▶ Color HD camera with movable and switchable crosshairs
- ▶ On screen menu for controlling color, contrast and white balance
- ▶ Parfocal lens system
- ▶ Working distance: 46mm
- ▶ Field of view: 8.8 to 1.3mm
- ▶ On screen magnification from 50x to 340x



26700-102-35

Product ID	Description
26700-102-35	Micro Zoom Series 640 with Coaxial Illumination PK 5



# Video Inspection Systems

Preconfigured Macro Zoom Video Inspection Systems

## Macro Series Zoom 7000 PK M1

- ▶ Stunning Life Like Picture on 22" HD LCD Monitor
- ▶ Large Magnification Range 3.7x to 61.9x
- ▶ Large working distance; 117.8 to 304.8mm
- ▶ 6:1 zoom allows for quick magnification of area of interest
- ▶ Parfocal over entire zoom range
- ▶ PC not required for image processing
- ▶ Heavy Duty Post Stand includes 10 tapped holes for mounting x-y stages



26700-103-00

Product ID	Description
26700-103-00	Macro Series Zoom 7000 PK M1

## Macro View All in One Scope

- ▶ Wide field of view and long working distance
- ▶ Two parfocal lenses (10x & 15x)
- ▶ Built in 60 LED ring light with intensity control
- ▶ 2x Digital Zoom and Mirror function built into camera
- ▶ Compact and Easy to Use
- ▶ Focus mount includes course and fine adjustment knobs
- ▶ On screen Magnification: 10x and 15x; 20x and 30x with optional 2x lens; 40x and 60x with optional 4x lens
- ▶ Working distance: 145mm; 69mm with optional 2x lens; 29mm with optional 4x lens
- ▶ Field of view: 20 x 15mm at 10x; 13.3 x 10mm at 15x



26700-104-00

Product ID	Description
26700-104-00	Macro View All in One Scope

## Auxiliary Lens 2x for Macro All in One Scope

- ▶ Increases on screen magnification for Macro View All in One Scope
- ▶ Decreases working distance and field of view



26700-104-2X

Product ID	Description
26700-104-2x	Auxiliary Lens 2x for Macro View All in One Scope

## Auxiliary Lens 4x for Macro All in One Scope

- ▶ Increases on screen magnification for Macro View All in One Scope
- ▶ Decreases working distance and field of view



26700-104-4X

Product ID	Description
26700-104-4x	Auxiliary Lens 4x for Macro View All in One Scope

## Macro Series Zoom 7000 PK M2

- ▶ Stunning Life Like Picture on 22" HD LCD Monitor
- ▶ Large Magnification Range 3.7x to 61.9x
- ▶ Large working distance; 117.8 to 304.8mm
- ▶ Double Arm "Easy Glide" Boom Stand with heavy base for stability
- ▶ Parfocal over entire zoom range
- ▶ PC not required for image processing
- ▶ 6:1 zoom allows for quick magnification of area of interest



26700-103-10

Product ID	Description
26700-103-10	Macro Series Zoom 7000 PK M2

## Macro Series Zoom 7000 PK M3

- ▶ Stunning Life Like Picture on 22" HD LCD Monitor
- ▶ Large Magnification Range 3.7x to 61.9x
- ▶ Large working distance; 117.8 to 304.8mm
- ▶ 6:1 zoom allows quick magnification of area of interest
- ▶ Light weight articulating arm with E-Arm allows users to cover a large working area and move microscope out of the way when not in use
- ▶ Parfocal over entire zoom range
- ▶ PC not required for image processing



26700-103-20

Product ID	Description
26700-103-20	Macro Series Zoom 7000 PK M3

# Microscope & Video Accessories

CCD & CMOS Cameras

## Mighty Cam USB 5M CMOS Camera

The Mighty Cam USB 5M CMOS camera includes ezMeasure software which produces stunning images with exceptional clarity for measuring, analyzing and annotating your magnified images. The large 5M CMOS sensor provides excellent color fidelity offering true color out of the box with no need for adjustment. The versatile C/CS lense mount adapter ring attaches between camera and lens, and converts a CS-Mount lens to C-Mount camera to achieve a focused image.



26100-243

- ▶ Provides wide, dynamic range and crisp, natural color reproduction in any lighting
- ▶ USB 5M CMOS Camera with ezMeasure Software
- ▶ 5M CMOS Sensor (2592 x 1944)
- ▶ Easy Plug and Play USB 2.0 Interface
- ▶ Compact and Light Weight
- ▶ Versatile C/CS lenses mount
- ▶ Ideal for inspection, scientific image analysis, biomedical research

Product ID	Description
26100-243	Mighty Cam USB 5M CMOS Camera

## Mighty Cam Connect

The Mighty Cam Connect is a new generation microscope camera, turning traditional microscopes into wireless inspection systems. The Mighty Cam Connect features a built-in Wi-Fi hotspot that wirelessly broadcasts high quality images in real time to a free app available for iOS and Android devices.



26100-256

- ▶ Live streaming, capture and record video from the Free Wi-Viewer app
- ▶ Hardware snapshot button for instantly saving image to all connected devices
- ▶ Wi-Fi signal broadcasts up to 10m
- ▶ Connect up to 3 iOS/Android devices, share real time image simultaneously
- ▶ Active pixel technology for sharp images and accurate color reproduction

Product ID	Description
26100-256	Mighty Cam Connect

## Mighty Cam VGA Color Camera 720p

Aven's color VGA camera allows connectivity directly to a PC monitor. A PC is not required for image processing thus saving you the cost of a PC and bench space. All features of the digital camera can be controlled via on screen menus such as RGB values, white balance, cross hair, auto exposure, etc.



26100-252

- ▶ Compact 720p Color Camera with VGA output
- ▶ Live/Freeze Image Function; Cross Hair for quick gaging
- ▶ Produces crisp and clear color images in wide screen format
- ▶ Auto gain exposure setting to reduce glare
- ▶ On screen menu for quick access to camera settings

Product ID	Description
26100-252	Aven VGA Color Camera 720p

## Mighty Cam VGA Color Camera 1.3M w/SD Card

Aven's color VGA camera allows you to connect directly to a PC monitor. A PC not required for image processing, thus saving you bench space. In addition, a built in SD card allows you to save images. All features of this digital camera can be controlled via on screen menus, such as RGB values, white balance, cross hair grid, and auto exposure. 4 Vertical and 4 horizontal cross hair grids available with 6 color selections.



26100-253

- ▶ Compact 1.3M Color Camera with VGA Output
- ▶ Built in SD card for saving images
- ▶ Live/Freeze Image Function
- ▶ Multiple cross hair for quick gaging
- ▶ Produces crisp and clear color images in wide screen format
- ▶ Auto gain exposure setting to reduce glare

Product ID	Description
26100-253	Aven VGA Color Camera 1.3M w/ SD Card

## Mighty Cam 1080P HDMI Color Camera 2M w/ USB Flash Drive

Aven's 1080P HD color camera allows you to connect the camera directly to a HD monitor with an HDMI input. A PC is not required for image processing, thus saving you bench space. In addition, a built in USB Flash Drive allows you to save images. All features of this digital camera can be controlled via on screen menus, such as RGB values, white balance, cross hair grid, and auto exposure.



26100-253HD

- ▶ Connects directly to an HD monitor with HDMI input
- ▶ Built in USB Flash Drive for saving images
- ▶ Live/Freeze image function
- ▶ Multiple cross hair for quick gaging
- ▶ Produces stunning life like images with exceptional clarity

Product ID	Description
26100-253HD	Aven 1080P HDMI Color Camera 2M w/ USB Flash Drive

## Mighty Cam HDMI Color Camera 2.0M w/USB Flash Drive & Built in Measurement Software

Aven's color HDMI camera with built in USB Flash Drive and measurement software, is a simple solution to those that need to inspect and measure with accuracy. A PC is not required for image processing and no software to install. Images with measurement data can be saved to the built in USB Flash Drive using the remote trigger (included). Built in software includes the following features: Edge Detection, Live/Freeze Image, Measure line, circle, radius, angle and parallel lines.



26100-254

- ▶ Compact 720p Color Camera with VGA output
- ▶ Live/Freeze Image Function; Cross Hair for quick gaging
- ▶ Produces crisp and clear color images in wide screen format
- ▶ Auto gain exposure setting to reduce glare
- ▶ On screen menu for quick access to camera settings

Product ID	Description
26100-254	Aven HDMI Color Camera 2.0M w/SD Card



# Microscope & Video Accessories

Imaging & Measurement Software

## Measurement Camera Software for 26100-254

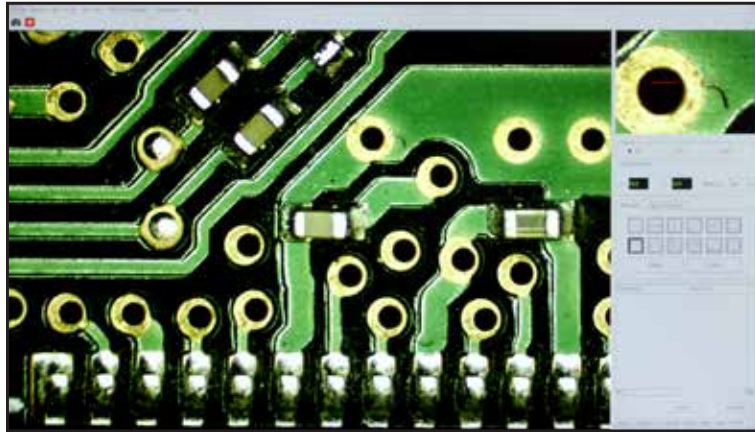

### Measure and Analyze with Ease

The advanced measurement software is able to detect gray scale gradations and can measure a line, circle, radius, angle and parallel lines in millimeters or inches. Users can save five sets of measurement data on the USB Flash Drive, which simplifies comparisons and record-keeping. White balance and exposure can be automatic or one-click mouse functions.



### Capture High Quality Images

Create enhanced still photos with or without measurement lines and save for further analysis.



### Optional Capture Settings

Software allows you to choose which image format to save files in (JPG or BMP) and also measurements you added to the image.



### Camera Settings

The software also allows you to edit all camera settings. Options include luminance, contrast, RGB values, auto exposure and auto white balance.



### Edge Detection Tool

Software has an Intelligent Edge detection tool built in for finding boundaries of objects within images. It works by detecting the discontinuities in brightness.

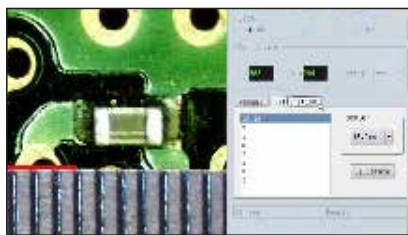

### Easy Measurement Calibration

Calibrating the software for measurement is as simple as placing a ruler or other scale under the lens, selecting the size, e.g. 16mm and pressing the Calibrate button.

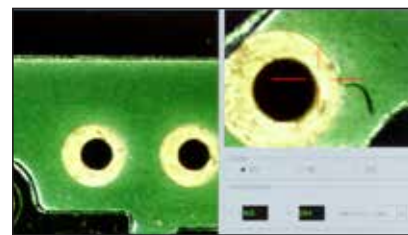

### Magnifying Window

Software digitally magnifies the area around the mouse pointer by 4x, 9x and 16x (selectable). This is particularly helpful when you need to see minute features.

### Additional Features

- ▶ Photo Browser displays images saved on USB Flash Drive and can be expanded to full screen for review
- ▶ Measurement results are displayed in the side panel and can be exported and saved on the USB Flash Drive
- ▶ Multiple measurement tools such as lines, parallel lines, circles and polygons (plotted with up to 10 points) are available in the Manual tab

\* Note: Aven recommends that you use a detented lens system or a microscope with click stops for accurate repeatable measurements.



# Microscope & Video Accessories

Imaging & Measurement Software

## ezMeasure® Software

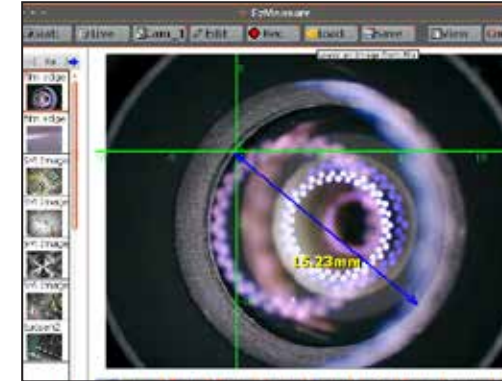

### Measure, Annotate and Analyze with Ease

ezMeasure® software allows you to measure, annotate, and analyze your images with just a few mouse clicks. Create written reports that include the raw data, plus the images involved. With ezMeasure® you can view realtime live images or screenshots from your saved folder which can be reviewed, replayed, and analyzed. Recent projects are easily accessible with thumbprint menu.

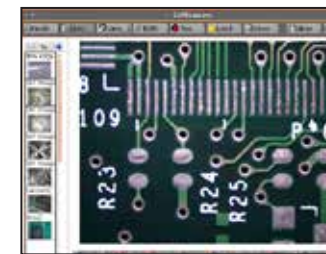

### Capture High Quality Images

Create enhanced still photos or record a live video stream for play back.

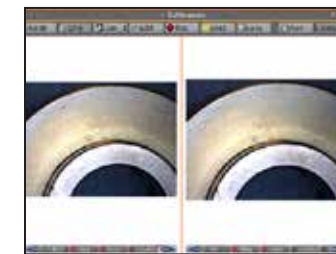

### Simultaneous Live Views

Use two cameras on same work station for side by side live views.

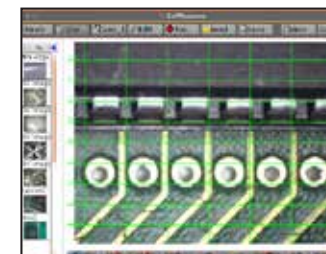

### Grid Feature

Locate and compare with ease using multiple grid views.



### Customize the Layout

Set the layout to your personal preferences and save your unique settings for future use.

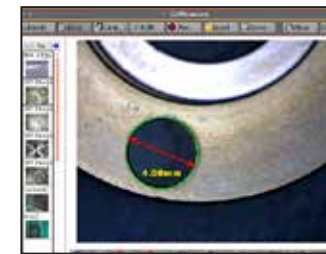

### Measurement Tools

- ▶ Set the image pixels to real units eg. mm or inches.
- ▶ Record and save multiple calibration settings.
- ▶ Measure the distances between different points, or edges.



### Text Button

Allows annotations directly onto the screen. The user has the ability to adjust the size and the appearance of the text.

### Additional Features

- ▶ Fill Mode Tool determines the image size: Fit-to-Fill the entire viewing area, Zoomed in, or Preserve the Original aspect ratio.
- ▶ Location Button provides a cursor for the X,Y,Z-axis coordinates. Moving the Cursor with the mouse updates the coordinates.
- ▶ And many many more ...

Product ID	Description
26100-406	ezMeasure® Software



# Microscope & Video Accessories

## Fiber Optic Illumination

### ProLux LED Fiber Optic Illuminator

- ▶ Accepts Virtually any Light Guide with Quick Change Adapters
- ▶ Advanced Heat Pipe Technology Using Metal Core PCB's
- ▶ Higher Brightness, Better Color, Longer Life, Half the Energy Consumption and Reduced Ownership Costs
- ▶ Linear Light Intensity Control with Continuous Dimming
- ▶ Maintenance Free LEDs Have a Minimum Lifetime of 25,000 Hours



26200A-300

### Fiber Optic Ring Light

- ▶ High quality glass fiber
- ▶ Provides 360° shadow free illumination
- ▶ Large fiber bundle ensures maximum light transmission
- ▶ Accepts polarizers
- ▶ Comes with standard 15.875mm (5/8") adapter
- ▶ Inner diameter 58.674mm (2.31")



26200A-402

Product ID	Description
26200A-402	Fiber Optic Ring Light

### Ring Light - Video Lenses

- ▶ High quality fiber
- ▶ Provides 360° shadow free illumination
- ▶ Large fiber bundle ensures maximum light transmission
- ▶ Comes with standard 15.875mm (5/8") adapter
- ▶ Inner diameter 28.58mm (1.125")
- ▶ Designed for use with Video Lenses



26200A-403

Product ID	Description
26200A-403	Ring Light - Video Lenses

### Polarizer for Fiber Optic Ring Lights

- ▶ Helps reduce glare
- ▶ Analyzer sits in Counterbore
- ▶ Low profile does inhibit placement of lens or object viewed



not  
26200A-402P

Product ID	Description
26200A-402P	Polarizer for Fiber Optic Ring Light

Product ID	Description
26200A-300	ProLux LED Fiber Optic Illuminator

### Dual Pipe Light Guide

- ▶ High quality fiber
- ▶ Large fiber bundle assures maximum light transmission
- ▶ Obedient "stay-up" Sheathing for accurate positioning
- ▶ Focusable lens on each pipe for individual light control



26200A-523

Product ID	Description
26200A-523	Dual Pipe Light Guide

### Fiber Optic Area Backlight - 4 x 4 in

- ▶ Ideal for high contrast silhouette images
- ▶ Highly diffuse even light distribution
- ▶ Sleek, slim design provides versatility for mounting in tight space



26200A-532

Product ID	Description
26200A-532	Fiber Optic Area Backlight - 4 x 4 in

### Illumination for Microscopy & Video Inspection

Aven offers a variety of lighting options. Eco-friendly white LED ring lights are designed to be used with standard microscopes and video lenses providing a stable bright light at a very low temperature. Fiber optic illuminators are often referred to as "cold light" illuminators because they provide high intensity focused light without the heat typically associated with high intensity lamps. Additional options include a ring light with polarizer for shiny surfaces as well as diffuse axial LED illuminator for specular & shiny surfaces.



www.aveninc.com



# Microscope & Video Accessories

## LED Illumination

### Diffuse Axial LED Illuminator

- ▶ Evenly illuminates flat and shiny surfaces
- ▶ Enhances scribed, indented or embossed features
- ▶ Creates contrast between specular, diffuse and/or absorptive surfaces
- ▶ Diminish visibility of clear overcoats or coverings
- ▶ Ideal for electronic component inspection



26200B-220

Product ID	Description
26200B-220	Diffuse Axial LED Illuminator

### Ring Light LED with Integrated Focus Mount

- ▶ Integrated LED ring light with focus mount with coarse and fine focus
- ▶ Eliminates chance of LED ring becoming loose from the microscope
- ▶ Increases working distance
- ▶ May be used with standard stand, articulating arm stand or either single or double arm boom stands\*



26200B-207

Product ID	Description
26200B-207	Ring Light LED with Integrated Focus Mount

### Ring Light LED with Polarizer

- ▶ Polarizer with Analyzer is ideal for illuminating shiny or highly reflective parts
- ▶ LED lights are flicker free, energy efficient and ecofriendly
- ▶ Operates at a low temperature and does not change color over time
- ▶ Inner diameter is 70mm (2.75") with three thumb screws for easy mounting



26200B-214

Product ID	Description
26200B-214	Ring Light LED with Polarizer

### Ring Light LED Triple Color

- ▶ 120 LEDs, 40 White, 40 Blue and 40 Red
- ▶ 7 Step Brightness Control
- ▶ Flicker Free
- ▶ No color change with temperature
- ▶ Energy efficient and eco friendly



26200B-213

Product ID	Description
26200B-213	Ring Light LED Triple Color

\* Note: When used with articulating stand, single arm boom stand, or double arm boom stand, an arbor (26800B-521) is required for mounting.

### Pro Series 40 LED Ring Light

- ▶ 40 powerful high precision aligned LEDs (white daylight)
- ▶ 4 quadrant controller and auto voltage sensing power supply
- ▶ Machined aluminum alloy housing for durability
- ▶ Fully adjustable dimming control
- ▶ 360° shadow free illumination



26200B-217

Product ID	Description
26200B-217	Pro Series 40 LED Ring Light

### LED Ring Light w/Brightness and Sector Control

- ▶ 60 High Intensity LED Lights
- ▶ 7 Step Brightness Control
- ▶ 4 sectors and each can be controlled independently
- ▶ Flicker Free
- ▶ No color change with temperature



26200B-211

Product ID	Description
26200B-211	LED Ring Light w/Brightness and Sector Control

### LED Ring Light w/Brightness and Sector Control

- ▶ 72 High Performance LED Lights
- ▶ Continuous Brightness Control
- ▶ 4 sectors and each can be controlled independently
- ▶ Flicker Free
- ▶ No color change with temperature



26200B-212

Product ID	Description
26200B-212	LED Ring Light w/Brightness and Sector Control

### Ring Light Adaptor

- ▶ Allows for secure mounting of ring lights to DSZ, NSW and SPZ Series Microscopes
- ▶ Screws onto bottom of microscope body



26800B-460

Product ID	Description
26800B-460	Ring Light Adaptor

### Protective Lens Cover

- ▶ Glass fitted inside metal ring with threaded screw
- ▶ Mounts to bottom of microscope body
- ▶ Useful when soldering under the microscope
- ▶ Protects fumes from damaging the microscope lenses



26800B-465

Product ID	Description
26800B-465	Protective Lens Cover



# Microscope & Video Accessories

## Stands & Focus Mounts

### Single Arm Boom Stand w/Heavy Metal Base

- ▶ Base dimensions: 285 x 260 x 18mm (11.22" x 10.23" x 0.71")
- ▶ Vertical post length: 384mm (15.12")
- ▶ Heavy base provides excellent stability
- ▶ Allows positioning of microscopes over large area
- ▶ Posts are highly polished for smooth operation



26800B-519

### Pole Stand with Focus Mount

- ▶ Base dimensions: 210 x 278 x 25mm (8.26" x 10.94" x 0.98")
- ▶ Vertical post length: 255mm (10")
- ▶ Includes rack & pinion focus mount with fine focus adjustment
- ▶ Frosted, Black & White Stage Plates
- ▶ Safety clamp included



26800B-509

Product ID	Description
26800B-509	Pole Stand with Focus Mount

### Single Arm Boom Stand w/Heavy Duty Clamp

- ▶ Vertical post length: 384mm (15.12")
- ▶ Smooth movement of a ball bearing slide allows easy positioning of microscope over object being viewed
- ▶ Heavy duty C Clamp provides stability and saves bench space
- ▶ Allows positioning of microscopes over large area



26800B-525

### Pole Stand with Focus Mount with LED Illumination Top and Bottom

- ▶ Base dimensions: 210 x 278 x 40mm (8.26" x 10.94" x 1.57")
- ▶ Vertical post length: 255mm (10")
- ▶ Includes rack & pinion focus mount with fine focus adjustment
- ▶ Top & Bottom LED illumination with dimmer control
- ▶ Frosted, Black & White Stage Plates
- ▶ Safety clamp included



26800B-510

Product ID	Description
26800B-510	Pole Stand with Focus Mount with LED Illumination Top and Bottom

### Double Arm Boom Stand w/Heavy Metal Base

- ▶ Base dimensions: 285 x 260 x 18mm (11.22" x 10.23" x 0.71")
- ▶ Vertical post length: 384mm (15.12")
- ▶ Heavy Base couples with ball bearing slide allows for easy positioning of the microscope
- ▶ 605mm height available with extension post



26800B-534

### Track Stand with Focus Mount with LED Illumination Top and Bottom

- ▶ Base dimensions: 210 x 278 x 40mm (8.26" x 10.94" x 1.57")
- ▶ Tracking range: 245mm (9.65")
- ▶ Light weight compact track stand
- ▶ Comes with rack & pinion focus mount with fine focus adjustment
- ▶ Top & Bottom LED illumination with dimmer control
- ▶ Frosted, Black & White Stage Plates



26800B-508

Product ID	Description
26800B-508	Track Stand with Focus Mount with LED Illumination Top and Bottom

### Double Arm Boom Stand w/Heavy Duty Clamp

- ▶ Vertical post length: 384mm (15.12")
- ▶ Smooth movement of a ball bearing slide allows easy positioning of microscope over object being viewed
- ▶ Heavy duty C Clamp provides stability and saves bench space
- ▶ Allows positioning of microscopes over large area



26800B-536

### Pole Stand with Focus Mount and LED Illumination

- ▶ Base dimensions: 220 x 284 x 15mm (8.6" x 11" x 0.6")
- ▶ Vertical post length: 255mm (10")
- ▶ Light weight compact stand
- ▶ Comes with rack & pinion focus mount with course and fine adjustment knobs
- ▶ Built in 60 LED ring light with dimmer control



26800B-512

Product ID	Description
26800B-512	Pole Stand with Focus Mount and LED Illumination

Note: Pole stands are not suitable for SPZ Series microscopes with 0.5x lens as vertical post is not long enough to accommodate the working distance.

Note: Single & Double Arm Boom Stands require either a Focus Mount (26800B-517) with tiltable arbor (26800B-521) or E-Arm Focus Mount (26800B-518).

# Microscope & Video Accessories

## Stands & Focus Mounts

### Diffuser for Glare Reduction

- ▶ Helps reduce glare from shiny objects
- ▶ Made from durable plastic material
- ▶ Ideal for observing solder joints, metallic parts or shiny surfaces
- ▶ Designed for use with 26800B-512 (Stand PLED) and 26200B-207 (Ring Light with Focus Mount)



26200B-209DF2

Product ID	Description
26200B-209DF2	Diffuser for Glare Reduction

### Pole Stand with Focus Mount

- ▶ Base dimensions: 220 x 284 x 15mm (8.66" x 11.18" x 0.59")
- ▶ Vertical post length: 250mm (10")
- ▶ Light weight compact stand
- ▶ Ideal for examining small parts
- ▶ Saves bench space
- ▶ Includes with rack & pinion focus mount with course and fine adjustment knobs



26800B-511

Product ID	Description
26800B-511	Pole Stand with Focus Mount

### Light Weight Articulating Arm Stand

- ▶ Allows great flexibility in positioning microscopes
- ▶ Light weight and compact design
- ▶ Easy height adjustment
- ▶ Aluminum and ABS Plastic construction



26800B-555

Product ID	Description
26800B-555	Light Weight Articulating Arm Stand

### Standard Articulating Arm Stand

- ▶ Allows great flexibility in positioning microscopes
- ▶ Can be moved out of way when not in use
- ▶ All metal construction



26800B-560

Product ID	Description
26800B-560	Standard Articulating Arm Stand

### LCD Monitor Mount

- ▶ Improves productivity with expanded workspace and high ergonomic comfort
- ▶ Arms have 360 degree swivel and rotation and -15 to +15 degree tilt adjustment
- ▶ Made of high grade steel and aluminum
- ▶ Holds Widescreen Display up to 27"
- ▶ Heavy duty "C" clamp mounts to desktop providing excellent stability



26700-410

Product ID	Description
26700-410	LCD Monitor Mount, 512 Series, Post Height 17-in
26700-411	LCD Monitor Mount, 542 Series, Post Height 12-in

### Gemology Stand with Fluorescent and Halogen Illumination

- ▶ Independently controllable fluorescent front light provides even shadow free illumination
- ▶ Dimmable halogen transmitted and pipe light with separate controls
- ▶ 2 post positioning, right and left for adjustable gem tweezers
- ▶ Adjustable iris in dark field attachment
- ▶ Stand can be inclined from 0 to 10 degree



26800B-507

Product ID	Description
26800B-507	Gemology Stand with Fluorescent and Halogen Illumination

### Heavy Duty Post Stand

- ▶ Base dimension: 279 x 330 x 12.7mm (10.98" x 13" x 0.5")
- ▶ Vertical post length: 406mm (15.98")
- ▶ Aluminum powder coated base
- ▶ 10 tapped holes for mounting x-y stages
- ▶ UNC bolt and safety clamp included
- ▶ Vertical post will accept focus mount (26800B-517) to which bodies SPZH, SPZ series, DSZ series and NSW series can be mounted



26800B-570

Product ID	Description
26800B-570	Heavy Duty Post Stand

### Focus Mount

- ▶ Coarse & Fine Focus Adjustments
- ▶ Precision Rack & Pinion Mechanism with Tension Control
- ▶ 74mm diameter ring
- ▶ Will accept our SPZH, SPZ, DSZ and NSW series microscopes



26800B-517

Product ID	Description
26800B-517	Focus Mount

### E-Arm Focus Mount

- ▶ Rack & Pinion Mechanism with Coarse Focus Adjustment
- ▶ 50mm focusing distance in vertical direction
- ▶ 74mm diameter ring
- ▶ Mounts to any of our boom stands or articulating arm stands



26800B-518

Product ID	Description
26800B-518	E-Arm Focus Mount

### Tiltable Arbor

- ▶ Designed to extend the working range of boom stands and articulating arm stands
- ▶ Allows tilting of microscope bodies to increase operator comfort



26800B-521

Product ID	Description
26800B-521	Tiltable Arbor



# Microscope & Video Accessories

## Gliding Stages & Eyepieces

### Gliding Stage w/Micrometer Adjustments

- ▶ Enables attachment of micrometer for accurate measurement
- ▶ Stage measures 114 x 114mm
- ▶ 25 x 25mm travel



26800B-471

Product ID	Description
26800B-471	Gliding Stage w/Micrometer Adjustments

### Gliding Stage-Small

- ▶ Ideal for observing parts that need to be moved while under the microscope
- ▶ Provides smooth movement in x and y axis
- ▶ Measures 140 x 114mm
- ▶ 94 x 114mm travel



26800B-472

Product ID	Description
26800B-472	Gliding Stage-Small

### Gliding Stage w/95mm Ring Mount

- ▶ Smooth motion for precise specimen placement
- ▶ Anodized black metal and glass components
- ▶ Glass top with interior Y and exterior X unit measurements
- ▶ Coaxial dial system for easy and accurate operation
- ▶ Useful for dissection and circuit board inspection



26800B-477

Product ID	Description
26800B-477	Gliding Stage w/95mm Ring Mount

### Gliding Stage-Large

- ▶ Precision-machined bevel-cut gearing
- ▶ Fine, controlled movement along the entire 300x200mm travel in the X-Y axis
- ▶ Black anodized finish
- ▶ Ideal for smooth and controlled movement of parts underneath a microscope



26800B-478

Product ID	Description
26800B-478	Gliding Stage-Large

### Microscope Eyepiece 10x with 10:100mm Scale

- ▶ 10x magnification power
- ▶ 10:100mm scale reticle
- ▶ Excellent for measurement
- ▶ High Eye-point Design
- ▶ 20mm Super Wide Field of View



26800B-455

Product ID	Description
26800B-455	Microscope Eyepiece 10x with 10:100mm scale

### Microscope Eyepiece 10x with 5:100mm Scale

- ▶ 10x magnification power
- ▶ 5:100mm scale reticle
- ▶ Excellent for measurement
- ▶ High Eye-point Design
- ▶ 20mm Super Wide Field of View



26800B-456

Product ID	Description
26800B-456	Microscope Eyepiece 10x with 5:100mm scale

### Microscope Eyepiece 10x with 20x20 0.5mm Squares

- ▶ 10x magnification power
- ▶ 20x20, 0.5mm squares reticle
- ▶ Excellent for measurement
- ▶ High Eye-point Design
- ▶ 20mm Super Wide Field of View



26800B-457

Product ID	Description
26800B-457	Microscope Eyepiece 10x with 20x20 0.5mm Squares

### Microscope Eyepiece 10x with 10x10 1mm Squares

- ▶ 10x magnification power
- ▶ 10x10, 1mm squares reticle
- ▶ Excellent for measurement
- ▶ High Eye-point Design
- ▶ 20mm Super Wide Field of View



26800B-458

Product ID	Description
26800B-458	Microscope Eyepiece 10x with 10x10 1mm Squares

### Microscope Eyepiece 10x with 10:100mm Scale Cross Hair

- ▶ 10x magnification power
- ▶ 10:100mm scale cross hair reticle
- ▶ Excellent for measurement
- ▶ High Eye-point Design
- ▶ 20mm Super Wide Field of View



26800B-459

Product ID	Description
26800B-459	Microscope Eyepiece 10x with 10:100mm Scale Cross Hair

# Microscope & Video Accessories

## Eyepieces & Auxiliary Lenses

### DSW-10X Eyepieces - DSZ-44 and NSW series bodies

- ▶ Wide Field 10x Eyepieces
- ▶ For DSZ-44 and NSW Series Microscopes
- ▶ FN 23



26800B-441

Product ID	Description
26800B-441	DSW-10X Eyepieces - DSZ-44 and NSW series bodies

### DSW-15X Eyepieces - DSZ and NSW series bodies

- ▶ Wide Field 15x Eyepieces
- ▶ For DSZ-44, DSZ-70 and NSW Microscopes
- ▶ FN 15



26800B-442

Product ID	Description
26800B-442	DSW-15X Eyepieces - DSZ and NSW series bodies

### DSW-20X Eyepieces - DSZ and NSW series bodies

- ▶ Wide Field 20x Eyepieces
- ▶ For DSZ-44, DSZ-70 and NSW Microscopes
- ▶ FN 11.4



26800B-443

Product ID	Description
26800B-443	DSW-20X Eyepieces - DSZ and NSW series bodies

### DSW-10X Eyepieces - DSZ-70 series bodies

- ▶ Wide Field 10x Eyepieces
- ▶ For DSZ-70 Microscopes
- ▶ FN 20



26800B-445

Product ID	Description
26800B-445	DSW-10X Eyepieces - DSZ-70 series bodies

### DHW-10X Eyepieces - SPZ series bodies

- ▶ Wide Field 10x Eyepieces
- ▶ For SPZ Series Microscopes
- ▶ FN 23



26800B-448

Product ID	Description
26800B-448	DHW-10X Eyepieces - SPZ series bodies

### DHW-15X Eyepieces - SPZ series bodies

- ▶ Wide Field 15x Eyepieces
- ▶ For SPZ Series Microscopes
- ▶ FN 15



26800B-449

Product ID	Description
26800B-449	DHW-15X Eyepieces - SPZ series bodies

### DHW-20X Eyepieces - SPZ series bodies

- ▶ Wide Field 20x Eyepieces
- ▶ For SPZ Series Microscopes
- ▶ FN 11.4



26800B-450

Product ID	Description
26800B-450	DHW-20X Eyepieces - SPZ series bodies

### Rubber Eye Guards

- ▶ Adds comfort
- ▶ Manufactured from stretchable rubber material
- ▶ Eliminates stray light
- ▶ Protects eyepieces



26800B-453

Product ID	Description
26800B-452	Rubber Eye Guards - DSW eyepieces
26800B-453	Rubber Eye Guards - DHW eyepieces

### Auxiliary Lens 0.5x

- ▶ Reduces magnification of DSZ, NSW, SPZH and SPZ series microscopes
- ▶ Increases working distance and field of view
- ▶ 0.5x lens cannot be used with SPZ series bodies with stand P, PFM, PLED and Stand T and NSW series bodies with Stand T



26800B-461

Product ID	Description
26800B-461	Auxiliary Lens 0.5x

### Auxiliary Lens 0.75x

- ▶ Reduces magnification of DSZ, NSW, SPZH and SPZ series microscopes
- ▶ Increases working distance and field of view



26800B-462

Product ID	Description
26800B-462	Auxiliary Lens 0.75x

### Auxiliary Lens 1.6x

- ▶ Increases magnification of DSZ, NSW, SPZH and SPZ series microscopes
- ▶ Reduces working distance and field of view



26800B-463

Product ID	Description
26800B-463	Auxiliary Lens 1.6x

### Auxiliary Lens 2x

- ▶ Increases magnification of DSZ, NSW, SPZH and SPZ series microscopes
- ▶ Reduces working distance and field of view



26800B-464

Product ID	Description
26800B-464	Auxiliary Lens 2x







# Magnifiers

Inspection Loupes, Magnifiers & Magniloupes

## Swing Out Inspection Loupe 10x Hex

- ▶ Triplet lens system corrected for spherical and chromatic aberrations
- ▶ Produces a sharp and distortion free image
- ▶ 10x magnification



26010

Product ID	Description
26010	Swing Out Inspection Loupe 10x Hex

## Swing Out Inspection Loupe 10x

- ▶ Distortion free, three piece, bonded lens
- ▶ Made from optical glass
- ▶ 10x eye loupe with 1" working distance
- ▶ Chrome finish loupe easily folds up to protect lens
- ▶ Includes leather carrying case



26011

Product ID	Description
26011	Swing Out Inspection Loupe 10x

## Swing Out Inspection Loupe 20x

- ▶ Distortion free, three piece, bonded lens
- ▶ Made from optical glass
- ▶ 20x eye loupe with 1/2" working distance
- ▶ Chrome finish loupe easily folds up to protect lens
- ▶ Includes leather carrying case



26012

Product ID	Description
26012	Swing Out Inspection Loupe 20x

## Magnifier 10x

- ▶ Pre-focused dual lenses allow examination of objects close-up
- ▶ Transparent acrylic base permits ambient light to illuminate the object
- ▶ Powerful 10x magnification
- ▶ Ideal for model makers, stamp and coin collectors, and photography



26051

Product ID	Description
26051	Magnifier 10x

## Magniloupe w/Cushion

- ▶ Lightweight glass lens magnifier
- ▶ Soft rubber cushion provides comfort during use
- ▶ Powerful magnification
- ▶ Excellent for close inspection of small parts
- ▶ Ideal for use by jewelers, photographers, watchmakers, printers, and quality control inspectors



26041

Product ID	Description
26041	8x Magniloupe w/Cushion
26042	7x Magniloupe w/Cushion
26043	4.5x Magniloupe w/Cushion

## Eye Loupe 10x

- ▶ Lightweight & sturdy glass lens magnifier
- ▶ Powerful 10x magnification
- ▶ Excellent for close inspection of small parts
- ▶ Rests comfortably in the eye socket
- ▶ Ideal for use by jewelers, photographers, watchmakers, printers, and quality control inspectors



26034

Product ID	Description
26034	Eye Loupe 10x

## Eye Loupe 10x with LED Light

- ▶ Lightweight glass lens magnifier
- ▶ Powerful 10x magnification
- ▶ Excellent for close inspection of small parts
- ▶ Adjustable, bright LED light
- ▶ Ideal for use by jewelers, photographers, watchmakers, printers, and quality control inspectors



26034-LED

Product ID	Description
26034-LED	Eye Loupe 10x with LED Light

## User Pairs Mighty Scope with a Low-Tech Companion

Performance matters more than size, as our popular Mighty Scope Digital Microscope shows.

We and our sales representatives hear manufacturing engineers praise the handheld scope's convenience for inline inspection, image and video capture, and monitor viewing via USB or the Wi-Fi model. The latest field report comes from a user who called to describe how he previously used an eye loupe with a scale-measuring reticle for parts check to assure that any defects are within tolerances.

Cleverly, he now pairs a newly purchased Mighty Scope 5M with his original tool to combine the loupe's scale with our instrument for a close-up, measurable view illuminated with six LEDs. The Mighty Scope can capture that combined image for reference and sharing.



Visit Our Blog



www.aveninc.com



# Magnifiers

Eye Loupes & Pocket Microscopes

## Pen Type Microscope 25x w/LED Light

- ▶ Perfect "pen-type" microscope with 25x magnification
- ▶ Includes pocket clip and a bright LED light
- ▶ Beveled opening to gather and focus light
- ▶ Provides distortion free inverted image
- ▶ Ideal for inspection in electronics, medical, printing, and jewelry industries



26800C-550

Product ID	Description
26800C-550	Pen Type Microscope 25x w/LED Light

## Pen Type Microscope 50x w/LED Light

- ▶ Perfect "pen-type" microscope with 50x magnification
- ▶ Includes pocket clip and a bright LED light
- ▶ Beveled opening to gather and focus light
- ▶ Provides distortion free inverted image
- ▶ Ideal for inspection in electronics, medical, printing, and jewelry industries



26800C-551

Product ID	Description
26800C-551	Pen Type Microscope 50x w/LED Light

## Pen Type Microscope 25x w/LED Light & Scale

- ▶ Perfect "pen-type" microscope with 25x magnification and includes reticle scale
- ▶ Includes pocket clip and a bright LED light
- ▶ Beveled opening to gather and focus light
- ▶ Provides distortion free inverted image
- ▶ Ideal for inspection in electronics, medical, printing, and jewelry industries



26800C-552

Product ID	Description
26800C-552	Pen Type Microscope 25x w/LED Light & Scale

## Pen Type Microscope 50x w/LED Light & Scale

- ▶ Perfect "pen-type" microscope with 50x magnification and includes reticle scale
- ▶ Includes pocket clip and a bright LED light
- ▶ Beveled opening to gather and focus light
- ▶ Provides distortion free inverted image
- ▶ Ideal for inspection in electronics, medical, printing, and jewelry industries



26800C-553

Product ID	Description
26800C-553	Pen Type Microscope 50x w/LED Light & Scale

## Pocket Microscope 40x w/ illumination

- ▶ Perfect carry-with microscope with magnification of 40x
- ▶ Eyepiece has scale with 0.1mm graduation and a measurement range of 4mm
- ▶ Operates on two AA batteries (not included)
- ▶ Useful for engineers, tool makers and quality control inspectors



26800C-534

Product ID	Description
26800C-534	Pocket Microscope 40x w/illumination

## Pocket Microscope 40x w/ illumination

- ▶ Perfect carry-with microscope with magnification of 40x
- ▶ Eyepiece has scale with 0.05mm graduation and a measurement range of 2mm
- ▶ Operates on three AA batteries (not included)
- ▶ Useful for engineers, tool makers and quality control inspectors



26800C-541

Product ID	Description
26800C-541	Pocket Microscope 40x with LED illumination

## Pocket Microscope 60-100x w/ LED illumination

- ▶ Perfect carry-with microscope with magnification of 60-100x
- ▶ Focus wheel allows you to quickly focus onto the object being viewed
- ▶ Operates on three LR1130 Button Cell batteries (not included)
- ▶ Useful for engineers, tool makers and quality control inspectors



26800C-542

Product ID	Description
26800C-542	Pocket Microscope 60-100x with LED illumination

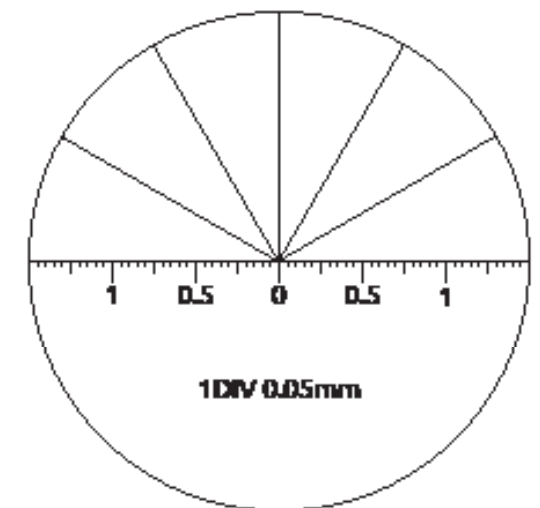

Pen Type Microscope Scale  
Etched into the eyepiece with graduations of 0.05mm  
26800C-552 & 26800C-553



### OptiVisor Headband Magnifiers

- ▶ Optical glass prismatic lenses ground and polished to precision optical standards
- ▶ Adjustable pivots allow the visor to be tilted out of the way when not needed and at your fingertips when you need magnification
- ▶ Adjusts to fit all head sizes
- ▶ High impact visor provides a tough, durable, always-new appearance
- ▶ Padded orthopedic felt adds to comfort



26101

Product ID	Description
26101	OptiVisor Headband Magnifier - 1.5x
26102	OptiVisor Headband Magnifier - 1.75x
26103	OptiVisor Headband Magnifier - 2x
26104	OptiVisor Headband Magnifier - 2.5x
26105	OptiVisor Headband Magnifier - 2.75x
26106	OptiVisor Headband Magnifier - 3.5x

### Replacement Lenses

- ▶ 1.5x - 3.5x Replacement Lenses
- ▶ Optical glass prismatic lenses ground and polished to precision optical standards
- ▶ Replacement Lens for OptiVisor Headband Magnifier



26107

Product ID	Description
26107	Replacement Lens #2 - 1.5x
26108	Replacement Lens #3 - 1.75x
26109	Replacement Lens #4 - 2x
26110	Replacement Lens #5 - 2.5x
26111	Replacement Lens #7 - 2.75x
26112	Replacement Lens #10 - 3.5x

### Auxiliary Lens - 2.5x

- ▶ Attaches to the front of OptiVisor headband magnifier
- ▶ Mounts on one side of the lens plate to provides an additional 2-1/2X magnification
- ▶ Pivots out of the way when not needed



26113

Product ID	Description
26113	Auxiliary Lens - 2.5x

## Magnifiers

Headband Magnifiers

### Headband Magnifier with LED Light

- ▶ Excellent for quality control inspection
- ▶ Removable LED lamp can be used as a free standing light source
- ▶ Includes four clip-on lenses (1.5x, 2x, 2.5x, and 3x)
- ▶ Headband is adjustable to fit all sizes
- ▶ Ideal for close up inspection of small parts



26221

Product ID	Description
26221	Headband Magnifier with LED Light

### OptiSight Headband Magnifier

- ▶ Visor can be worn over Prescription or safety glasses
- ▶ Durable high-strength plastic
- ▶ Interchangeable lenses 1.75x, 2x, 2.5x
- ▶ Visor design shields out unwanted glare
- ▶ Precision optical grade acrylic prismatic lens.



26224

Product ID	Description
26224	OptiSight Headband Magnifier

### OptiVue Headband Magnifier - 2.5x

- ▶ Provides hands-free magnification
- ▶ Visor tilts up for normal viewing
- ▶ Includes 2.5x crystal clear acrylic lens
- ▶ Adjustable headband fits any size



26225

Product ID	Description
26225	OptiVue Headband Magnifier - 2.5x

Register online to receive updates on the newest products and for the latest specials from Aven.

## Magnifying Lamps

ProVue Lamps & Accessories

### ProVue SuperSlim Magnifying Lamp

- ▶ Available in two configurations: 5-Diopter (2.25x) and 8-Diopter (3x Magnification)
- ▶ 5" crystal clear glass lens for 360° distortion-free viewing
- ▶ 36" spring balanced arm stays set in any position
- ▶ Heavy-duty mounting clamp with 63.5mm (2.5") opening
- ▶ Fluorescent model features 22 Watt bulb operating at 6400k
- ▶ LED models feature 60 high powered energy efficient SMD LEDs lights that provide shadow free illumination
- ▶ LED lights are rated for over 20,000 hours of use
- ▶ Unit operates at 115 VAC



26501-LED

Product ID	Description	Lighting	Magnification
26501-SIV	ProVue Magnifying Lamp	22W fluorescent	2.25x (5 diopter)
26501-LED	ProVue LED Magnifying Lamp	60 SMD LED	2.25x (5 diopter)
26501-LED-8D	ProVue LED Magnifying Lamp	60 SMD LED	3x (3 diopter)

### ProVue Magnifying Lamp LED with Rolling Stand

- ▶ Same features as our 26501-LED except mounted on our heavy duty floor stand with casters



26501-LED-STN

Product ID	Description
26501-LED-STN	ProVue Magnifying Lamp LED with Rolling Stand

### ProVue Deluxe Magnifying Lamp (discontinued)

- ▶ Available in two configurations with different lighting
- ▶ 5" - 2.25x(5 diopter) crystal clear glass lens for 360° distortion free viewing
- ▶ 35" heavy duty resistive arm stays set in any position
- ▶ Heavy-duty metal mounting clamp with 63.5mm (2.5") opening
- ▶ Fluorescent model features 22 Watt bulb operating at 6400k
- ▶ LED models feature high powered energy efficient SMD LEDs lights provide shadow free illumination
- ▶ LED lights are rated for over 20,000 hours of use
- ▶ Unit operates at 115 VAC



26501-

Product ID	Description	Lighting	Magnification
26501-DSG	ProVue Deluxe Magnifying Lamp	22W fluorescent	2.25x (5 diopter)
26501-DSG-LED	ProVue Deluxe Magnifying Lamp	45 SMD LED	2.25x (5 diopter)



### 22-watt Replacement Bulb

- ▶ Replacement bulb for 26501-SIV and 26501-DSG
- ▶ Universal standard fluorescent light
- ▶ Energy efficient
- ▶ Rated lifetime of 12,000 hours



26501-B22

Product ID	Description
26501-B22	22-watt Replacement Bulb

### ProVue Deluxe LED Magnifying Lamp

- ▶ Energy efficient 72 SMD LED board
- ▶ 5 Diopter Glass Lens
- ▶ 36" Friction Arms. No springs, no pinch hazards
- ▶ Beautifully constructed aluminium design
- ▶ Built-in brightness control
- ▶ 3 locking joints. Stays in place in any position
- ▶ Minimum lifetime of 20,000 hours



26501-DSG-LED

Product ID	Description
26501-DSG-LED	ProVue Deluxe LED Magnifying Lamp

### Auxiliary Lens - 3-Diopter (1.75x)

- ▶ Provides additional magnification
- ▶ 3.875" 1.75x (3 diopter) auxiliary lens
- ▶ Designed to attach to bottom of Aven 26501-DSG magnifying lamp



26501-AL3

Product ID	Description
26501-AL3	Auxiliary Lens - 3-Diopter (1.75x)

### Swing-Away Lens - 5-Diopter (2.25x)

- ▶ Provides additional magnification
- ▶ 5 diopter (2.25x)
- ▶ Works with all magnifying lamps



26501-SLA

Product ID	Description
26501-SLA	Swing-Away Lens - 5-Diopter (2.25x)

### ProVue Replacement Clamp

- ▶ Heavy-duty metal mounting clamp with 63.5mm (2.5") opening
- ▶ Mounts easily to desk or table top
- ▶ Fits ProVue magnifying lamps



26501-RC

Product ID	Description
26501-RC	ProVue Replacement Clamp



# Magnifying Lamps

ProVue Slim & Touch LED Magnifying Lamps

## ProVue Touch White & UV LED Magnifying Lamp

- ▶ Dual lighting provides 54 powerful energy saving white SMD LED lights and 48 SMD UV LED lights (400nm)
- ▶ UV lighting ideal for forensic analysis, counterfit inspection and detection of fluoresces in adhesives, laminates and conformal coating
- ▶ SMD technology ensures reliability and long life
- ▶ Large 7" crystal clear 1.75x (3 diopter) glass lens with protective cover
- ▶ Touch sensitive 3-stage on-off switch for controlling light intensity
- ▶ Rugged ABS plastic housing attached to a 35" industrial grade spring balance arm for precise positioning
- ▶ Lens can be easily removed and replaced when necessary
- ▶ Built-in metal grips for quick and easy positioning
- ▶ Heavy duty metal mounting clamp with 89mm (3.5") opening
- ▶ LED lights are rated for over 20,000 hours of use
- ▶ Unit operates at 115 to 240 VAC



26508-LDV

Product ID	Description
26508-LDV	ProVue Touch White & UV LED Magnifying Lamp

## Floor Stand Heavy Duty with Castors

- ▶ 5 full swivel castors for easy mobility
- ▶ Designed for durability
- ▶ Easy to clean, no maintenance required
- ▶ Provides full mobility for magnifying lamp applications in beauty salons, the medical field, electronics repair, dental clinics, industrial inspection, scientific research laboratories and even at home
- ▶ Works with all Aven magnifying lamps except the 26501-DSG and 26501-DSG-LED

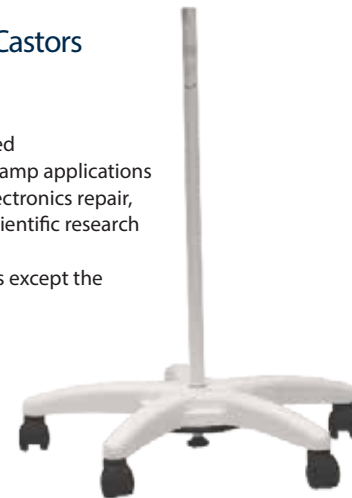

26509-STN

Product ID	Description
26509-STN	Floor Stand Heavy Duty with Castors

## ProVue Touch Magnifying Lamp w/ LED Illumination

- ▶ 54 powerful energy saving white SMD LEDs provide shadow free illumination
- ▶ SMD technology ensures reliability and long life
- ▶ Large 7" crystal clear 1.75x (3 diopter) glass lens with protective cover
- ▶ Touch sensitive 3-stage on-off switch for controlling light intensity
- ▶ Rugged ABS plastic housing attached to a 35" industrial grade spring balance arm for precise positioning
- ▶ Lens can be easily removed and replaced when necessary
- ▶ Built-in metal grips for quick and easy positioning
- ▶ Heavy duty metal mounting clamp with 89mm (3.5") opening
- ▶ LED lights are rated for over 20,000 hours of use
- ▶ Unit operates at 115 to 240v VAC



26508-LED

Product ID	Description
26508-LED	ProVue Slim LED Magnifying Lamp

Register online to receive updates on the newest products and for the latest specials from Aven.



# Magnifying Lamps

Mighty Vue Lamps & Accessories

## Mighty Vue Magnifying Lamp-LED

- ▶ Durable safe mar-resistant plastic housing
- ▶ Large 7" x 6" 1.75x (3 diopter) lens
- ▶ 36 high-powered energy efficient SMD LEDs provide shadow-free illumination
- ▶ 32" spring balanced arm stays put in any position
- ▶ Heavy-duty metal mounting clamp with 63.5mm (2.5") opening
- ▶ LED lights are rated for over 20,000 hours of use
- ▶ Unit operates at 115 VAC

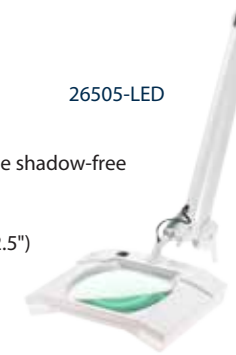

26505-LED

Product ID	Description
26505-LED	Mighty Vue Magnifying Lamp-LED

## Mighty Vue Magnifying Lamp LED with Rolling Stand

- ▶ Same features as our 26505-LED except mounted on our heavy duty floor stand with casters



26505-LED-STN

Product ID	Description
26505-LED-STN	Mighty Vue Magnifying Lamp LED with Rolling Stand

## Mighty Vue Pro Magnifying Lamp

- ▶ Available in two configurations with different magnifications
- ▶ Large 7" x 6" lens
- ▶ Durable ESD safe mar-resistant plastic housing
- ▶ 36" spring balanced arm stays put in any position
- ▶ Heavy-duty ESD safe metal mounting clamp with 63.5mm (2.5") opening
- ▶ Color temperature ranges from 3500K-6500K
- ▶ Feature 60 high powered energy efficient SMD LEDs lights (30 per color temperature) that provide shadow free illumination
- ▶ LED lights are rated for over 20,000 hours of use
- ▶ Features Brightness Adjustment (max: 1100lm)
- ▶ Unit operates at 115 VAC



26505-ESL-XL5

Product ID	Description	Lighting	Magnification
26505-ESL-XLe	Mighty Vue Magnifying Lamp ESD Safe (black)	60 SMD LED	2.25x (5 diopter)
26505-ESL-5D	Mighty Vue Magnifying Lamp (white)	60 SMD LED	1.75x (3 diopter)

## Mighty Vue Magnifying Lamp

- ▶ Durable mar-resistant plastic housing
- ▶ Large 7" x 6" 1.75x (3 diopter) lens
- ▶ Two 9W Fluorescent bulbs operating a 6400K
- ▶ 32" spring balanced arm stays put in any position
- ▶ Heavy-duty metal mounting clamp with 63.5mm (2.5") opening
- ▶ Unit operates at 115 VAC



26505-SIV

Product ID	Description
26505-SIV	Mighty Vue Magnifying Lamp

## 9 Watt Replacement Bulb

- ▶ 9 Watt Replacement bulb designed for Mighty Vue Magnifiers
- ▶ Color temperature 6400K
- ▶ Energy efficient universal standard fluorescent light



26505-B09

Product ID	Description
26505-B09	9 Watt Replacement Bulb

## Replacement Clamp - 26505-SIV

- ▶ Replacement Heavy-duty metal mounting clamp with 63.5mm (2.5") opening
- ▶ Mounts easily to desk or table top
- ▶ Fits Mighty Vue 26505-SIV and 26505-LED magnifying lamps



26505-RC

Product ID	Description
26505-RC	Replacement Clamp - 26505-SIV

## Replacement Clamp - 26505-ESD

- ▶ Replacement Heavy-duty metal mounting clamp with 63.5mm (2.5") opening
- ▶ Mounts easily to desk or table top
- ▶ Fits Mighty Vue 26505-ESD and 25505-ESD-5D magnifying lamps



26505-RC-ESD

Product ID	Description
26505-RC-ESD	Replacement Clamp - 26505-ESD

### Sirrus Task Light LED w/ Swivel Head, 500mm Flex Arm & Mounting Clamp

- ▶ 500mm flexible arm stays set in any position to provide direct light where needed
- ▶ High intensity energy saving LEDs
- ▶ Cool operating temperature
- ▶ Exceptionally long LED element life (minimum 20,000 hours)
- ▶ Ideal for assembly, workshop or office applications



26526

Product ID	Description
26526	Sirrus Task Light LED w/ Swivel Head, 500mm Flex Arm & Mounting Clamp

### Sirrus Task Light LED High Intensity Fixed Focus with 500mm Flex Arm and Mounting Clamp

- ▶ 500mm flexible arm stays set in any position to provide direct light where needed
- ▶ High intensity energy saving LED
- ▶ Cool operating temperature
- ▶ Exceptionally long LED element life (minimum 20,000 hours)
- ▶ Ideal for assembly, workshop or office applications



26527

Product ID	Description
26527	Sirrus Task Light LED High Intensity Fixed Focus with 500mm Flex Arm and Mounting Clamp

### Sirrus LED Lamp w/ Aluminum Head, 500mm Flex Arm & Mounting Clamp

- ▶ 500mm flexible arm stays set in any position to provide direct light where needed
- ▶ High intensity energy saving LEDs
- ▶ Cool operating temperature
- ▶ Exceptionally long LED element life (minimum 20,000 hours)
- ▶ Ideal for assembly, workshop or office applications



26528

Product ID	Description
26528	Sirrus LED Lamp w/ Aluminum Head, 500mm Flex Arm & Mounting Clamp

### Sirrus Magnetic Base

- ▶ Magnetic Base for Sirrus LED task lights 26526, 26527, 26528
- ▶ Four screw holes provided to allow you to screw the task light to the base
- ▶ Allows for secure yet mobile placement on magnetic surfaces such as metal benches or cabinets



26520-MB

Product ID	Description
26520-MB	Sirrus Magnetic Base

### Machine Tool LED Task Light with Magnetic Base & 18" Flexible Arm

- ▶ Durable metal shade with black finish
- ▶ 24 high intensity energy saving LEDs
- ▶ Cool operating temperature
- ▶ Exceptionally long LED element life (minimum 20,000 hours)
- ▶ Strong magnetic base
- ▶ Flexible Arm for precise positioning



26530-LED

Product ID	Description
26530-LED	Machine Tool LED Task Light with Magnetic Base & 18" Flexible Arm

### Machine Tool LED Task Light Compact with 18" Flexible Arm

- ▶ Durable and compact lamp shade with black exterior
- ▶ 10 high intensity energy saving LEDs
- ▶ Cool operating temperature
- ▶ Exceptionally long LED element life (minimum 20,000 hours)
- ▶ Flexible Arm for precise positioning



26531-LED

Product ID	Description
26531-LED	Machine Tool LED Task Light Compact with 18" Flexible Arm

### Machine Tool LED Task Light Domed with 36" Flexible Arm

- ▶ Durable and compact lamp shade with black exterior
- ▶ 10 high intensity energy saving LEDs
- ▶ Cool operating temperature
- ▶ Exceptionally long LED element life (minimum 20,000 hours)
- ▶ Flexible Arm for precise positioning

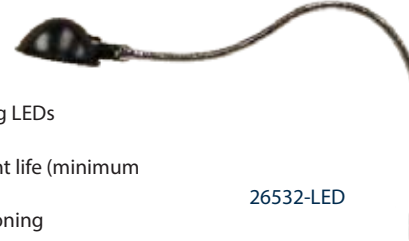

26532-LED

Product ID	Description
26532-LED	Machine Tool LED Task Light Domed with 36" Flexible Arm

### Machine Tool LED Task Light Domed with 23" Flexible Arm

- ▶ Durable and compact lamp shade with black exterior
- ▶ 10 high intensity energy saving LEDs
- ▶ Cool operating temperature
- ▶ Exceptionally long LED element life (minimum 20,000 hours)
- ▶ Flexible Arm for precise positioning



26533-LED

Product ID	Description
26533-LED	Machine Tool LED Task Light Domed with 23" Flexible Arm

### Ceramic Alignment Screwdrivers

- ▶ Anti Static, non magnetic, non inductive heat resistant ceramic tips
- ▶ Heat resistant up to 1292°F (700°C)
- ▶ Blades made from Zirconia ceramic
- ▶ Outlasts metal or plastic tip tools
- ▶ No eddy current loss in high frequency



13225

Product ID	Description	Blade	Tip Size
13220	Ceramic Alignment Screwdriver	Phillips	PH1.7
13221	Ceramic Alignment Screwdriver	Slotted	1.3 mm
13222	Ceramic Alignment Screwdriver	Slotted	2.6mm
13224	Ceramic Alignment Screwdriver	Slotted	0.9mm
13225	Ceramic Alignment Screwdriver	Slotted	1.8mm
13230	Ceramic Alignment Screwdriver 4-in-1	Phillips & Slotted	Phillips 0 & 1.7 Slotted 1.8 & 0.9mm

### Ceramic Alignment Screwdriver - 6-Piece Set

- ▶ Anti Static, non magnetic, non inductive heat resistant ceramic tips
- ▶ Heat resistant up to 1292°F (700°C)
- ▶ Blades made from Zirconia ceramic
- ▶ Outlasts metal or plastic tip tools
- ▶ No eddy current loss in high frequency



13231

Product ID	Description
13231	Ceramic Alignment Screwdriver - 6-Piece Set

### 9-Piece Anti-Static Alignment Tool Kit

- ▶ Anti-Static
- ▶ Designed for adjusting and aligning conventional components
- ▶ Includes 9 popular alignment tools



13016

Product ID	Description
13016	9-Piece Anti-Static Alignment Tool Kit

### Precision Screwdriver - 8-Piece Set

- ▶ Ergonomically designed handle with swivel head cap for precise control and comfort
- ▶ Two component handle provides soft touch and non slip surface and is oil and solvent resistant
- ▶ Blade made from high grade alloy steel
- ▶ Supplied in a handy plastic case for secure storage



13715

Product ID	Description
13715	Precision Screwdriver - 8-Piece Set

### Precision Screwdriver - 7-Piece Set

- ▶ Chrome Vanadium steel with satin finish and black tips
- ▶ Duplex Component handle is designed for rapid rotation and control
- ▶ Fast turning swivel caps
- ▶ Imprinted sizes on handle for easy selection
- ▶ 50mm Blade Length



13940

Product ID	Description
13940	Precision Screwdriver - 7-Piece Set

### Aven Precision Screwdrivers

- ▶ Precisely machined hardened black tips for durability and exact fit
- ▶ Screwdriver blades manufactured from chrome-molybdenum steel for extra strength
- ▶ Ergonomically designed bi-component handle with swivel cap for extra comfort and grip

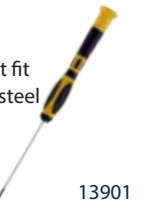

13901

Product ID	Description	Blade	Size	Length	Overall Length
13901	Precision Screwdriver	Slotted	1.6mm	50mm	150mm
13902	Precision Screwdriver	Slotted	2.0mm	50mm	150mm
13903	Precision Screwdriver	Slotted	2.4mm	50mm	150mm
13904	Precision Screwdriver	Slotted	3.0mm	50mm	150mm
13906	Precision Screwdriver	Slotted	3.0mm	100mm	200mm
13910	Precision Screwdriver	Phillips	No. 000	50mm	150mm
13911	Precision Screwdriver	Phillips	No. 00	50mm	150mm
13913	Precision Screwdriver	Phillips	No. 1	50mm	150mm
13915	Precision Screwdriver	Phillips	No. 1	100mm	200mm
13921	Precision Screwdriver	Torx	T6	50mm	150mm
13923	Precision Screwdriver	Torx	T8	50mm	150mm
13930	Precision Nutdriver	-	M3.0	72mm	172mm
13932	Precision Nutdriver	-	M4.0	72mm	172mm
13933	Precision Nutdriver	-	M4.5	72mm	172mm
13935	Precision Nutdriver	-	M5.5	72mm	172mm

### Precision Screwdriver - 6-Piece Set

- ▶ Screwdriver features Rotative Caps
- ▶ Two-component construction for soft touch and non-slip surface
- ▶ Environmentally friendly and recyclable materials
- ▶ Heat treated high grade alloy steel blades with blackened tips



13722

Product ID	Description
13722	Precision Screwdriver - 6-Piece Set

### 8 Piece Reversible Screwdriver Set

- ▶ Neo Microtip screwdriver handle features rotating cap
- ▶ Two-component construction for soft touch and non-slip surface
- ▶ Made from environmentally friendly and recyclable materials
- ▶ Heat treated high grade alloy steel blades with blackened tips



13941

Product ID	Description
13722	Precision Screwdriver - 6-Piece Set

Register online to receive updates on the newest products and for the latest specials from Aven.



# Hand Tools

## Stainless Steel Wrenches, Cutters & Pliers

### Adjustable Wrench - Stainless Steel

- ▶ Manufactured from 304 series stainless steel
- ▶ Mirror polished to provide excellent rust resistance
- ▶ Handle hole for tethering, hanging or storage
- ▶ Can be autoclaved to temperatures up to 250 degrees Fahrenheit



21190-6

Product ID	Description
21190-6	Adjustable Wrench 6" Stainless Steel
21190-8	Adjustable Wrench 8" Stainless Steel
21190-10	Adjustable Wrench 10" Stainless Steel
21190-12	Adjustable Wrench 12" Stainless Steel

### Adjustable Wrench - Stainless Steel w/ PVC Grip

- ▶ Manufactured from 304 series stainless steel
- ▶ Mirror polished to provide excellent rust resistance
- ▶ Cushion-grip handle
- ▶ Handle hole for tethering, hanging or storage



21190-10G

Product ID	Description
21190-6G	Adjustable Wrench 6" w/PVC Grip
21190-8G	Adjustable Wrench 8" w/PVC Grip
21190-10G	Adjustable Wrench 10" w/PVC Grip
21190-12G	Adjustable Wrench 12" w/PVC Grip

### Combination Wrench - Stainless Steel

- ▶ Manufactured from 304 series stainless steel
- ▶ Can be autoclaved to temperatures up to 250 degrees Fahrenheit
- ▶ Rust resistant, can help eliminate risk of ferrous contamination



21187-0516

Product ID	Description
21187-0516	Combination Wrench Stainless Steel 5/16"
21187-0308	Combination Wrench Stainless Steel 3/8"
21187-0716	Combination Wrench Stainless Steel 7/16"
21187-0102	Combination Wrench Stainless Steel 1/2"
21187-0916	Combination Wrench Stainless Steel 9/16"
21187-0508	Combination Wrench Stainless Steel 5/8"

### Combination Wrench - Stainless Steel - 6-Piece Set

- ▶ Made from 304 series stainless steel
- ▶ Can be autoclaved to temperatures up to 250 degrees Fahrenheit
- ▶ Rust resistant, can help eliminate risk of ferrous contamination
- ▶ Includes handy roll up plastic pouch



21187-105

Product ID	Description
21187-105	Combination Wrench Set Stainless Steel 6pc

### Diagonal Cutter - Stainless Steel 6"

- ▶ Manufactured from 400 series stainless steel
- ▶ Mirror polished to provide excellent rust resistance
- ▶ Oval head designed for greater access in confined spaces
- ▶ Beveled cutting edge is hardened for long lasting performance
- ▶ Can be autoclaved to temperatures up to 250 degrees Fahrenheit



10355

Product ID	Description
10355	Diagonal Cutter - Stainless Steel 6"

### Diagonal Cutter w/Comfort Grip Handles 6"

- ▶ Manufactured from 400 series stainless steel
- ▶ Mirror polished to provide excellent rust resistance
- ▶ Oval head designed for greater access in confined spaces
- ▶ Beveled cutting edge is hardened for long lasting performance
- ▶ Ergonomically designed grips for extra comfort



10355-ER

Product ID	Description
10355-ER	Diagonal Cutter w/Comfort Grip Handles 6"

### Diagonal Cutter "High Leverage" Stainless Steel 7"

- ▶ Manufactured from 400 series stainless steel
- ▶ Mirror polished to provide excellent rust resistance
- ▶ Provides more cutting power than general purpose pliers
- ▶ Beveled cutting edge is hardened for long lasting performance
- ▶ Can be autoclaved to temperatures up to 250 degrees Fahrenheit



10356

Product ID	Description
10356	Diagonal Cutter "High Leverage" Stainless Steel 7"

### Flat Nose Parallel Action Pliers 6.75"

- ▶ Serrated Jaws with V-Slot for holding wire
- ▶ Grip remains consistently parallel along length of jaw when open or closed
- ▶ Compound lever action with no spring
- ▶ Built-in wire cutter cuts soft wire up to 4mm (0.16")



10766

Product ID	Description
10766	Flat Nose Parallel Action Pliers 6.75"

### Groove Joint Pliers Stainless Steel 9.5"

- ▶ Manufactured from 400 series stainless steel
- ▶ Mirror polished to provide excellent rust resistance
- ▶ Slip-resistant tongue and groove design used for grasping and turning
- ▶ Serrated jaws with four adjustable positions
- ▶ Can be autoclaved to temperatures up to 250 degrees Fahrenheit



10365

Product ID	Description
10365	Groove Joint Pliers Stainless Steel 9.5"

# Hand Tools

## Stainless Steel Pliers

### Combination Pliers Stainless Steel 8"

- ▶ Manufactured from 400 series stainless steel
- ▶ Mirror polished to provide excellent rust resistance
- ▶ Tapered head design allows for greater access in confined spaces
- ▶ Designed for gripping and turning round objects such as pipes, rods and pins
- ▶ Serrated jaws with machined gripping teeth and wire cutter



10351

Product ID	Description
10351	Combination Pliers Stainless Steel 8"

### Combination Pliers w/Plastic Grips 8"

- ▶ Manufactured from 400 series stainless steel
- ▶ Mirror polished to provide excellent rust resistance
- ▶ Tapered head design allows for greater access in confined spaces
- ▶ Designed for gripping and turning round objects such as pipes, rods and pins
- ▶ Serrated jaws with machined gripping teeth and wire cutter



10351-P

Product ID	Description
10351-P	Combination Pliers w/Plastic Handles 8"

### Long Nose Pliers Stainless Steel 6"

- ▶ Manufactured from 400 series stainless steel
- ▶ Mirror polished to provide excellent rust resistance
- ▶ Length and slim design are ideal for tight spaces
- ▶ Serrated jaws with machined gripping teeth and wire cutter



10360

Product ID	Description
10360	Long Nose Pliers Stainless Steel 6"

### Long Nose Pliers w/Comfort Grip Handles 6"

- ▶ Manufactured from 400 series stainless steel
- ▶ Mirror polished to provide excellent rust resistance
- ▶ Length and slim design are ideal for tight spaces
- ▶ Ergonomically designed grips for extra comfort



10360-ER

Product ID	Description
10360-ER	Long Nose Pliers w/Comfort Grip Handles 6"

### Pliers Set Stainless Steel

- ▶ Mirror polished stainless steel provides excellent corrosion resistance
- ▶ Packaged in a leatherette roll-up pouch
- ▶ Set includes: 6" long-nose pliers, 6" slip-joint pliers, 6" wire-cutting pliers, 9-1/2" groove-joint pliers with flat jaws, and an 8" combination pliers



10381

Product ID	Description
10381	Pliers Set Stainless Steel



### Slip Joint Pliers Stainless Steel 6.5"

- ▶ Manufactured from 400 series stainless steel
- ▶ Mirror polished to provide excellent rust resistance
- ▶ All purpose pliers with serrated jaws, built-in wire cutter and pipe grip



10370

Product ID	Description
10370	Slip Joint Pliers Stainless Steel 6.5"

### Slip Joint Pliers w/Plastic Grips 6.5"

- ▶ Manufactured from 400 series stainless steel
- ▶ Mirror polished to provide excellent rust resistance
- ▶ All purpose pliers with serrated jaws, built-in wire cutter and pipe grip
- ▶ Plastic grips provide extra comfort



10370-P

Product ID	Description
10370-P	Slip Joint Pliers Stainless Steel 6.5"

### Locking Pliers Stainless Steel 7"

- ▶ Body and springs made from 304 non-magnetic stainless steel
- ▶ Jaws are made from 420-series stainless steel
- ▶ Fully polished to provide excellent rust resistance
- ▶ Smooth gliding locking mechanism enables easy one-handed operation
- ▶ Trigger release handles and easy turning pressure adjusting screw



10375

Product ID	Description
10375	Locking Pliers Stainless Steel 7"

### Locking Pliers Stainless Steel 9"

- ▶ Body and springs made from 304 non-magnetic stainless steel
- ▶ Jaws are made from 420-series stainless steel
- ▶ Fully polished to provide excellent rust resistance
- ▶ Smooth gliding locking mechanism enables easy one-handed operation



10376

Product ID	Description
10376	Locking Pliers Stainless Steel 9"

### Locking Pliers, Long Nose, Stainless Steel 6"

- ▶ Fully polished stainless steel provides excellent corrosion resistance
- ▶ Smooth gliding locking mechanism enables easy one-handed operation
- ▶ Long thin nose is ideal for accessing tight spaces
- ▶ Trigger release handles and easy turning pressure adjusting screw



10377

Product ID	Description
10377	Locking Pliers, Long Nose, Stainless Steel 6"



### Crimping Tool for Wire Ferrules

- ▶ For use with 22 to 6 AWG wire
- ▶ Replaceable dies
- ▶ Built in ratchet applies correct pressure to ensure a complete crimp
- ▶ Durable steel construction and hardened dies to ensure reliability and longevity
- ▶ ABS grips make this tool comfortable and easy to use



10178

Product ID	Description
10178	Crimping Tool for Wire Ferrules 12 to 22 AWG
10179	Crimping Tool for Wire Ferrules 6 to 10 AWG

### 2-in-1 Combination Scissor

- ▶ Easily trim materials such as nylon fiber, cabtire cord, Kevlar etc.
- ▶ Gives you a fine flush cut
- ▶ Notched blades prevent the material to be from slipping
- ▶ U-types notches on the blade allows you to hold items such as copper wire, cabtire or insulated cords etc. firmly in place
- ▶ Stainless Steel with blade hardness of HRC 54



11080

Product ID	Description
11080	2-in-1 Combination Scissor

### 2-in-1 Heavy-Duty Combination Scissor

- ▶ Easily trim materials such as nylon fiber, cabtire cord, Kevlar etc.
- ▶ 3mm thick blade gives you a fine flush cut
- ▶ Notched blades prevent the material to be trimmed from slipping
- ▶ U-types notches on the blade allows you to hold items such as copper wire, cabtire or insulated cords etc. firmly in place
- ▶ Stainless Steel with blade hardness of HRC 56-60



11081

Product ID	Description
11081	2-in-1 Heavy-Duty Combination Scissor

### 5" Electrician Scissor

- ▶ Fully polished stainless steel provides excellent corrosion resistance
- ▶ Scraper and file on back edge of the blade
- ▶ Notched to strip 23 to 19 AWG wire



11012

Product ID	Description
11012	5" Electrician Scissor

## Hand Tools

### Crimping Tools & Scissors

#### 4-1/2" Slim Blade Straight Scissor

- ▶ Fully polished stainless steel provides excellent corrosion resistance
- ▶ Precision scissor for cutting fine wire and general use
- ▶ 1-1/4" durable stainless steel blade



11014

Product ID	Description
11014	4-1/2" Slim Blade Straight Scissor

#### 4-1/2" Precision Scissor

- ▶ Fully polished stainless steel provides excellent corrosion resistance
- ▶ Fine beaks for precise and delicate work
- ▶ 1-3/8" durable stainless steel blade



11016

Product ID	Description
11016	4-1/2" Precision Scissor

#### 7" All Purpose Standard Scissor

- ▶ Fully polished stainless steel provides excellent corrosion resistance
- ▶ 3-1/4" durable stainless steel blade

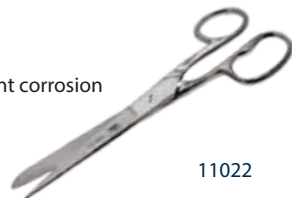

11022

Product ID	Description
11022	7" All Purpose Standard Scissor

#### 8" All Purpose Standard Scissor

- ▶ Fully polished stainless steel provides excellent corrosion resistance
- ▶ 3-3/4" durable stainless steel blade

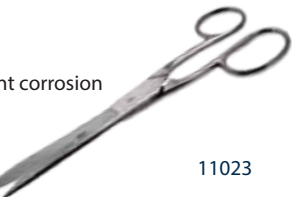

11023

Product ID	Description
11023	8" All Purpose Standard Scissor

Register online to receive updates on the newest products and for the latest specials from Aven.

## Hand Tools

### Hemostats & Probes

#### Probe Straight Needle Point

- ▶ Made from 400 series stainless steel
- ▶ Sharp tip for precision work around delicate circuits and components
- ▶ Eight sided handle to ensure grip and prevent rolling



20031

Product ID	Description
20031	Probe Straight Needle Point

#### Probe Bent Needle Point

- ▶ Made from 400 series stainless steel
- ▶ Sharp tip for precision work around delicate circuits and components
- ▶ Eight sided handle to ensure grip and prevent rolling



20032

Product ID	Description
20032	Probe Bent Needle Point - 90 degree bent point

#### Probe Curved Needle Point

- ▶ Made from 400 series stainless steel
- ▶ Sharp tip for precision work around delicate circuits and components
- ▶ Eight sided handle to ensure grip and prevent rolling



20034

Product ID	Description
20034	Probe Curved Needle Point

#### Probe Double Sided Scraper Bent Tips

- ▶ Made from 400 series stainless steel
- ▶ Sharp tip for precision work around delicate circuits and components



20035

Product ID	Description
20035	Probe Double Sided Scraper Bent Tips

#### Probe Double Sided Scraper Angled/Curved

- ▶ Made from 400 series stainless steel
- ▶ Sharp tip for precision work around delicate circuits and components



20037

Product ID	Description
20037	Probe Double Sided Scraper Angled/Curved

#### Probe Double End Bent/Curved

- ▶ Made from 400 series stainless steel
- ▶ Sharp tip for precision work around delicate circuits and components



20039

Product ID	Description
20039	Probe Double End Bent/Curved

#### Stainless Steel Probe 4-piece Set

- ▶ Made from 400 series stainless steel
- ▶ Sharp tip for precision work around delicate circuits and components
- ▶ Set of four contains: Straight, Bent, Curved and Angled Models



20210

Product ID	Description
20210	Stainless Steel Probe 4-piece Set



### Alligator Clamp

- ▶ Serrated jaws for secure grip
- ▶ Angled to provide maximum view
- ▶ Stainless steel construction
- ▶ Designed to securely retrieve and hold small parts



12201

Product ID	Description	Jaw Length	Opening
12201	Alligator Clamp 3.5"	0.5"	0.25"
12202	Alligator Clamp 5.5"	0.5"	0.25"

### Hemostat - Straight

- ▶ Manufactured from 400 series stainless steel
- ▶ Mirror polished to provide excellent corrosion resistance
- ▶ Serrated jaws hold objects firmly without cutting them
- ▶ Designed for intricate work in tight spaces
- ▶ Ratchet lock in handle allows varying gripping pressure



12001

Product ID	Description	Jaw Length
12001	Hemostat - Straight   3.5in	20mm
12015	Hemostat - Straight   5in	25.4mm
12011	Hemostat - Straight   5in w/Plastic Coated Handle	25.4mm
12017	Hemostat - Straight   6in	31.75mm
12013	Hemostat - Straight   6in w/Plastic Coated Handle	31.75mm
12019	Hemostat - Straight   8in	60mm
12021	Hemostat - Straight   16in	127mm
12030	Hemostat - Straight   18in	139mm
12032	Hemostat - Straight   24in	155mm

### Hemostat - Curved

- ▶ Manufactured from 400 series stainless steel
- ▶ Mirror polished to provide excellent corrosion resistance
- ▶ Serrated jaws hold objects firmly without cutting them
- ▶ Designed for intricate work in tight spaces
- ▶ Ratchet lock in handle allows varying gripping pressure



12002

Product ID	Description	Jaw Length
12002	Hemostat - Curved   3.5in	20mm
12016	Hemostat - Curved   5in	25.4mm
12012	Hemostat - Curved   5in w/Plastic Coated Handle	25.4mm
12018	Hemostat - Curved   6in	31.75mm
12014	Hemostat - Curved   6in w/Plastic Coated Handle	31.75mm
12020	Hemostat - Curved   8in	60mm
12022	Hemostat - Curved   16in	127mm
12031	Hemostat - Curved   18in	139mm
12033	Hemostat - Curved   24in	155mm

### Technik K-18 Grip-On Non-Roll Soft Handle Knife

- ▶ 5-inch comfortable soft grip handle
- ▶ Four jaw machined aluminum chuck for secure blade positioning
- ▶ Includes a super sharp #11 blade and clear plastic safety cap
- ▶ Ideal for cutting or trimming plastic, wood, paper, cloth and film

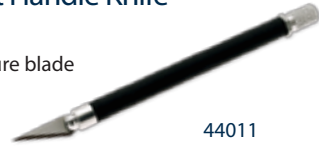

44011

Product ID	Description	Blade Size
44011	Technik K-18 Grip-On Non-Roll Soft Handle Knife	#11

### Technik K-1 Precision Light Duty Knife

- ▶ 4-3/4-inch aluminum handle
- ▶ 4-slot point chuck for easy blade release
- ▶ Includes a super sharp #11 blade and a high impact safety cap
- ▶ Ideal for precision cutting, forming and stripping of paper, plastic, wood, cloth and film
- ▶ Fits replacement blades #10, 11, 16, 17



44012

Product ID	Description	Blade Size
44012	Technik K-1 Precision Light Duty Knife	#11

### Technik K-2 Medium Duty Knife

- ▶ 4-3/4-inch aluminum handle
- ▶ 4-slot point chuck for easy blade release
- ▶ Includes a super sharp #22 blade and a high impact safety cap
- ▶ Ideal for precision cutting, trimming and stripping paper, plastic, wood, cloth and film
- ▶ Fits replacement blades #2, 18, 19, 22, 23, 24, 25, 26, 27, 28



44013

Product ID	Description	Blade Size
44013	Technik K-2 Medium Duty Knife	#22

### Technik K-5 Heavy Duty Knife

- ▶ 7/16-inch aluminum adapter
- ▶ 4-slot point chuck for easy blade release
- ▶ Includes a #19 sharp edge angled blade and a snug fitting plastic safety cap
- ▶ Ideal for precision cutting, trimming and stripping paper, plastic, and wood
- ▶ Fits replacement blades #2, 18, 19, 22, 23, 24, 25, 26, 27, 28



44014

Product ID	Description	Blade Size
44014	Technik K-5 Heavy Duty Knife	#19

### Technik K-8 Flat Handle Light Duty Knife

- ▶ Sleek long handle design with a sharp utility blade
- ▶ Both ends of the blade can be used for cutting
- ▶ Blade can be adjusted easily
- ▶ Ideal for cutting boxes, wood, leather and foam
- ▶ Fits replacement blades 44257, K-8 Replacement Blade (5/pk)



44015

Product ID	Description
44015	Technik K-8 Flat Handle Light Duty Knife

### Technik K-10 Plastic Snap Blade Knife

- ▶ 13-Point snap off blade in a strong plastic track
- ▶ Plastic auto-lock handle
- ▶ Ideal for home, office, or industrial use cutting paper, plastic, wood and other items
- ▶ Fits replacement blades 44256, K-10 Replacement Blade (100/pk)



44016

Product ID	Description
44016	Technik K-10 Plastic Snap Blade Knife

### Technik K-13 Heavy Duty Snap Blade Knife

- ▶ 7-Point deluxe snap off blade in a strong plastic track
- ▶ Plastic auto-lock handle
- ▶ Ideal for home, office, or industrial use cutting paper, plastic, wood and other items
- ▶ Fits replacement blades 44254, K-13 Replacement Blade (100/pk)



44017

Product ID	Description
44017	Technik K-13 Heavy Duty Snap Blade Knife

### Technik K-40 Pocket Clip Light Duty Utility Knife

- ▶ Multi-purpose precision knife is ideal for cutting and trimming
- ▶ Unique twist lock pocket clip safety cap
- ▶ Machined aluminum 4 jaw chuck for tight secure blade housing
- ▶ Comfortable ridged tapered plastic handle
- ▶ Fits replacement blades #10, 11, 16, 17
- ▶ Super sharp #11 blade



44018

Product ID	Description	Blade Size
44018	Technik K-40 Pocket Clip Light Duty Utility Knife	#11

### Technik Knife Set

- ▶ Contains K1, K2, K5 knife handles
- ▶ 13 assorted blades
- ▶ Includes a Teflon covered magnetic strip to help in holding the blades securely
- ▶ Organized in convenient plastic tray



44101

Product ID	Description
44101	Technik Knife Set

### Technik Deluxe Knife Set

- ▶ Contains K1, K2, K5 knife handles
- ▶ 13 assorted blades
- ▶ Includes a Teflon covered magnetic strip to help in holding the blades securely
- ▶ Securely organized in a deluxe wood box



44102

Product ID	Description
44102	Technik Deluxe Knife Set

### Scalpel Blade Handle Plastic #3

- ▶ #3 size handle is designed to fit blade styles #10, 11, 12, & 15
- ▶ Makes loading blades easy
- ▶ Perfectly balanced and precision machined plastic
- ▶ Fluted finger grips



44030

Product ID	Description
44030	Scalpel Blade Handle Plastic #3

### Scalpel Blade Handle Stainless Steel #3

- ▶ #3 size handle is designed to fit blade styles #10, 11, 12, & 15
- ▶ Makes loading blades easy
- ▶ Perfectly balanced and precision machined stainless steel
- ▶ Fluted finger grips



44031

Product ID	Description
44031	Scalpel Blade Handle Stainless Steel #3

### Scalpel Blade Handle Plastic #4

- ▶ #4 size handle is specifically designed to fit #23 blade style
- ▶ Makes loading blades easy
- ▶ Perfectly balanced and precision machined plastic
- ▶ Fluted finger grips



44032

Product ID	Description
44032	Scalpel Blade Handle Plastic #4

### Scalpel Blade Handle Stainless Steel #4

- ▶ #4 size handle is specifically designed to fit #23 blade style
- ▶ Makes loading blades easy
- ▶ Perfectly balanced and precision machined stainless steel
- ▶ Fluted finger grips



44033

Product ID	Description
44033	Scalpel Blade Handle Stainless Steel #4

### Scalpel Blades

- ▶ Made from surgical quality non-sterile .015" thick stainless steel
- ▶ Very sharp, precise and durable blade generally used for precision cutting in micro circuitry, photography, art, etc.
- ▶ Can be used with a plastic or stainless steel handle
- ▶ Contains two pieces per tube



44033

Product ID	Description	Blade Type
44041	Scalpel Blade #10	Curved cutting edge
44042	Scalpel Blade #11	Elongated triangular cutting edge
44043	Scalpel Blade #12	Small, pointed, crescent shaped cutting edge
44044	Scalpel Blade #15	Small curved cutting edge
44045	Scalpel Blade #23	Rounded "leaf shaped" cutting edge

### Replacement Blades



Product ID	Description	Product ID	Description
44201	No. 2 Blade (5/pk)	44216	No. 18 Blade (100/pk)
44202	No. 2 Blade (100/pk)	44217	No. 19 Blade (5/pk)
44203	No. 10 Blade (5/pk)	44218	No. 19 Blade (100/pk)
44204	No. 10 Blade (100/pk)	44221	No. 22 Blade (5/pk)
44205	No. 11 Blade (5/pk)	44222	No. 22 Blade (100/pk)
44205S	No. 11 Stainless Steel Blade (5/pk)	44223	No. 23 Blade (5/pk)
44206	No. 11 Blade (100/pk)	44224	No. 23 Blade (100/pk)
44206S	No. 11 Stainless Steel Blade (100/pk)	44225	No. 24 Blade (5/pk)
44211	No. 16 Blade (5/pk)	44226	No. 24 Blade (100/pk)
44212	No. 16 Blade (100/pk)	44227	No. 25 Blade (5/pk)
44213	No. 17 Blade (5/pk)	44228	No. 25 Blade (100/pk)
44214	No. 17 Blade (100/pk)	44229	No. 26 Blade (5/pk)
44215	No. 18 Blade (5/pk)	44230	No. 27 Blade (5/pk)
		44231	No. 28 Blade (5/pk)

### K-8, K-10 & K-13 Replacement Blades

- ▶ Snap off replacement blades
- ▶ Replacement blade for Technik K-8, Technik K-10, and Technik K-13 knives
- ▶ Ideal for home, office, or industrial use cutting paper, plastic, wood and other items

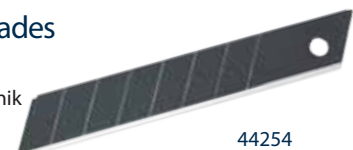

44254

Product ID	Description
44254	K-13 Replacement Blade (100/pk)
44256	K-10 Replacement Blade (100/pk)
44257	K-8 Replacement Blade (5/pk)

# Precision Cutters & Pliers

## Accu-Cut Oval Head Cutter

- ▶ This popular shape can be used for many applications
- ▶ ESD Safe Ergonomic Grips for superior comfort
- ▶ Robust oval head designed for durability



10821S

Product ID	Description	Cutting Edge	Capacity
10821S	Accu-Cut Oval Head Cutter	Semi-Flush	0.2-1.25mm
10821F	Accu-Cut Oval Head Cutter	Flush	0.15-1.25mm

## Accu-Cut Oval Relief Head Cutter

- ▶ This popular shape can be used for many applications
- ▶ Relieved head allows easier access in tight confined areas
- ▶ ESD Safe Ergonomic Grips for superior comfort
- ▶ Designed to be durable



10822F

Product ID	Description	Cutting Edge	Capacity
10822S	Accu-Cut Oval Relief Head Cutter	Semi-Flush	0.2-1.2mm
10822F	Accu-Cut Oval Relief Head Cutter	Flush	0.15-1.1mm

## Accu-Cut Large Oval Head Cutter

- ▶ 25% larger than our standard oval head cutters
- ▶ Larger cutting capacity
- ▶ ESD Safe Ergonomic Grips for superior comfort
- ▶ Designed to be durable



10823S

Product ID	Description	Cutting Edge	Capacity
10823S	Accu-Cut Large Oval Head Cutter	Semi-Flush	0.2-1.5mm
10823F	Accu-Cut Large Oval Head Cutter	Flush	0.15-1.5mm
10823R	Accu-Cut Large Oval Head Cutter	Razor Flush®	0.15-1.3mm

Register online to receive updates on the newest products and for the latest specials from Aven.

## Accu-Cut XL Oval Head Cutter

- ▶ Extra large oval head for cutting heavy duty wire
- ▶ ESD Safe Ergonomic Grips for superior comfort
- ▶ Designed to be durable



10829S

Product ID	Description	Cutting Edge	Capacity
10829S	Accu-Cut XL Oval Head Cutter	Semi-Flush	0.4-2mm
10829F	Accu-Cut XL Oval Head Cutter	Flush	0.3-2mm

## Accu-Cut Mini Oval Head Cutter

- ▶ Miniature oval head for fine cutting work
- ▶ ESD Safe Ergonomic Grips for superior comfort
- ▶ Designed to be durable



10827F

Product ID	Description	Cutting Edge	Capacity
10827S	Accu-Cut Mini Oval Head Cutter	Semi-Flush	0.2-1.25mm
10827F	Accu-Cut Mini Oval Head Cutter	Flush	0.1-0.9mm

## Accu-Cut Tapered Head Cutter

- ▶ Pointed head allows for increased access in tight areas
- ▶ ESD Safe Ergonomic Grips for superior comfort
- ▶ Designed to be durable



10825S

Product ID	Description	Cutting Edge	Capacity
10825S	Accu-Cut Tapered Head Cutter	Semi-Flush	0.2-1.25mm
10825F	Accu-Cut Tapered Head Cutter	Flush	0.15-1.25mm

## Accu-Cut Tapered Relief Head Cutter

- ▶ Pointed head with relief allows for increased access in tight areas
- ▶ ESD Safe Ergonomic Grips for superior comfort
- ▶ Designed to be durable



10826F

Product ID	Description	Cutting Edge	Capacity
10826S	Accu-Cut Tapered Relief Head Cutter	Semi-Flush	0.2-1.15mm
10826F	Accu-Cut Tapered Relief Head Cutter	Flush	0.1-1.05mm

## Accu-Cut Mini Tapered Relief Cutter

- ▶ Miniature tapered head with relief for exceptionally fine cutting work
- ▶ ESD Safe Ergonomic Grips for superior comfort
- ▶ Designed to be durable



10828S

Product ID	Description	Cutting Edge	Capacity
10828S	Accu-Cut Mini Tapered Relief Cutter	Semi-Flush	0.2-1.1mm
10828F	Accu-Cut Mini Tapered Relief Cutter	Flush	0.1-1mm

# Precision Cutters & Pliers

## Technik Stainless Steel Pliers and Cutters

### Oval Head Cutter 114mm (4.5")

- ▶ Manufactured from 400 series stainless steel
- ▶ Induction hardened jaws
- ▶ Dual leaf springs
- ▶ ESD Safe cushioned grips
- ▶ Box Joint construction provides superior jaw alignment and durability



10321

Product ID	Description	Cutting Edge	Capacity
10321*	Oval Head Cutter 114mm (4.5")	Semi-Flush	0.2-1.25mm
10323	Oval Head Cutter 114mm (4.5")	Flush	0.15-1.25mm

### Oval Head Cutter Large 127mm (5")

- ▶ Manufactured from 400 series stainless steel
- ▶ Induction hardened jaws
- ▶ Dual leaf springs
- ▶ ESD Safe cushioned grips
- ▶ Box Joint construction provides superior jaw alignment and durability



10322

Product ID	Description	Cutting Edge	Capacity
10322	Oval Head Cutter Large 127mm (5")	Semi-Flush	0.2-1.5mm
10324	Oval Head Cutter Large 127mm (5")	Flush	0.15-1.5mm

### Mini Oval Head Cutter 110mm (4.3")

- ▶ Manufactured from 400 series stainless steel
- ▶ Induction hardened jaws
- ▶ Dual leaf springs
- ▶ ESD Safe cushioned grips
- ▶ Box Joint construction provides superior jaw alignment and durability



10332

Product ID	Description	Cutting Edge	Capacity
10332	Mini Oval Head Cutter 110mm (4.3")	Flush	0.1-1.25mm

### Tapered Head Cutter 114mm (4.5")

- ▶ Manufactured from 400 series stainless steel
- ▶ Induction hardened jaws
- ▶ Dual leaf springs
- ▶ ESD Safe cushioned grips
- ▶ Box Joint construction provides superior jaw alignment and durability



10325

Product ID	Description	Cutting Edge	Capacity
10325	Tapered Head Cutter 114mm (4.5")	Semi-Flush	0.2-1.25mm
10326	Tapered Head Cutter 114mm (4.5")	Flush	0.15-1.25mm

### Tapered Relief Cutter 114mm (4.5")

- ▶ Manufactured from 400 series stainless steel
- ▶ Induction hardened jaws
- ▶ Dual leaf springs
- ▶ ESD Safe cushioned grips
- ▶ Box Joint construction provides superior jaw alignment and durability



10329

Product ID	Description	Cutting Edge	Capacity
10329	Tapered Relief Cutter 114mm (4.5")	Flush	0.1-1.05mm

NOTE: Product ID's with \* included in 10600A Precision Stainless Steel Pliers Set.

### Mini Tapered Head Cutter 110mm (4.3")

- ▶ Manufactured from 400 series stainless steel
- ▶ Induction hardened jaws
- ▶ Dual leaf springs
- ▶ ESD Safe cushioned grips
- ▶ Box Joint construction provides superior jaw alignment and durability



10331

Product ID	Description	Cutting Edge	Capacity
10331	Mini Tapered Head Cutter 110mm (4.3")	Flush	0.1-1.25mm

### Tip Cutter 114mm (4.5")

- ▶ Manufactured from 400 series stainless steel
- ▶ Induction hardened jaws
- ▶ Dual leaf springs
- ▶ ESD Safe cushioned grips
- ▶ Box Joint construction provides superior jaw alignment and durability
- ▶ Tip cutter with deep relief and low profile



10330

Product ID	Description	Cutting Edge	Capacity
10330	Tip Cutter 114mm (4.5")	Flush	0.1-1.05mm

### End Cutter 114mm (4.5")

- ▶ Manufactured from 400 series stainless steel
- ▶ Induction hardened jaws
- ▶ Dual leaf springs
- ▶ ESD Safe cushioned grips
- ▶ Box Joint construction provides superior jaw alignment and durability
- ▶ Designed to cut close to the surface leaving smooth surface behind



10327

Product ID	Description	Cutting Edge	Capacity
10327*	End Cutter 114mm (4.5")	Semi-Flush	0.2-1.25mm

### Oblique Head Cutter 114mm (4.5")

- ▶ Manufactured from 400 series stainless steel
- ▶ Induction hardened jaws
- ▶ Dual leaf springs
- ▶ ESD Safe cushioned grips
- ▶ Box Joint construction provides superior jaw alignment and durability
- ▶ Designed to cut close to the surface
- ▶ Oblique tip can be used for fine wire cutting



10328

Product ID	Description	Cutting Edge	Capacity
10328	Oblique Head Cutter 114mm (4.5")	Semi-Flush	0.2-1.25mm

### Long Nose Pliers w/cutter 120.5mm (4.75")

- ▶ Manufactured from 400 series stainless steel
- ▶ Induction hardened jaws
- ▶ Dual leaf springs
- ▶ ESD Safe cushioned grips
- ▶ Box Joint construction provides superior jaw alignment and durability



10315

Product ID	Description	Jaw Length	Tip Width	Jaw Type
10315*	Long Nose Pliers w/cutter	26.4mm	1.8mm	Serrated





# Precision Cutters & Pliers

Technik Stainless Steel Pliers and Cutters

## Chain Nose Pliers 114mm (4.5")

- ▶ Manufactured from 400 series stainless steel
- ▶ Induction hardened jaws
- ▶ Dual leaf springs
- ▶ ESD Safe cushioned grips
- ▶ Box Joint construction provides superior jaw alignment and durability



10301

Product ID	Description	Jaw Length	Tip Width	Jaw Type
10301*	Chain Nose Pliers 114mm (4.5")	23.6mm	1.8mm	Smooth
10307	Chain Nose Pliers 114mm (4.5")	23.6mm	1.8mm	Serrated

## Chain Nose Pliers 127mm (5")

- ▶ Manufactured from 400 series stainless steel
- ▶ Induction hardened jaws
- ▶ Dual leaf springs
- ▶ ESD Safe cushioned grips
- ▶ Box Joint construction provides superior jaw alignment and durability



10302

Product ID	Description	Jaw Length	Tip Width	Jaw Type
10302	Chain Nose Pliers 127mm (5")	26.6mm	1.8mm	Smooth
10308	Chain Nose Pliers 127mm (5")	26.6mm	1.8mm	Serrated
10311	Chain Nose Pliers 127mm (5")	37.4mm	1.8mm	Smooth
10311S	Chain Nose Pliers 127mm (5")	37.4mm	1.8mm	Serrated

## Chain Nose Pliers 152mm (6")

- ▶ Manufactured from 400 series stainless steel
- ▶ Induction hardened jaws
- ▶ Dual leaf springs
- ▶ ESD Safe cushioned grips
- ▶ Box Joint construction provides superior jaw alignment and durability



10333

Product ID	Description	Jaw Length	Tip Width	Jaw Type
10333	Chain Nose Pliers 152mm (6")	38.8mm	2mm	Serrated

## Flat Nose Pliers 114mm - 152mm (4.5" - 6")

- ▶ Manufactured from 400 series stainless steel
- ▶ Induction hardened jaws
- ▶ Dual leaf springs
- ▶ ESD Safe cushioned grips
- ▶ Box Joint construction provides superior jaw alignment and durability



10335

Product ID	Description	Jaw Length	Tip Width	Jaw Type
10303*	Flat Nose Pliers 114mm (4.5")	23.6mm	3.2mm	Smooth
10304	Flat Nose Pliers 127mm (5")	29.9mm	5.87mm	Smooth
10335	Flat Nose Pliers 152mm (6")	42mm	5.3mm	Smooth

## Round Nose Pliers 114mm - 127mm (4.5 - 5")

- ▶ Manufactured from 400 series stainless steel
- ▶ Induction hardened jaws
- ▶ Dual leaf springs
- ▶ ESD Safe cushioned grips
- ▶ Box Joint construction provides superior jaw alignment and durability



10305

Product ID	Description	Jaw Length	Tip Width	Jaw Type
10305	Round Nose Pliers 114mm (4.5")	21.3mm	1.14mm	Smooth
10306	Round Nose Pliers 127mm (5")	23.6mm	1.14mm	Smooth

## Bent Nose Pliers 114mm (4.5")

- ▶ Manufactured from 400 series stainless steel
- ▶ Induction hardened jaws
- ▶ Dual leaf springs
- ▶ ESD Safe cushioned grips
- ▶ Box Joint construction provides superior jaw alignment and durability



10310

Product ID	Description	Jaw Length	Tip Width	Jaw Type
10309	Bent Nose Pliers 114mm (4.5")	22.8mm	1.5mm	Smooth
10310	Bent Nose Pliers 114mm (4.5")	22.8mm	1.5mm	Serrated

## Bent Nose Pliers 152mm (6")

- ▶ Manufactured from 400 series stainless steel
- ▶ Induction hardened jaws
- ▶ Dual leaf springs
- ▶ ESD Safe cushioned grips
- ▶ Box Joint construction provides superior jaw alignment and durability



10313

Product ID	Description	Jaw Length	Tip Width	Jaw Type
10313	Bent Nose Pliers 152mm (6")	40.6mm	2mm	Smooth

## Needle Nose Pliers 146mm (5.75")

- ▶ Manufactured from 400 series stainless steel
- ▶ Induction hardened jaws
- ▶ Dual leaf springs
- ▶ ESD Safe cushioned grips
- ▶ Box Joint construction provides superior jaw alignment and durability



10314

Product ID	Description	Jaw Length	Tip Width	Jaw Type
10314*	Needle Nose Pliers	49mm	1.5mm	Serrated

## Needle Nose Pliers Curved 152mm (6")

- ▶ Manufactured from 400 series stainless steel
- ▶ Induction hardened jaws
- ▶ Dual leaf springs
- ▶ ESD Safe cushioned grips
- ▶ Box Joint construction provides superior jaw alignment and durability



10953

Product ID	Description	Jaw Length	Tip Width	Jaw Type
10953	Needle Nose Pliers Curved	31.2mm	1.3mm	Serrated

## Precision Stainless Steel Pliers Set 6pc

- ▶ Induction hardened jaws
- ▶ Dual leaf springs
- ▶ ESD Safe cushioned grips
- ▶ Manufactured from 400 series stainless steel
- ▶ Box Joint construction provides superior jaw alignment and durability
- ▶ Set includes: Technik Stainless Steel Pliers & Cutters - 10301, 10303, 10314, 10315, 10321, 10327
- ▶ Tools come with a handy leatherette pouch



10600A

Product ID	Description
10600A	Needle Nose Pliers Curved

NOTE: Product ID's with \* included in 10600A Precision Stainless Steel Pliers Set.

# Precision Cutters & Pliers

Niptec Cutters & Parallel Action Pliers



## Niptec TR 5000 Cutter

- ▶ Durable 5mm thick blades
- ▶ Compact ergonomic design
- ▶ Semi-flush cutting edge
- ▶ For use on copper wire up to 12 AWG
- ▶ ESD Safe grips make tool comfortable and easy to use



10501

Product ID	Description	Cutting Edge
10501	Niptec TR 5000 Cutter	Semi-Flush

## Niptec TR 5000PG Cutter

- ▶ Durable 5mm thick blades
- ▶ Compact ergonomic design
- ▶ Flush cutting edge
- ▶ For use on copper wire up to 16 AWG
- ▶ ESD Safe grips make tool comfortable and easy to use



10503

Product ID	Description	Cutting Edge
10503	Niptec TR 5000PG Cutter	Flush

## Niptec TR 25 Cutter

- ▶ For use on copper wire up to 18 AWG
- ▶ ESD Safe grips make tool comfortable and easy to use
- ▶ Compact ergonomic design
- ▶ Flush cutting edge
- ▶ Narrow cutting head for access into dense areas



10521

Product ID	Description	Cutting Edge
10521	Niptec TR 25 Cutter	Flush

## Niptec TR 25-E Cutter

- ▶ For use on copper wire up to 18 AWG
- ▶ Blue non-slip grips make tool comfortable and easy to use
- ▶ Compact ergonomic design
- ▶ Flush cutting edge
- ▶ Narrow cutting head for access into dense areas



10521EC

Product ID	Description	Cutting Edge
10521EC	Niptec TR 25-E Cutter	Flush

## Niptec TR 20 50M Cutter

- ▶ ESD Safe grips make tool comfortable and easy to use
- ▶ Compact ergonomic design
- ▶ Flush cutting edge
- ▶ Small cutting head angled at 48° for access into tight places
- ▶ For use on copper wire up to 22 AWG



10525

Product ID	Description	Cutting Edge
10525	Niptec TR 20 50M Cutter	Flush

## Niptec TR 20 TM Cutter

- ▶ Compact ergonomic design
- ▶ Flush cutting edge
- ▶ For use on copper wire up to 22 AWG
- ▶ Designed specifically for cutting integrated circuit pins
- ▶ ESD Safe grips make tool comfortable and easy to use
- ▶ Narrow cutting head angled at 45° for access into dense areas



10526

Product ID	Description	Cutting Edge
10526	Niptec TR 20 TM Cutter	Flush

## Niptec TR 20M Cutter

- ▶ Compact ergonomic design
- ▶ ESD Safe grips make tool comfortable and easy to use
- ▶ For use on copper wire up to 20 AWG
- ▶ Small cutting head angled at 21° for access into tight places



10527B

Product ID	Description	Cutting Edge
10527B	Niptec TR 20M Cutter	Flush

## Pliers Parallel Action 5" Snipe Nose

- ▶ Grip remains consistently parallel along full length of jaw when open or closed
- ▶ Smooth, snipe profile jaws offer square vice-like grip
- ▶ Compound lever action with no spring
- ▶ Compact, ergonomic design
- ▶ Nickel-plated handles with jaws made of hardened steel



10753

Product ID	Description	Max Open	Jaw Length
10753	Pliers Parallel Action 5" Snipe Nose	10mm	25mm

## Flat Nose Pliers 8"

- ▶ Serrated Jaws with V-Slot for holding wire
- ▶ Grip remains consistently parallel along full length of jaw when open or closed
- ▶ Compound lever action with no spring
- ▶ Nickel-plated handles with jaws made of hardened steel



10756

Product ID	Description	Max Open	Jaw Length
10756	Flat Nose Pliers 8"	17mm	41mm

## Flat Nose Pliers w/Wire Cutters 5"

- ▶ Serrated Jaws with V-Slot for holding wire
- ▶ Compound lever action with no spring
- ▶ Nickel-plated handles with jaws made of hardened steel
- ▶ Built-in wire cutter cuts soft wire up to 2.5mm (0.1")
- ▶ Grip remains consistently parallel along full length of jaw when open or closed



10761

Product ID	Description	Max Open	Jaw Length
10761	Flat Nose Pliers 8"	17mm	35mm

## Flat Nose Pliers w/Wire Cutters 8"

- ▶ Serrated Jaws with V-Slot for holding wire
- ▶ Grip remains consistently parallel along full length of jaw when open or closed
- ▶ Compound lever action with no spring
- ▶ Cushion-grip handles with jaws made of hardened steel
- ▶ Built-in wire cutter cuts soft wire up to 6mm (0.24")



10764

Product ID	Description	Max Open	Jaw Length
10764	Flat Nose Pliers w/Wire Cutters 8"	17mm	41mm

## Diagonal Cutter Compound Action 6.5"

- ▶ Compound lever action handles give you more power for cutting and gripping
- ▶ Compound lever action handles require less force when cutting
- ▶ Durable, semi-flush cutting jaw will cut piano wire up to 2mm
- ▶ Ergonomic design provides extra comfort and ease in use

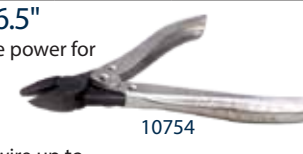

10754

Product ID	Description	Max Open	Jaw Length
10754	Diagonal Cutter Compound Action 6.5"	17mm	41mm



# Tweezers

Choosing the Correct Tweezer

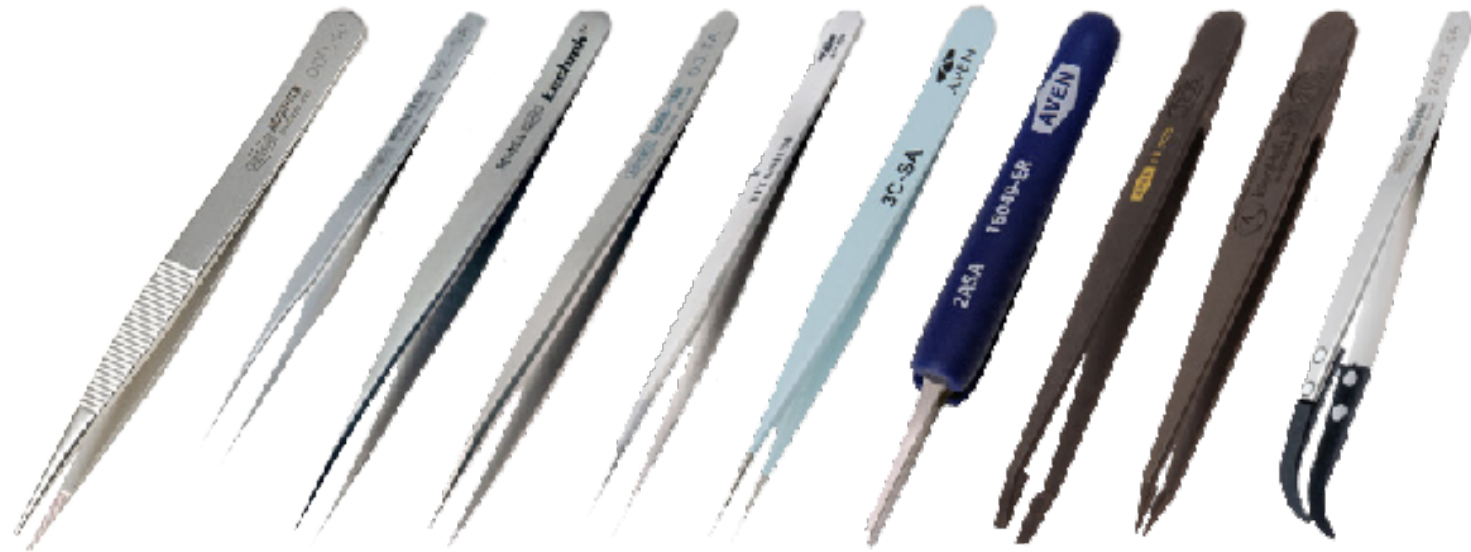

Aven offers a wide variety of tweezers to meet a broad range of applications and 2 different quality grades.

In order to choose the best tool for your application:

1. Determine the type of points best suited for your application.
2. Refer to the material guide below and select the correct material for your application.
3. Determine the quality level required for your application if applicable. (Table 1)

Special Coatings (Available on non-magnetic stainless steel only)

TE - Teflon Superior anti-scratch, non-stick material. Acid resistant. 400°F/200°C

EP - Epoxy Good electrical insulation and resistance to chemicals. Antiglare. 300°F/150°C

\* To order tweezers with above mentioned coatings, call Aven for price and delivery time.

Material Selection Guide (Table 2)			
Material	Tip Hardness	Magnetism	Corrosion Resistance
Titanium	Excellent	Never	Excellent
Carbon steel	Excellent	Yes	Low
Stainless Steel	Very Good	Some	Good
Stainless Steel, Anti-magnetic, Anti-acid	Good	None to very little	Excellent, Resists Acids
Carbon Composite	Soft	None	Non-corrosive

**Titanium:** Titanium tweezers are excellent for use in the silicon chip industry, as they do not shed particles like the stainless steel. When it is determined that microscopic particles are a detriment when handling abrasive parts we recommend using titanium tweezers. In addition since titanium tweezers are 100% non magnetic, they are extremely useful when working with magnetic materials or when working in a magnetic field. Titanium is lightweight and a high strength material.

**Ceramic:** ESD Safe, non magnetic. Resists all chemicals except hydrofluoric acids. Withstands temperatures up to 900°F. Heat sink fighter.

**Plastic:** We offer static dissipative plastic tweezers. Plastic tweezers are non magnetic, resist virtually all commercial solvents. Non absorbent and easy to clean. Tips are non-marring.

**Carbofib:** Fully ESD Safe (102 ohm) but at the same time, soft and non scratching. These conductive synthetic fiber tips are ideally suited to handle delicate and fragile components when extreme care and ESD safety are an absolute necessity. Every tweezers is manually finished and tested for maximum precision. Chemical resistant and heat resistant up to 256°C.

Quality Grades (Table 1)	
Accu-Tek ◆◆◆◆	Made from the finest steels. Perfectly Balanced for a superior feel. Light weight with soft tension with accurately finished points. Recommended for work under high power magnification aerospace and micro electronics and in applications where high precision is required. All Accu-Tek precision tweezers are made from anti-acid, anti-magnetic stainless steel.
Technik ◆◆◆	Finely crafted tweezers. Anti-glare finish to reduce eye strain. Hand finished points for accuracy. Recommended for micro electronics and precision assembly.

# Tweezers

Precision Tweezers

## Style AA Tweezers

For general assembly, very strong and precise tips with fine finish. Available in different materials and quality grades. Length: 5" (130mm)

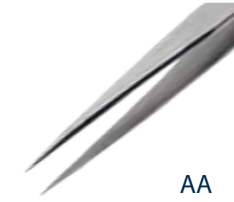

Product ID	Description	Material
18013-BR	Accu-Tek Tweezers AM-BR	Brass
18013USA	Technik Tweezers AA-SA	Stainless Steel
18011-CS	Aven Tweezers AA-CS	Carbon Steel, Nickel/Chrome Plated
18013TS	Accu-Tek AA (Swiss Made)	Titanium
18013TT	Aven Tweezers AA	Titanium
18013EZ	E-Z Pik Tweezers AA Yellow	Stainless Steel

## Style AC Tweezers

Sturdy tips for bending and handling very fine wire and components. Tweezers feature finger grips. Available in different materials and quality grades. Length: 4-3/4" (120mm)

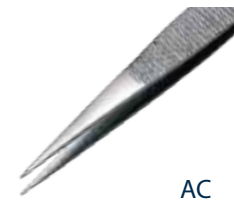

Product ID	Description	Material
18016USA	Technik Tweezers AC-SA	Stainless Steel
18014-CS	Aven Tweezers AC-CS	Carbon Steel, Nickel/Chrome Plated

## Style MM Tweezers

General purpose, tweezers with hardened, precision tips and fine finish. Available in different materials and quality grades. Length: 5" (130mm)

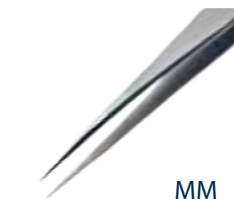

Product ID	Description	Material
18023USA	Technik Tweezers MM-SA	Stainless Steel
18014-CS	Aven Tweezers MM-CS	Carbon Steel, Nickel/Chrome Plated

## Style 00 Tweezers

Flat edges, heavy duty strong blades tapering to a regular strong point. Available in different materials and quality grades. Length: 4-3/4" (120mm)

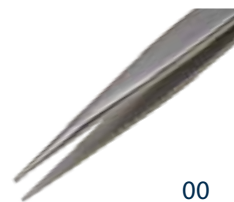

Product ID	Description	Material
18032ACU	Accu-Tek Tweezers 00-SA	Stainless Steel
18032USA	Technik Tweezers 00-SA	Stainless Steel
18032-CS	Aven Tweezers 00-CS	Carbon Steel, Nickel/Chrome Plated
18032TS	Accu-Tek 00 (Swiss Made)	Titanium
18032TT	Aven Tweezers 00	Titanium
18032EZ	E-Z Pik Tweezers 00 Red	Stainless Steel
18032-ER	Comfort Grip Tweezers 00-SA	Stainless Steel



## Style 00C Tweezers

Flat edges, heavy duty strong blades tapering to a regular strong point. Slightly shorter than 00. Length: 4-1/2" (115mm)

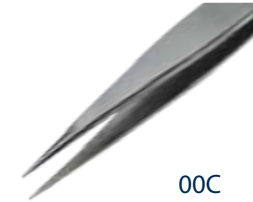

Product ID	Description	Material
18034USA	Technik Tweezers 00C-SA	Stainless Steel

## Style 00D Tweezers

Flat edges, heavy duty strong blades tapering to a regular strong point. Tweezers feature finger grips. Available in different materials and quality grades. Length: 4-3/4" (120mm)

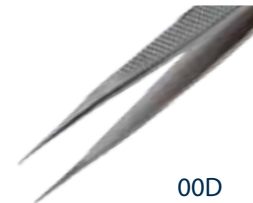

Product ID	Description	Material
18037ACU	Accu-Tek Tweezers 00D-SA	Stainless Steel
18037-MS	Mini 00D-SA (Swiss Made)	Stainless Steel
18037USA	Technik Tweezers 00D-SA	Stainless Steel
18036-CS	Aven Tweezers 00D-CS	Carbon Steel, Nickel/Chrome Plated
18037TT	Aven Titanium Tweezers 00D	Titanium

## Style 0 Tweezers

Extremely fine straight points for general handling and positioning of miniature parts or fine wire. Available in different quality grades. Length: 4-3/4" (120mm)



Product ID	Description	Material
18026ACU	Accu-Tek Tweezers 0-SA	Stainless Steel
18026USA	Technik Tweezers 0-SA	Stainless Steel

## Style 0A Tweezers

Straight point tweezers with radius edges are uniquely designed for working in small yet dense areas. Length: 4-3/4" (120mm)

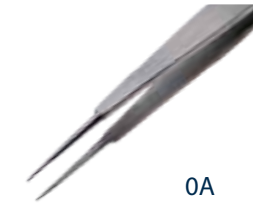

Product ID	Description	Material
18027USA	Technik Tweezers 0A-SA	Stainless Steel

## Style 0C Tweezers

Straight point tweezers with flat edges, fine tips and shortened overall length for delicate handling of small parts. Available in different quality grades. Length: 3-1/2" (90mm)

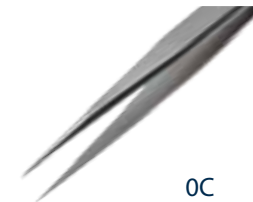

Product ID	Description	Material
18029ACU	Accu-Tek Tweezers 0C-SA	Stainless Steel
18029USA	Technik Tweezers 0C-SA	Stainless Steel



### Style SS Tweezers

Extra long and narrow, straight point tweezers. Provides extended reach and access to confined areas. Available in different quality grades. Length: 5-1/2" (140mm)

Product ID	Description	Material
18040ACU	Accu-Tek Tweezers SS-SA	Stainless Steel
18040ACU	Artis Tweezers SS-SA	Stainless Steel
18040USA	Technik Tweezers SS-SA	Stainless Steel

### Style 1 Tweezers

Designed for general use featuring strong blades with fine points. Available in different materials and quality grades. Length: 4-3/4" (120mm)

Product ID	Description	Material
18043ACU	Accu-Tek Tweezers 1-SA	Stainless Steel
18043USA	Technik Tweezers 1-SA	Stainless Steel
18043-CS	Aven Tweezers 1-CS	Carbon Steel, Nickel/Chrome Plated
18043ARS	Artis Tweezers 1-SA	Stainless Steel
18043TT	Aven Titanium Tweezers 1	Titanium

### Style 2 Tweezers

Tapered, sharp point tweezers for bending and handling of small wires and parts. Available in different materials and quality grades. Length: 4-3/4" (120mm)

Product ID	Description	Material
18046ACU	Accu-Tek Tweezers 2-SA	Stainless Steel
18046-MS	Mini 2-SA (Swiss Made)	Stainless Steel
18046USA	Technik Tweezers 2-SA	Stainless Steel
18046-CS	Aven Tweezers 2-CS	Carbon Steel, Nickel/Chrome Plated
18046TS	Accu-Tek 2 (Swiss Made)	Titanium
18046TT	Aven Titanium Tweezers 2	Titanium

### Style 2A Tweezers

Straight Flat Tips. Provides large flat gripping surface. Available in different materials and quality grades. Length: 4-3/4" (120mm)

Product ID	Description	Material
18049ACU	Accu-Tek Tweezers 2A-SA	Stainless Steel
18049-MS	Mini 2A-SA (Swiss Made)	Stainless Steel
18049USA	Technik Tweezers 2A-SA	Stainless Steel
18049-CS	Aven Tweezers 2A-CS	Carbon Steel, Nickel/Chrome Plated
18049TS	Accu-Tek 2A (Swiss Made)	Titanium
18049TT	Aven Titanium Tweezers 2A	Titanium
18049EZ	E-Z Pik Tweezers 2A Black	Stainless Steel
18049-ER	Comfort Grip Tweezers 2A-SA	Stainless Steel
18043-ARS	Artis Tweezers 2A-SA	Stainless Steel

## Tweezers

### Precision Tweezers

#### Style 2AB Tweezers

Style 2AB Tweezers feature curved round tips, ideal for handling delicate or small parts. Tip angle facilitates wafer tray loading. Length: 4-3/4" (120mm)

Product ID	Description	Material
18050USA	Technik Tweezers 2AB-SA	Stainless Steel

#### Style 3 Tweezers

Fine point tweezers for general assembly or light magnification applications. Available in different materials and quality grades. Length: 4-3/4" (120mm)

Product ID	Description	Material
18053ACU	Accu-Tek Tweezers 3-SA	Stainless Steel
18053-MS	Mini 3-SA (Swiss Made)	Stainless Steel
18053USA	Technik Tweezers 3-SA	Stainless Steel
18053-CS	Aven Tweezers 3-CS	Carbon Steel, Nickel/Chrome Plated
18053TS	Accu-Tek 3 (Swiss Made)	Titanium
18053TT	Aven Titanium Tweezers 3	Titanium

#### Style 3C Tweezers

Fine point tweezers, slightly shorter than #3, for general assembly or light magnification applications. Available in different materials and quality grades. Length: 4-1/4" (110mm)

Product ID	Description	Material
18056ACU	Accu-Tek Tweezers 3C-SA	Stainless Steel
18056USA	Technik Tweezers 3C-SA	Stainless Steel
18054-CS	Aven Tweezers 3C-CS	Carbon Steel, Nickel/Chrome Plated
18056TS	Accu-Tek 3C (Swiss Made)	Titanium
18056TT	Aven Titanium Tweezers 3C	Titanium
18056EZ	E-Z Pik Tweezers 3C Light Blue	Stainless Steel
18056-ER	Comfort Grip Tweezers 3C-SA	Stainless Steel
18056ARS	Artis Tweezers 3C-SA	Stainless Steel

#### Style 3CB Tweezers

Long and narrow bent tip tweezers. Provides extended reach and access to confined areas. Length: 4-1/4" (110mm)

Product ID	Description	Material
18078ACU	Accu-Tek Tweezers 3CB-SA	Stainless Steel

#### Style 3F Tweezers

Tips touch over 3mm for holding tiny wires. Length: 4-3/4" (120mm)

Product ID	Description	Material
18079ACU	Accu-Tek Tweezers 3F-SA	Stainless Steel

## Tweezers

### Precision Tweezers

#### Style 35A Tweezers

Ideal for handling wafers, delicate parts, and delicate assembly work. Length: 4-3/4" (120mm)

Product ID	Description	Material
18201USA	Aven Tweezers 35A-SA	Stainless Steel

#### Style 36 Tweezers

Angled broad tip tweezers feature large paddle style tips. Wide tips provide firm grip. Length: 4-3/4" (120mm)

Product ID	Description	Material
18202USA	Aven Tweezers 36-SA	Stainless Steel

#### Style 4 Tweezers

Designed for extra fine work. Blades taper sharply from body to form very fine long rounded points. Available in different materials and quality grades. Length: 4-1/4" (110mm)

Product ID	Description	Material
18059ACU	Accu-Tek Tweezers 4-SA	Stainless Steel
18059USA	Technik Tweezers 4-SA	Stainless Steel
18057-CS	Aven Tweezers 4-CS	Carbon Steel, Nickel/Chrome Plated
18059TT	Aven Titanium Tweezers 4	Titanium

#### Style 5 Tweezers

Designed for extra fine work with long blades which break sharply from body and taper to the sharpest points available. Available in different materials and quality grades. Length: 4-1/4" (110mm)

Product ID	Description	Material
18062ACU	Accu-Tek Tweezers 5-SA	Stainless Steel
18062-MS	Mini 5-SA (Swiss Made)	Stainless Steel
18062USA	Technik Tweezers 5-SA	Stainless Steel
18060-CS	Aven Tweezers 5-CS	Carbon Steel, Nickel/Chrome Plated
18062TS	Accu-Tek 5 (Swiss Made)	Titanium
18062TT	Aven Titanium Tweezers 5	Titanium
18062EZ	E-Z Pik Tweezers 5 Green	Stainless Steel
18062-ER	Comfort Grip Tweezers 5-SA	Stainless Steel
18062ARS	Artis Tweezer 5-SA	Stainless Steel

#### Style 5A Tweezers

Features the sharpest points available. The oblique fine points provide greater visibility. Available in different materials and quality grades. Length: 4-1/2" (115mm)

Product ID	Description	Material
18065ACU	Accu-Tek Tweezers 5A-SA	Stainless Steel
18065USA	Technik Tweezers 5A-SA	Stainless Steel
18065TT	Aven Titanium Tweezers 5A	Titanium



#### Style 5B Tweezers

Features super micro high precision bent tips provide maximum visibility. Available in different materials and quality grades. Length: 4-1/4" (110mm)

Product ID	Description	Material
18066USA	Technik Tweezers 5B-SA	Stainless Steel
18066-CS	Aven Tweezers 5B-CS	Carbon Steel, Nickel/Chrome Plated

#### Style 6 Tweezers

Angled fine tip is designed to allow greater access into tight areas. Available in different materials and quality grades. Length: 4-3/4" (120mm)

Product ID	Description	Material
18069ACU	Accu-Tek Tweezers 6-SA	Stainless Steel
18069USA	Technik Tweezers 6-SA	Stainless Steel
18067-CS	Aven Tweezers 6-CS	Carbon Steel, Nickel/Chrome Plated
18069TS	Accu-Tek 6 (Swiss Made)	Titanium
18069TT	Aven Titanium Tweezers 6	Titanium

#### Style 65A Tweezers

Long fine curved tips are designed to allow greater access into tight areas. Length: 5-1/2" (140mm)

Product ID	Description	Material
18076ACU	Accu-Tek Tweezers 65A-SA	Stainless Steel

#### Style 66 Tweezers

Long double bent tips are designed to allow greater access into tight areas. Length: 5-1/2" (140mm)

Product ID	Description	Material
18077ACU	Accu-Tek Tweezers 66-SA	Stainless Steel

#### Style 7 Tweezers

Designed with curved, super fine points for easy assembly work, allowing hand to rest on bench. Available in different materials and quality grades. Length: 4-1/2" (115mm)

Product ID	Description	Material
18072ACU	Accu-Tek Tweezers 7-SA	Stainless Steel
18072USA	Technik Tweezers 7-SA	Stainless Steel
18070-CS	Aven Tweezers 7-CS	Carbon Steel, Nickel/Chrome Plated
18072TS	Accu-Tek 7 (Swiss Made)	Titanium
18072TT	Aven Titanium Tweezers 7	Titanium
18072EZ	E-Z Pik Tweezers 7 Orange	Stainless Steel
18072-ER	Comfort Grip Tweezers 7-SA	Stainless Steel



### Style 7B Tweezers

Similar to style 7, pattern 7B tweezers feature serrated tips and have been designed with curved, super fine points for easy assembly work, allowing hand to rest on bench. Length: 4-1/2" (115mm)



Product ID	Description	Material
18074USA	Technik Tweezers 7B-SA	Stainless Steel

### Style 15AWG Tweezers

Designed for culling hairsprings and electronic component wires. The blades, made from 400 series stainless steel induction for durability, feature hardened tips. Length: 4-1/2" (115mm)

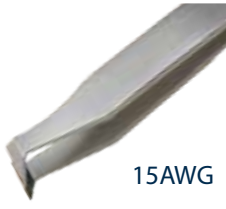

Product ID	Description	Material
18114ACU	Accu-Tek Tweezers 15AWG-SA	Stainless Steel

### Aven 6-Piece Tweezer Set

- ▶ Stainless steel finish provides excellent corrosion resistance
- ▶ Ideal for bending, separating and removing small items
- ▶ Curved and straight tip tweezers are helpful when working in confined spaces
- ▶ Locking tweezers helpful for soldering and holding small parts



Product ID	Description
18472	Aven 6-Piece Tweezer Set

### Aven 5-Piece Tweezer Set

- ▶ Stainless steel finish provides excellent corrosion resistance
- ▶ Ideal for bending, separating and removing small items
- ▶ Curved and straight tip tweezers are helpful when working in confined spaces
- ▶ Locking tweezers helpful for soldering and holding small parts



Product ID	Description
18473	Aven 5-Piece Tweezer Set

### Technik 6-Piece Precision Tweezer Set

- ▶ Finely crafted tweezers
- ▶ Anti-glare finish to reduce eye strain
- ▶ Hand finished points for accuracy
- ▶ Ideal for micro electronics and precision assembly
- ▶ Contains AA-SA, OO-SA, OODSA, 3C-SA, 5-SA and 7-SA styles

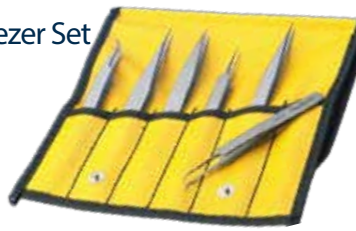

Product ID	Description
18475USA	Technik 6-Piece Precision Tweezer Set

## Tweezers

### Precision Tweezers

#### Technik 5-Piece Precision Tweezer Set

- ▶ Finely crafted tweezers
- ▶ Anti-glare finish to reduce eye strain
- ▶ Hand finished points for accuracy
- ▶ Ideal for micro electronics and precision assembly
- ▶ Contains OO-SA, OOD-SA, 3C-SA, 5-SA and 7-SA styles
- ▶ Supplied in an elegant padded wooden case



Product ID	Description
18476USA	Technik 5-Piece Precision Tweezer Set

#### E-Z Pik 6-Piece Tweezer Set

- ▶ Color coated for easy identification
- ▶ Contains AA-SA, OO-SA, OODSA, 3C-SA, 5-SA and 7-SA styles
- ▶ Stainless steel, anti-magnetic, anti-acid
- ▶ Highly durable special coating for high visibility and easy identification



Product ID	Description
18480EZ	E-Z Pik 6-Piece Tweezer Set

#### Titanium 6-Piece Precision Tweezer Set

- ▶ Aven's most popular titanium tweezer styles in a handy pouch
- ▶ Titanium tweezers do not shed particles like the stainless steel tweezers
- ▶ Light weight and high strength material
- ▶ Contains 2A, 3c, OO, AA, 5 and 7 styles
- ▶ Extremely useful when handling magnetic materials



Product ID	Description
18480TT	Titanium 6-Piece Precision Tweezer Set

#### Carbofib 3-CF Tweezers

These Swiss made, ESD safe tweezers feature excellent wear and abrasion resistance. Ideal for handling sensitive materials such as electronic components, micro-mechanical parts, glass and ceramic substrates, these tweezers provide very high rigidity, excellent tensile and flexural strength and have good chemical resistance to oils, grease, fuels, and non-polar solvents. Length: 5" (130mm)



Product ID	Description	Tip Style	Tip Width	Style
18702	Carbofib 302-CF Tweezers	Straight, Broad	2mm	302
18704	Carbofib 304-CF Tweezers	Straight, Ultra Fine	0.6mm	304
18760	Carbofib 3-CF Tweezers	Straight, Fine	0.8mm	3
18762	Carbofib 5-CF Tweezers	Straight, Ultra Fine	0.5mm	5
18767	Carbofib 2-CF Tweezers	Straight, Fine	0.8mm	2
18768	Carbofib 2A-CF Tweezers	Straight, Rounded	1.8mm	2A
18769	Carbofib 7-CF Tweezers	Curved, Fine	0.6mm	7

## Tweezers

### Plastic & Carbofib Tweezers

#### Style 2AB Plastic Tweezers

Curved with rounded tips and made of chemically resistant lightweight plastic, this anti-static tool will not damage sensitive electronic devices such as hard drives nor contaminate materials when used in corrosive environments.



Product ID	Description	Length
18514	Plastic Tweezers 2AB Curved, Flat Tips	4-1/2" (115mm)

#### Style 2C Plastic Tweezers

Straight with very fine tips and made of chemically resistant lightweight plastic, this anti-static tool will not damage sensitive electronic devices such as hard drives nor contaminate materials when used in corrosive environments.



Product ID	Description	Length
18517	Plastic Tweezers 2C Fine, Straight Tips	4-1/2" (115mm)

#### Style 7 Plastic Tweezers

Curved with very fine tips and made of chemically resistant lightweight plastic, this anti-static tool will not damage sensitive electronic devices such as hard drives nor contaminate materials when used in corrosive environments.



Product ID	Description	Length
18523	Plastic Tweezers 7 Fine, Curved Tips	4-1/2" (115mm)

#### Style 35 Plastic Tweezers

Straight with flat tips and made of chemically resistant lightweight plastic, this anti-static tool will not damage sensitive electronic devices such as hard drives nor contaminate materials when used in corrosive environments.

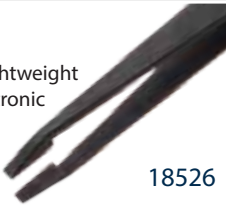

Product ID	Description	Length
18526	Plastic Tweezers 35 Straight, Flat Tips	4-1/2" (115mm)

#### Style 35A Plastic Tweezers

Straight with broad, flat tips and made of chemically resistant lightweight plastic, this anti-static tool will not damage sensitive electronic devices such as hard drives nor contaminate materials when used in corrosive environments.



Product ID	Description	Length
18529	Plastic Tweezers 35A Straight, Broad, Flat Tips	4-1/2" (115mm)

#### Style 702A ESD Plastic Tweezers

Manufactured from Polyetheretherketone reinforced with 30% carbon fiber (PEEK/CF30), these very hard, rigid, high tensile and flexural strength tweezers are ideal for the handling of components in cleaning, chemical, and assembly of components.

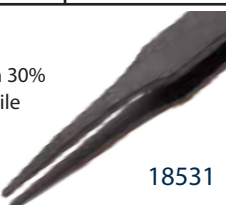

Product ID	Description	Length
18531	ESD Plastic Tweezers 702A Straight, Flat Tips	4-1/2" (115mm)



#### Style 705 ESD Plastic Tweezers

Manufactured from Polyetheretherketone reinforced with 30% carbon fiber (PEEK/CF30), these very hard, rigid, high tensile and flexural strength tweezers are ideal for the handling of components in cleaning, chemical, and assembly of components.



Product ID	Description	Length
18532	ESD Plastic Tweezers 705 Very Fine, Tapered Tips	4-1/2" (115mm)

#### Style 707 ESD Plastic Tweezers

Manufactured from Polyetheretherketone reinforced with 30% carbon fiber (PEEK/CF30), these very hard, rigid, high tensile and flexural strength tweezers are ideal for the handling of components in cleaning, chemical, and assembly of components.



Product ID	Description	Length
18533	ESD Plastic Tweezers 707 Fine Tips	4-1/2" (115mm)

#### Style 707A ESD Plastic Tweezers

Manufactured from Polyetheretherketone reinforced with 30% carbon fiber (PEEK/CF30), these very hard, rigid, high tensile and flexural strength tweezers are ideal for the handling of components in cleaning, chemical, and assembly of components.



Product ID	Description	Length
18534	ESD Plastic Tweezers 707A Curved, Fine Tips	4-1/2" (115mm)

#### Style 709 ESD Plastic Tweezers

Manufactured from Polyetheretherketone reinforced with 30% carbon fiber (PEEK/CF30), these very hard, rigid, high tensile and flexural strength tweezers are ideal for the handling of components in cleaning, chemical, and assembly of components.



Product ID	Description	Length
18535	ESD Plastic Tweezers 709 Broad, Flat Tips	4-1/2" (115mm)

#### Style 710 ESD Plastic Tweezers

Manufactured from Polyetheretherketone reinforced with 30% carbon fiber (PEEK/CF30), these very hard, rigid, high tensile and flexural strength tweezers are ideal for the handling of components in cleaning, chemical, and assembly of components.



Product ID	Description	Length
18536	ESD Plastic Tweezers 710 Wide, Flat Tips	4-1/2" (115mm)

Register online to receive updates on the newest products and for the latest specials from Aven.



# Tweezers

## Ceramic & General Purpose Tweezers

### Victor Ceramic Tweezers

- ▶ Low thermal conductivity and high thermal shock resistance
- ▶ Ceramic tweezers are used in applications where extreme heat is present
- ▶ Highly resistant to all strong acids except hydrofluoric
- ▶ Chemically and electrically inert
- ▶ Solder will not adhere to surface



18801

Product ID	Description	Material
18801	Ceramic Tweezers 1mm Serrated Tips	Ceramic
18802	Ceramic Tweezers 1mm Smooth Tips	Ceramic
18803	Ceramic Tweezers Ultra Fine Smooth Tips	Ceramic
18804	Ceramic Tweezers Curved Fine Smooth Tips	Ceramic

### Accu-Tek Ceramic Tweezers

- ▶ Low thermal conductivity and high thermal shock resistance
- ▶ 100% non magnetic, non rusting and non static
- ▶ Highly resistant to all strong acids except hydrofluoric
- ▶ Solder will not adhere to surface
- ▶ Will hold tip geometry better than metal
- ▶ Swiss made stainless steel handles



18811

Product ID	Description	Material
18810	Ceramic Tweezers Pattern 71	Ceramic Tips/Stainless Steel Bodies
18811	Ceramic Tweezers Pattern 72	Ceramic Tips/Stainless Steel Bodies
18812	Ceramic Tweezers Pattern 73	Ceramic Tips/Stainless Steel Bodies
18813	Ceramic Tweezers Pattern 74	Ceramic Tips/Stainless Steel Bodies
18814	Ceramic Tweezers Pattern 7MZ	Ceramic Tips/Stainless Steel Bodies

### Aven Fiber Grip Tweezers

- ▶ Polished stainless steel tips firmly hold without contaminating
- ▶ Heat-resistant fiber grips protect your hands from heat while soldering
- ▶ Ideal for soldering, bending, separating and removing small items
- ▶ Cross-lock mechanism opens when pressed

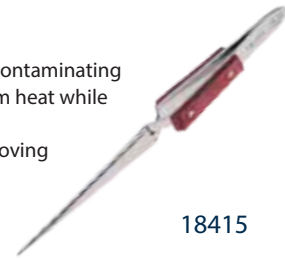

18415

Product ID	Description
18415	Aven Fiber Grip Tweezers - Straight
18417	Aven Fiber Grip Tweezers - Curved

### Aven Self Locking Tweezers

- ▶ Stainless steel finish provides excellent corrosion resistance
- ▶ Ideal for bending, separating and removing small items
- ▶ Cross-lock mechanism opens when pressed and closes when released

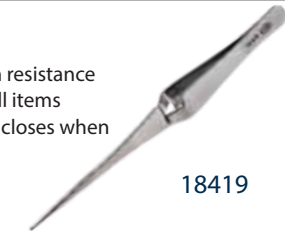

18419

Product ID	Description
18419	Aven Self Locking Tweezers - Narrow
18421	Aven Self Locking Tweezers - Wide
18423	Aven Self Locking Tweezers - Narrow Short

### Aven College Forceps w/Lock

- ▶ Stainless steel finish provides excellent corrosion resistance
- ▶ Ideal for bending, separating and removing small items
- ▶ Curved tip is helpful when working in confined spaces



18400

Product ID	Description
18400	Aven College Forceps w/Lock

### Aven College Forceps w/Alignment Pin

- ▶ Stainless steel finish provides excellent corrosion resistance
- ▶ Alignment pin keeps tips aligned under high stress applications
- ▶ Inside and outside serrations provide better gripping and handling



18402

Product ID	Description	Tip Style
18401	Aven College Forceps w/Alignment Pin	Straight, Serrated
18402	Aven College Forceps w/Alignment Pin	Curved, Serrated
18403	Aven College Forceps w/Alignment Pin	Offset Curved, Serrated
18438	Aven College Forceps w/Alignment Pin	Curved, Serrated

### Aven Forceps w/Plastic Coated Tips

- ▶ Stainless steel finish provides excellent corrosion resistance
- ▶ Plastic coated tips provide chemical resistance
- ▶ Serrated handles provide better gripping



18430

Product ID	Description
18430	Aven 8" Forceps w/Plastic Coated Tips
18431	Aven 12" Forceps w/Plastic Coated Tips

### Aven Forceps w/Straight Serrated Tips

- ▶ Stainless steel finish provides excellent corrosion resistance
- ▶ Ideal for bending, separating and removing small items
- ▶ Long, straight tip is helpful when working in confined spaces
- ▶ Serrated handles provide better gripping



18436

Product ID	Description
18432	Aven 12" Forceps w/Straight Serrated Tips
18433	Aven 10" Forceps w/Straight Serrated Tips
18434	Aven 8" Forceps w/Straight Serrated Tips
18435	Aven 6" Forceps w/Straight Serrated Tips
18436	Aven 5" Forceps w/Straight Serrated Tips

### Aven Cross Locking Tweezers

- ▶ Stainless steel finish provides excellent corrosion resistance
- ▶ Ideal for soldering and holding small parts



18428

Product ID	Description
18428	Aven Cross Locking Tweezers

# Tweezers

## General Purpose & Quick Test Tweezers

### Aven Utility Tweezers

- ▶ Stainless steel finish provides excellent corrosion resistance
- ▶ Ideal for bending, separating and removing small items
- ▶ Serrated handles provide better gripping



18425

Product ID	Description	Tip Style
18425	Aven 7" Utility Tweezers - Curved	Curved, Serrated
18426	Aven 7" Utility Tweezers - Straight	Straight, Serrated

### Aven 4 3/8" General Purpose Tweezers

- ▶ Stainless steel finish provides excellent corrosion resistance
- ▶ Ideal for bending, separating and removing small items
- ▶ Serrated handles provide better gripping



18481

Product ID	Description	Tip Style
18481	Aven 4 3/8" Curved Tweezers	Curved, Serrated
18482	Aven 4 3/8" Tapered Tweezers	Tapered, Smooth

### Aven Blunt Tip Tweezers

- ▶ Stainless steel finish provides excellent corrosion resistance
- ▶ Ideal for bending, separating and removing small items
- ▶ Serrated handles provide better gripping
- ▶ Blunt tips are useful for handling larger items



18481

Product ID	Description	Tip Style
18486	Aven 3 1/8" Blunt Tweezers	Blunt, Smooth
18490	Aven 5 15/16" Blunt Tweezers	Blunt, Serrated
18492	Aven 10" Blunt Tweezers	Blunt, Serrated

### Aven 3" Sharp Tweezers

- ▶ Stainless steel finish provides excellent corrosion resistance
- ▶ Ideal for bending, separating and removing small items
- ▶ Medium-sharp, serrated tip is helpful when working in confined spaces
- ▶ Serrated handles provide better gripping



18483

Product ID	Description	Tip Style
18483	Aven 3" Sharp Tweezers	Medium Sharp, Serrated

### Aven General Purpose Flat Tip Tweezers

- ▶ Stainless steel finish provides excellent corrosion resistance
- ▶ Ideal for bending, separating and removing small items



18484

18485

18489

Product ID	Description	Tip Style
18484	Aven 3 1/8" Tweezers	Sharp-Flat
18485	Aven 3 1/2" Tweezers	Sharp-Flat
18489	Aven 4 3/4" Smooth Tweezers	Sharp-Flat

### Aven 4 3/8" Spade Tweezers

- ▶ Stainless steel finish provides excellent corrosion resistance
- ▶ Ideal for bending, separating and removing small items
- ▶ Spade tip is helpful when working in confined spaces
- ▶ Serrated handles provide better gripping



18487

Product ID	Description	Tip Style
18487	Aven 4 3/8" Spade Tweezers	Spade

### Aven Offset Spade Tweezers

- ▶ Stainless steel finish provides excellent corrosion resistance
- ▶ Ideal for bending, separating and removing small items
- ▶ Spade tip is helpful when working in confined spaces
- ▶ Serrated handles provide better gripping



18488

Product ID	Description	Tip Style
18488	Aven 4 1/8" Offset Spade Tweezers	Spade
18491	Aven 4 1/2" Offset Spade Tweezers	Spade

### Aven Toothed Tissue Forceps

- ▶ Stainless steel finish provides excellent corrosion resistance
- ▶ Ideal for bending, separating and removing small items
- ▶ Toothed models are ideal for handling the various thicknesses of tissues



18494

Product ID	Description	Tip Style
18494	Aven Toothed Tissue Forceps	Toothed

### Quick-Test Auto-Scanning Tweezers

- ▶ Measures AC/DC voltage, resistance, continuity & diode test
- ▶ Auto Scanning Mode/Auto range
- ▶ Testing pins gold plated to reduce resistance and prevent rust
- ▶ Uses Lithium battery CR2032, included
- ▶ Will automatically identify whether component is a resistor, capacitor or diode



18910

Product ID	Description
18910	Quick-Test Auto-Scanning Tweezers

Register online to receive updates on the newest products and for the latest specials from Aven.



# Soldering & Desoldering

Soldering/Desoldering Tools & Accessories

## Soldering Station with LCD Display, ESD Safe 400 Series

- ▶ High-quality sensor and heat exchange system guarantee precise temperature control at the soldering tip
- ▶ Soldering iron tool heats rapidly from room temperature to 350C in 30 seconds
- ▶ Suitable for general purpose soldering as well as specialized lead-free soldering applications
- ▶ Sponge and coiled brass tip cleaner ensure a clean soldering tip free from debris and corrosive material
- ▶ Strong, deluxe iron holder provides safe secure place to store heated iron between uses



Product ID	Description
17400	Soldering Station with LCD Display, ESD Safe 400 Series

## Soldering Station with LCD Display, ESD Safe 405 Series

- ▶ LCD temperature control display with blue backlight
- ▶ Long lasting, durable high - quality ceramic heater
- ▶ Sponge and recessed area provides a convenient method for cleaning the tip
- ▶ Suitable for general purpose soldering as well as specialized lead-free soldering applications
- ▶ Safety guard iron holder



Product ID	Description
17405	Soldering Station with LCD Display, ESD Safe 405 Series

## Soldering Kit - 6pc

- ▶ 40 Watt Soldering Iron heats up to 900° F
- ▶ Ideal for use on electrical/electronic components, audio equipment, etc.
- ▶ Includes desoldering pump for removing liquid solder
- ▶ Provides basic tools needed for many soldering projects
- ▶ 6 Pc kit comes complete with replaceable fine tip



Product ID	Description
17501	Soldering Kit - 6pc

## Soldering Kit - 7pc

- ▶ 40 Watt Soldering Iron heats up to 900° F
- ▶ Ideal for use on electrical/electronic components, audio equipment, etc.
- ▶ Includes desoldering pump for removing liquid solder
- ▶ Provides basic tools needed for many soldering projects
- ▶ 6 Pc kit comes complete with replaceable fine tip



Product ID	Description
17502	Soldering Kit - 7pc

## Soldering Iron 80W with Fine Tip

- ▶ Ideal for general purpose soldering applications including metal board, tube or large components
- ▶ Round, soft grip, non-slip handle
- ▶ Durable cord with a 5-foot reach
- ▶ Fitted with long life replaceable fine tip



Product ID	Description
17521	Soldering Iron 40W with Fine Tip

## Soldering Iron 40W with Fine Tip

- ▶ Ideal for general purpose soldering
- ▶ Round, soft grip, non-slip handle
- ▶ Durable cord with a 5-foot reach
- ▶ Fitted with long life replaceable fine tip



Product ID	Description
17521	Soldering Iron 40W with Fine Tip

## N-Series Soldering Iron Tips

- ▶ Long life, lead-free soldering iron tips
- ▶ Replacement tips for soldering the different components of PCBs
- ▶ Five different sizes
- ▶ Includes two tips
- ▶ For use with 17400 & 17405 ESD Safe Soldering Stations with LCD Display



Product ID	Description
17400-N9-1	N-Series Soldering Iron Tips (N9-1)
17400-N9-2	N-Series Soldering Iron Tips (N9-2)
17400-N9-3	N-Series Soldering Iron Tips (N9-3)
17400-N9-4	N-Series Soldering Iron Tips (N9-4)
17400-N9-5	N-Series Soldering Iron Tips (N9-5)

## C-Series Soldering Iron Tips

- ▶ Long life, lead-free soldering iron tips
- ▶ Replacement tips for soldering the different components of PCBs
- ▶ Four different sizes
- ▶ Includes two tips
- ▶ For use with 17521 Soldering Iron 40W



Product ID	Description
17521-C1-1	C-Series Soldering Iron Tips (C1-1)
17521-C1-2	C-Series Soldering Iron Tips (C1-2)
17521-C1-3	C-Series Soldering Iron Tips (C1-3)
17521-C1-4	C-Series Soldering Iron Tips (C1-4)

## B-Series Soldering Iron Tips

- ▶ Long life, lead-free soldering iron tips
- ▶ Includes two tips
- ▶ For use with 17510 Soldering Iron 80W



Product ID	Description
17510-B5-1	B-Series Soldering Iron Tips (B5-1)

# Soldering & Desoldering

Soldering/Desoldering Tools & Accessories



## Lead Free Solder Pot 100W

- ▶ Heating element liquifies solder quickly and provides excellent thermal stability
- ▶ Crucible is made from stainless steel with titanium plating, featuring corrosion resistance and prolonged service life
- ▶ Suitable for melting solder, plastic, resin and more
- ▶ Ideal for tinning ends of stranded wire leads, pre-tinning small electrical parts and dip soldering small circuit boards



Product ID	Description	Solder Pot Capacity
17100-100	Lead Free Solder Pot 100W	250g

## Lead Free Solder Pot 150W

- ▶ Heating element liquifies solder quickly and provides excellent thermal stability
- ▶ Crucible is made from stainless steel with titanium plating, featuring corrosion resistance and prolonged service life
- ▶ Suitable for melting solder, plastic, resin and more
- ▶ Ideal for tinning ends of stranded wire leads, pre-tinning small electrical parts and dip soldering small circuit boards



Product ID	Description	Solder Pot Capacity
17100-150	Lead Free Solder Pot 150W	500g

## Lead Free Solder Pot 200W

- ▶ Heating element liquifies solder quickly and provides excellent thermal stability
- ▶ Crucible is made from stainless steel with titanium plating, featuring corrosion resistance and prolonged service life
- ▶ Suitable for melting solder, plastic, resin and more
- ▶ Ideal for tinning ends of stranded wire leads, pre-tinning small electrical parts and dip soldering small circuit boards



Product ID	Description	Solder Pot Capacity
17100-200	Lead Free Solder Pot 200W	800g

## Desoldering Pump - High Impact Plastic 13"

- ▶ Durable corrosion resistant plastic construction with precision metal plunger
- ▶ Cushioned shock reduction minimizes board damage
- ▶ Teflon (PTFE) non-stick coated tip
- ▶ Easy to clean one-touch cylinder

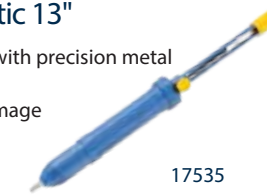

Product ID	Description
17535	Desoldering Pump - High Impact Plastic 13"

## Desoldering Pump - ESD Safe Plastic 8.5"

- ▶ Durable corrosion resistant plastic construction
- ▶ Easy to clean one-touch cylinder
- ▶ Cushioned shock reduction minimizes board damage



Product ID	Description
17536	Desoldering Pump - ESD Safe Plastic 8.5"

## Desoldering Pump - Metal Body 7.5"

- ▶ Durable corrosion resistant aluminum construction with precision metal plunger
- ▶ Cushioned shock reduction minimizes board damage
- ▶ Push Button for Easy Plunger Release
- ▶ Easy to clean one-touch cylinder



Product ID	Description
17537	Desoldering Pump - Metal Body 7.5"

## Portable Soldering Iron 30-70W

- ▶ 30 to 70 Watt power range
- ▶ Cordless, Simple and Safe Operation
- ▶ Ready to use in 20 seconds after Ignition
- ▶ Adjustable tip temperature from 400°C to 1300°C (750°F to 2500°F)
- ▶ Supplied with 1mm Conical Tip



Product ID	Description
17801	Portable Soldering Iron 30-70W
17801-T01	T-01 1mm Conical Tip
17801-T02	T-02 2mm Chisel Tip
17801-S05	S-05 Hot Knife Tip
17801-S07	S-07 Heat Blower Tip
17801-S30	S-30 Deflector Tip

## Solder Core Wire

- ▶ Good solderability, no spattering and non-corrosive
- ▶ Leaded solder 60/40 | Lead-free solder 99.3/0.7
- ▶ 360-440° F melting point
- ▶ 1-1.2mm diameter solder available
- ▶ Ideal for use on PCB, electronic devices and fine electrical soldering

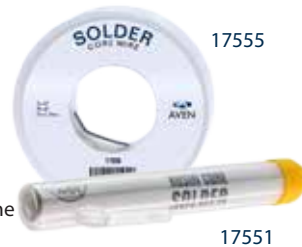

Product ID	Description
17553	Solder 100g 1.2mm 60/40
17555	Solder 100g 1.0mm 60/40
17553LF	Solder 100g 1.2mm Lead Free
17555LF	Solder 100g 1.0mm Lead Free
17551	Solder in Tube 1.0mm 60/40
17552	Solder in Tube 1.2mm 60/40
17551LF	Solder in Tube 1.0mm Lead Free
17552LF	Solder in Tube 1.2mm Lead Free

## Desoldering Wick

- ▶ Made of clean, oxide-free copper wire
- ▶ Tight weave enables quick "on and off" desoldering
- ▶ Concentrated fine copper braiding utilizes less length of wick for each desoldering application
- ▶ RoHS compliant



Product ID	Description
17540	Desoldering Wick 1.5mm (0.06")
17541	Desoldering Wick 2mm (0.08")
17542	Desoldering Wick 2.5mm (0.1")



# Soldering & Desoldering

Benchtop Accessories & Soldering Aids

## Benchtop Smoke Absorber

- ▶ Removes flux fumes from soldering work bench
- ▶ Fumes absorbed by carbon activated filter
- ▶ Fan is quiet and will not add significant noise to your workspace
- ▶ Stand allows the smoke absorber to be adjusted to varying angles



17701

Product ID	Description
17701	Benchtop Smoke Absorber
17701F	Carbon Activated Filter 3pcs with PVC Bag

## Static Eliminator

- ▶ Provides optimum protection from the destructive effects of electrostatic discharge (ESD)
- ▶ Variable speed fan produces an air volume from 35 to 70 CFM
- ▶ Covers area of 1 x 5 feet
- ▶ Self balancing to +/- 5V
- ▶ Voltage: 110-120V



17703

Product ID	Description
17703	Static Eliminator

## Solder Reel Stand

- ▶ Allows solder wire to be drawn out smoothly
- ▶ Compact design keeps work benches neat and orderly
- ▶ Holds up to 1kg (approximately 2lbs.) roll of solder wire
- ▶ Solder reel stand is the ideal solution for easy soldering wire supply



17560

Product ID	Description
17560	Solder Reel Stand

## Soldering Iron Stands

- ▶ Ideal for holding pencil type soldering irons
- ▶ Weighted metal base features built in sponge tray
- ▶ Designed to withstand everyday industrial use
- ▶ Two per pack



17533

Product ID	Description
17533	Solder Iron Stands

## Soldering Iron Stand with Soft Coiled Brass Tip Cleaner

### Tip Cleaner

- ▶ Replaceable soft coiled brass tip cleaner
- ▶ Cleans tip without messy wet sponges
- ▶ Uses low abrasive brass, no water needed
- ▶ Works with any tip
- ▶ Lengthens tip life by reducing oxidation
- ▶ Sturdy heavy duty stand with built in tip cleaner



17530

Product ID	Description
17530	Soldering Iron Stand with Soft Coiled Brass Tip Cleaner
17530-TC	Soft Coiled Brass Tip Cleaner

## Adjustable Circuit Board Holder

- ▶ Retractable to accommodate various board sizes up to 198mm wide and up to 4mm thick
- ▶ Clamps allow PCB to rotate 360°
- ▶ Rigid metal structure
- ▶ Rubber feet of the base ensure stability
- ▶ Ideal for clamping PCB, for soldering/desoldering or rework

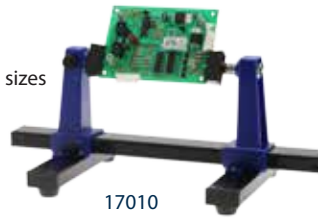

17010

Product ID	Description
17010	Adjustable Circuit Board Holder

## Helping Hands Magnifier with Clamps

- ▶ Useful auxiliary tool in soldering, model making and other hobbies
- ▶ Heavy-duty cast iron base provides stability
- ▶ Magnifier can be swiveled and fixed to desired position or angle
- ▶ Two alligator spring clips that hold work firmly in any position
- ▶ 2x magnifier is removable



26000

Product ID	Description
26000	Helping Hands Magnifier with Clamps

## Third Hand w/Tweezers

- ▶ Stainless steel construction
- ▶ Heavy-duty base provides excellent stability and prevents movement
- ▶ Designed as a "third hand" allowing both hands free for soldering
- ▶ Multi-position swivel clamps permit holding of piece at any angle



17012

Product ID	Description
17012	Third Hand w/Tweezers

## 5-Piece Solder Aid Kit

- ▶ Popular solder aids
- ▶ Tweezer included
- ▶ Head sink included
- ▶ 5-piece set provides the right tool at the right time



17523

Product ID	Description
17523	5-Piece Solder Aid Kit

## Soldering Aids 6-Pc Kit

- ▶ Kit includes six of the most popular soldering aids
- ▶ Specialized tools to remove components from PCBs and clean holes choked with solder
- ▶ Brushes designed for cleaning surface contamination
- ▶ Scrapers remove shielding from wires and rust from metal to improve adhesion of solder



17524

Product ID	Description
17524	Soldering Aids 6-Pc Kit



AVEN, INC.  
4330 VARSITY DRIVE  
ANN ARBOR, MI 48108

Tel: 734.973.0099 | Fax: 734.973.0097 | www.aveninc.com

Follow Us on ventools