

TOLERANCE UNLESS OTHERWISE SPECIFIED IN MM:  
 0.0 ± 0.38 ANGLE °  
 0.00 ± 0.25  
 0.000 ± 0.10

THIS IS A C.A.D. GENERATED DRAWING  
 DO NOT MAKE MANUAL REVISIONS TO MASTER.

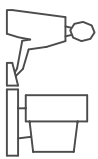

ISSUE NUMBER	1
ORIGINAL	1
UPDATE DRAWING	2
R.STA.MONICA	SEPT.23/2011

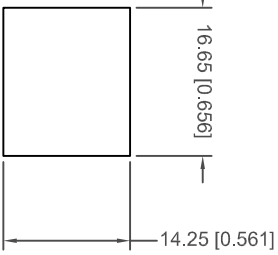
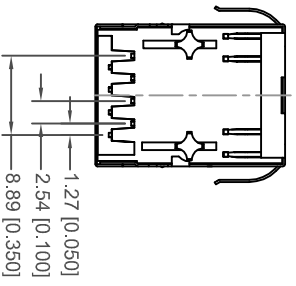
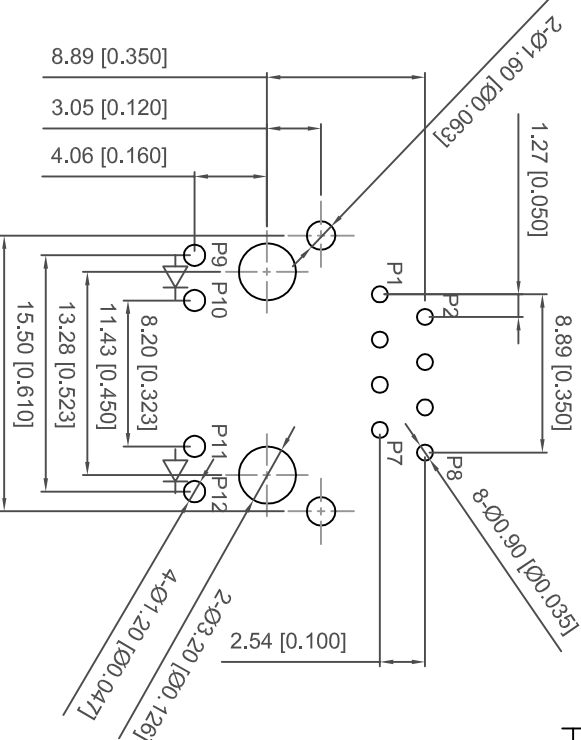
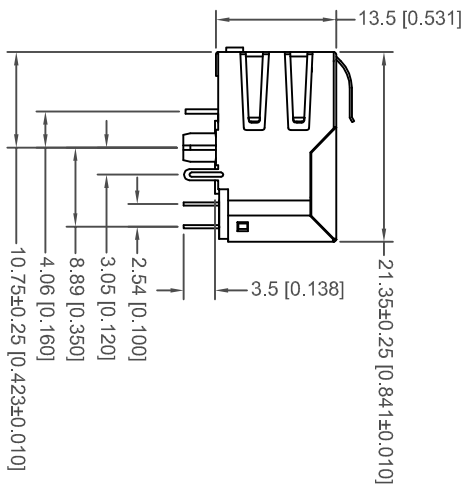
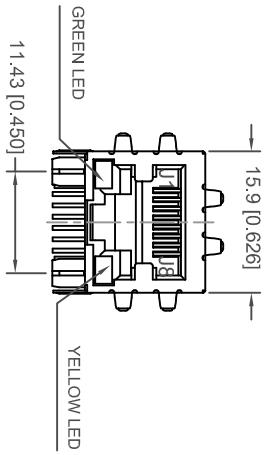

RECOMMENDED  
 PANEL CUTOUT DIMENSION

RECOMMENDED P.C.B. LAYOUT  
 TOLERANCE: ±0.08[±0.003]

NOTES:  
 1. MATERIALS:  
 HOUSING: THERMOPLASTIC PBT, UL94 V-0, COLOR: BLACK  
 CONTACTS: COPPER ALLOY PLATED WITH GOLD PLATING AND TIN IN SOLDER AREA

PART NO	GOLD PLATING THICKNESS
A63-112-331P431	GOLD FLASH PLATING
A63-113-331P431	15 MICRO INCHES OF GOLD
A63-114-331P431	30 MICRO INCHES OF GOLD

SHIELD: COPPER ALLOY WITH NICKEL PLATING  
 2. OPERATING TEMPERATURE: 0°C TO +70°C  
 3. STORAGE TEMPERATURE: -40°C TO +85°C  
 4. MATE WITH MODULAR PLUG CONFORMING TO FCC PART 68, SUBPART F.  
 5. RECOMMENDED TEMPERATURE FOR WAVE SOLDERING IS 260°C MAX, 10 SEC MAX  
 6. DIMENSION: MM [INCHES]



THIS SERIES FULLY CONFORMS TO THE  
 EUROPEAN UNION DIRECTIVES 2002/95/EC  
 AND 2002/96/EC FOR ROHS COMPLIANCY.

RJ45 MAGNETIC JACK WITH LED, 8P, 8C  
 SHIELDED/10/100 Mbps FILTER

ACAD REFERENCE NO.: A63-112-331P431

DRAWN: R.STA.MONICA DATE: NOV.19/2010

CHECKED: DATE:

PART NUMBER SHEET 1 OF 2

SEE NOTE

DRAWING NUMBER ISSUE

A63-112-331P431 2

EDAC INC  
 TORONTO, ONTARIO  
 CANADA

YOUR CONNECTION TO QUALITY & SERVICE

ELECTRICAL CIRCUIT:

THIS IS A C.A.D. GENERATED DRAWING  
DO NOT MAKE MANUAL REVISIONS TO MASTER.

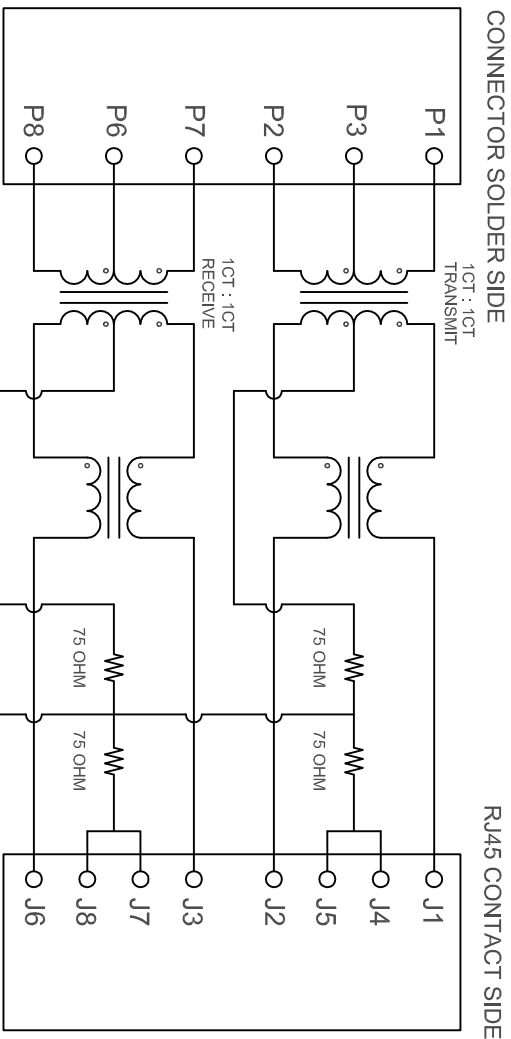
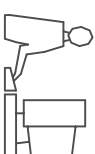

LED CIRCUIT:

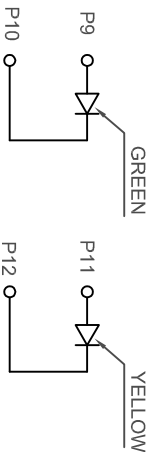

LED SPECIFICATIONS (WITH FORWARD CURRENT OF 20 mA)

STANDARD LED	WAVELENGTH	FORWARD V (MAX)	TYP
GREEN	565 nm	2.4 V	2.2 V
YELLOW	590 nm	2.5 V	2.1 V

TEST NOTES:(25±5°C)

- 1.T.R:(100KHz,0.1V):  
PINS:(P1-P2):(J1-J2)=1:1±3%  
PINS:(P7-P8):(J3-J6)=1:1±3%
- 2.LX:(100KHz,100mV,8mA, DC Bias)  
PINS: (P1,P2),(P7,P8)=350uH MINIMUM
- 3.DGR:  
PINS:(J1-J2),(J3-J6)= 1.2 OHMS MAXIMUM
- 4.HIPOT:  
PINS(P1,P2)TO(J1,J2)=1500VAC OR 2250VDC  
PINS(P7,P8)TO(J3,J6)=1500VAC OR 2250VDC
- 5.INSERTION LOSS:  
-1.2dB MAXIMUM AT 100KHz TO 100MHZ;
- 6.RETURN LOSS:  
-18dB MINIMUM AT 1MHz TO 30MHz;  
-(18-20log(f/30))dB MINIMUM AT 30MHz TO 60MHz  
-12dB MINIMUM AT 60MHz TO 80MHz
- 7.CROSS TALK:  
-35dB TYPICAL AT 1MHz TO 100MHz
- 8.COMMON TO COMMON MODE REJECTION:  
-30dB TYPICAL AT 30MHz TO 100MHz
9. LEAKAGE INDUCTANCE:  
PINS: P1-P2, WITH J1-J2 SHORTED=0.35 uH MAX @1MHz  
PINS: P7-P8, WITH J3-J6 SHORTED=0.35 uH MAX @1MHz
10. INTERWINDING CAPACITANCE:  
PINS:(P1-P2):(J1-J2)= 35 pF MAX @1MHz  
PINS:(P7-P8):(J3-J6)= 35 pF MAX @1MHz

RJ45 MAGNETIC JACK WITH LED, 8P, 8C  
SHIELDED/10/100 Mbps FILTER

ACAD REFERENCE NO.: A63-112-331P431

DRAWN: R.STA.MONICA DATE: NOV.19/2010

CHECKED: DATE:

PART NUMBER

SEE NOTE

SHEET 2 OF 2

DRAWING NUMBER

A63-112-331P431

ISSUE

2



THIS SERIES FULLY CONFORMS TO THE  
EUROPEAN UNION DIRECTIVES 2002/95/EC  
AND 2002/96/EC FOR ROHS COMPLIANCY.



EDAC INC  
TORONTO, ONTARIO  
CANADA

YOUR CONNECTION TO QUALITY & SERVICE

THESE DRAWINGS AND SPECIFICATIONS  
ARE THE PROPERTY OF EDAC INC. AND  
SHALL NOT BE REPRODUCED OR COPIED  
OR USED AS THE BASIS FOR THE  
MANUFACTURE OR SALE OF APPARATUS  
WITHOUT WRITTEN PERMISSION.