



# STP165N10F4

N-channel 100 V, 4.4 mΩ, 120 A TO-220  
STripFET™ DeepGATE™ Power MOSFET

## Features

Order code	V <sub>DSS</sub>	R <sub>DS(on)</sub> max	I <sub>D</sub>
STP165N10F4	100 V	< 5.5 mΩ	120 A

- N-channel enhancement mode
- 100% avalanche rated
- Low gate charge
- Very low on-resistance

## Application

Switching applications

## Description

The STP165N10F4 is an N-channel enhancement mode Power MOSFET built with STripFET™ DeepGATE™ technology with a new gate structure. The product is tailored to minimize on-resistance.

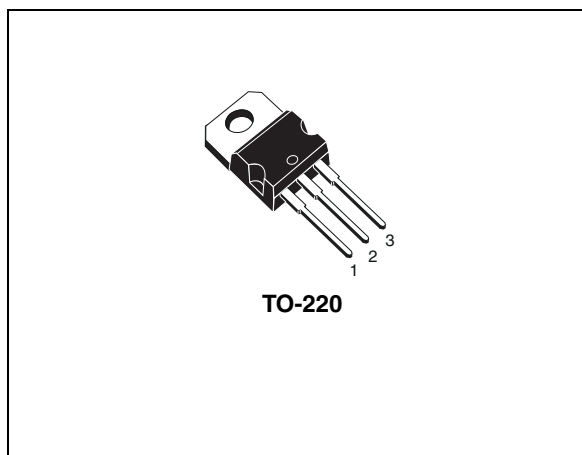

Figure 1. Internal schematic diagram

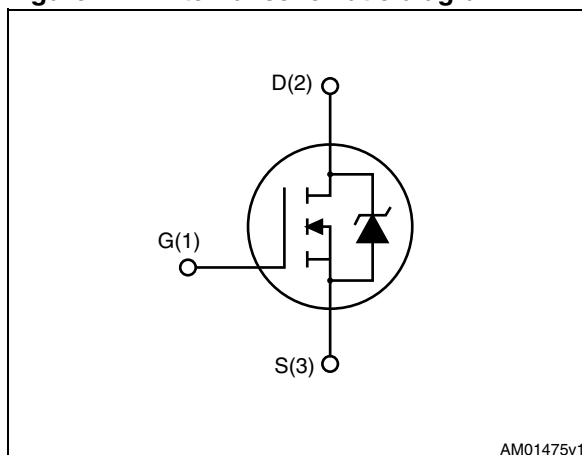

Table 1. Device summary

Order code	Marking	Package	Packaging
STP165N10F4	165N10F4	TO-220	Tube

# Contents

<b>1</b>	<b>Electrical ratings</b> .....	<b>3</b>
<b>2</b>	<b>Electrical characteristics</b> .....	<b>4</b>
2.1	Electrical characteristics (curves) .....	6
<b>3</b>	<b>Test circuits</b> .....	<b>8</b>
<b>4</b>	<b>Package mechanical data</b> .....	<b>9</b>
<b>5</b>	<b>Revision history</b> .....	<b>11</b>

# 1 Electrical ratings

**Table 2. Absolute maximum ratings**

Symbol	Parameter	Value	Unit
$V_{DS}$	Drain-source voltage ( $V_{GS} = 0$ )	100	V
$V_{GS}$	Gate- source voltage	$\pm 20$	V
$I_D$	Drain current (continuous) at $T_C = 25\text{ }^\circ\text{C}$	120	A
$I_D$	Drain current (continuous) at $T_C = 100\text{ }^\circ\text{C}$	110	A
$I_{DM}^{(1)}$	Drain current (pulsed)	480	A
$P_{TOT}$	Total dissipation at $T_C = 25\text{ }^\circ\text{C}$	315	W
	Derating factor	2.1	W/ $^\circ\text{C}$
$E_{AS}^{(2)}$	Single pulse avalanche energy	500	mJ
$T_{stg}$	Storage temperature	- 55 to 150	$^\circ\text{C}$
$T_j$	Max. operating junction temperature	150	

1. Pulse width limited by safe operating area
2. Starting  $T_j = 25\text{ }^\circ\text{C}$ ,  $I_D = 58\text{ A}$ ,  $V_{DD} = 50\text{ V}$

**Table 3. Thermal data**

Symbol	Parameter	Value	Unit
$R_{thj-case}$	Thermal resistance junction-case max	0.48	$^\circ\text{C}/\text{W}$
$R_{thj-a}$	Thermal resistance junction-ambient max	62.5	$^\circ\text{C}/\text{W}$
$T_l$	Maximum lead temperature for soldering purpose	315	$^\circ\text{C}$

## 2 Electrical characteristics

( $T_{CASE}=25^{\circ}\text{C}$  unless otherwise specified)

**Table 4. On/off states**

Symbol	Parameter	Test conditions	Min.	Typ.	Max.	Unit
$V_{(BR)DSS}$	Drain-source Breakdown voltage	$I_D = 250 \mu\text{A}$ , $V_{GS} = 0$	100			V
$I_{DSS}$	Zero gate voltage Drain current ( $V_{GS} = 0$ )	$V_{DS} = \text{max rating}$ $V_{DS} = \text{max rating}$ , $T_C = 125^{\circ}\text{C}$			1 100	$\mu\text{A}$ $\mu\text{A}$
$I_{GSS}$	Gate-body leakage current ( $V_{DS} = 0$ )	$V_{GS} = \pm 20 \text{ V}$			100	nA
$V_{GS(th)}$	Gate threshold voltage	$V_{DS} = V_{GS}$ , $I_D = 250 \mu\text{A}$	2		4	V
$R_{DS(on)}$	Static drain-source on resistance	$V_{GS} = 10 \text{ V}$ , $I_D = 60 \text{ A}$		4.4	5.5	$\text{m}\Omega$

**Table 5. Dynamic**

Symbol	Parameter	Test conditions	Min.	Typ.	Max.	Unit
$C_{iss}$	Input capacitance			10750		pF
$C_{oss}$	Output capacitance	$V_{DS} = 25 \text{ V}$ , $f = 1 \text{ MHz}$ , $V_{GS} = 0$	-	939	-	pF
$C_{rss}$	Reverse transfer capacitance			603		pF
$Q_g$	Total gate charge	$V_{DD} = 50 \text{ V}$ , $I_D = 120 \text{ A}$ , $V_{GS} = 10 \text{ V}$ <i>(see Figure 14)</i>		192		nC
$Q_{gs}$	Gate-source charge		-	48	-	nC
$Q_{gd}$	Gate-drain charge			62		nC

**Table 6. Switching times**

Symbol	Parameter	Test conditions	Min.	Typ.	Max.	Unit
$t_{d(on)}$ $t_r$	Turn-on delay time Rise time	$V_{DD} = 50\text{ V}$ , $I_D = 60\text{ A}$ $R_G = 4.7\ \Omega$ , $V_{GS} = 10\text{ V}$ (see Figure 13)	-	29.6 62	-	ns ns
$t_{d(off)}$ $t_f$	Turn-off-delay time Fall time	$V_{DD} = 50\text{ V}$ , $I_D = 60\text{ A}$ , $R_G = 4.7\ \Omega$ , $V_{GS} = 10\text{ V}$ (see Figure 13)	-	154 106	-	ns ns

**Table 7. Source drain diode**

Symbol	Parameter	Test conditions	Min.	Typ.	Max.	Unit
$I_{SD}$	Source-drain current		-		120	A
$I_{SDM}^{(1)}$	Source-drain current (pulsed)		-		480	A
$V_{SD}^{(2)}$	Forward on voltage	$I_{SD} = 120\text{ A}$ , $V_{GS} = 0$	-		1.4	V
$t_{rr}$ $Q_{rr}$ $I_{RRM}$	Reverse recovery time Reverse recovery charge Reverse recovery current	$I_{SD} = 120\text{ A}$ , $V_{DD} = 80\text{ V}$ $di/dt = 100\text{ A}/\mu\text{s}$ , $T_j = 150\text{ }^\circ\text{C}$ (see Figure 15)	-	86.8 313 7.2		ns nC A

1. Pulse width limited by safe operating area.
2. Pulsed: Pulse duration = 300  $\mu\text{s}$ , duty cycle 1.5%

## 2.1 Electrical characteristics (curves)

Figure 2. Safe operating area

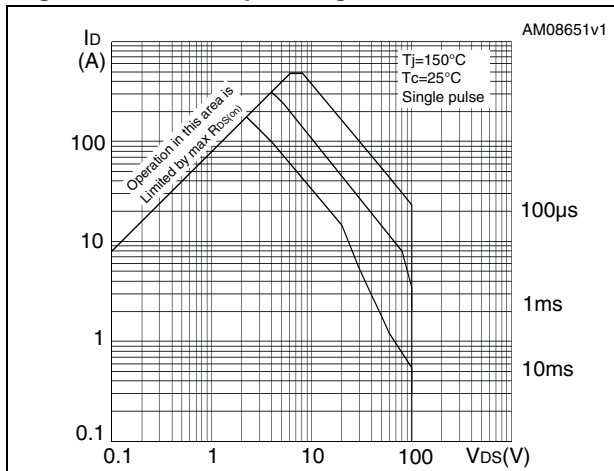

Figure 3. Thermal impedance

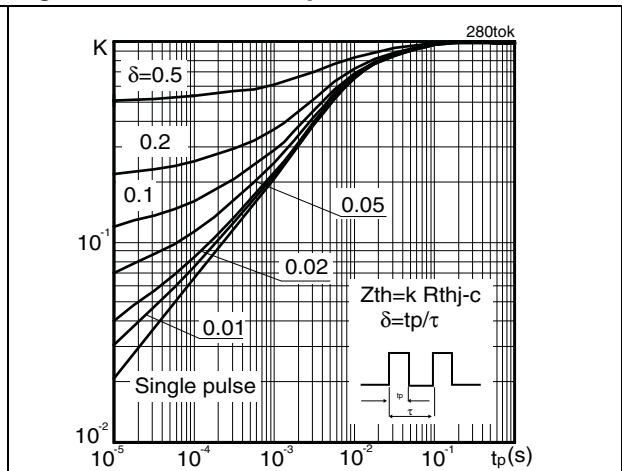

Figure 4. Output characteristics

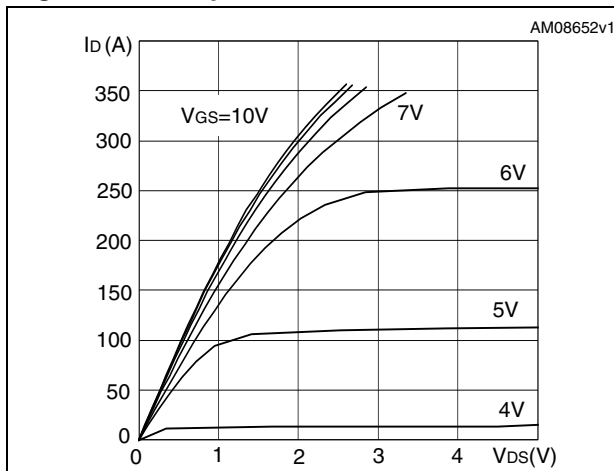

Figure 5. Transfer characteristics

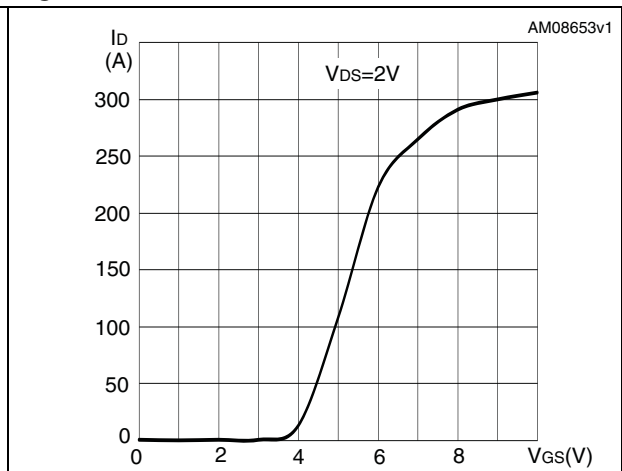

Figure 6. Normalized  $B_{V_{DSS}}$  vs temperature

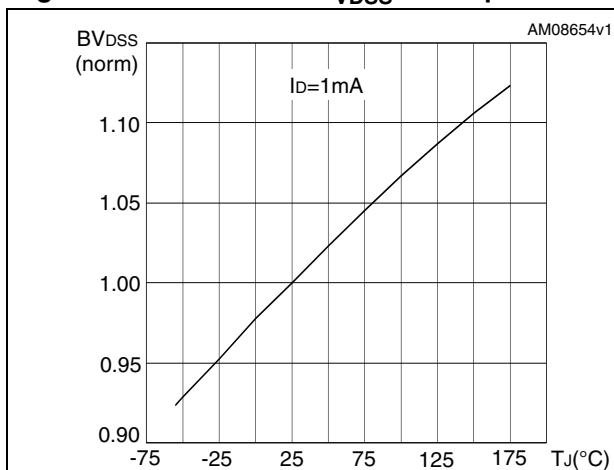

Figure 7. Static drain-source on resistance

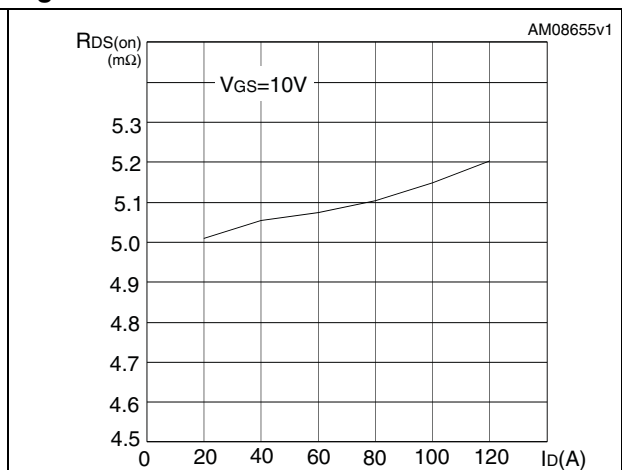

Figure 8. Gate charge vs gate-source voltage Figure 9. Capacitance variations

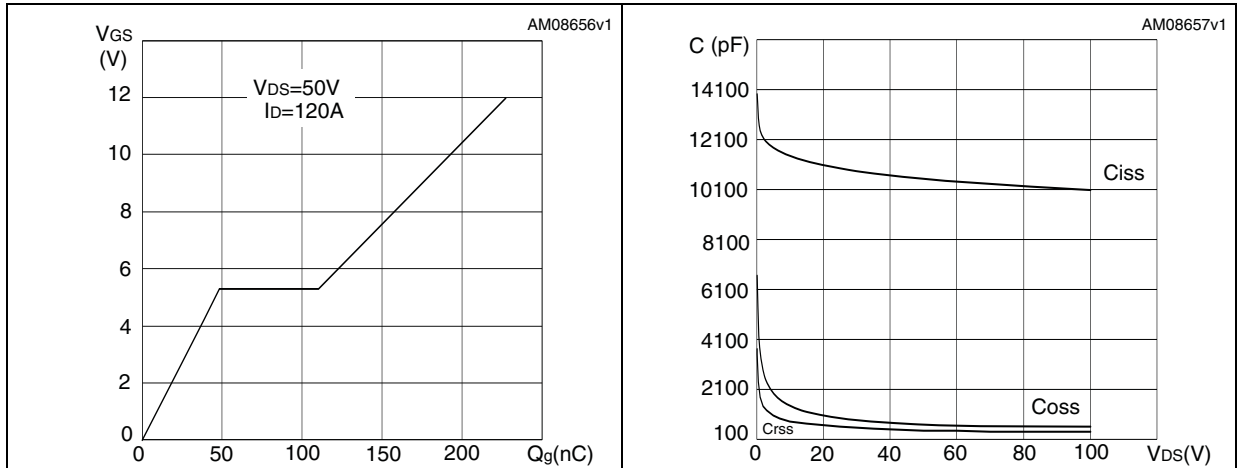

Figure 10. Normalized gate threshold voltage vs temperature Figure 11. Normalized on resistance vs temperature

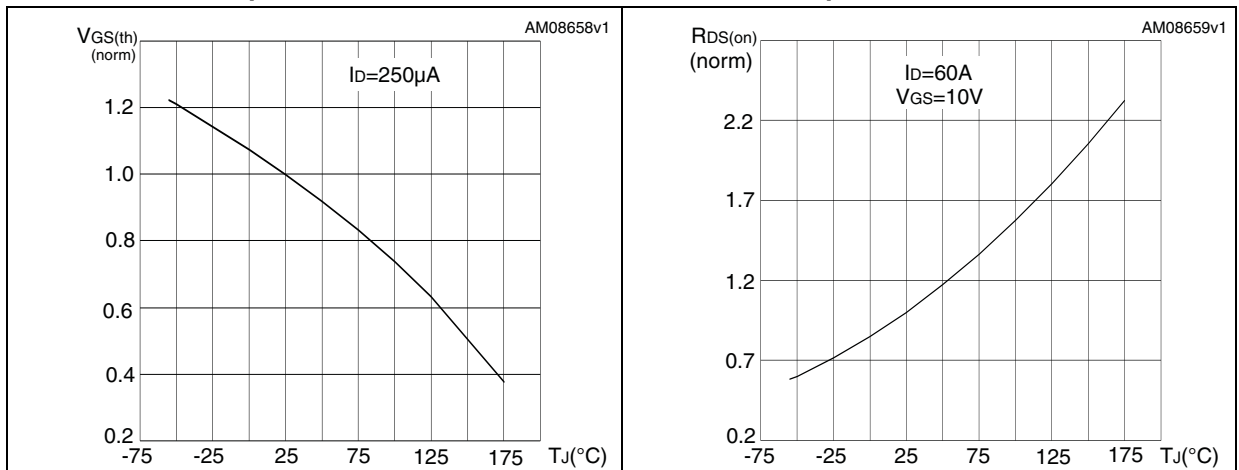
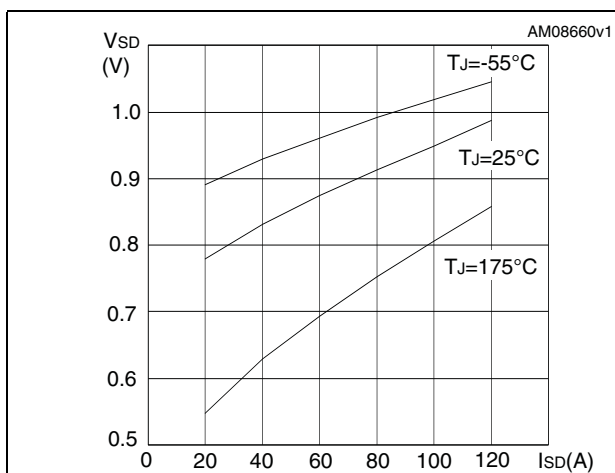

Figure 12. Source-drain diode forward characteristics



### 3 Test circuits

**Figure 13. Switching times test circuit for resistive load**



**Figure 14. Gate charge test circuit**



**Figure 15. Test circuit for inductive load switching and diode recovery times**



**Figure 16. Unclamped inductive load test circuit**



**Figure 17. Unclamped inductive waveform**

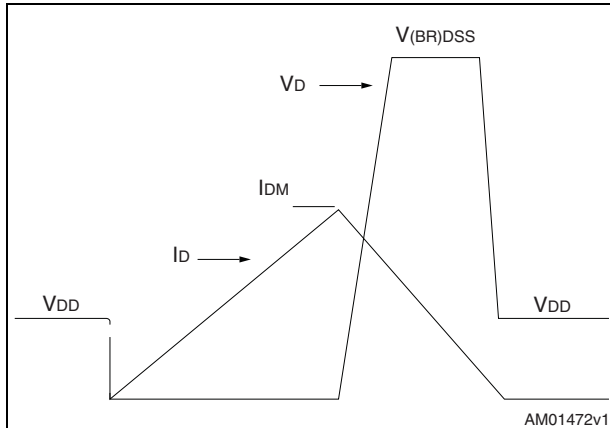

**Figure 18. Switching time waveform**

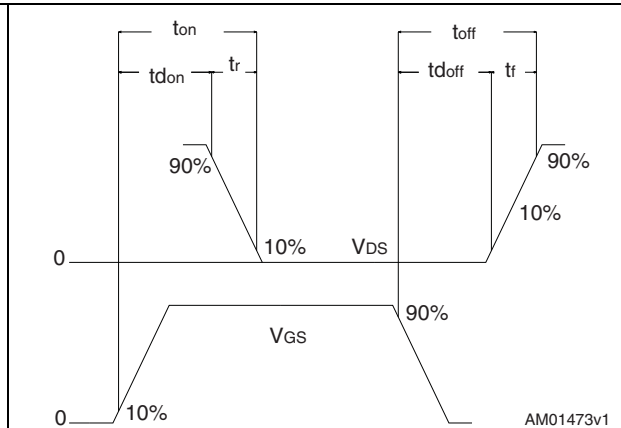



## 4 Package mechanical data

In order to meet environmental requirements, ST offers these devices in different grades of ECOPACK<sup>®</sup> packages, depending on their level of environmental compliance. ECOPACK<sup>®</sup> specifications, grade definitions and product status are available at: [www.st.com](http://www.st.com). ECOPACK is an ST trademark.

**TO-220 type A mechanical data**

Dim	mm		
	Min	Typ	Max
A	4.40		4.60
b	0.61		0.88
b1	1.14		1.70
c	0.48		0.70
D	15.25		15.75
D1		1.27	
E	10		10.40
e	2.40		2.70
e1	4.95		5.15
F	1.23		1.32
H1	6.20		6.60
J1	2.40		2.72
L	13		14
L1	3.50		3.93
L20		16.40	
L30		28.90	
∅P	3.75		3.85
Q	2.65		2.95

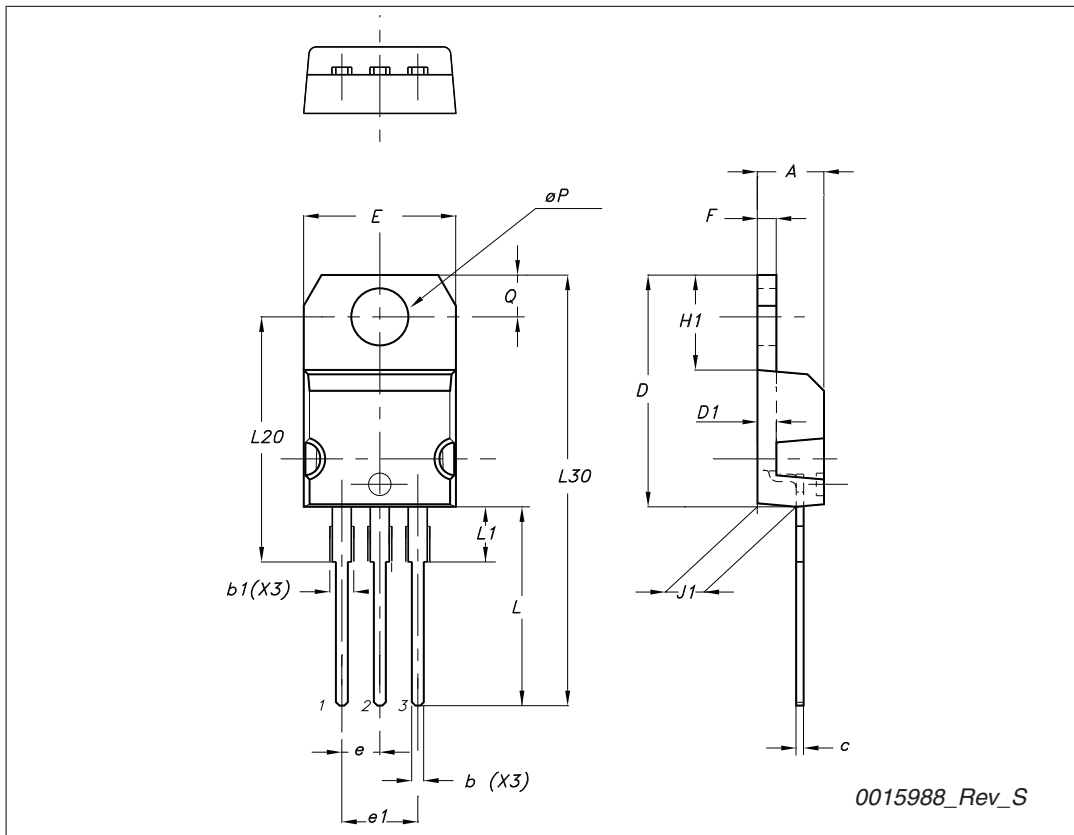

## 5 Revision history

**Table 8. Document revision history**

Date	Revision	Changes
19-May-2009	1	First release
12-Nov-2010	2	– Removed package H <sup>2</sup> PAK. – Document status promoted from preliminary data to datasheet.

**Please Read Carefully:**

Information in this document is provided solely in connection with ST products. STMicroelectronics NV and its subsidiaries ("ST") reserve the right to make changes, corrections, modifications or improvements, to this document, and the products and services described herein at any time, without notice.

All ST products are sold pursuant to ST's terms and conditions of sale.

Purchasers are solely responsible for the choice, selection and use of the ST products and services described herein, and ST assumes no liability whatsoever relating to the choice, selection or use of the ST products and services described herein.

No license, express or implied, by estoppel or otherwise, to any intellectual property rights is granted under this document. If any part of this document refers to any third party products or services it shall not be deemed a license grant by ST for the use of such third party products or services, or any intellectual property contained therein or considered as a warranty covering the use in any manner whatsoever of such third party products or services or any intellectual property contained therein.

**UNLESS OTHERWISE SET FORTH IN ST'S TERMS AND CONDITIONS OF SALE ST DISCLAIMS ANY EXPRESS OR IMPLIED WARRANTY WITH RESPECT TO THE USE AND/OR SALE OF ST PRODUCTS INCLUDING WITHOUT LIMITATION IMPLIED WARRANTIES OF MERCHANTABILITY, FITNESS FOR A PARTICULAR PURPOSE (AND THEIR EQUIVALENTS UNDER THE LAWS OF ANY JURISDICTION), OR INFRINGEMENT OF ANY PATENT, COPYRIGHT OR OTHER INTELLECTUAL PROPERTY RIGHT.**

**UNLESS EXPRESSLY APPROVED IN WRITING BY AN AUTHORIZED ST REPRESENTATIVE, ST PRODUCTS ARE NOT RECOMMENDED, AUTHORIZED OR WARRANTED FOR USE IN MILITARY, AIR CRAFT, SPACE, LIFE SAVING, OR LIFE SUSTAINING APPLICATIONS, NOR IN PRODUCTS OR SYSTEMS WHERE FAILURE OR MALFUNCTION MAY RESULT IN PERSONAL INJURY, DEATH, OR SEVERE PROPERTY OR ENVIRONMENTAL DAMAGE. ST PRODUCTS WHICH ARE NOT SPECIFIED AS "AUTOMOTIVE GRADE" MAY ONLY BE USED IN AUTOMOTIVE APPLICATIONS AT USER'S OWN RISK.**

Resale of ST products with provisions different from the statements and/or technical features set forth in this document shall immediately void any warranty granted by ST for the ST product or service described herein and shall not create or extend in any manner whatsoever, any liability of ST.

ST and the ST logo are trademarks or registered trademarks of ST in various countries.

Information in this document supersedes and replaces all information previously supplied.

The ST logo is a registered trademark of STMicroelectronics. All other names are the property of their respective owners.

© 2010 STMicroelectronics - All rights reserved

STMicroelectronics group of companies

Australia - Belgium - Brazil - Canada - China - Czech Republic - Finland - France - Germany - Hong Kong - India - Israel - Italy - Japan - Malaysia - Malta - Morocco - Philippines - Singapore - Spain - Sweden - Switzerland - United Kingdom - United States of America

[www.st.com](http://www.st.com)