

Middle Power LED Series
5630

LM561B Plus

CRI 90



Improved efficacy and performance of LM561B to provide better solution



Features & Benefits

- 0.3 W class middle power LED
- Mold resin for high reliability
- Standard form factor for design flexibility (5.6 × 3.0 mm)

Table of Contents

1.	Characteristics	-----	3
2.	Product Code Information	-----	5
3.	Typical Characteristics Graphs	-----	20
4.	Outline Drawing & Dimension	-----	23
5.	Reliability Test Items & Conditions	-----	24
6.	Soldering Conditions	-----	25
7.	Tape & Reel	-----	26
8.	Label Structure	-----	28
9.	Packing Structure	-----	29
10.	Precautions in Handling & Use	-----	34

1. Characteristics

a) Absolute Maximum Rating

Item	Symbol	Rating	Unit	Condition
Ambient / Operating Temperature	T_a	-40 ~ +85	°C	-
Storage Temperature	T_{stg}	-40 ~ +120	°C	-
LED Junction Temperature	T_j	110	°C	-
Forward Current	I_F	180	mA	-
Peak Pulsed Forward Current	I_{fp}	300	mA	Duty 1/10, pulse width 10 ms
Assembly Process Temperature	-	260 <10	°C s	-
ESD (HBM)	-	±5	kV	-

b) Electro-optical Characteristics ($I_F = 65 \text{ mA}$, $T_s = 25 \text{ }^\circ\text{C}$)

Item	Unit	CRI (R_a) Min.	Nominal CCT (K)	Rank	Bin	Min.	Typ.	Max.					
Forward Voltage (V_F)	V			WA	AZ	2.7	-	2.8					
					A1	2.8	-	2.9					
					A2	2.9	-	3.0					
					A3	3.0	-	3.1					
					A4	3.1	-	3.2					
					Luminous Flux (Φ_v)	lm	90	2700		S1	24.0	-	26.0
										S2	26.0	-	28.0
										S3	28.0	-	30.0
								3000		S1	24.5	-	26.5
										S2	26.5	-	28.5
										S3	28.5	-	30.5
								3500		S1	25.0	-	27.0
S2	27.0	-	29.0										
S3	29.0	-	31.0										
Luminous Flux (Φ_v)	lm	90	4000		S1	26.0	-	28.0					
					S2	28.0	-	30.0					
					S3	30.0	-	32.0					
			5000		S1	27.0	-	29.0					
					S2	29.0	-	31.0					
					S3	31.0	-	33.0					
			5700		S1	26.5	-	28.5					
					S2	28.5	-	30.5					
					S3	30.5	-	32.5					
6500	S1	26.0	-	28.0									
	S2	28.0	-	30.0									
	S3	30.0	-	32.0									
Reverse Voltage (@ 5 mA)	V					0.7	-	1.2					
Color Rendering Index (R_a)	-					90	-	-					
Special CRI (R9)	-					50	-	-					
Thermal Resistance (junction to solder point)	$^\circ\text{C/W}$					-	15	-					
Beam Angle	$^\circ$					-	120	-					

Note:

Samsung maintains measurement tolerance of: forward voltage = $\pm 0.1 \text{ V}$, luminous flux = $\pm 5 \%$, CRI = ± 3 , R9 = ± 6.5

2. Product Code Information

1	2	3	4	5	6	7	8	9	10	11	12	13	14	15	16	17	18
S	P	M	W	H	T	5	4	1	M	P	7	W	A	R	0	S	1

Digit	PKG Information	Code	Specification	
1 2 3	Samsung Package Middle Power	SPM		
4 5	Color	WH	White	
6	Product Version	T		
7 8 9	Form Factor	541	5.6 x 3.0 x 0.7 mm; 4 pads;	
10	Sorting Current (mA)	M	65 mA	
11	Chromaticity Coordinates	P		
12	CRI	7	Min. 90	
13 14	Forward Voltage (V)	WA	2.7~3.2V (2,500 pcs/Reel)	
15 16	CCT (K)	W ☆ 2700 V ☆ 3000 U ☆ 3500 T ☆ 4000 R ☆ 5000 Q ☆ 5700 P ☆ 6500	Bin Code: W1, W2, W3, W4, W5, W6, W7, W8, W9, WA, WB, WC, WD, WE, WF, WG V1, V2, V3, V4, V5, V6, V7, V8, V9, VA, VB, VC, VD, VE, VF, VG U1, U2, U3, U4, U5, U6, U7, U8, U9, UA, UB, UC, UD, UE, UF, UG T1, T2, T3, T4, T5, T6, T7, T8, T9, TA, TB, TC, TD, TE, TF, TG R1, R2, R3, R4, R5, R6, R7, R8, R9, RA, RB, RC, RP, RQ, RR, RS Q1, Q2, Q3, Q4, Q5, Q6, Q7, Q8, Q9, QA, QB, QC, QP, QQ, QR, QS P1, P2, P3, P4, P5, P6, P7, P8, P9, PA, PB, PC, PP, PQ, PR, PS	☆ "0" (Whole bin) "M" (Quarter bin) "K" (K Kitting) or "S" (S Kitting)
17 18	Luminous Flux	S0	Bin Code:	S1, S2, S3

a) Luminous Flux Bins($I_F = 65 \text{ mA}$, $T_s = 25^\circ\text{C}$)

CRI (R_a) Min.	Nominal CCT (K)	Product Code	Flux Bin	Flux Range (Φ_v , lm)
90	2700	SPMWHT541MP7WAW☆S0	S1	24.0 ~ 26.0
			S2	26.0 ~ 28.0
			S3	28.0 ~ 30.0
	3000	SPMWHT541MP7WAV☆S0	S1	24.5 ~ 26.5
			S2	26.5 ~ 28.5
			S3	28.5 ~ 30.5
	3500	SPMWHT541MP7WAU☆S0	S1	25.0 ~ 27.0
			S2	27.0 ~ 29.0
			S3	29.0 ~ 31.0
	4000	SPMWHT541MP7WAT☆S0	S1	26.0 ~ 28.0
			S2	28.0 ~ 30.0
			S3	30.0 ~ 32.0
	5000	SPMWHT541MP7WAR☆S0	S1	27.0 ~ 29.0
			S2	29.0 ~ 31.0
			S3	31.0 ~ 33.0
	5700	SPMWHT541MP7WAQ☆S0	S1	26.5 ~ 28.5
			S2	28.5 ~ 30.5
			S3	30.5 ~ 32.5
6500	SPMWHT541MP7WAP☆S0	S1	26.0 ~ 28.0	
		S2	28.0 ~ 30.0	
		S3	30.0 ~ 32.0	

Note:

"◆" can be "A" (2,500pcs) of reel taping

"☆" can be "0" (Whole bin), "M" (Quarter bin), "K" (K Kitting) or "S" (S Kitting) of the color binning

b) Kitting rule

1) K Kitting bin Concept

1. Under agreement between customer and SAMSUNG ELECTRONICS, SAMSUNG can supply kitting bin (VF, Color, Im).
2. A forward voltage (VF) of kitting bin is combined by a pair of same VF rank such as (A1+A1), (A2+A2), (A3+A3), (A4+A4) or (AZ+AZ).
3. A Chromaticity Coordinates of kitting bin is mixed by kitting procedure.(below kitting simulation)
4. A luminous flux(lm) of kitting bin is combined by a pair of IV rank such as (S1+S1), (S2+S2) or (S3+S3)

**[Kitting example ; Warm white]
(2700K, 3000K, 3500K, 4000K)**

D	Y	E	F	Z	G
9	A	V	B	C	
5	6	7	8		
1	W	2	3	X	4

**[Kitting example ; Cool white]
(5000K, 5700K, 6500K)**

9	Y	A	B	Z	C
5	6	V	7	8	
1	2	3	4		
P	W	Q	R	X	S

[Binning Information]

	Warm white		Cool white	
	Bin #1	Bin #2	Bin #1	Bin #2
VF	AZ	AZ	AZ	AZ
	A1	A1	A1	A1
	A2	A2	A2	A2
	A3	A3	A3	A3
	A4	A4	A4	A4
CIE	W (1, 2, 5, 6 bin)	Z (B, C, F, G bin)	W (1, 2, P, Q bin)	Z (7, 8, B, C bin)
	V (6, 7, A, B bin)	V (6, 7, A, B bin)	V (2, 3, 6, 7 bin)	V (2, 3, 6, 7 bin)
	X (3, 4, 7, 8 bin)	Y (9, A, D, E bin)	X (3, 4, R, S bin)	Y (5, 6, 9, A bin)
IV	S1	S1	S1	S1
	S2	S2	S2	S2
	S3	S3	S3	S3

※ Each of V,W,X,Y and Z can be one bin without details division

2) S Kitting bin Concept

- Under agreement between customer and SAMSUNG ELECTRONICS, SAMSUNG can supply kitting bin (VF, Color, Im).
- A forward voltage (VF) of kitting bin is combined by a pair of same VF rank such as (A1+A1), (A2+A2), (A3+A3), (A4+A4) or (AZ+AZ).
- A Chromaticity Coordinates of kitting bin is mixed by kitting procedure.(below kitting simulation)
- A luminous flux(lm) of kitting bin is combined by a pair of IV rank such as (S1+S1), (S2+S2) or (S3+S3)

[Kitting example ; Warm white]
(2700K, 3000K, 3500K, 4000K)

D	Y	E	F	Z	G
9	A	B	C		
5	6	7		8	
1	W	2	3	X	4

[Kitting example ; Cool white]
(5000K, 5700K, 6500K)

9	Y	A	B	Z	C
5	6	7	8		
1	2	3	4		
P	W	Q	R	X	S

[Binning Information]

	Warm white		Cool white	
	Bin #1	Bin #2	Bin #1	Bin #2
VF	AZ	AZ	AZ	AZ
	A1	A1	A1	A1
	A2	A2	A2	A2
	A3	A3	A3	A3
	A4	A4	A4	A4
CIE	W (1, 2, 5)	B	W (1, P, Q)	7
	X (3, 4, 8)	A	X (4, R, S)	6
	Y (9, D, E)	7	Y (5, 9, A)	3
	Z (C, F, G)	6	Z (8, B, C)	2
	6	6	2	2
	7	7	3	3
	A	A	6	6
	B	B	7	7
V (6, 7, A, B)	V (6, 7, A, B)	V (2, 3, 6, 7)	V (2, 3, 6, 7)	
IV	S1	S1	S1	S1
	S2	S2	S2	S2
	S3	S3	S3	S3

※ Each of V,W,X,Y and Z can be one bin without details division.

c) Color Bins ($I_F = 65 \text{ mA}$, $T_s = 25 \text{ }^\circ\text{C}$)

CRI (R_a) Min.	Nominal CCT (K)	Product Code	Color Rank	Chromaticity Bins
80	2700	SPMWHT541MP7XAW0S0	W0 (Whole bin)	W1, W2, W3, W4, W5, W6, W7, W8, W9, WA, WB, WC, WD, WE, WF, WG
		SPMWHT541MP7XAWM0	WM (Quarter bin)	W6, W7, WA, WB
		SPMWHT541MP7XAWSS0	WS (S Kitting)	W6, W7, WA, WB, WV, WW, WX, WY, WZ
		SPMWHT541MP7XAWK0	WK (K Kitting)	WV, WW, WX, WY, WZ
	3000	SPMWHT541MP7XAV0S0	V0 (Whole bin)	V1, V2, V3, V4, V5, V6, V7, V8, V9, VA, VB, VC, VD, VE, VF, VG
		SPMWHT541MP7XAVMS0	VM (Quarter bin)	V6, V7, VA, VB
		SPMWHT541MP7XAVSS0	VS (S Kitting)	V6, V7, VA, VB, VV, VW, VX, VY, VZ
		SPMWHT541MP7XAVKS0	VK (K Kitting)	VV, VW, VX, VY, VZ
	3500	SPMWHT541MP7XAU0S0	U0 (Whole bin)	U1, U2, U3, U4, U5, U6, U7, U8, U9, UA, UB, UC, UD, UE, UF, UG
		SPMWHT541MP7XAUMS0	UM (Quarter bin)	U6, U7, UA, UB
		SPMWHT541MP7XAUSS0	US (S Kitting)	U6, U7, UA, UB, UV, UW, UX, UY, UZ
		SPMWHT541MP7XAUKS0	UK (K Kitting)	UV, UW, UX, UY, UZ
	4000	SPMWHT541MP7XAT0S0	T0 (Whole bin)	T1, T2, T3, T4, T5, T6, T7, T8, T9, TA, TB, TC, TD, TE, TF, TG
		SPMWHT541MP7XATMS0	TM (Quarter bin)	T6, T7, TA, TB
		SPMWHT541MP7XATSS0	TS (S Kitting)	T6, T7, TA, TB, TV, TW, TX, TY, TZ
		SPMWHT541MP7XATKS0	TK (K Kitting)	TV, TW, TX, TY, TZ
5000	SPMWHT541MP7XAR0S0	R0 (Whole bin)	R1, R2, R3, R4, R5, R6, R7, R8, R9, RA, RB, RC, RD, RE, RF, RG	
	SPMWHT541MP7XARMS0	RM (Quarter bin)	R6, R7, RA, RB	
	SPMWHT541MP7XARSS0	RS (S Kitting)	R6, R7, RA, RB, RV, RW, RX, RY, RZ	
	SPMWHT541MP7XARKS0	RK (K Kitting)	RV, RW, RX, RY, RZ	
5700	SPMWHT541MP7XAQ0S0	Q0 (Whole bin)	Q1, Q2, Q3, Q4, Q5, Q6, Q7, Q8, Q9, QA, QB, QC, QD, QE, QF, QG	
	SPMWHT541MP7XAQMS0	QM (Quarter bin)	Q6, Q7, QA, QB	
	SPMWHT541MP7XAQSS0	QS (S Kitting)	Q6, Q7, QA, QB, QV, QW, QX, QY, QZ	
	SPMWHT541MP7XAQKS0	QK (K Kitting)	QV, QW, QX, QY, QZ	

6500	SPMWHT541MP7XAP0S0	P0 (Whole bin)	P1, P2, P3, P4, P5, P6, P7, P8, P9, PA, PB, PC, PD, PE, PF, PG
	SPMWHT541MP7XAPMS0	PM (Quarter bin)	P6, P7, PA, PB
	SPMWHT541MP7XAPSS0	PS (S Kitting)	P6, P7, PA, PB, PV, PW, PX, PY, PZ
	SPMWHT541MP7XAPKS0	PK (K Kitting)	PV, PW, PX, PY, PZ

d) Voltage Bins ($I_F = 65 \text{ mA}$, $T_s = 25 \text{ °C}$)

CRI (R_a) Min.	Nominal CCT (K)	Product Code	Voltage Rank	Voltage Bin	Voltage Range (V)
-	-	-	WA (WK)	AZ	2.7 ~ 2.8
-	-	-		A1	2.8 ~ 2.9
-	-	-		A2	2.9 ~ 3.0
-	-	-		A3	3.0 ~ 3.1
-	-	-		A4	3.1 ~ 3.2
-	-	-			

e) Chromaticity Region & Coordinates ($I_f = 65 \text{ mA}$, $T_s = 25 \text{ }^\circ\text{C}$)

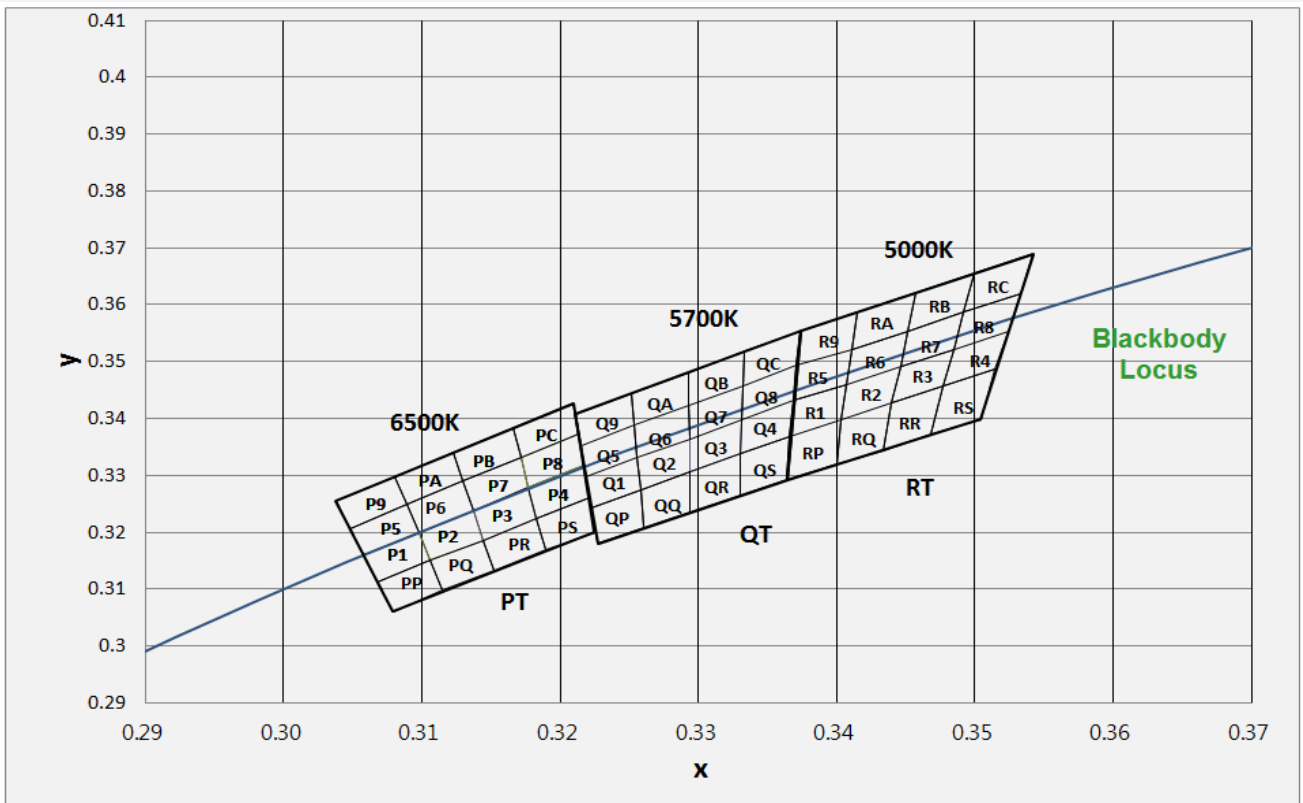
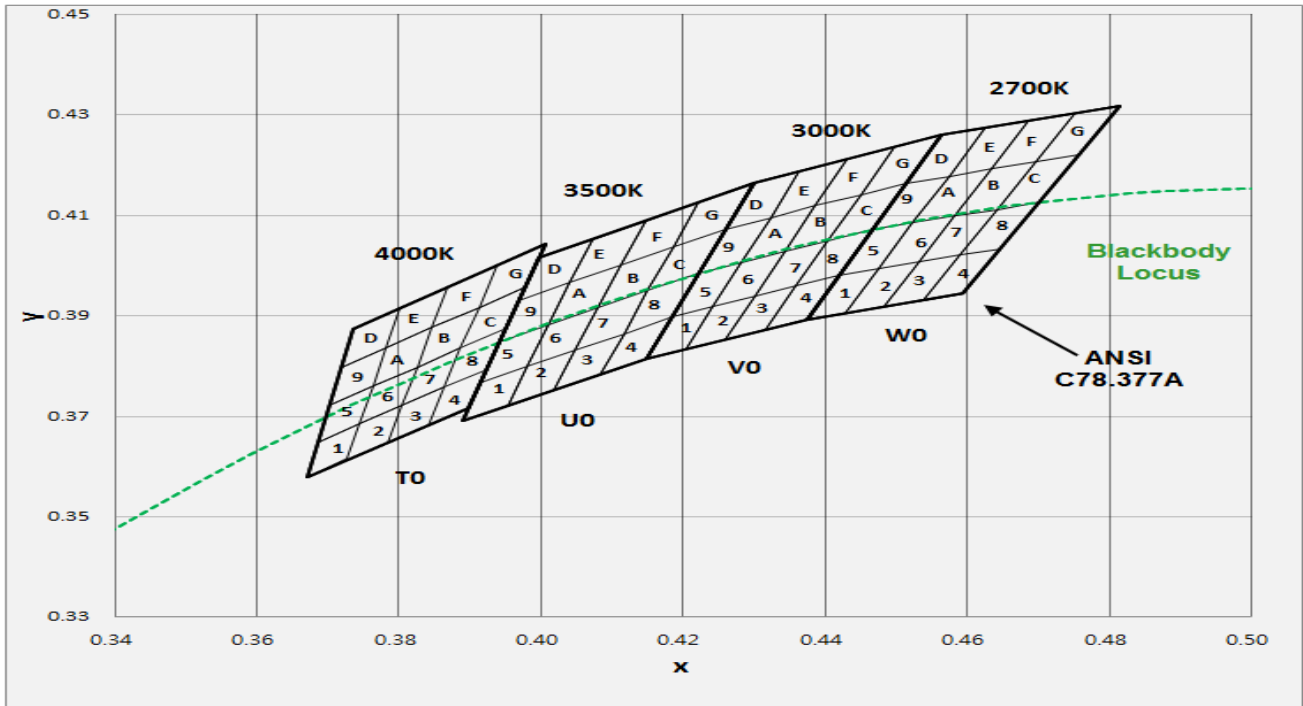

e) Chromaticity Region & Coordinates ($I_F = 65 \text{ mA}$, $T_s = 25 \text{ }^\circ\text{C}$)

Region	CIE x	CIE y	Region	CIE x	CIE y
W rank (2700 K)					
W1	0.4373	0.3893	W9	0.4465	0.4071
	0.4418	0.3981		0.4513	0.4164
	0.4475	0.3994		0.4573	0.4178
	0.4428	0.3906		0.4523	0.4085
W2	0.4428	0.3906	WA	0.4523	0.4085
	0.4475	0.3994		0.4573	0.4178
	0.4532	0.4008		0.4634	0.4193
	0.4483	0.3919		0.4582	0.4099
W3	0.4483	0.3919	WB	0.4582	0.4099
	0.4532	0.4008		0.4634	0.4193
	0.4589	0.4021		0.4695	0.4207
	0.4538	0.3931		0.4641	0.4112
W4	0.4538	0.3931	WC	0.4641	0.4112
	0.4589	0.4021		0.4695	0.4207
	0.4646	0.4034		0.4756	0.4221
	0.4593	0.3944		0.4700	0.4126
W5	0.4418	0.3981	WD	0.4513	0.4164
	0.4465	0.4071		0.4562	0.4260
	0.4523	0.4085		0.4624	0.4274
	0.4475	0.3994		0.4573	0.4178
W6	0.4475	0.3994	WE	0.4573	0.4178
	0.4523	0.4085		0.4624	0.4274
	0.4582	0.4099		0.4687	0.4289
	0.4532	0.4008		0.4634	0.4193
W7	0.4532	0.4008	WF	0.4634	0.4193
	0.4582	0.4099		0.4687	0.4289
	0.4641	0.4112		0.4750	0.4304
	0.4589	0.4021		0.4695	0.4207
W8	0.4589	0.4021	WG	0.4695	0.4207
	0.4641	0.4112		0.4750	0.4304
	0.4700	0.4126		0.4813	0.4319
	0.4646	0.4034		0.4756	0.4221

Region	CIE x	CIE y	Region	CIE x	CIE y
V rank (3000 K)					
V1	0.4147	0.3814	V9	0.4221	0.3984
	0.4183	0.3898		0.4259	0.4073
	0.4242	0.3919		0.4322	0.4096
	0.4203	0.3833		0.4281	0.4006
V2	0.4203	0.3833	VA	0.4281	0.4006
	0.4242	0.3919		0.4322	0.4096
	0.4300	0.3939		0.4385	0.4119
	0.4259	0.3853		0.4342	0.4028
V3	0.4259	0.3853	VB	0.4342	0.4028
	0.4300	0.3939		0.4385	0.4119
	0.4359	0.3960		0.4449	0.4141
	0.4316	0.3873		0.4403	0.4049
V4	0.4316	0.3873	VC	0.4403	0.4049
	0.4359	0.3960		0.4449	0.4141
	0.4418	0.3981		0.4513	0.4164
	0.4373	0.3893		0.4465	0.4071
V5	0.4183	0.3898	VD	0.4259	0.4073
	0.4221	0.3984		0.4299	0.4165
	0.4281	0.4006		0.4364	0.4188
	0.4242	0.3919		0.4322	0.4096
V6	0.4242	0.3919	VE	0.4322	0.4096
	0.4281	0.4006		0.4364	0.4188
	0.4342	0.4028		0.4430	0.4212
	0.4300	0.3939		0.4385	0.4119
V7	0.4300	0.3939	VF	0.4385	0.4119
	0.4342	0.4028		0.4430	0.4212
	0.4403	0.4049		0.4496	0.4236
	0.4359	0.3960		0.4449	0.4141
V8	0.4359	0.3960	VG	0.4449	0.4141
	0.4403	0.4049		0.4496	0.4236
	0.4465	0.4071		0.4562	0.4260
	0.4418	0.3981		0.4513	0.4164

e) Chromaticity Region & Coordinates

Region	CIE x	CIE y	Region	CIE x	CIE y
U rank (3500 K)					
U1	0.3889	0.3690	U9	0.3941	0.3848
	0.3915	0.3768		0.3968	0.3930
	0.3981	0.3800		0.4040	0.3966
	0.3953	0.3720		0.4010	0.3882
U2	0.3953	0.3720	UA	0.4010	0.3882
	0.3981	0.3800		0.4040	0.3966
	0.4048	0.3832		0.4113	0.4001
	0.4017	0.3751		0.4080	0.3916
U3	0.4017	0.3751	UB	0.4080	0.3916
	0.4048	0.3832		0.4113	0.4001
	0.4116	0.3865		0.4186	0.4037
	0.4082	0.3782		0.4150	0.3950
U4	0.4082	0.3782	UC	0.4150	0.3950
	0.4116	0.3865		0.4186	0.4037
	0.4183	0.3898		0.4259	0.4073
	0.4147	0.3814		0.4221	0.3984
U5	0.3915	0.3768	UD	0.3968	0.3930
	0.3941	0.3848		0.3996	0.4015
	0.4010	0.3882		0.4071	0.4052
	0.3981	0.3800		0.4040	0.3966
U6	0.3981	0.3800	UE	0.4040	0.3966
	0.4010	0.3882		0.4071	0.4052
	0.4080	0.3916		0.4146	0.4089
	0.4048	0.3832		0.4113	0.4001
U7	0.4048	0.3832	UF	0.4113	0.4001
	0.4080	0.3916		0.4146	0.4089
	0.4150	0.3950		0.4222	0.4127
	0.4116	0.3865		0.4186	0.4037
U8	0.4116	0.3865	UG	0.4186	0.4037
	0.4150	0.3950		0.4222	0.4127
	0.4221	0.3984		0.4299	0.4165
	0.4183	0.3898		0.4259	0.4073

Region	CIE x	CIE y	Region	CIE x	CIE y
T rank (4000 K)					
T1	0.3670	0.3578	T9	0.3702	0.3722
	0.3726	0.3612		0.3763	0.3760
	0.3744	0.3685		0.3782	0.3837
	0.3686	0.3649		0.3719	0.3797
T2	0.3726	0.3612	TA	0.3763	0.3760
	0.3783	0.3646		0.3825	0.3798
	0.3804	0.3721		0.3847	0.3877
	0.3744	0.3685		0.3782	0.3837
T3	0.3783	0.3646	TB	0.3825	0.3798
	0.3840	0.3681		0.3887	0.3836
	0.3863	0.3758		0.3912	0.3917
	0.3804	0.3721		0.3847	0.3877
T4	0.3840	0.3681	TC	0.3887	0.3837
	0.3898	0.3716		0.3950	0.3875
	0.3924	0.3794		0.3978	0.3958
	0.3863	0.3758		0.3912	0.3917
T5	0.3686	0.3649	TD	0.3719	0.3797
	0.3744	0.3685		0.3782	0.3837
	0.3763	0.3760		0.3802	0.3916
	0.3702	0.3722		0.3736	0.3874
T6	0.3744	0.3685	TE	0.3782	0.3837
	0.3804	0.3721		0.3847	0.3877
	0.3825	0.3798		0.3869	0.3958
	0.3763	0.376		0.3802	0.3916
T7	0.3804	0.3721	TF	0.3847	0.3877
	0.3863	0.3758		0.3912	0.3917
	0.3887	0.3836		0.3937	0.4001
	0.3825	0.3798		0.3869	0.3958
T8	0.3863	0.3758	TG	0.3912	0.3917
	0.3924	0.3794		0.3978	0.3958
	0.3950	0.3875		0.4006	0.4044
	0.3887	0.3836		0.3937	0.4001

e) Chromaticity Region & Coordinates

Region	CIE x	CIE y	Region	CIE x	CIE y
R rank (5000 K)					
R1	0.3366	0.3369	R9	0.3374	0.3554
	0.3369	0.3431		0.3371	0.3493
	0.3407	0.3460		0.3411	0.3522
	0.3403	0.3398		0.3415	0.3587
R2	0.3403	0.3398	RA	0.3415	0.3587
	0.3407	0.3460		0.3411	0.3522
	0.3446	0.3491		0.3451	0.3554
	0.3440	0.3427		0.3457	0.3621
R3	0.3446	0.3491	RB	0.3451	0.3554
	0.3440	0.3427		0.3457	0.3621
	0.3477	0.3458		0.3500	0.3655
	0.3485	0.3522		0.3492	0.3587
R4	0.3485	0.3522	RC	0.3492	0.3587
	0.3477	0.3458		0.3500	0.3655
	0.3514	0.3487		0.3542	0.3690
	0.3524	0.3554		0.3533	0.3620
R5	0.3371	0.3493	RP	0.3366	0.3369
	0.3369	0.3431		0.3364	0.3292
	0.3407	0.3460		0.3400	0.3320
	0.3411	0.3522		0.3403	0.3398
R6	0.3407	0.3460	RQ	0.3403	0.3398
	0.3411	0.3522		0.3400	0.3320
	0.3451	0.3554		0.3434	0.3344
	0.3446	0.3491		0.3440	0.3427
R7	0.3446	0.3491	RR	0.3440	0.3427
	0.3451	0.3554		0.3434	0.3344
	0.3492	0.3587		0.3468	0.3372
	0.3485	0.3522		0.3477	0.3458
R8	0.3485	0.3522	RS	0.3477	0.3458
	0.3492	0.3587		0.3468	0.3372
	0.3533	0.3620		0.3504	0.3398
	0.3524	0.3554		0.3514	0.3487

Region	CIE x	CIE y	Region	CIE x	CIE y
Q rank (5700 K)					
Q1	0.3218	0.3298	Q9	0.3211	0.3407
	0.3222	0.3243		0.3215	0.3353
	0.3258	0.3275		0.3254	0.3388
	0.3256	0.3331		0.3252	0.3444
Q2	0.3256	0.3331	QA	0.3252	0.3444
	0.3258	0.3275		0.3254	0.3388
	0.3294	0.3306		0.3293	0.3423
	0.3294	0.3364		0.3293	0.3481
Q3	0.3294	0.3364	QB	0.3293	0.3481
	0.3294	0.3306		0.3293	0.3423
	0.3330	0.3338		0.3332	0.3458
	0.3331	0.3398		0.3333	0.3518
Q4	0.3331	0.3398	QC	0.3333	0.3518
	0.3330	0.3338		0.3332	0.3458
	0.3366	0.3369		0.3371	0.3493
	0.3369	0.3431		0.3374	0.3554
Q5	0.3215	0.3353	QP	0.3222	0.3243
	0.3218	0.3298		0.3227	0.3180
	0.3256	0.3331		0.3260	0.3208
	0.3254	0.3388		0.3258	0.3275
Q6	0.3254	0.3388	QQ	0.3258	0.3275
	0.3256	0.3331		0.3260	0.3208
	0.3294	0.3364		0.3294	0.3235
	0.3293	0.3423		0.3294	0.3306
Q7	0.3293	0.3423	QR	0.3294	0.3306
	0.3294	0.3364		0.3294	0.3235
	0.3331	0.3398		0.3330	0.3266
	0.3332	0.3458		0.3330	0.3338
Q8	0.3332	0.3458	QS	0.3330	0.3338
	0.3331	0.3398		0.3330	0.3266
	0.3369	0.3431		0.3364	0.3292
	0.3371	0.3493		0.3366	0.3369

e) Chromaticity Region & Coordinates

Region	CIE x	CIE y	Region	CIE x	CIE y
P rank (6500 K)					
PP	0.3079	0.3060	P5	0.3058	0.316
	0.3115	0.3098		0.3098	0.3199
	0.3106	0.3150		0.3089	0.3249
	0.3068	0.3113		0.3048	0.3207
PQ	0.3115	0.3098	P6	0.3098	0.3199
	0.3152	0.3133		0.3137	0.3238
	0.3144	0.3186		0.313	0.329
	0.3106	0.3150		0.3089	0.3249
PR	0.3152	0.3133	P7	0.3137	0.3238
	0.3190	0.3170		0.3177	0.3278
	0.3183	0.3224		0.3172	0.3332
	0.3144	0.3186		0.313	0.329
PS	0.3190	0.3170	P8	0.3177	0.3278
	0.3225	0.3200		0.3217	0.3317
	0.3221	0.3261		0.3213	0.3373
	0.3183	0.3224		0.3172	0.3332
P1	0.3068	0.3113	P9	0.3048	0.3207
	0.3106	0.315		0.3089	0.3249
	0.3098	0.3199		0.308	0.3298
	0.3058	0.316		0.3038	0.3256
P2	0.3106	0.315	PA	0.3089	0.3249
	0.3144	0.3186		0.313	0.329
	0.3137	0.3238		0.3123	0.3341
	0.3098	0.3199		0.308	0.3298
P3	0.3144	0.3186	PB	0.313	0.329
	0.3183	0.3224		0.3172	0.3332
	0.3177	0.3278		0.3166	0.3384
	0.3137	0.3238		0.3123	0.3341
P4	0.3183	0.3224	PC	0.3172	0.3332
	0.3221	0.3261		0.3213	0.3373
	0.3217	0.3317		0.3209	0.3427
	0.3177	0.3278		0.3166	0.3384

Note: Samsung maintains measurement tolerance of : Cx, Cy = ± 0.005

f) Kitting Chromaticity Region & Coordinates ($I_F = 65 \text{ mA}$, $T_s = 25 \text{ }^\circ\text{C}$)

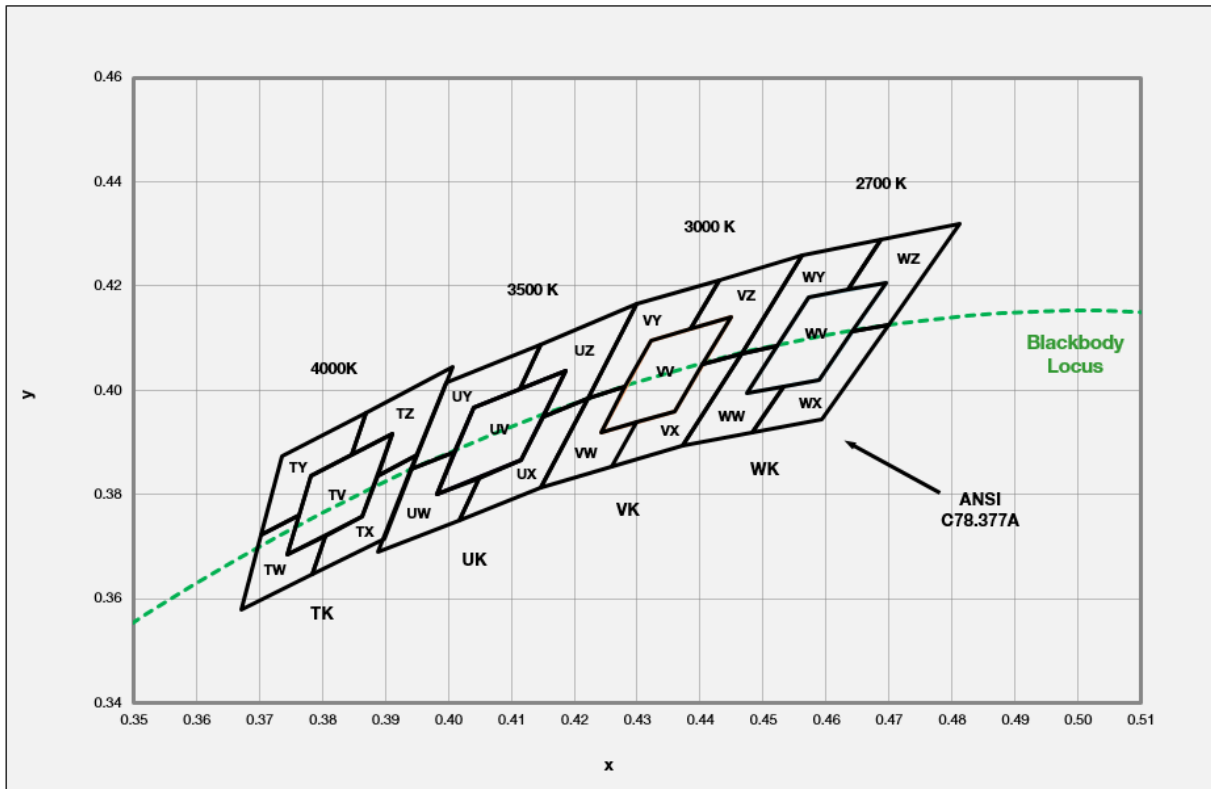
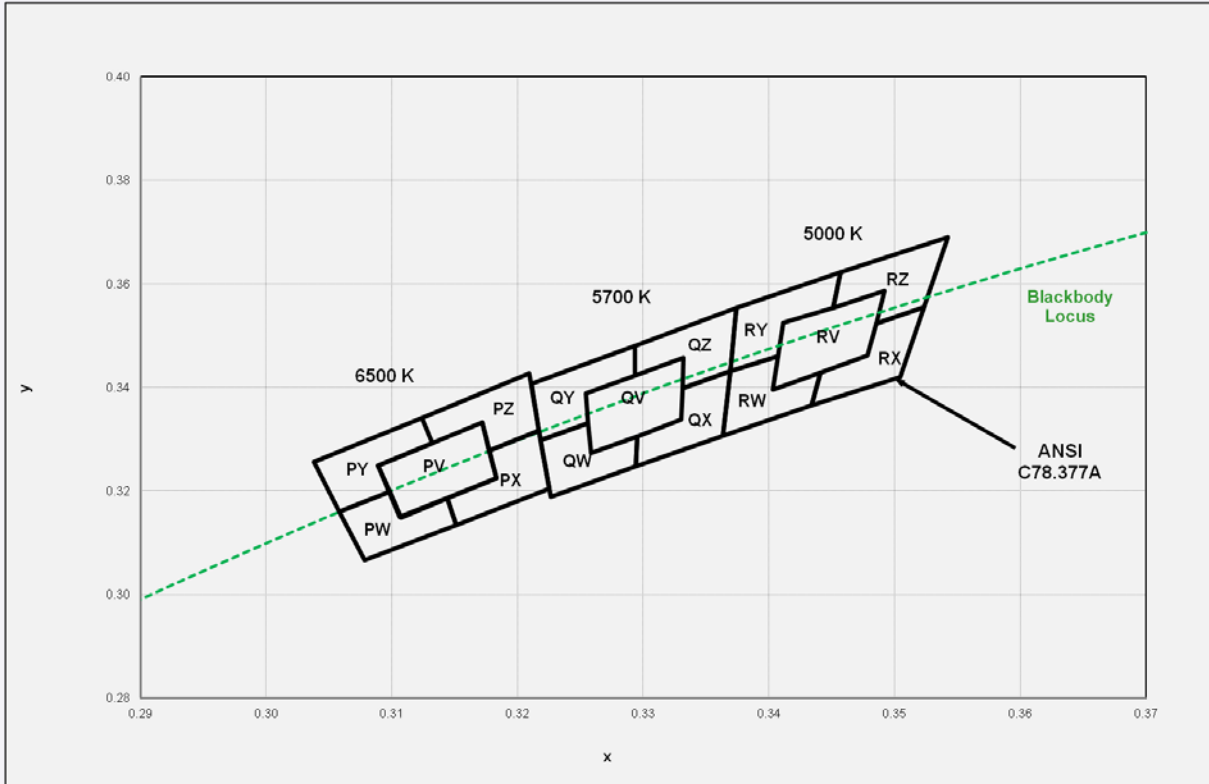

f) Kitting Chromaticity Region & Coordinates ($I_F = 65 \text{ mA}$, $T_s = 25 \text{ }^\circ\text{C}$)

Region	CIE x	CIE y	Region	CIE x	CIE y
W rank (2700 K)					
WW	0.4475	0.3994			
	0.4589	0.4021			
	0.4695	0.4207			
	0.4573	0.4178			
WW	0.4373	0.3893	WY	0.4465	0.4071
	0.4483	0.3919		0.4523	0.4085
	0.4532	0.4008		0.4573	0.4178
	0.4475	0.3994		0.4634	0.4193
	0.4523	0.4085		0.4687	0.4289
	0.4465	0.4071		0.4562	0.4260
WX	0.4483	0.3919	WZ	0.4641	0.4112
	0.4593	0.3944		0.4700	0.4126
	0.4700	0.4126		0.4813	0.4319
	0.4641	0.4112		0.4687	0.4289
	0.4589	0.4021		0.4634	0.4193
	0.4532	0.4008		0.4695	0.4207

Region	CIE x	CIE y	Region	CIE x	CIE y
V rank (3000 K)					
VV	0.4242	0.3919			
	0.4359	0.3960			
	0.4449	0.4141			
	0.4322	0.4096			
VV	0.4147	0.3814	VY	0.4221	0.3984
	0.4259	0.3853		0.4281	0.4006
	0.4300	0.3939		0.4322	0.4096
	0.4242	0.3919		0.4385	0.4119
	0.4281	0.4006		0.4430	0.4212
	0.4221	0.3984		0.4299	0.4165
VX	0.4259	0.3853	VZ	0.4403	0.4049
	0.4373	0.3893		0.4465	0.4071
	0.4465	0.4071		0.4562	0.4260
	0.4403	0.4049		0.4430	0.4212
	0.4359	0.3960		0.4385	0.4119
	0.4300	0.3939		0.4449	0.4141

f) Kitting Chromaticity Region & Coordinates

Region	CIE x	CIE y	Region	CIE x	CIE y
U rank (3500 K)					
UV	0.3981	0.3800			
	0.4116	0.3865			
	0.4186	0.4037			
	0.4040	0.3966			
UW	0.3889	0.3690	UY	0.3941	0.3848
	0.4017	0.3751		0.4010	0.3882
	0.4048	0.3832		0.4040	0.3966
	0.3981	0.3800		0.4113	0.4001
	0.4010	0.3882		0.4146	0.4089
	0.3941	0.3848		0.3996	0.4015
UX	0.4017	0.3751	UZ	0.4150	0.3950
	0.4147	0.3814		0.4221	0.3984
	0.4221	0.3984		0.4299	0.4165
	0.4150	0.3950		0.4146	0.4089
	0.4116	0.3865		0.4113	0.4001
	0.4048	0.3832		0.4186	0.4037

Region	CIE x	CIE y	Region	CIE x	CIE y
T rank (4000 K)					
TV	0.3744	0.3685			
	0.3863	0.3758			
	0.3912	0.3917			
	0.3782	0.3837			
TW	0.3670	0.3578	TY	0.3702	0.3722
	0.3783	0.3646		0.3763	0.3760
	0.3804	0.3721		0.3782	0.3837
	0.3744	0.3685		0.3847	0.3877
	0.3763	0.3760		0.3869	0.3958
	0.3702	0.3722		0.3736	0.3874
TX	0.3783	0.3646	TZ	0.3887	0.3837
	0.3898	0.3716		0.3950	0.3875
	0.3950	0.3875		0.4006	0.4044
	0.3887	0.3837		0.3869	0.3958
	0.3863	0.3758		0.3847	0.3877
	0.3804	0.3721		0.3912	0.3917

f) Kitting Chromaticity Region & Coordinates

Region	CIE x	CIE y	Region	CIE x	CIE y
R rank (5000 K)					
RV	0.3403	0.3398			
	0.3477	0.3458			
	0.3492	0.3587			
	0.3411	0.3522			
RW	0.3364	0.3292	RY	0.3369	0.3431
	0.3434	0.3344		0.3407	0.346
	0.344	0.3427		0.3411	0.3522
	0.3403	0.3398		0.3451	0.3554
	0.3407	0.346		0.3457	0.3621
	0.3369	0.3431		0.3374	0.3553
RX	0.3434	0.3344	RZ	0.3485	0.3522
	0.3504	0.3398		0.3524	0.3554
	0.3524	0.3554		0.3542	0.369
	0.3485	0.3522		0.3457	0.3621
	0.3477	0.3458		0.3451	0.3554
	0.344	0.3427		0.3492	0.3587

Region	CIE x	CIE y	Region	CIE x	CIE y
Q rank (5700 K)					
QV	0.3258	0.3275			
	0.333	0.3338			
	0.3332	0.3458			
	0.3254	0.3388			
QW	0.3227	0.318	QY	0.3218	0.3298
	0.3294	0.3235		0.3256	0.3331
	0.3294	0.3306		0.3254	0.3388
	0.3258	0.3275		0.3293	0.3423
	0.3256	0.3331		0.3293	0.3481
	0.3218	0.3298		0.3211	0.3407
QX	0.3294	0.3235	QZ	0.3293	0.3423
	0.3364	0.3292		0.3332	0.3458
	0.3369	0.3431		0.3331	0.3398
	0.3331	0.3398		0.3369	0.3431
	0.333	0.3338		0.3374	0.3554
	0.3294	0.3306		0.3293	0.3481

f) Kitting Chromaticity Region & Coordinates

Region	CIE x	CIE y	Region	CIE x	CIE y
P rank (6500 K)					
PV	0.3106	0.315			
	0.3183	0.3224			
	0.3172	0.3332			
	0.3089	0.3249			
PW	0.3079	0.306	PY	0.3058	0.316
	0.3152	0.3133		0.3098	0.3199
	0.3144	0.3186		0.3089	0.3249
	0.3106	0.3150		0.313	0.329
	0.3098	0.3199		0.3123	0.3341
	0.3058	0.3160		0.3038	0.3256
PX	0.3152	0.3133	PZ	0.313	0.329
	0.3225	0.32		0.3172	0.3332
	0.3217	0.3317		0.3177	0.3278
	0.3177	0.3278		0.3217	0.3317
	0.3183	0.3224		0.3209	0.3427
	0.3144	0.3186		0.3123	0.3341

Note:

Samsung maintains measurement tolerance of: $C_x, C_y = \pm 0.005$

3. Typical Characteristics Graphs

a) Spectrum Distribution ($I_f = 65 \text{ mA}$, $T_s = 25 \text{ }^\circ\text{C}$)

CCT: 2700 K (90 CRI)

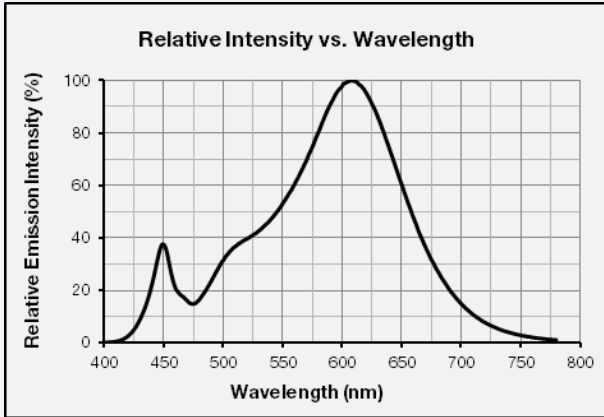

CCT: 3000 K (90 CRI)

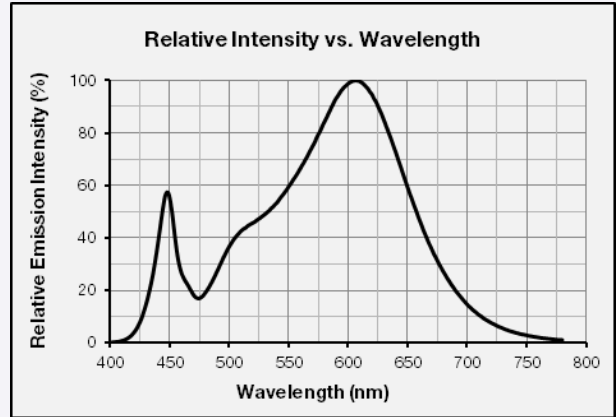

CCT: 3500 K (90 CRI)

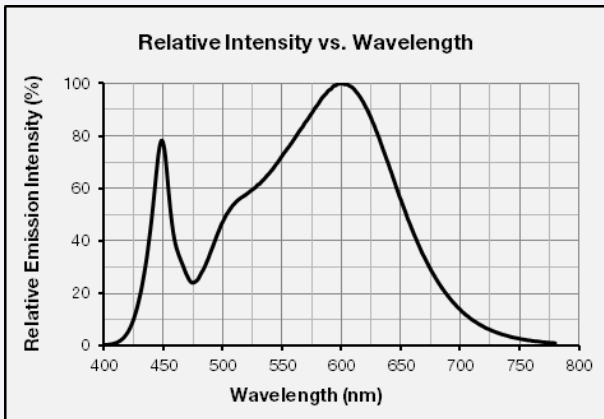

CCT: 4000 K (90 CRI)

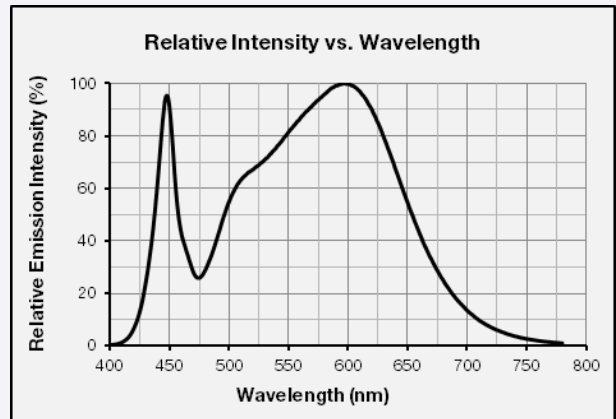

CCT: 5000 K (90 CRI)

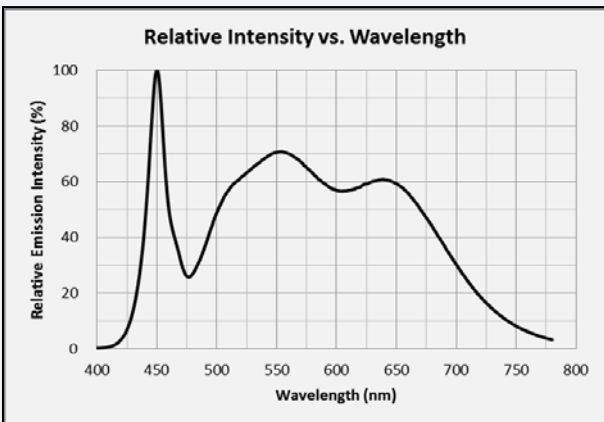

CCT: 5700 K (90 CRI)

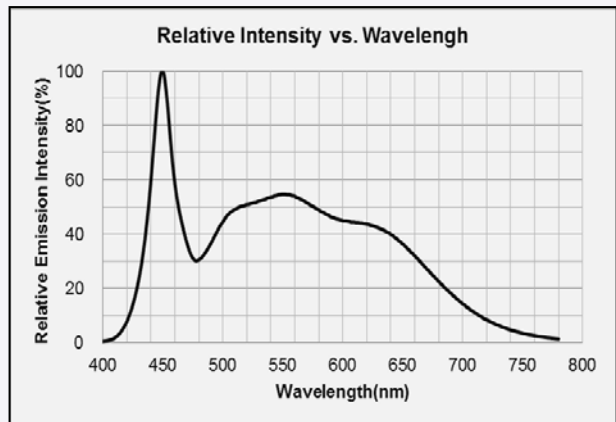

CCT: 6500 K (90 CRI)

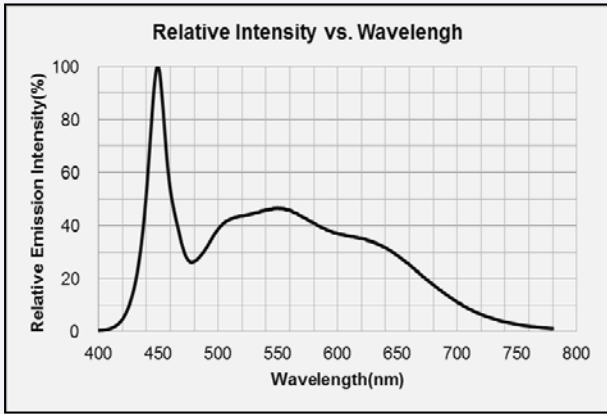

b) Forward Current Characteristics ($T_s = 25\text{ }^\circ\text{C}$)

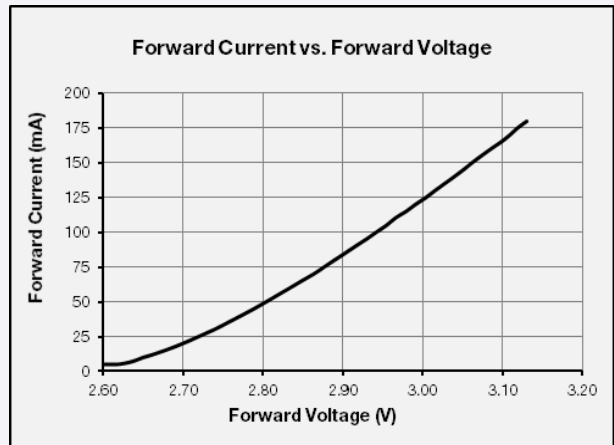
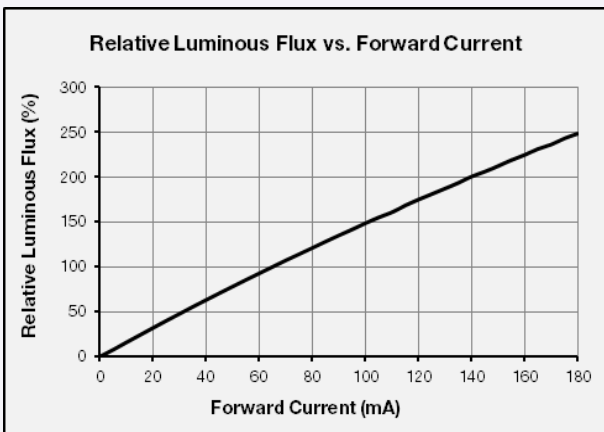

c) Temperature Characteristics ($I_f = 65\text{ mA}$)

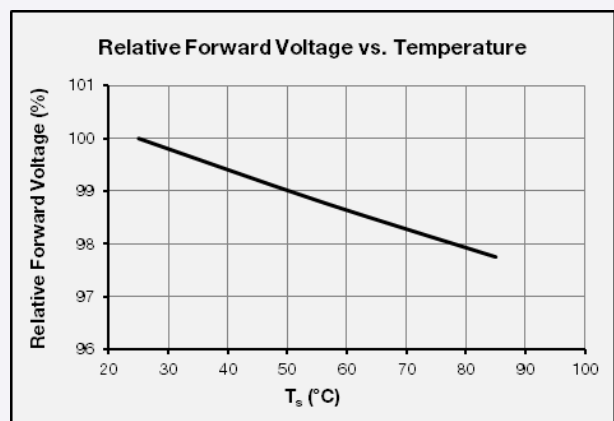
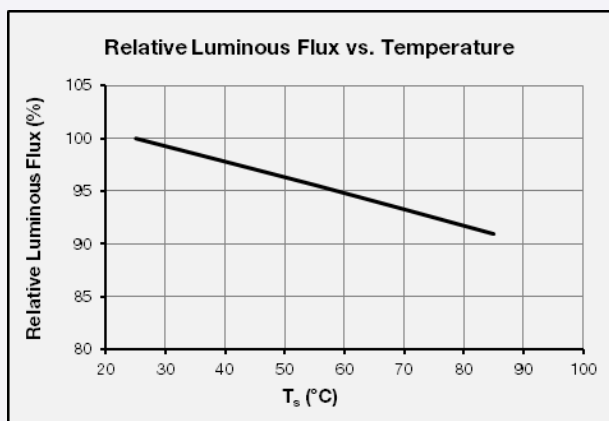

d) Color Shift Characteristics

$T_s = 25\text{ }^\circ\text{C}$

$I_F = 65\text{ mA}$

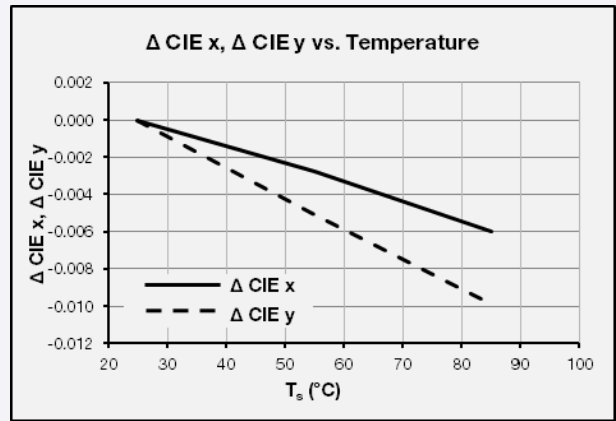
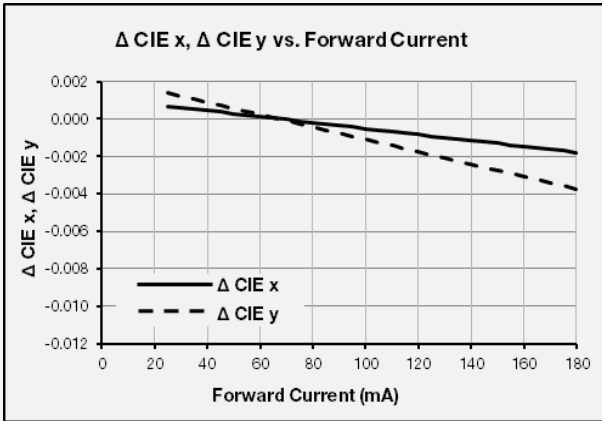

e) Derating Curve

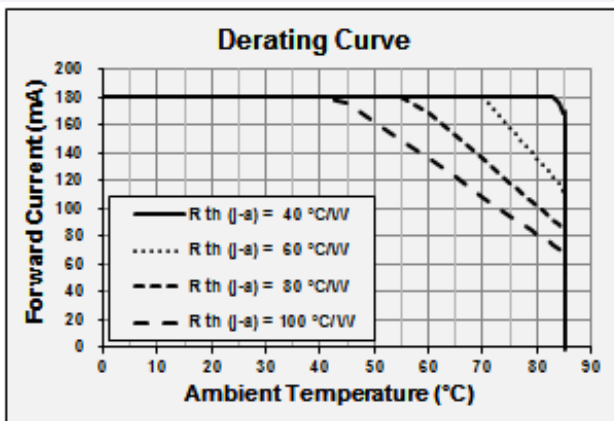

f) Beam Angle Characteristics ($I_F = 65\text{ mA}$, $T_s = 25\text{ }^\circ\text{C}$)

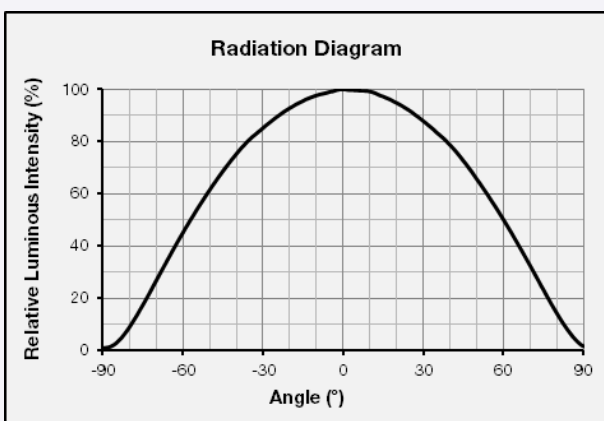

4. Outline Drawing & Dimension

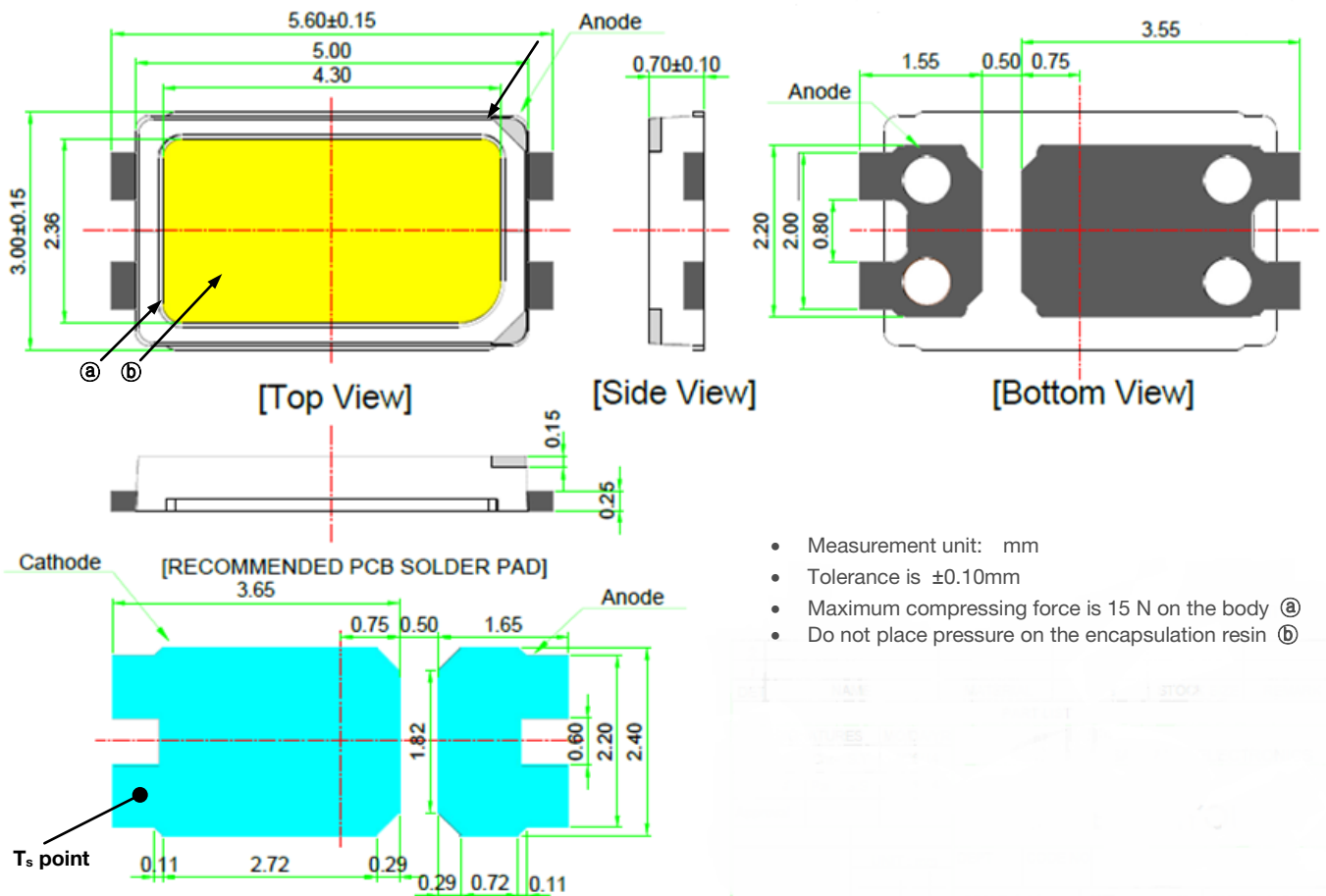

Notes:

- 1) This LED has built-in ESD protection device(s) connected in parallel to LED chip(s).
- 2) T_s point and measurement method:
 - ① Measure one point at the cathode pad, if necessary remove PSR of PCB to reach T_s point.
 - ② All pads must be soldered to the PCB to dissipate heat properly, otherwise the LED can be damaged.

Precautions:

- 1) Pressure on the LEDs will influence to the reliability of the LEDs. Precautions should be taken to avoid strong pressure on the LEDs. Do not put stress on the LEDs during heating.
- 2) Re-soldering should not be done after the LEDs have been soldered. If re-soldering is unavoidable, LED's characteristics should be carefully checked before and after such repair.
- 3) Do not stack assembled PCBs together. Since materials of LEDs is soft, abrasion between two PCB assembled with LED might cause catastrophic failure of the LEDs.

5. Reliability Test Items & Conditions

a) Test Items

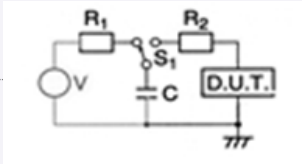
Test Item	Test Condition	Test Hour / Cycle	Sample No.	
High Temperature Life Test	85 °C, DC 180 mA	1000 h	22	
High Temperature Humidity Life Test	60 °C, 90 % RH, DC 180 mA	1000 h	22	
Powered Temperature Cycle Test	-40 °C / 10 min ↔ 85 °C / 10 min, sweep 20 min cycle on/off: each 5 min, DC 180 mA	100 cycles	22	
Thermal Cycle	-45 °C / 15 min ↔ 125 °C / 15 min → Hot plate 180 °C	500 cycles	100	
High Temperature Storage	120 °C	1000 h	11	
Low Temperature Storage	-40 °C	1000 h	11	
ESD (HBM)		R ₁ : 10 MΩ R ₂ : 1.5 kΩ C: 100 pF V: ±5 kV	5 times	30
		R ₁ : 10 MΩ R ₂ : 0 C: 200 pF V: ±0.5 kV	5 times	30
ESD (MM)				
Vibration Test	20~2000~20 Hz, 200 m/s ² , sweep 4 min X, Y, Z 3 direction, each 1 cycle	4 cycles	11	
Mechanical Shock Test	1500 g, 0.5 ms 3 shocks each X-Y-Z axis	5 cycles	11	

b) Criteria for Judging the Damage

Item	Symbol	Test Condition (T _s = 25 °C)	Limit	
			Min	Max
Forward Voltage	V _F	I _F = 65 mA	Init. Value * 0.9	Init. Value * 1.1
Luminous Flux	Φ _v	I _F = 65 mA	Init. Value * 0.7	Init. Value * 1.1

6. Soldering Conditions

a) Reflow Conditions (Pb free)

Reflow frequency: 2 times max.

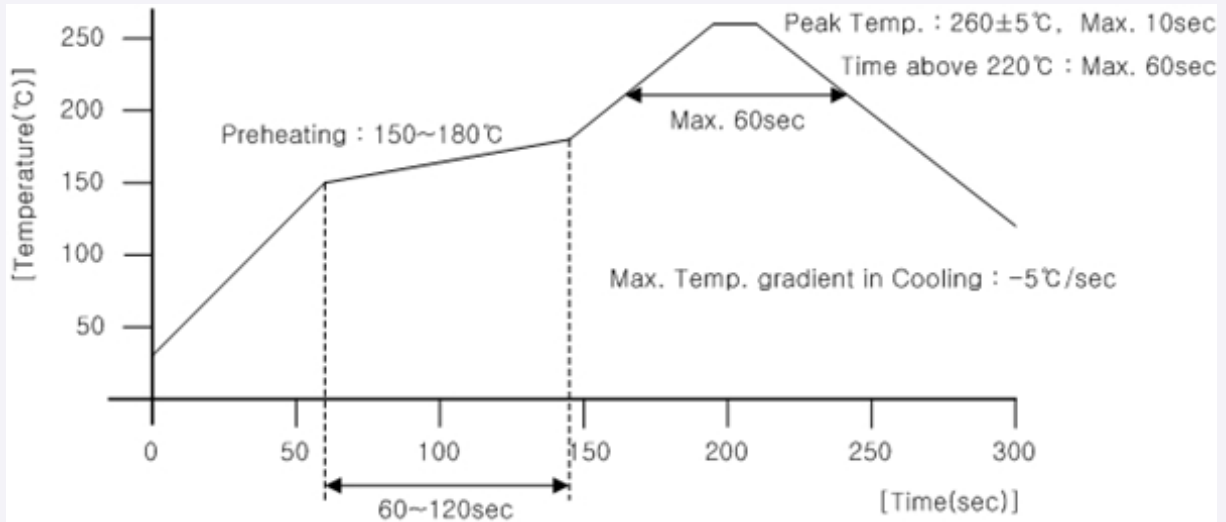

b) Manual Soldering Conditions

Not more than 5 seconds @ max. 300 °C, under soldering iron.

7. Tape & Reel

a) Taping Dimension

(unit: mm)

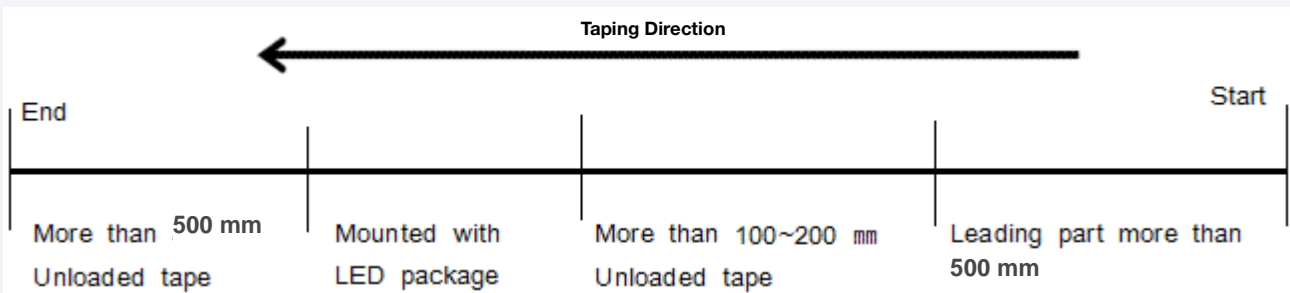
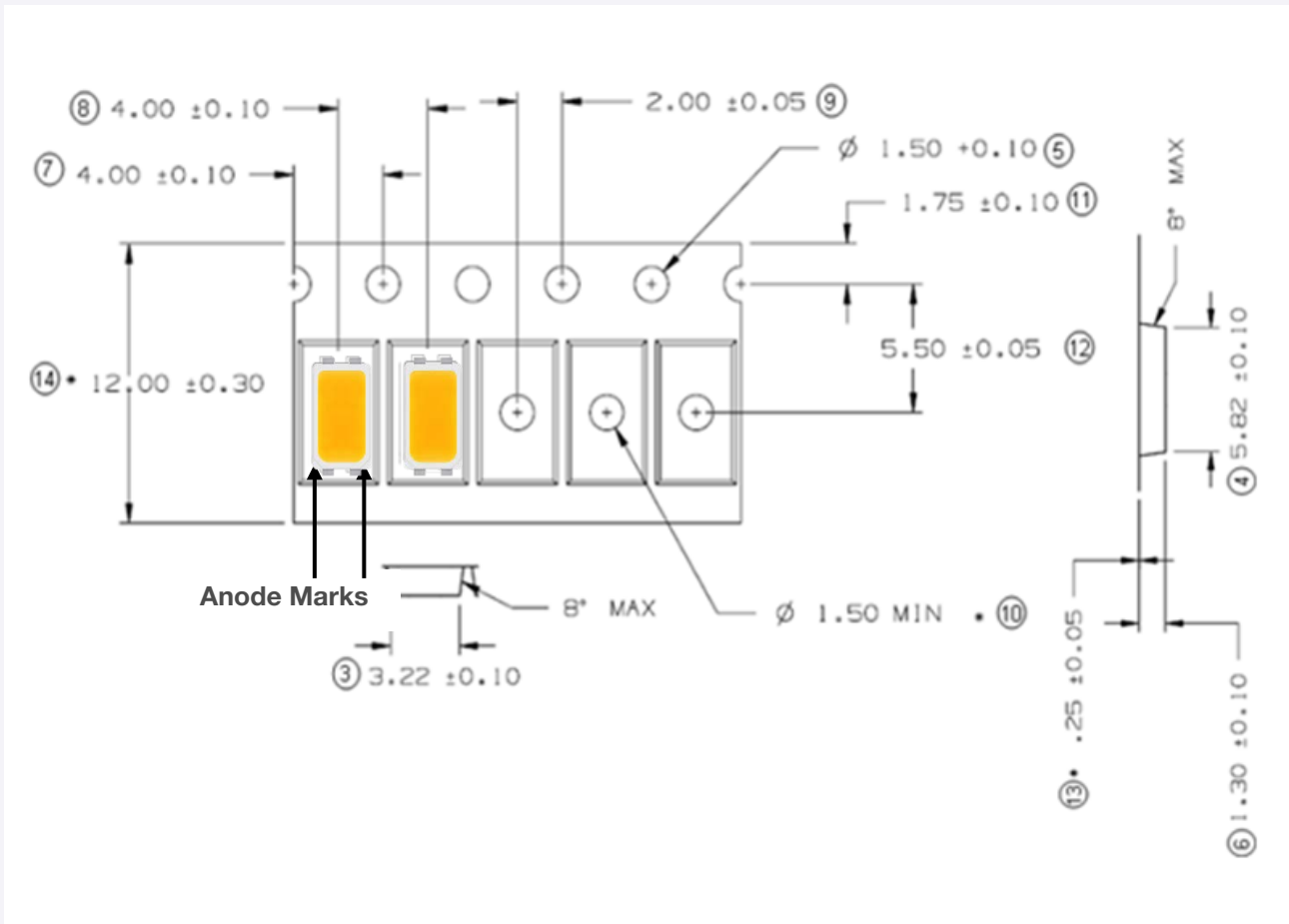

b) Reel Dimension (Max 2,500 pcs)

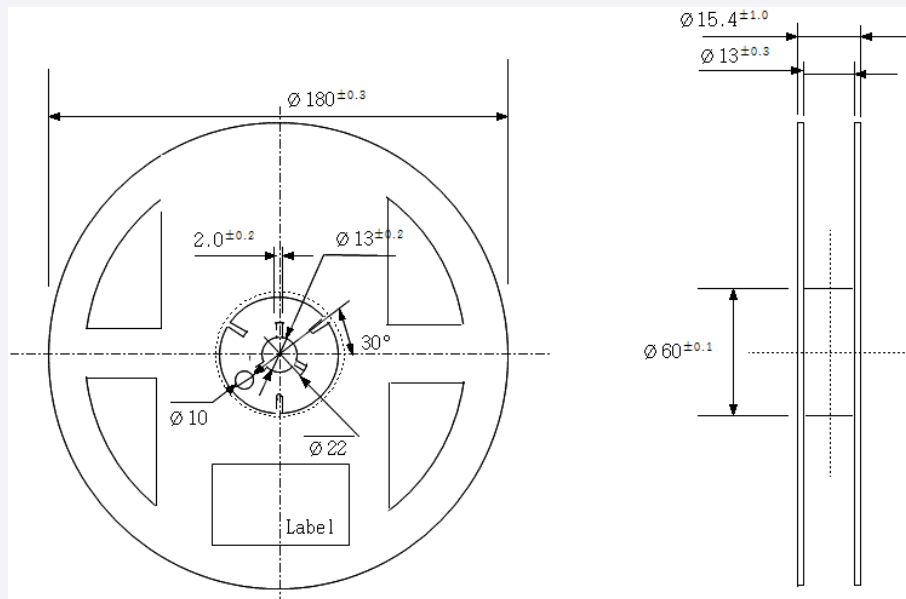

(unit: mm)

Notes:

- 1) Quantity: The quantity/reel is 2,500
- 2) Cumulative Tolerance: Cumulative tolerance / 10 pitches is ± 0.2 mm
- 3) Adhesion Strength of Cover Tape: Adhesion strength is 0.1-0.7 N when the cover tape is turned off from the carrier tape at 10° angle to the carrier tape
- 4) Packaging: P/N, Manufacturing data code no. and quantity are indicated on the aluminum packing bag

8. Label Structure

a) Label Structure

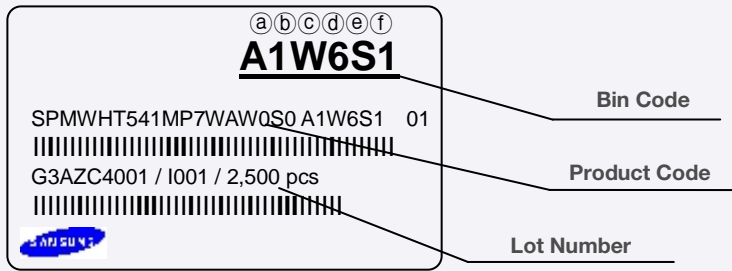

Note: Denoted bin code and product code above is only an example (see description on page 5)

Bin Code:

- ⒶⒷ: Forward Voltage bin (refer to page 10)
- ⒸⒹ: Chromaticity bin (refer to page 9)
- ⒺⒻ: Luminous Flux bin (refer to page 6)

b) Lot Number

The lot number is composed of the following characters:



① ③④⑤⑥⑦⑧⑨ / 1ⒶⒷⒸ / 2,500 pcs

- ①, ② : Production site (GL : Tianjin, China, G3: Shenzhen, China, G4 : Guangzhou, China)
- ③ : Product state (A: Normal, B: Bulk, C: First Production, R: Reproduction, S: Sample)
- ④ : Year (Z: 2015, A: 2016, B: 2017, C:2018...)
- ⑤ : Month (1~9, A, B, C)
- ⑥⑦⑧⑨ : Day (1~9, A, B~V)
- ⒶⒷⒸ : Product serial number (001 ~ 999)

9. Packing Structure

a) Packing Process (The quantity of PKG on the Reel to be Max 2,500pcs)

Reel

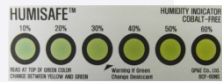
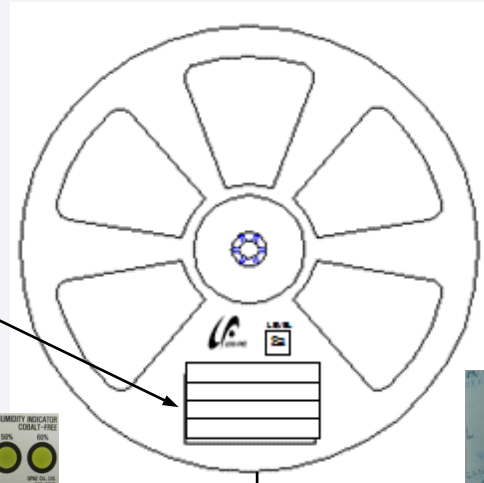

Aluminum Vinyl Packing Bag



Outer Box

Material: Paper (SW3B(B))

Type	Size (mm)			Note
	L	W	H	
7 inch L	245 ± 5	220 ± 5	182 ± 5	Up to 10 reels

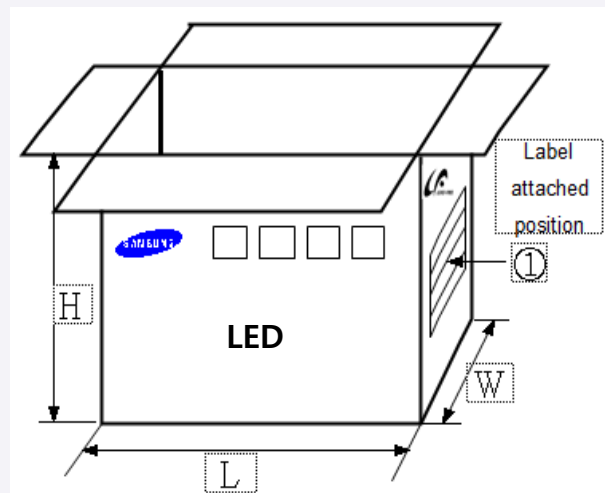
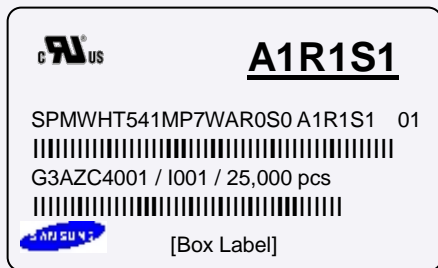

b) Packing Process for kitting (The quantity of PKG on the Reel to be Max 2,500pcs)

Reel

Kitting 'A'

AMS **A1◇WS1**
 SPMWHT541MP7WA◇KS1 A1◇1S1 01
 G3AW94001 / I001 / 2,500 pcs

Kitting 'B'

AMS **A1◇ZS1**
 SPMWHT541MP7WA◇KS1 A1◇GS1 01
 G3AW94001 / I001 / 2,500 pcs

Kitting 'A'

Kitting 'B'

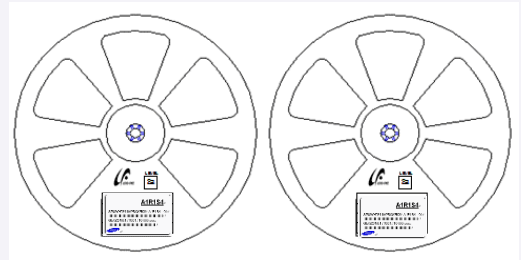

Aluminum Vinyl Packing Bag

Kitting 'A'

AMS **A1◇WS1**
 SPMWHT541MP7WA◇KS1 A1◇1S1 01
 G3AW94001 / I001 / 2,500 pcs

Kitting 'B'

AMS **A1◇ZS1**
 SPMWHT541MP7WA◇KS1 A1◇GS1 01
 G3AW94001 / I001 / 2,500 pcs

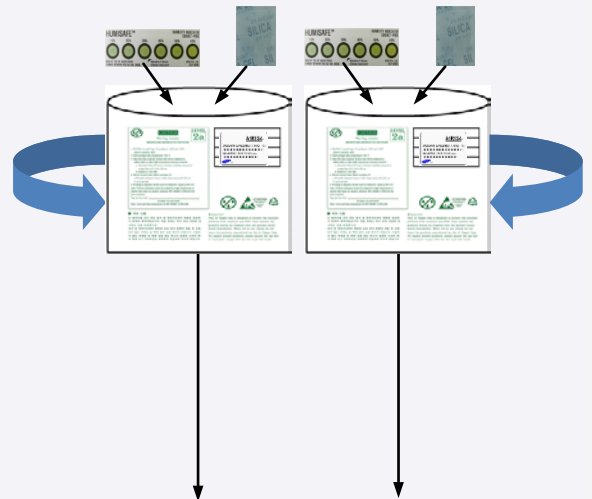

Note: "◇" can be Nominal CCT code.

Outer Box

Material: Paper (SW3B(B))

Type	Size (mm)			Note
	L	W	H	
7 inch L	245 ± 5	220 ± 5	182 ± 5	Up to 10 reels

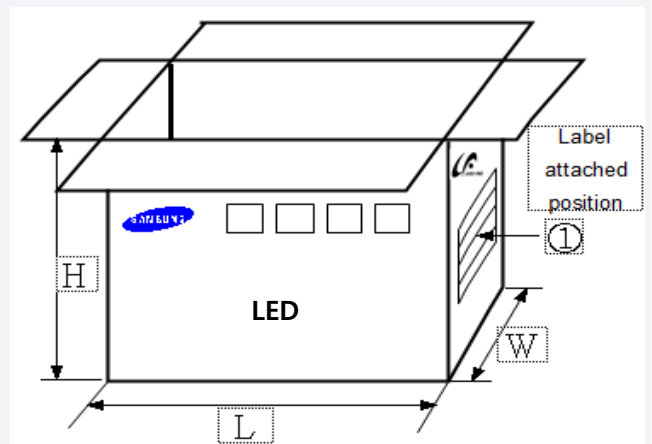

c) Aluminum Vinyl Packing Bag



CAUTION

This bag contains
MOISTURE SENSITIVE DEVICES

LEVEL

2a

A1W6S1

SPMWHT541MP7WAW0S0 A1W6S1 01
 |||
 G3AZC4001 / I001 / 2,500 pcs
 |||

1. Shelf life in sealed bag: 12 months at <40°C and <90% relative humidity (RH)
2. Peak package body temperature: 240 °C
3. After this bag is opened, devices that will be subjected to reflow solder or other high temperature processes must be:
 - a. Mounted within 672 hours at factory conditions of equal to or less than 30°C / 60% RH, or
 - b. Stored at <10% RH
4. Devices require bake, before mounting, if:
 - a. Humidity Indicator Card is >60% when read at 23±5°C, or
 - b. 2a is not met.
5. If baking is required, devices must be baked for 10 ~ 24 hours at 60±5°C

Note: If device containers cannot be subjected to high temperature or shorter bake times are desired, reference IPC/JEDEC J-STD-033 for bake procedure.

Bag seal due date: _____
(If blank, see code label)

Note: Level and body temperature by IPC/JEDEC J-STD-020









■ 주의 사항

이 알루미늄 지퍼 백은 습기 및 정전기로부터 제품을 보호하기 위하여 제작되었습니다. 개봉 후에는 즉시 솔더 작업을 실시하는 것을 권장합니다.

습기 및 정전기로부터 제품을 보호 하기 위해서 개봉 후 사용하지 않는 자재는 본 팩에 넣어 보관 하시기 바랍니다. 사용하지 않는 자재를 본 팩에 넣을 때는 반드시 동봉된 드라이 팩과 함께 넣고 지퍼부분을 완전하게 밀봉하여 주시기 바랍니다.

■ Important

This Al Zipper bag is designed to protect the enclosed products from moisture and ESD. Once opened, the products should be soldered onto the printed circuit board immediately. When not in use, please do not leave the products unprotected by the Al Zipper Bag. To repack unused products., please ensure the zip-lock is completely sealed with the dry pack left inside.

d) Silica Gel & Humidity Indicator Card inside Aluminum Vinyl Bag



HUMISAFE™

10% 20% 30% 40% 50% 60%



READ AT TOP OF GREEN COLOR
CHANGE BETWEEN YELLOW AND GREEN

**HUMIDITY INDICATOR
COBALT-FREE**

Warning If Green
Change Desiccant

GP&E Co., Ltd.
6CF-60NS



10. Precautions in Handling & Use

- 1) For over-current protection, users are recommended to apply resistors connected in series with the LEDs to mitigate sudden change of the forward current caused by shift of forward voltage.
- 2) This device should not be used in any type of fluid such as water, oil, organic solvent, etc. When cleaning is required, IPA is recommended as the cleaning agent. Some solvent-based cleaning agent may damage the silicone resins used in the device.
- 3) When the device is in operation, the forward current should be carefully determined considering the maximum ambient temperature and corresponding junction temperature.
- 4) LEDs must be stored in a clean environment. If the LEDs are to be stored for three months or more after being shipped from Samsung, they should be packed with a nitrogen-filled container (shelf life of sealed bags is 12 months at temperature 0~40 °C, 0~90 % RH).
- 5) After storage bag is opened, device subjected to soldering, solder reflow, or other high temperature processes must be:
 - a. Mounted within 672 hours (28 days) at an assembly line with a condition of no more than 30 °C / 60 % RH, or
 - b. Stored at <10 % RH
- 6) Repack unused devices with anti-moisture packing, fold to close any opening and then store in a dry place.
- 7) Devices require baking before mounting, if humidity card reading is >60 % at 23 ± 5 °C.
- 8) Devices must be baked for 10~24 hours at 60 ± 5 °C, if baking is required.
- 9) The LEDs are sensitive to the static electricity and surge current. It is recommended to use a wrist band or anti-electrostatic glove when handling the LEDs. If voltage exceeding the absolute maximum rating is applied to LEDs, it may cause damage or even destruction to LED devices. Damaged LEDs may show some unusual characteristics such as increase in leakage current, lowered turn-on voltage, or abnormal lighting of LEDs at low current.
- 10) VOCs (Volatile Organic Compounds) can be generated from adhesives, flux, hardener or organic additives used in luminaires (fixtures). Transparent LED silicone encapsulant is permeable to those chemicals and they may lead to a discoloration of encapsulant when they exposed to heat or light. This phenomenon can cause a significant loss of light emitted (output) from the luminaires. In order to prevent these problems, we recommend users to know the physical properties of materials used in luminaires and they must be carefully selected.
- 11) Risk of sulfurization (or tarnishing)
 The LED from Samsung uses a silver-plated lead frame and its surface color may change to black (or dark colored) when it is exposed to sulfur (S), chlorine (Cl) or other halogen compound. Sulfurization of lead frame may cause intensity degradation, change of chromaticity coordinates and, in extreme cases, open circuit. It requires caution. Due to possible sulfurization of lead frame, LED should not be used and stored together with oxidizing substances made of materials such as rubber, plain paper, lead solder cream, etc.

Legal and additional information.

[About Samsung Electronics Co., Ltd.](#)

Samsung Electronics Co., Ltd. is a global leader in technology, opening new possibilities for people everywhere. Through relentless innovation and discovery, we are transforming the worlds of TVs, smartphones, tablets, PCs, cameras, home appliances, printers, LTE systems, medical devices, semiconductors and LED solutions. We employ 286,000 people across 80 countries with annual sales of US\$216.7 billion. To discover more, please visit www.samsungled.com.

Copyright © 2015 Samsung Electronics Co., Ltd. All rights reserved.
Samsung is a registered trademark of Samsung Electronics Co., Ltd.
Specifications and designs are subject to change without notice. Non-metric weights and measurements are approximate. All data were deemed correct at time of creation. Samsung is not liable for errors or omissions. All brand, product, service names and logos are trademarks and/or registered trademarks of their respective owners and are hereby recognized and acknowledged.

Samsung Electronics Co., Ltd.
95, Samsung 2-ro
Giheung-gu
Yongin-si, Gyeonggi-do, 446-711
KOREA

www.samsungled.com

