

Series PVR13

Microelectronic Power IC
 BOSFET® Photovoltaic Relay
 Dual-Pole, 400mA, 0-100V AC/DC

General Description

The PVR13 Photovoltaic Relay is a dual-pole, normally open solid state replacement for electro-mechanical relays. It utilizes as an output switch a unique bidirectional (AC or DC) MOSFET power IC termed a BOSFET. The BOSFET is controlled by a photo-voltaic generator of novel construction, which is energized by radiation from a dielectrically isolated light emitting diode (LED).

The PVR overcomes the limitations of reed relays by offering the solid state advantages of long life, high operating speed, low pick-up power, bounce-free operation, low thermal voltages and miniaturization. These advantages allow product improvement and design innovations in many applications such as process control, multiplexing, telecommunications, automatic test equipment and data acquisition.

The PVR can switch analog signals from thermocouple level to 100 volts peak AC or DC polarity. Signal frequencies into the RF range are easily controlled and switching rates up to 5kHz are achievable. The extremely small thermally generated offset voltages allow increased measurement accuracies. Unique silicon technology developed by International Rectifier forms the heart of the PVR. The monolithic BOSFET contains a bidirectional N-channel power MOSFET output structure. In addition, this power IC chip has input circuitry for fast turn-off and gate protection functions. This section of the BOSFET chip utilizes both bipolar and MOS technology to form NPN transistors, P-channel MOSFETs, resistors, diodes and capacitors.

The photovoltaic generator similarly utilizes a unique International Rectifier alloyed multijunction structure. The excellent current conversion efficiency of this technique results in the very fast response of the PVR microelectronic power IC relay.

This advanced semiconductor technology has created a radically new control device. Designers can now develop switching systems to new standards of electrical performance and mechanical compactness.

Features

- BOSFET Power IC ■
- 10¹⁰ Operations ■
- 300µsec Operating Time ■
- 0.2µVolt Thermal Offset ■
- 5 milliwatts Pick-Up Power ■
- 1000V/µsec dv/dt ■
- Bounce-Free ■
- 16-pin DIP Package ■
- 40°C to 85°C ■

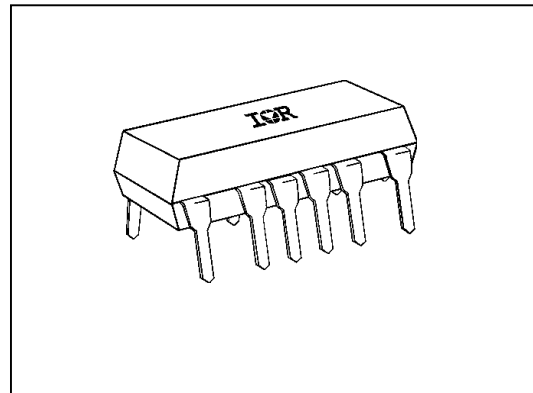

Part Identification

Part Number	Operating Voltage (AC/DC)	Off-State Resistance
PVR1300		10 ⁸ Ohms
PVR1301	0 – 100V	10 ¹⁰ Ohms

(BOSFET is a trademark of International Rectifier)

Electrical Specifications ($-40^{\circ}\text{C} \leq T_A \leq +85^{\circ}\text{C}$ unless otherwise specified)

INPUT CHARACTERISTICS	A Connection	C Connection	Units
Minimum Control Current (see figure 1)			DC
For 100mA Continuous Load Current	1	1	mA@25°C
For 400mA Continuous Load Current	10	5	mA@25°C
For 100mA Continuous Load Current	10	7	mA@85°C
Minimum Turn-Off Current	10		μA(DC)
Minimum Turn-Off Voltage	0.6		V(DC)
Control Current Range (Caution: current limit input LED. See figure 6)	2.0 to 25		mA(DC)
Maximum Reverse Voltage	7.0		V(DC)

OUTPUT CHARACTERISTICS	A Connection	C Connection	Units
Operating Voltage Range	±100	100	V _(peak)
Maximum Load Current 40°C (see figure 1)	400	700	mA(DC)
Response Time @25°C (see figure 7)			
Maximum T _(on) @ 12mA Control, 100 mA Load, 100 V _{DC}	300		μs
Maximum T _(off) @ 12mA Control, 100 mA Load, 100 V _{DC}	50		μs
Max. On-state Resistance 25°C (Pulsed) (figure 2) 100 mA Load, 12mA Control	5.0	1.5	Ω
Minimum Off-state Resistance 25°C @ 80 V _{DC}			
PVR1300	10 ⁸		Ω
PVR1301	10 ¹⁰		Ω
Maximum Thermal Offset Voltage @ 5.0mA Control	0.2		μvolts
Minimum Off-State dv/dt	1000		V/μs
Output Capacitance (see figure 10)	20	40	pF @ 20VDC

GENERAL CHARACTERISTICS (PVR1300 and PVR1301)		Units
Dielectric Strength: Input-Output	1500	V _{RMS}
Insulation Resistance: Input-Output @ 500V _{DC}	10 ¹² @ 25°C - 50% RH	Ω
Maximum Capacitance: Input-Output	1.0	pF
Lead Temperature (1.6mm below seating plane for 10 seconds) 260	°C	
Ambient Temperature Range:		
Operating	-40 to +85	°C
Storage	-40 to +100	

Replaced by PVR13N

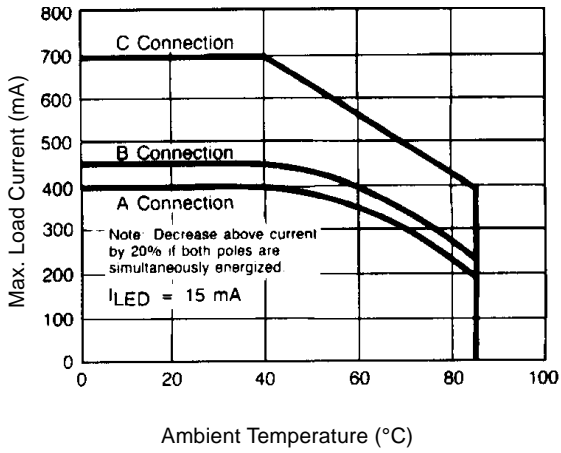

Figure 1. Current Derating Curves

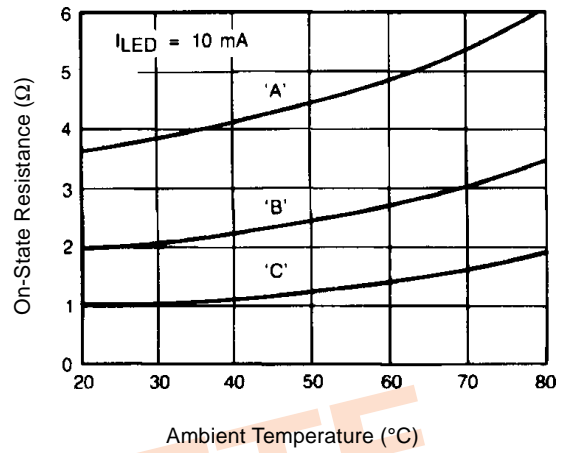

Figure 2. Typical On-Resistance

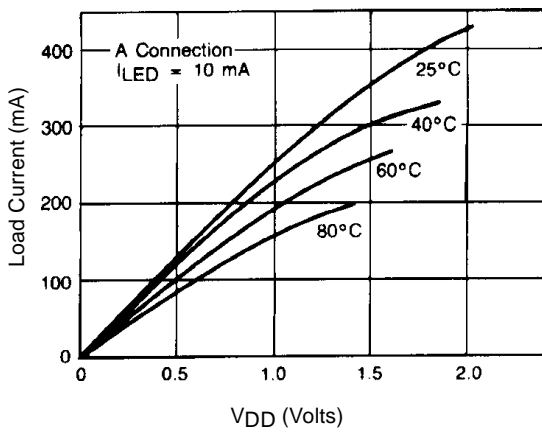

Figure 3. Typical On Characteristics (A Connection)

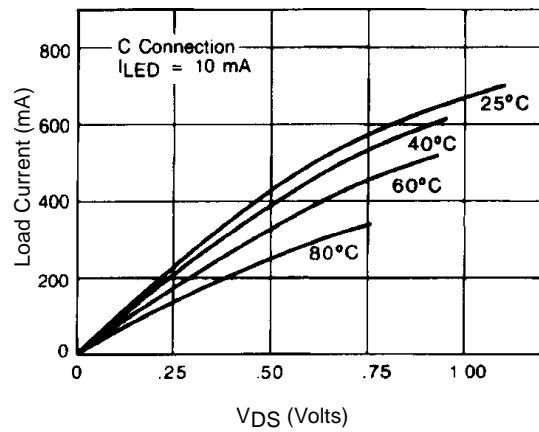

Figure 4. Typical On-Characteristics (C Connection)

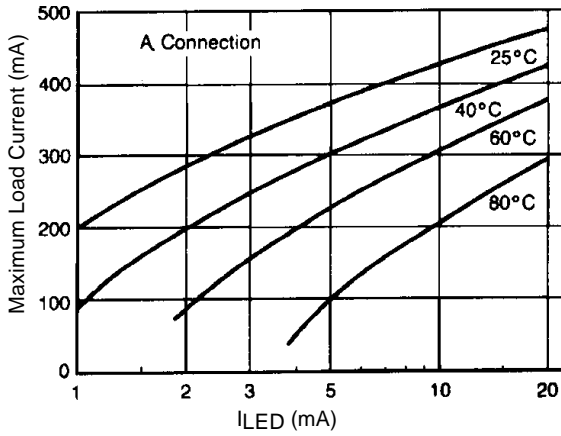

Figure 5. Typical Control Current Requirement (A Connection)

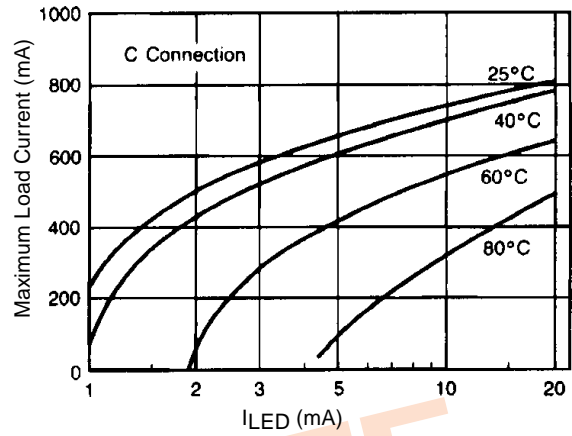

Figure 6. Typical Control Current Requirement (C Connection)

OBSOLETE

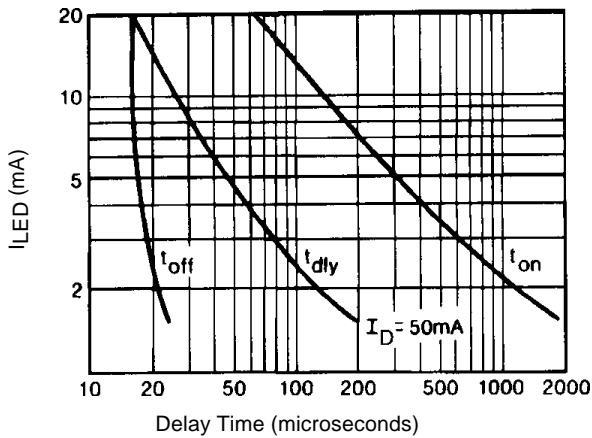

Figure 7. Typical Delay Times

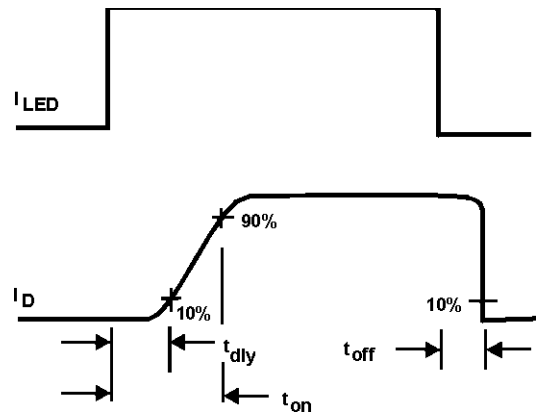

Figure 8. Delay Time Definitions

Replaced by PVR13N

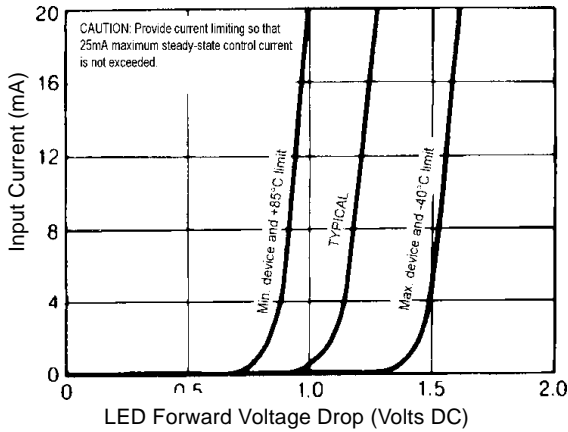

Figure 9. Input Characteristics (Current Controlled)

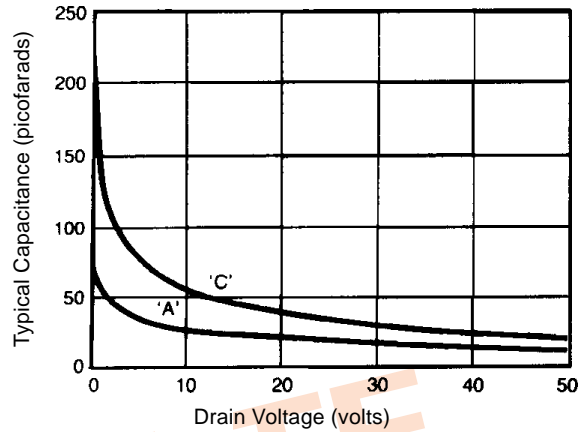
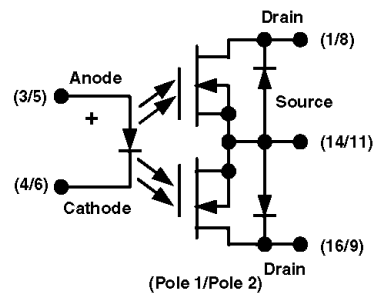
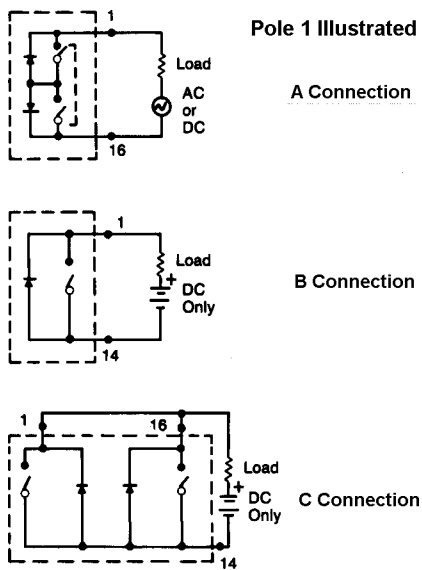

Figure 10. Typical Output Capacitance

OBSOLETE

Wiring Diagram

Schematic Diagram



Case Outline

(Dimensions in inches (millimeters))

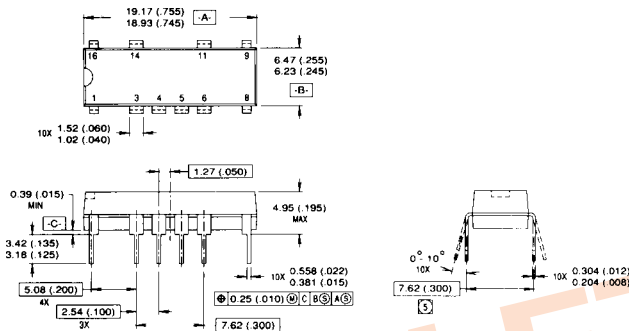

OBSOLETE

Mechanical Specifications:

- Package: 16-pin DIP
- Tolerances: .015 (.38) unless otherwise specified
- Case Material: molded epoxy