

# ATF-58143

## Low Noise Enhancement Mode Pseudomorphic HEMT in a Surface Mount Plastic Package



### Data Sheet

#### Description

Avago Technologies' ATF-58143 is a high dynamic range, low noise E-PHEMT housed in a 4-lead SC-70 (SOT-343) surface mount plastic package.

The combination of high gain, high linearity and low noise makes the ATF-58143 ideal as low noise amplifier for cellular/PCS/WCDMA base stations, wireless local loop, and other applications that require low noise and high linearity performance in the 450 MHz to 6 GHz frequency range.

#### Surface Mount Package SOT-343

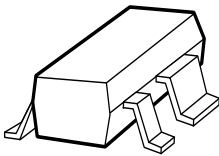

#### Pin Connections and Package Marking

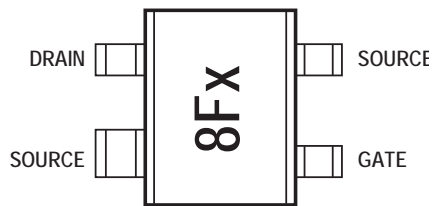

Note:  
Top View. Package marking provides orientation and identification

"8F" = Device Code  
"x" = Date code character  
identifies month of manufacture.

#### Features

- Low noise and high linearity performance
- Enhancement Mode Technology<sup>(1)</sup>
- Excellent uniformity in product specifications
- Low cost surface mount small plastic package SOT-343 (4 lead SC-70) in Tape-and-Reel packaging option available
- Lead-free option available

#### Specifications

2 GHz; 3V, 30 mA (Typ.)

- 30.5 dBm output 3<sup>rd</sup> order intercept
- 19 dBm output power at 1 dB
- 0.5 dB noise figure
- 16.5 dB associated gain

#### Applications

- Q1 LNA for cellular/PCS/WCDMA base stations
- Q1, Q2 LNA and Pre-driver amplifier for 3–4 GHz WLL
- Other low noise and high linearity applications at 450 MHz to 6 GHz

Note:

1. Enhancement mode technology requires positive Vgs, thereby eliminating the need for the negative gate voltage associated with conventional depletion mode devices.



**Attention: Observe precautions for handling electrostatic sensitive devices.**

ESD Machine Model (Class A)  
ESD Human Body Model (Class 1A)  
Refer to Avago Technologies Application Note A004R:  
Electrostatic Discharge Damage and Control.

# ATF-58143 Absolute Maximum Ratings<sup>[1]</sup>

| Symbol        | Parameter                            | Units | AbsoluteMaximum  |
|---------------|--------------------------------------|-------|------------------|
| $V_{DS}$      | Drain-SourceVoltage <sup>[2]</sup>   | V     | 5                |
| $V_{GS}$      | Gate-SourceVoltage <sup>[2]</sup>    | V     | -5to1            |
| $V_{GD}$      | GateDrainVoltage <sup>[2]</sup>      | V     | -5to1            |
| $I_{DS}$      | DrainCurrent <sup>[2]</sup>          | mA    | 100              |
| $P_{diss}$    | TotalPowerDissipation <sup>[3]</sup> | mW    | 500              |
| $P_{inmax}$   | RF InputPower<br>(Vds=3V, Ids=30mA)  | dBm   | +20              |
|               | (Vds=0V, Ids=0mA)                    | dBm   | +20              |
|               | (Vds=4V, Ids=30mA)                   | dBm   | +20              |
| $I_{GS}$      | GateSourceCurrent                    | mA    | 2 <sup>[5]</sup> |
| $T_{CH}$      | ChannelTemperature                   | °C    | 150              |
| $T_{STG}$     | StorageTemperature                   | °C    | -65to150         |
| $\theta_{jc}$ | ThermalResistance <sup>[4]</sup>     | °C/W  | 162              |

**Notes:**

1. Operation of this device above any one of these parameters may cause permanent damage.
2. Assumes DC quiescent conditions.
3. Source lead temperature is 25°C. Derate 6.2 mW/°C for  $T_L > 33^\circ\text{C}$ .
4. Thermal resistance measured using 150°C Liquid Crystal Measurement method.
5. The device can handle +13 dBm RF Input Power provided  $I_{GS}$  is limited to 2 mA.  $I_{GS}$  at  $P_{1dB}$  drive level is bias circuit dependent. See applications section for additional information.

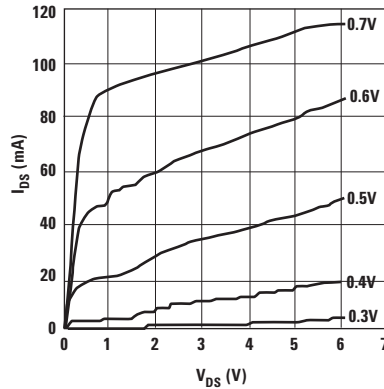

Figure 1. Typical I-V Curves ( $V_{GS}=0.1V$  per step)

## Product Consistency Distribution Charts<sup>[6,7]</sup>

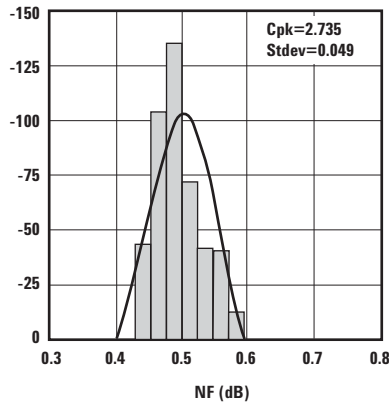

Figure 2. NF @ 3V, 30 mA.  
USL = 0.9, Nominal = 0.5

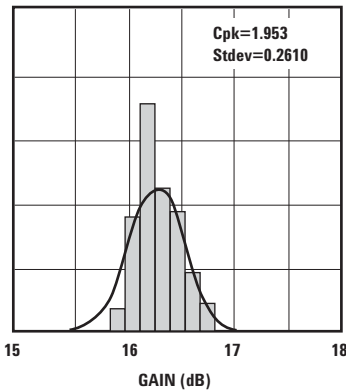

Figure 3. Gain @ 3V, 30 mA.  
USL = 18.5, LSL = 15, Nominal = 16.5

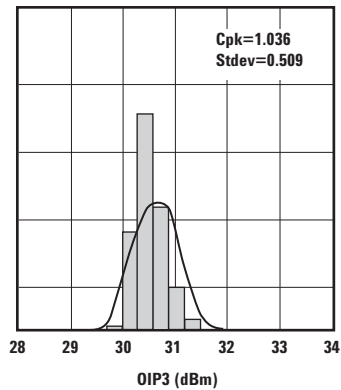

Figure 4. OIP3 @ 3V, 30 mA.  
LSL = 29, Nominal = 30.5

**Notes:**

6. Distribution data sample size is 500 samples taken from 3 different wafers. Future wafers allocated to this product may have nominal values anywhere between the upper and lower limits.
7. Measurements made on production test board. This circuit represents a trade-off between an optimal noise match and a realizable match based on production test equipment. Circuit losses have been de-embedded from actual measurements.

## ATF-58143 Electrical Specifications

$T_A = 25^\circ\text{C}$ , RF parameters measured in a test circuit for a typical device

| Symbol | Parameter and Test Condition                                | Units  | Min.                  | Typ. <sup>[2]</sup> | Max. |      |
|--------|---|--|-----------------------|---------------------|------|------|
| Vgs    | Operational Gate Voltage                                    | Vds = 3V, Ids = 30 mA  | V                     | 0.4                 | 0.75 |      |
| Vth    | Threshold Voltage   | Vds = 3V, Ids = 4 mA   | V                     | 0.18                | 0.52 |      |
| Idss   | Saturated Drain Current                                     | Vds = 3V, Vgs = 0V   | $\mu\text{A}$         | —                   | 1    |      |
| Gm     | Transconductance  | Vds = 3V,<br>gm = $\Delta\text{Idss}/\Delta\text{Vgs}$ ;<br>$\Delta\text{Vgs} = 0.75 - 0.7 = 0.05\text{V}$ | mmho                  | 230                 | 410  |      |
| Igss   | Gate Leakage Current  | Vgd = Vgs = -3V  | $\mu\text{A}$         | —                   | 200  |      |
| NF     | Noise Figure <sup>[1]</sup>                                 | f = 2 GHz  | Vds = 3V, Ids = 30 mA | dB                  | —    | 0.5  |
|        |   | f = 900 MHz  | Vds = 3V, Ids = 30 mA | dB                  | —    | 0.3  |
|        |   | f = 2 GHz  | Vds = 4V, Ids = 30 mA | dB                  | —    | 0.5  |
|        |   | f = 900 MHz  | Vds = 4V, Ids = 30 mA | dB                  | —    | 0.3  |
| Ga     | Associated Gain <sup>[1]</sup>                              | f = 2 GHz  | Vds = 3V, Ids = 30 mA | dB                  | 15   | 16.5 |
|        |   | f = 900 MHz  | Vds = 3V, Ids = 30 mA | dB                  | —    | 23.1 |
|        |   | f = 2 GHz  | Vds = 4V, Ids = 30 mA | dB                  | —    | 17.7 |
|        |   | f = 900 MHz  | Vds = 4V, Ids = 30 mA | dB                  | —    | 22.5 |
| OIP3   | Output 3 <sup>rd</sup> Order Intercept Point <sup>[1]</sup> | f = 2 GHz  | Vds = 3V, Ids = 30 mA | dBm                 | 29   | 30.5 |
|        |   | f = 900 MHz  | Vds = 3V, Ids = 30 mA | dBm                 | —    | 28.6 |
|        |   | f = 2 GHz  | Vds = 4V, Ids = 30 mA | dBm                 | —    | 31.5 |
|        |   | f = 900 MHz  | Vds = 4V, Ids = 30 mA | dBm                 | —    | 31.0 |
| P1dB   | 1dB Compressed Output Power <sup>[1]</sup>                  | f = 2 GHz  | Vds = 3V, Ids = 30 mA | dBm                 | —    | 19   |
|        |   | f = 900 MHz  | Vds = 3V, Ids = 30 mA | dBm                 | —    | 18   |
|        |   | f = 2 GHz  | Vds = 4V, Ids = 30 mA | dBm                 | —    | 21   |
|        |   | f = 900 MHz  | Vds = 4V, Ids = 30 mA | dBm                 | —    | 19   |

Notes:

1. Measurements obtained using production test board described in Figure 5.
2. Typical values determined from a sample size of 500 parts from 3 wafers.

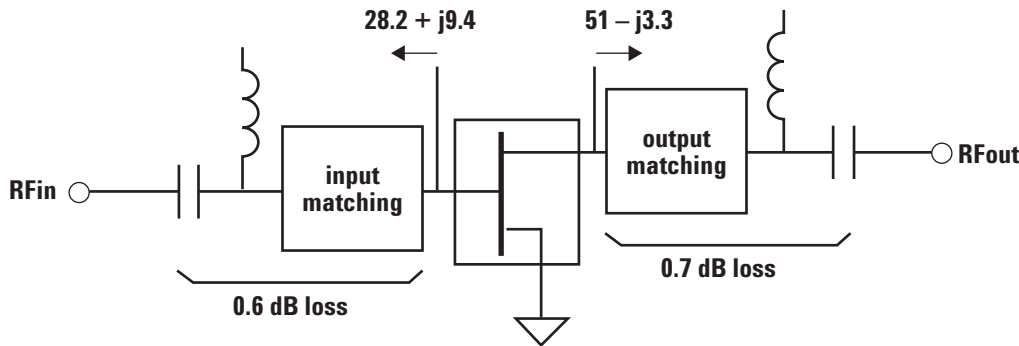
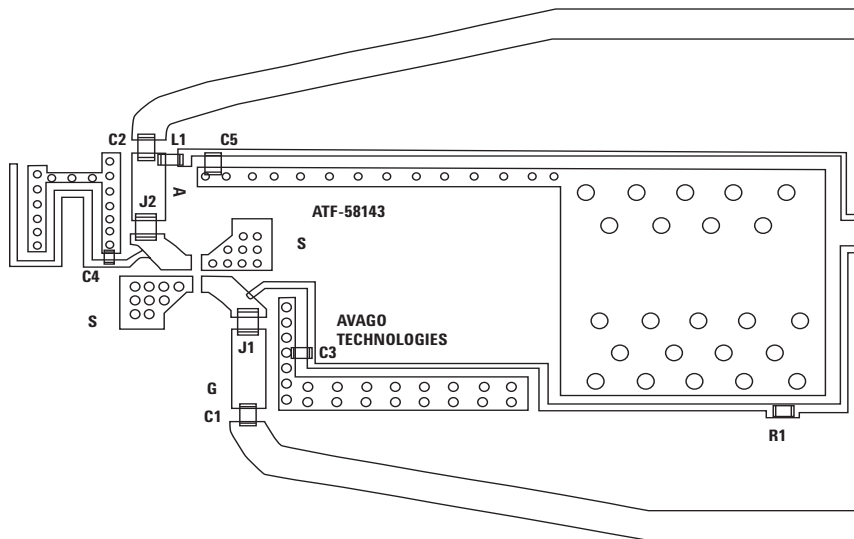

Figure 5. Block diagram of 2 GHz production test board used for Noise Figure, Associated Gain, P1dB and OIP3 measurements. This circuit represents a trade-off between an optimal noise match and associated impedance matching circuit losses.



- C1 : 2.7 pF Cap (0603)
- C2 : 1 pF Cap (0603)
- C3 : 1200 pF Cap (0603)
- C4 : 120 pF Cap (0402)
- C5 : 1200 pF Cap (0603)
- R1 : 49.9 Ohm (0603)
- L1 : 56 nH (0603)
- J1 : 0 Ohm, Jumper (0805)
- J2 : 0 Ohm, Jumper (0805)
- J3 : 0 Ohm, Jumper (0402)
- J4 : 0 Ohm, Jumper (0402)

Figure 6. Close-up of Production Test Board.

### ATF-58143 Typical Performance Curves

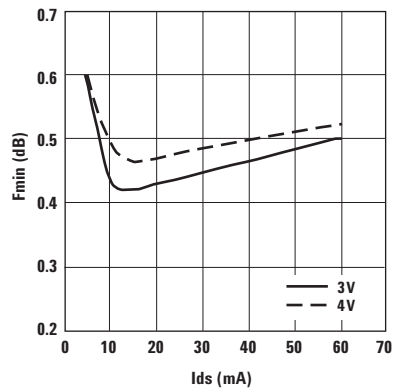

Figure 7. Fmin vs. Ids and Vds Tuned for Max OIP3 and Fmin at 2 GHz.

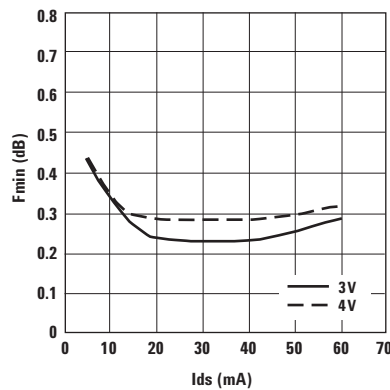

Figure 8. Fmin vs. Ids and Vds Tuned for Max OIP3 and Fmin at 900 MHz.

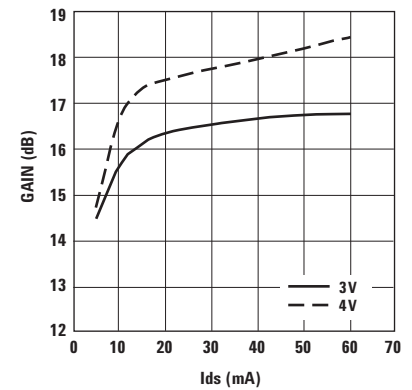

Figure 9. Gain vs. Ids and Vds Tuned for Max OIP3 and Fmin at 2 GHz.

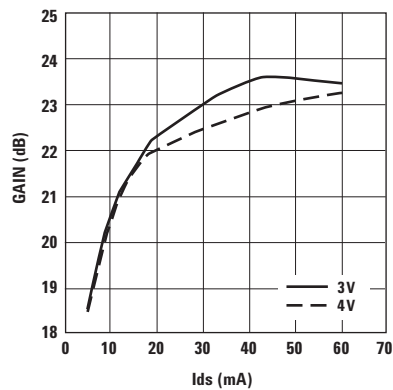

Figure 10. Gain vs. Ids and Vds Tuned for Max OIP3 and Fmin at 900 MHz.

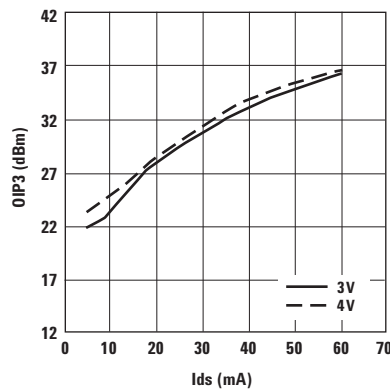

Figure 11. OIP3 vs. Ids and Vds Tuned for Max OIP3 and Fmin at 2 GHz.

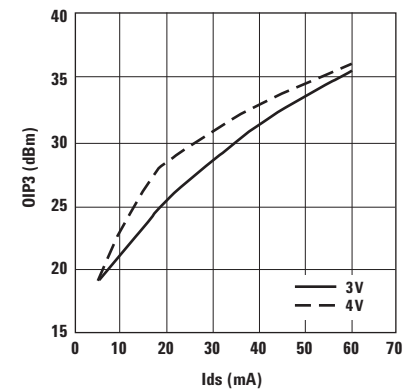

Figure 12. OIP3 vs. Ids and Vds Tuned for Max OIP3 and Fmin at 900 MHz.

## ATF-58143 Typical Performance Curves, continued

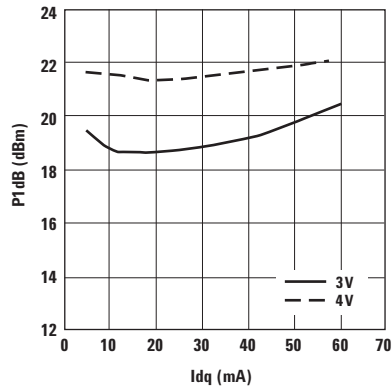

Figure 13. P1dB vs. Idq and Vds Tuned for Max OIP3 and Fmin at 2 GHz.<sup>[1]</sup>

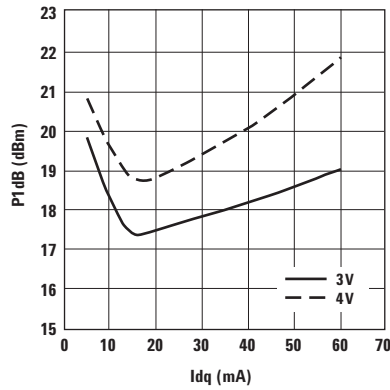

Figure 14. P1dB vs. Idq and Vds Tuned for Max OIP3 and Fmin at 900 MHz.<sup>[1]</sup>

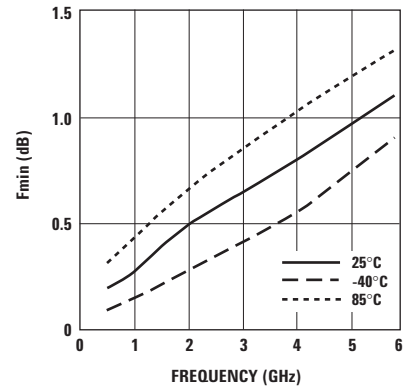

Figure 15. Fmin vs. Frequency and Temp. Tuned for Max OIP3 and Fmin at 3V, 30 mA.

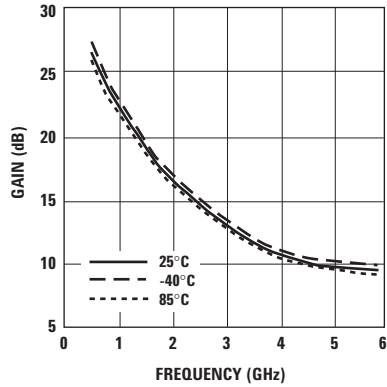

Figure 16. Gain vs. Frequency and Temp. Tuned for Max OIP3 and Fmin at 3V, 30 mA.

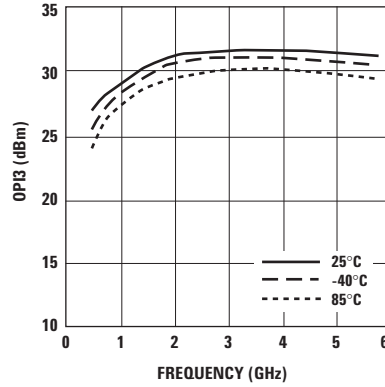

Figure 17. OIP3 vs. Frequency and Temp. Tuned for Max OIP3 and Fmin at 3V, 30 mA.

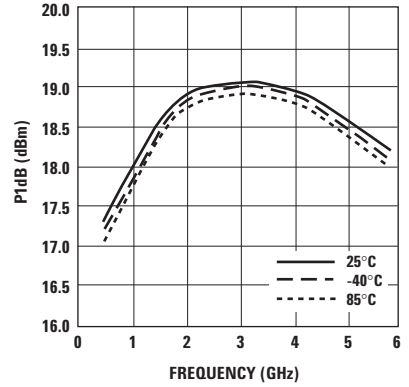

Figure 18. P1dB vs. Frequency and Temp. Tuned for Max OIP3 and Fmin at 3V, 30 mA.

### Note:

1. When plotting P1dB, the drain current was allowed to vary dependent on the RF input power.

**ATF-58143 Typical Scattering Parameters,  $V_{DS} = 3V, I_{DS} = 30\text{ mA}$**

| Freq.<br>GHz | $S_{11}$ |        |       | $S_{21}$ |        |        | $S_{12}$ |        | $S_{22}$ |        | MSG/MAG<br>dB |
|--------------|----------|--------|-------|----------|--------|--------|----------|--------|----------|--------|---------------|
|              | Mag.     | Ang.   | dB    | Mag.     | Ang.   | dB     | Mag.     | Ang.   | Mag.     | Ang.   |               |
| 0.1          | 0.98     | -17.1  | 27.29 | 23.14    | 168.7  | -40.10 | 0.010    | 80.8   | 0.67     | -12.1  | 33.69         |
| 0.5          | 0.81     | -92.0  | 25.25 | 18.31    | 123.7  | -28.10 | 0.039    | 45.7   | 0.42     | -46.6  | 26.68         |
| 0.9          | 0.75     | -126.4 | 21.87 | 12.40    | 103.4  | -26.12 | 0.049    | 34.8   | 0.32     | -66.7  | 23.99         |
| 1.0          | 0.73     | -132.2 | 21.18 | 11.46    | 99.8   | -25.87 | 0.051    | 33.4   | 0.31     | -72.3  | 23.52         |
| 1.5          | 0.69     | -153.2 | 18.38 | 8.31     | 85.1   | -24.70 | 0.058    | 29.4   | 0.25     | -90.8  | 21.54         |
| 1.9          | 0.66     | -165.9 | 16.74 | 6.88     | 75.4   | -23.86 | 0.064    | 27.4   | 0.23     | -103.6 | 20.30         |
| 2.0          | 0.65     | -169.3 | 16.40 | 6.61     | 73.1   | -23.65 | 0.066    | 26.9   | 0.22     | -106.0 | 20.03         |
| 2.5          | 0.63     | 176.3  | 14.83 | 5.51     | 61.9   | -22.71 | 0.073    | 24.4   | 0.19     | -118.1 | 18.77         |
| 3.0          | 0.61     | 160.7  | 13.51 | 4.74     | 50.9   | -21.87 | 0.081    | 21.1   | 0.17     | -133.3 | 17.69         |
| 3.5          | 0.61     | 147.4  | 12.35 | 4.15     | 40.4   | -21.10 | 0.088    | 17.7   | 0.15     | -145.4 | 16.73         |
| 4.0          | 0.62     | 133.8  | 11.28 | 3.66     | 30.2   | -20.45 | 0.095    | 13.5   | 0.13     | -155.7 | 15.86         |
| 4.5          | 0.64     | 123.7  | 10.32 | 3.28     | 20.5   | -19.86 | 0.102    | 9.3    | 0.13     | -175.4 | 15.09         |
| 5.0          | 0.66     | 112.5  | 9.41  | 2.96     | 11.1   | -19.39 | 0.107    | 4.9    | 0.13     | 166.2  | 14.40         |
| 5.5          | 0.68     | 103.7  | 8.61  | 2.70     | 2.1    | -18.87 | 0.114    | 0.7    | 0.14     | 152.8  | 13.74         |
| 6.0          | 0.69     | 93.0   | 7.84  | 2.47     | -7.3   | -18.44 | 0.120    | -4.4   | 0.14     | 140.7  | 13.14         |
| 7.0          | 0.71     | 77.2   | 6.47  | 2.11     | -24.8  | -17.63 | 0.131    | -14.6  | 0.17     | 120.7  | 12.06         |
| 8.0          | 0.74     | 58.3   | 5.14  | 1.81     | -43.1  | -17.13 | 0.139    | -26.1  | 0.19     | 95.4   | 11.14         |
| 9.0          | 0.78     | 39.7   | 3.77  | 1.54     | -60.7  | -16.67 | 0.147    | -37.0  | 0.24     | 70.1   | 10.22         |
| 10.0         | 0.84     | 25.1   | 2.55  | 1.34     | -78.8  | -16.21 | 0.155    | -50.2  | 0.34     | 52.4   | 9.39          |
| 11.0         | 0.87     | 10.2   | 1.25  | 1.16     | -97.1  | -16.04 | 0.158    | -64.2  | 0.41     | 37.3   | 8.65          |
| 12.0         | 0.89     | -3.9   | 0.19  | 1.02     | -114.0 | -15.72 | 0.164    | -78.3  | 0.46     | 21.5   | 7.96          |
| 13.0         | 0.90     | -20.0  | -1.09 | 0.88     | -132.2 | -15.86 | 0.161    | -93.6  | 0.52     | 2.5    | 7.39          |
| 14.0         | 0.93     | -31.4  | -2.53 | 0.75     | -148.3 | -16.22 | 0.154    | -106.5 | 0.58     | -14.1  | 6.85          |
| 15.0         | 0.96     | -43.9  | -4.00 | 0.63     | -162.8 | -16.73 | 0.146    | -118.2 | 0.66     | -26.0  | 6.36          |
| 16.0         | 0.94     | -54.2  | -5.46 | 0.53     | -176.5 | -17.15 | 0.139    | -128.6 | 0.72     | -36.3  | 5.85          |
| 17.0         | 0.96     | -65.1  | -7.14 | 0.44     | 168.6  | -17.68 | 0.131    | -142.4 | 0.74     | -49.0  | 5.27          |
| 18.0         | 0.93     | -79.8  | -8.81 | 0.36     | 153.8  | -18.36 | 0.121    | -155.6 | 0.77     | -64.8  | 4.77          |

**Typical Noise Parameters,  $V_{DS} = 3V, I_{DS} = 30\text{ mA}$**

| Freq<br>GHz | $F_{min}$<br>dB | $\Gamma_{opt}$<br>Mag. | $\Gamma_{opt}$<br>Ang. | $R_{n/50}$ | $G_a$<br>dB |
|-------------|-----------------|------------------------|------------------------|------------|-------------|
| 0.5         | 0.12            | 0.39                   | 17.775                 | 0.04       | 25.33       |
| 0.9         | 0.18            | 0.37                   | 46.9                   | 0.04       | 22.26       |
| 1.0         | 0.20            | 0.36                   | 53.525                 | 0.04       | 21.54       |
| 1.5         | 0.32            | 0.32                   | 80                     | 0.04       | 19.16       |
| 1.9         | 0.43            | 0.30                   | 101                    | 0.04       | 17.65       |
| 2.0         | 0.45            | 0.30                   | 107.7                  | 0.04       | 17.33       |
| 2.4         | 0.51            | 0.29                   | 125.2                  | 0.04       | 16.23       |
| 3.0         | 0.58            | 0.31                   | 154.475                | 0.05       | 14.77       |
| 3.9         | 0.75            | 0.35                   | -156.95                | 0.06       | 13.39       |
| 5.0         | 0.87            | 0.42                   | -120.93                | 0.09       | 11.92       |
| 5.8         | 1.01            | 0.50                   | -100.83                | 0.15       | 11.07       |
| 6.0         | 1.04            | 0.53                   | -97.15                 | 0.18       | 10.93       |

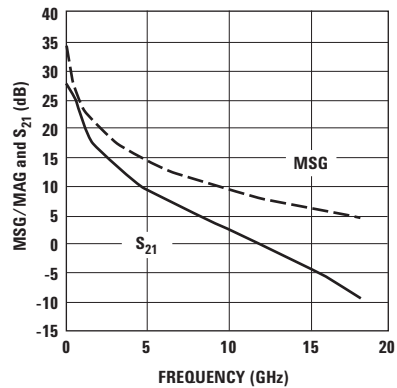

**Figure 19. MSG/MAG and  $S_{21}$  vs. Frequency at 3V, 30 mA.**

Notes:

- $F_{min}$  values at 2 GHz and higher are based on measurements while the  $F_{min}$  below 2 GHz have been extrapolated. The  $F_{min}$  values are based on a set of 16 noise figure measurements made at 16 different impedances using an ATN NP5 test system. From these measurements  $F_{min}$  is calculated. Refer to the noise parameter application section for more information.
- S and noise parameters are measured on a microstrip line made on 0.025 inch thick alumina carrier. The input reference plane is at the end of the gate lead. The output reference plane is at the end of the drain lead. The parameters include the effect of four plated through via holes connecting source landing pads on top of the test carrier to the microstrip ground plane on the bottom side of the carrier. Two 0.020 inch diameter via holes are placed within 0.010 inch from each source lead contact point, one via on each side of that point.

**ATF-58143 Typical Scattering Parameters,  $V_{DS} = 4V, I_{DS} = 30\text{ mA}$**

| Freq.<br>GHz | $S_{11}$ |        |       | $S_{21}$ |         |        | $S_{12}$ |        | $S_{22}$ |         | MSG/MAG<br>dB |
|--------------|----------|--------|-------|----------|---------|--------|----------|--------|----------|---------|---------------|
|              | Mag.     | Ang.   | dB    | Mag.     | Ang.    | dB     | Mag.     | Ang.   | Mag.     | Ang.    |               |
| 0.1          | 0.99     | -16.3  | 28.16 | 25.6     | 169.65  | -41.08 | 0.01     | 81.1   | 0.65     | -10.17  | 34.62         |
| 0.5          | 0.83     | -94.5  | 25.82 | 19.5     | 125.68  | -28.95 | 0.04     | 46.2   | 0.45     | -54.83  | 27.39         |
| 0.9          | 0.76     | -133.1 | 22.52 | 13.4     | 104.58  | -27.00 | 0.04     | 33.9   | 0.33     | -76.45  | 24.76         |
| 1            | 0.75     | -139.7 | 21.83 | 12.3     | 100.73  | -26.74 | 0.05     | 32.0   | 0.31     | -80.28  | 24.29         |
| 1.5          | 0.72     | -162.2 | 18.94 | 8.9      | 85.42   | -25.79 | 0.05     | 26.9   | 0.24     | -95.17  | 22.37         |
| 1.9          | 0.71     | -172.7 | 17.18 | 7.2      | 75.68   | -25.25 | 0.05     | 24.8   | 0.21     | -104.27 | 21.21         |
| 2            | 0.70     | -174.9 | 16.79 | 6.9      | 73.47   | -25.09 | 0.06     | 24.4   | 0.21     | -106.18 | 20.94         |
| 2.5          | 0.69     | 173.5  | 14.67 | 5.4      | 59.58   | -24.15 | 0.06     | 21.7   | 0.18     | -117.35 | 19.41         |
| 3            | 0.68     | 161.6  | 13.05 | 4.5      | 46.88   | -23.33 | 0.07     | 19.0   | 0.16     | -124.85 | 18.19         |
| 4            | 0.67     | 141.9  | 11.00 | 3.5      | 28.55   | -22.14 | 0.08     | 14.1   | 0.13     | -137.33 | 16.57         |
| 5            | 0.69     | 123.1  | 9.29  | 2.9      | 10.32   | -21.13 | 0.09     | 7.3    | 0.12     | -42.65  | 15.21         |
| 6            | 0.73     | 108.9  | 7.73  | 2.4      | -7.48   | -20.28 | 0.10     | -1.3   | 0.13     | 158.73  | 14.00         |
| 7            | 0.76     | 96.3   | 6.16  | 2.0      | -23.78  | -19.80 | 0.10     | -9.7   | 0.17     | 125.87  | 12.98         |
| 8            | 0.79     | 82.4   | 4.74  | 1.7      | -39.33  | -19.32 | 0.11     | -16.9  | 0.20     | 104.88  | 12.03         |
| 9            | 0.82     | 71.2   | 3.63  | 1.5      | -55.93  | -18.49 | 0.12     | -26.7  | 0.25     | 83.12   | 11.06         |
| 10           | 0.85     | 60.1   | 2.63  | 1.4      | -73.30  | -17.74 | 0.13     | -39.3  | 0.31     | 61.03   | 10.19         |
| 11           | 0.87     | 47.2   | 1.52  | 1.2      | -90.53  | -17.31 | 0.14     | -52.2  | 0.38     | 41.33   | 9.42          |
| 12           | 0.89     | 36.2   | 0.38  | 1.0      | -106.67 | -17.12 | 0.14     | -64.5  | 0.44     | 22.65   | 8.75          |
| 13           | 0.91     | 26.6   | -0.80 | 0.9      | -121.58 | -17.09 | 0.14     | -75.2  | 0.49     | 6.28    | 8.15          |
| 14           | 0.93     | 17.2   | -2.01 | 0.8      | -135.15 | -17.15 | 0.14     | -84.2  | 0.54     | -7.48   | 7.57          |
| 15           | 0.94     | 9.2    | -3.24 | 0.7      | -148.98 | -17.22 | 0.14     | -94.3  | 0.59     | -22.78  | 6.99          |
| 16           | 0.94     | 1.2    | -4.43 | 0.6      | -164.25 | -17.36 | 0.14     | -106.1 | 0.64     | -39.22  | 6.46          |
| 17           | 0.92     | -10.5  | -5.79 | 0.5      | -59.55  | -17.68 | 0.13     | -119.3 | 0.68     | -53.35  | 5.94          |
| 18           | 0.91     | 17.6   | -6.74 | 0.5      | 170.70  | -17.94 | 0.13     | -127.5 | 0.69     | -71.73  | 5.60          |

**Typical Noise Parameters,  $V_{DS} = 4V, I_{DS} = 30\text{ mA}$**

| Freq<br>GHz | $F_{min}$<br>dB | $\Gamma_{opt}$<br>Mag. | $\Gamma_{opt}$<br>Ang. | $R_{n/50}$ | $G_a$<br>dB |
|-------------|-----------------|------------------------|------------------------|------------|-------------|
| 0.5         | 0.14            | 0.38                   | 9.7                    | 0.03       | 24.85       |
| 0.9         | 0.23            | 0.36                   | 44.4                   | 0.04       | 22.21       |
| 1.0         | 0.25            | 0.35                   | 54.0                   | 0.04       | 21.51       |
| 1.5         | 0.35            | 0.32                   | 78.7                   | 0.04       | 19.21       |
| 1.9         | 0.47            | 0.3                    | 100.7                  | 0.04       | 17.71       |
| 2.0         | 0.49            | 0.3                    | 105.4                  | 0.04       | 17.39       |
| 2.4         | 0.55            | 0.28                   | 124.0                  | 0.04       | 16.25       |
| 3.0         | 0.61            | 0.3                    | 153.9                  | 0.05       | 14.86       |
| 3.9         | 0.78            | 0.35                   | -157.2                 | 0.07       | 13.51       |
| 5.0         | 0.91            | 0.42                   | -120.8                 | 0.1        | 12.05       |
| 5.8         | 1.05            | 0.49                   | -101.2                 | 0.16       | 11.14       |
| 6.0         | 1.11            | 0.53                   | -97.4                  | 0.19       | 11.14       |

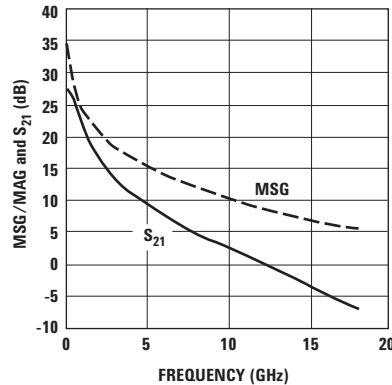

**Figure 20. MSG/MAG and  $S_{21}$  vs. Frequency at 4V, 30 mA.**

Notes:

- $F_{min}$  values at 2 GHz and higher are based on measurements while the  $F_{min}$  below 2 GHz have been extrapolated. The  $F_{min}$  values are based on a set of 16 noise figure measurements made at 16 different impedances using an ATN NP5 test system. From these measurements  $F_{min}$  is calculated. Refer to the noise parameter application section for more information.
- S and noise parameters are measured on a microstrip line made on a 0.025 inch thick alumina carrier. The input reference plane is at the end of the gate lead. The output reference plane is at the end of the drain lead. The parameters include the effect of four plated through via holes connecting source landing pads on top of the test carrier to the microstrip ground plane on the bottom side of the carrier. Two 0.020 inch diameter via holes are placed within 0.010 inch from each source lead contact point, one via on each side of that point.

## Ordering Information

| Part Number    | No. of Devices | Container      |
|----------------|----------------|----------------|
| ATF-58143-TR1G | 3000           | 7" Reel        |
| ATF-58143-TR2G | 10000          | 13" Reel       |
| ATF-58143-BLKG | 100            | antistatic bag |

## Package Dimensions Outline 43 (SOT-343/SC70 4 lead)

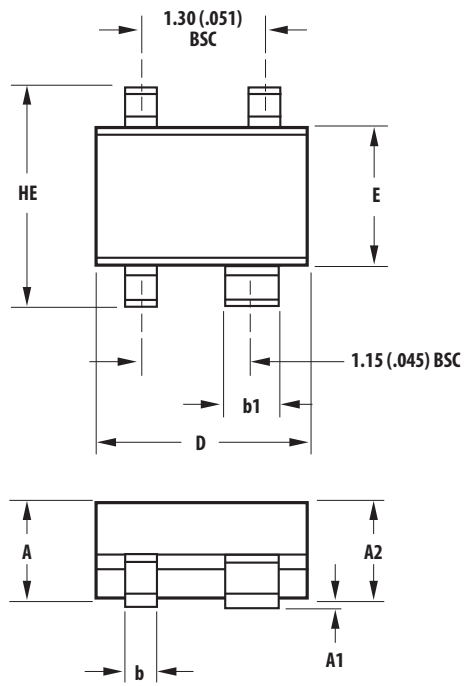

| SYMBOL | DIMENSIONS (mm) |      |
|--------|-----------------|------|
|        | MIN.            | MAX. |
| E      | 1.15            | 1.35 |
| D      | 1.85            | 2.25 |
| HE     | 1.80            | 2.40 |
| A      | 0.80            | 1.10 |
| A2     | 0.80            | 1.00 |
| A1     | 0.00            | 0.10 |
| b      | 0.15            | 0.40 |
| b1     | 0.55            | 0.70 |
| c      | 0.10            | 0.20 |
| L      | 0.10            | 0.46 |

## Recommended PCB Pad Layout for Avago's SC70 4L/SOT-343 Products

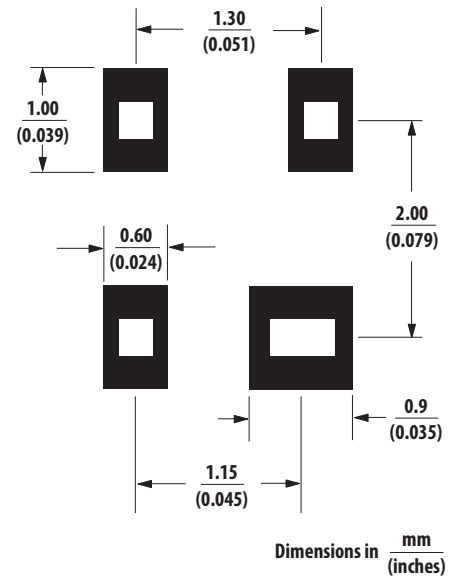

### NOTES:

1. All dimensions are in mm.
2. Dimensions are inclusive of plating.
3. Dimensions are exclusive of mold flash & metal burr.
4. All specifications comply to EIAJ SC70.
5. Die is facing up for mold and facing down for trim/form, ie: reverse trim/form.
6. Package surface to be mirror finish.



## Device Orientation

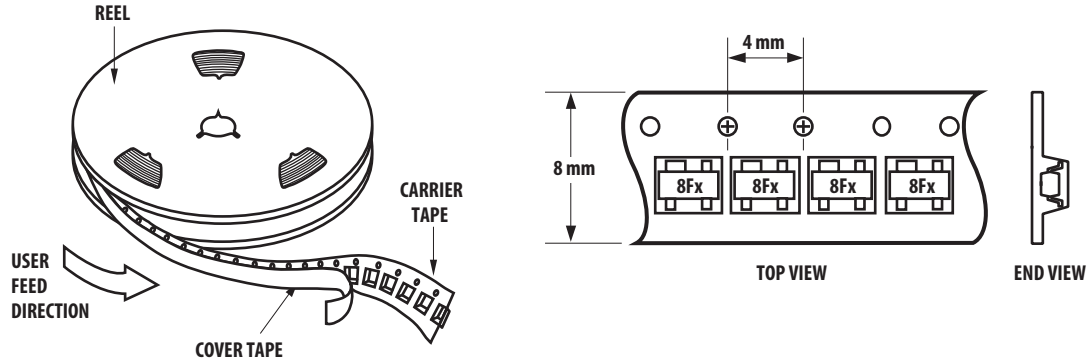

## Tape Dimensions For Outline 4T

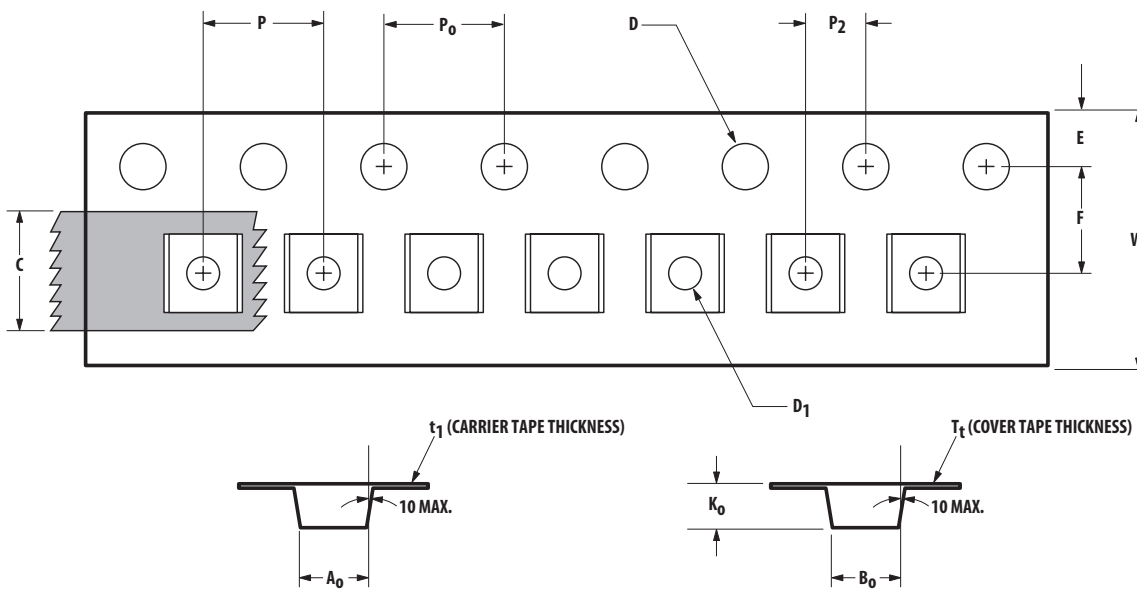

| DESCRIPTION  |  | SYMBOL | SIZE (mm)            | SIZE (INCHES)       |
|--------------|--|--------|----------------------|---------------------|
| CAVITY       | LENGTH                                   | $A_0$  | $2.40 \pm 0.10$      | $0.094 \pm 0.004$   |
|              | WIDTH                                    | $B_0$  | $2.40 \pm 0.10$      | $0.094 \pm 0.004$   |
|              | DEPTH                                    | $K_0$  | $1.20 \pm 0.10$      | $0.047 \pm 0.004$   |
|              | PITCH                                    | $P$    | $4.00 \pm 0.10$      | $0.157 \pm 0.004$   |
|              | BOTTOM HOLE DIAMETER                     | $D_1$  | $1.00 + 0.25$        | $0.039 + 0.010$     |
| PERFORATION  | DIAMETER                                 | $D$    | $1.55 \pm 0.10$      | $0.061 + 0.002$     |
|              | PITCH                                    | $P_0$  | $4.00 \pm 0.10$      | $0.157 \pm 0.004$   |
|              | POSITION                                 | $E$    | $1.75 \pm 0.10$      | $0.069 \pm 0.004$   |
| CARRIER TAPE | WIDTH                                    | $W$    | $8.00 + 0.30 - 0.10$ | $0.315 + 0.012$     |
|              | THICKNESS                                | $t_1$  | $0.254 \pm 0.02$     | $0.0100 \pm 0.0008$ |
| COVER TAPE   | WIDTH                                    | $C$    | $5.40 \pm 0.10$      | $0.205 \pm 0.004$   |
|              | TAPE THICKNESS                           | $T_t$  | $0.062 \pm 0.001$    | $0.0025 \pm 0.0004$ |
| DISTANCE     | CAVITY TO PERFORATION (WIDTH DIRECTION)  | $F$    | $3.50 \pm 0.05$      | $0.138 \pm 0.002$   |
|              | CAVITY TO PERFORATION (LENGTH DIRECTION) | $P_2$  | $2.00 \pm 0.05$      | $0.079 \pm 0.002$   |

For product information and a complete list of distributors, please go to our web site: [www.avagotech.com](http://www.avagotech.com)

Avago, Avago Technologies, and the A logo are trademarks of Avago Technologies in the United States and other countries. Data subject to change. Copyright © 2005-2012 Avago Technologies. All rights reserved. Obsoletes 5989-3749EN AV02-0672EN - June 8, 2012

**AVAGO**  
TECHNOLOGIES