

## N-Channel Enhancement-Mode Vertical DMOS FET

### Features

- Free from Secondary Breakdown
- Low Power Drive Requirement
- Ease of Paralleling
- Low  $C_{ISS}$  and Fast Switching Speeds
- Excellent Thermal Stability
- Integral Source-drain Diode
- High Input Impedance and High Gain

### Applications

- Motor Controls
- Converters
- Amplifiers
- Switches
- Power Supply Circuits
- Drivers (Relays, Hammers, Solenoids, Lamps, Memory, Displays, Bipolar Transistors, etc.)

### General Description

VN2210 is an Enhancement-mode (normally-off) transistor that utilizes a vertical Double-diffused Metal-Oxide Semiconductor (DMOS) structure and a well-proven silicon gate manufacturing process. This combination produces a device with the power handling capabilities of bipolar transistors as well as the high input impedance and positive temperature coefficient inherent in MOS devices. Characteristic of all MOS structures, this device is free from thermal runaway and thermally induced secondary breakdown.

Vertical DMOS Field-Effect Transistors (FETs) are ideally suited to a wide range of switching and amplifying applications where high breakdown voltage, high input impedance, low input capacitance and fast switching speeds are desired.

### Package Types

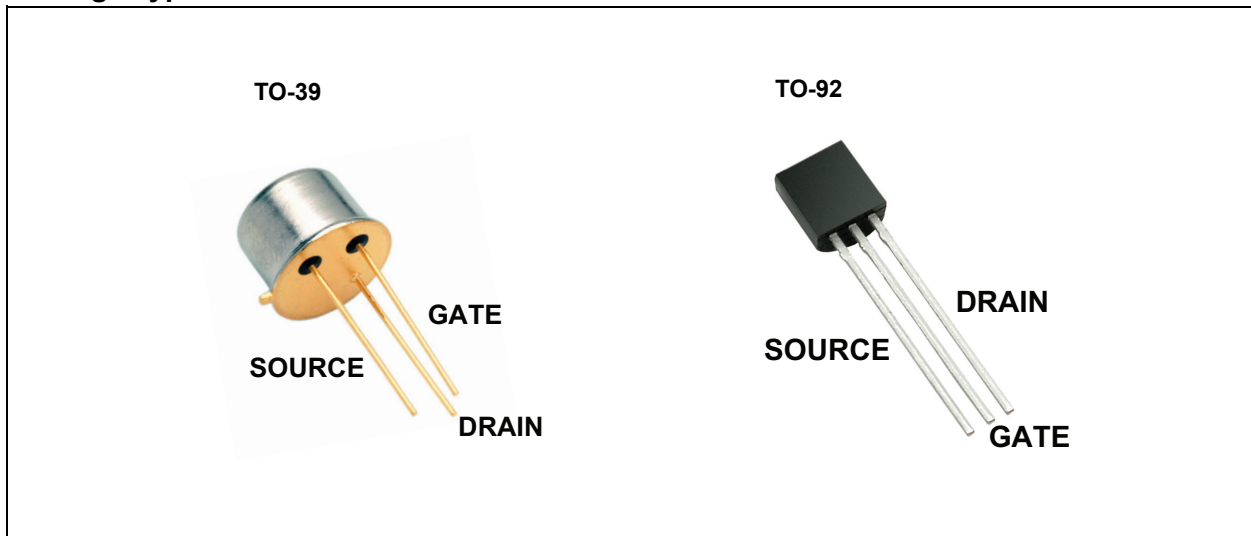

# VN2210

## 1.0 ELECTRICAL CHARACTERISTICS

### Absolute Maximum Ratings †

Drain-to-source Voltage .....	$BV_{DSS}$
Drain-to-gate Voltage .....	$BV_{DGS}$
Gate-to-source Voltage .....	$\pm 20V$
Operating and Storage Temperatures .....	$-55^{\circ}C$ to $+150^{\circ}C$

† **Notice:** Stresses above those listed under “Absolute Maximum Ratings” may cause permanent damage to the device. This is a stress rating only, and functional operation of the device at those or any other conditions above those indicated in the operational sections of this specification is not intended. Exposure to maximum rating conditions for extended periods may affect device reliability.

### ELECTRICAL CHARACTERISTICS

Electrical Specifications: $T_A = 25^{\circ}C$ unless otherwise specified.						
Parameters	Sym.	Min.	Typ.	Max.	Units	Conditions
<b>DC PARAMETERS (Note 1 unless otherwise specified)</b>						
Drain-to-source Breakdown Voltage	$BV_{DSS}$	100	—	—	V	$V_{GS} = 0V, I_D = 10\text{ mA}$
Gate Threshold Voltage	$V_{GS(th)}$	0.8	—	2.4	V	$V_{GS} = V_{DS}, I_D = 10\text{ mA}$
Change in $V_{GS(th)}$ with Temperature	$\Delta V_{GS(th)}$	—	-4.3	-5.5	mV/ $^{\circ}C$	$V_{GS} = V_{DS}, I_D = 10\text{ mA}$ (Note 2)
Gate Body Leakage Current	$I_{GSS}$	—	—	100	nA	$V_{GS} = \pm 20V, V_{DS} = 0V$
Zero Gate Voltage Drain Current	$I_{DSS}$	—	—	50	$\mu A$	$V_{GS} = 0V, V_{DS} = \text{Maximum rating}$
		—	—	10	mA	$V_{DS} = 0.8$ maximum rating, $V_{GS} = 0V, T_A = 125^{\circ}C$ (Note 2)
ON-State Drain Current	$I_{D(ON)}$	3	4.5	—	A	$V_{GS} = 5V, V_{DS} = 25V$
		8	17	—		$V_{GS} = 10V, V_{DS} = 25V$
Static Drain-to-source ON-State Resistance	$R_{DS(ON)}$	—	0.4	0.5	$\Omega$	$V_{GS} = 5V, I_D = 1A$
		—	0.27	0.35		$V_{GS} = 10V, I_D = 4A$
Change in $R_{DS(ON)}$ with Temperature	$\Delta R_{DS(ON)}$	—	0.85	1.2	$\%/^{\circ}C$	$V_{GS} = 10V, I_D = 4A$ (Note 2)
<b>AC PARAMETERS (Note 2)</b>						
Forward Transconductance	$G_{FS}$	1200	—	—	mmho	$V_{DS} = 25V, I_D = 2A$
Input Capacitance	$C_{ISS}$	—	300	500	pF	$V_{GS} = 0V, V_{DS} = 25V, f = 1\text{ MHz}$
Common Source Output Capacitance	$C_{OSS}$	—	125	200		
Reverse Transfer Capacitance	$C_{RSS}$	—	50	65		
Turn-on Time	$t_{d(ON)}$	—	10	15	ns	$V_{DD} = 25V, I_D = 2A, R_{GEN} = 10\Omega$
Rise Time	$t_r$	—	10	15		
Turn-off Time	$t_{d(OFF)}$	—	50	65		
Fall Time	$t_f$	—	30	50		
<b>DIODE PARAMETERS</b>						
Diode Forward Voltage Drop	$V_{SD}$	—	1	1.6	V	$V_{GS} = 0V, I_{SD} = 4A$ (Note 1)
Reverse Recovery Time	$t_{rr}$	—	500	—	ns	$V_{GS} = 0V, I_{SD} = 1A$ (Note 2)

**Note 1:** All DC parameters are 100% tested at  $25^{\circ}C$  unless otherwise stated.  
(Pulse test: 300  $\mu s$  pulse, 2% duty cycle)

**2:** Specification is obtained by characterization and is not 100% tested.

## TEMPERATURE SPECIFICATIONS

Electrical Characteristics: Unless otherwise specified, for all specifications $T_A = T_J = +25^\circ\text{C}$ .						
Parameters	Sym.	Min.	Typ.	Max.	Units	Conditions
<b>TEMPERATURE RANGES</b>						
Operating Temperature	$T_A$	-55	—	+150	$^\circ\text{C}$	
Storage Temperature	$T_S$	-55	—	+150	$^\circ\text{C}$	
<b>PACKAGE THERMAL RESISTANCES</b>						
TO-39	$\theta_{JA}$	—	N/A	—	—	
TO-92	$\theta_{JA}$	—	132	—	$^\circ\text{C/W}$	

## THERMAL CHARACTERISTICS

Package	$I_D$ (Note 1) (Continuous) (A)	$I_D$ (Pulsed) (A)	Power Dissipation at $T_C = 25^\circ\text{C}$ (W)	$I_{DR}$ (Note 1) (A)	$I_{DRM}$ (A)
TO-39	1.7	10	0.36	1.7	10
TO-92	1.2	8	0.74	1.2	8

**Note 1:**  $I_D$  (continuous) is limited by maximum  $T_j$ .

## 2.0 TYPICAL PERFORMANCE CURVES

**Note:** The graphs and tables provided following this note are a statistical summary based on a limited number of samples and are provided for informational purposes only. The performance characteristics listed herein are not tested or guaranteed. In some graphs or tables, the data presented may be outside the specified operating range (e.g. outside specified power supply range) and therefore outside the warranted range.

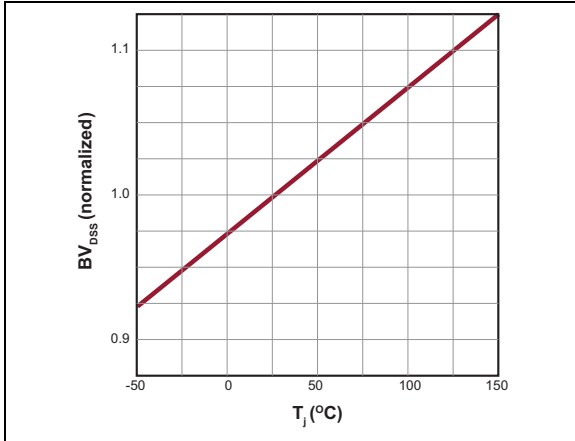

**FIGURE 2-1:**  $BV_{DSS}$  Variation with Temperature.

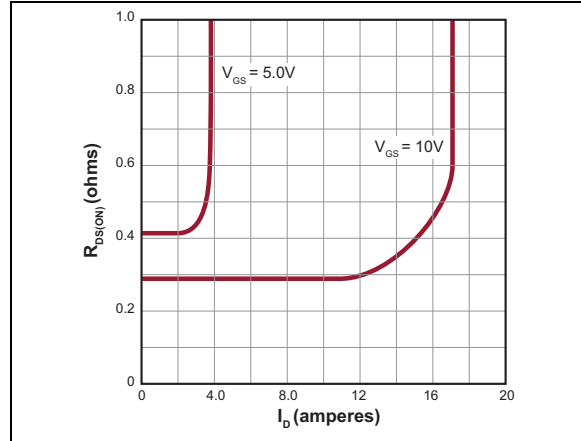

**FIGURE 2-4:** On-resistance vs. Drain Current.

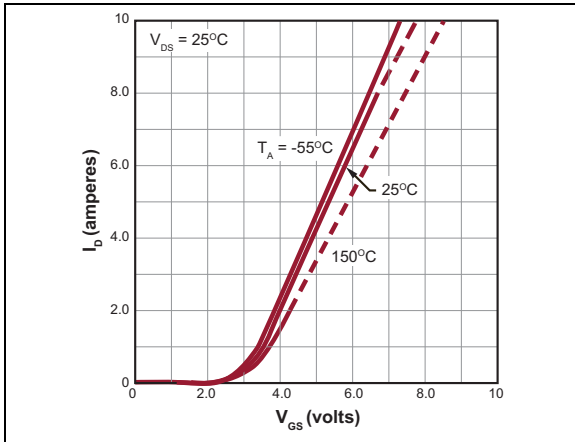

**FIGURE 2-2:** Transfer Characteristics.

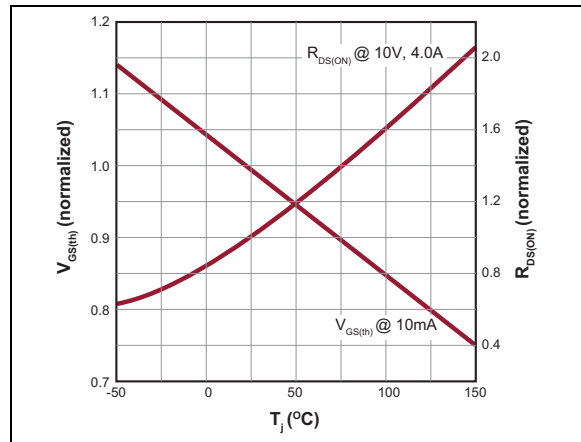

**FIGURE 2-5:**  $V_{GS}$  and  $R_{DS}$  Variation with Temperature.

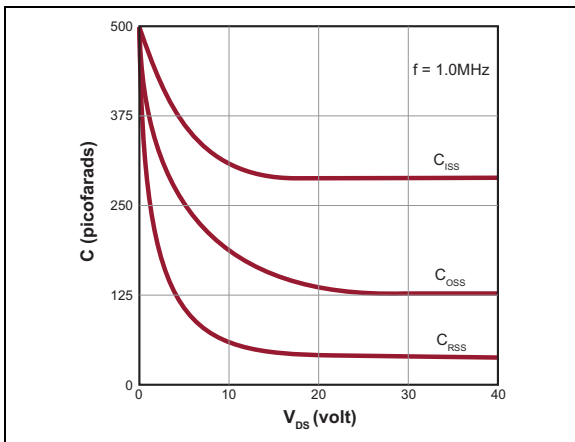

**FIGURE 2-3:** Capacitance vs. Drain-to-source Voltage.

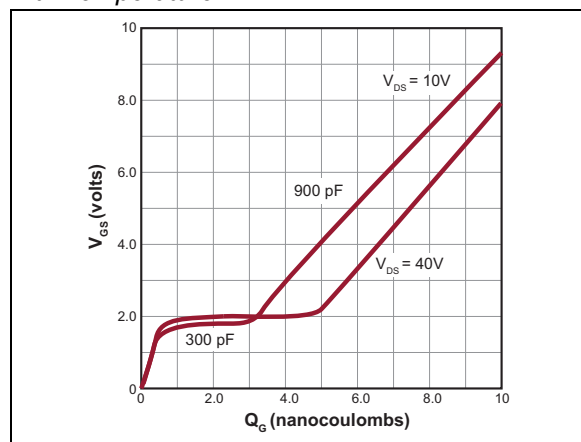

**FIGURE 2-6:** Gate Drive Dynamic Characteristics.

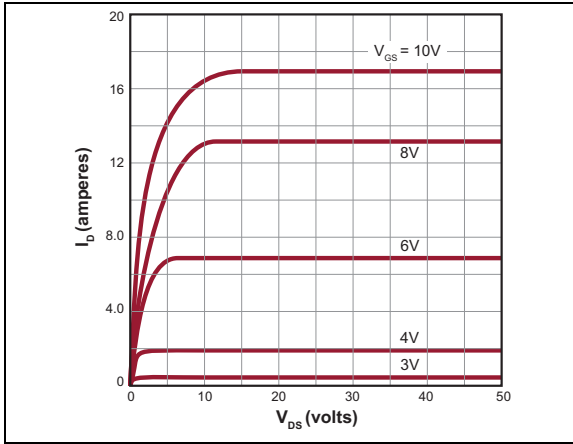

**FIGURE 2-7:** Output Characteristics.

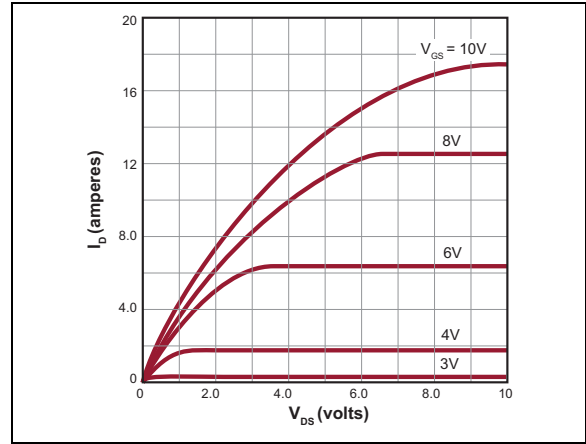

**FIGURE 2-10:** Saturation Characteristics.

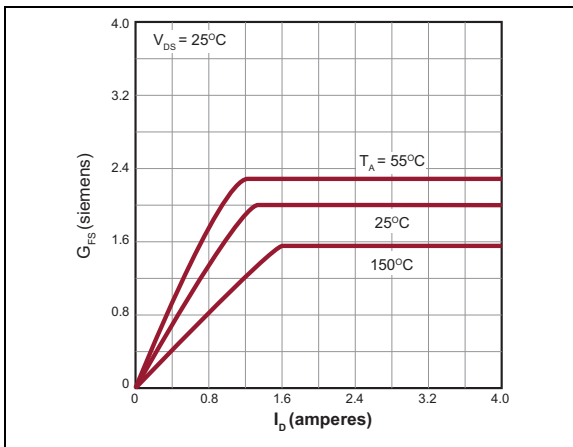

**FIGURE 2-8:** Transconductance vs. Drain Current.

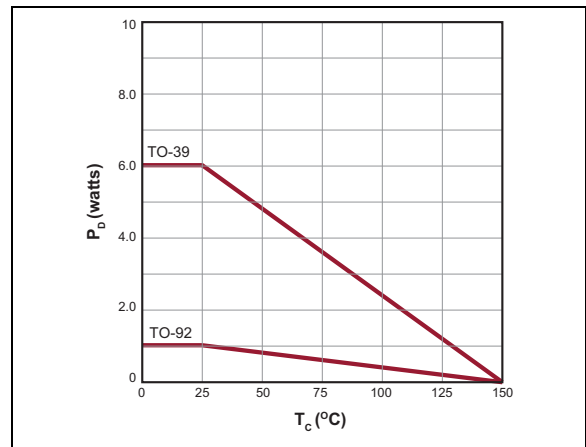

**FIGURE 2-11:** Power Dissipation vs. Case Temperature.

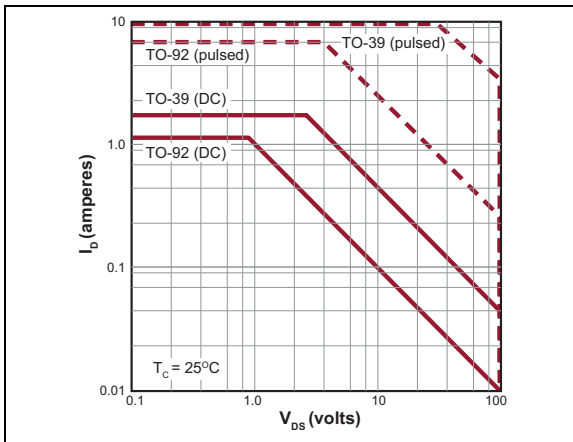

**FIGURE 2-9:** Maximum Rated Safe Operating Area.

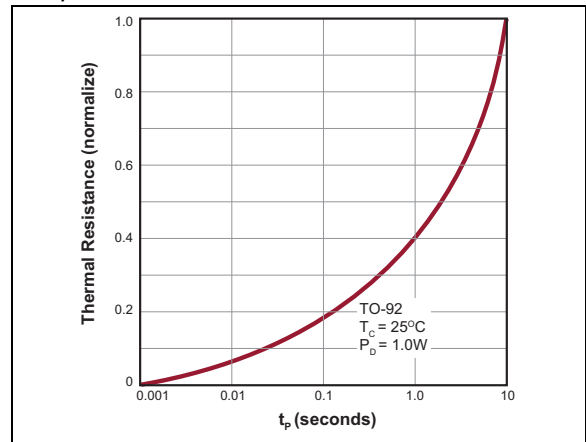

**FIGURE 2-12:** Thermal Response Characteristics.

# VN2210

---

## 3.0 PIN DESCRIPTION

Table 3-1 shows the description of pins in TO-39 and TO-92.

**TABLE 3-1: TO-39/TO-92 PIN FUNCTION TABLE**

Pin Number	TO-39	TO-92	Description
1	Source	Source	Source
2	Gate	Gate	Gate
3	Drain	Drain	Drain

## 4.0 FUNCTIONAL DESCRIPTION

Figure 4-1 illustrates the switching waveforms and test circuit for VN2210.

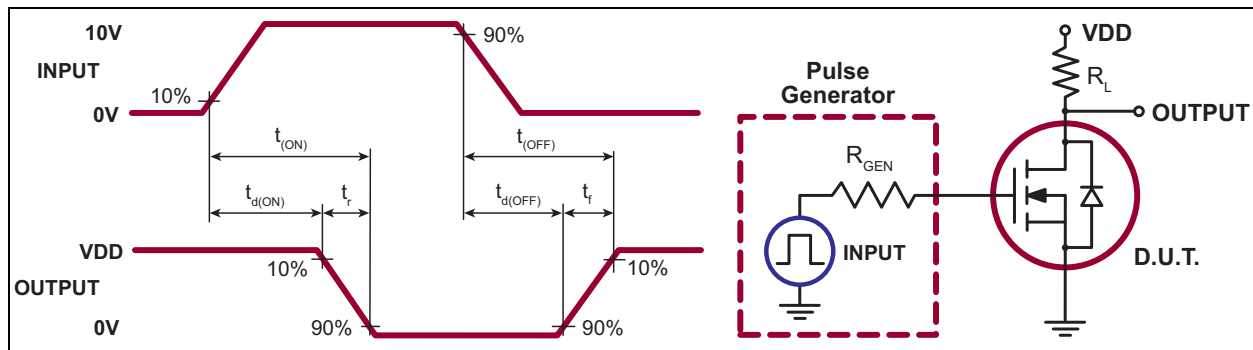

**FIGURE 4-1:** Switching Waveforms and Test Circuit.

## PRODUCT SUMMARY

$BV_{DSS}/BV_{DGS}$ (V)	$R_{DS(ON)}$ (Maximum) ( $\Omega$ )	$V_{GS(th)}$ (Maximum) (V)
100	0.35	2.4

# VN2210

## 5.0 PACKAGING INFORMATION

### 5.1 Package Marking Information

3-Lead TO-39

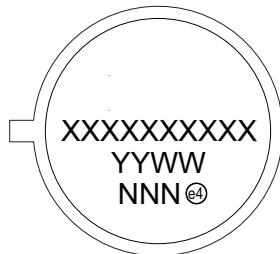

Example

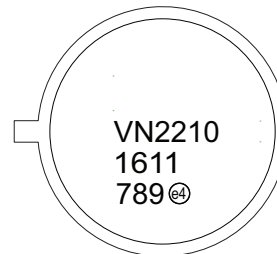

3-lead TO-92

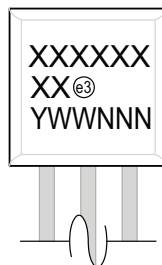

Example

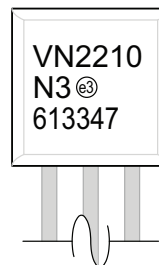

<b>Legend:</b>	XX...X	Product Code or Customer-specific information
	Y	Year code (last digit of calendar year)
	YY	Year code (last 2 digits of calendar year)
	WW	Week code (week of January 1 is week '01')
	NNN	Alphanumeric traceability code
	e3	Pb-free JEDEC <sup>®</sup> designator for Matte Tin (Sn)
	*	This package is Pb-free. The Pb-free JEDEC designator (e3) can be found on the outer packaging for this package.
	e4	Pre-plated
<b>Note:</b>	In the event the full Microchip part number cannot be marked on one line, it will be carried over to the next line, thus limiting the number of available characters for product code or customer-specific information. Package may or not include the corporate logo.	



## 3-Lead TO-39 Package Outline (N2)

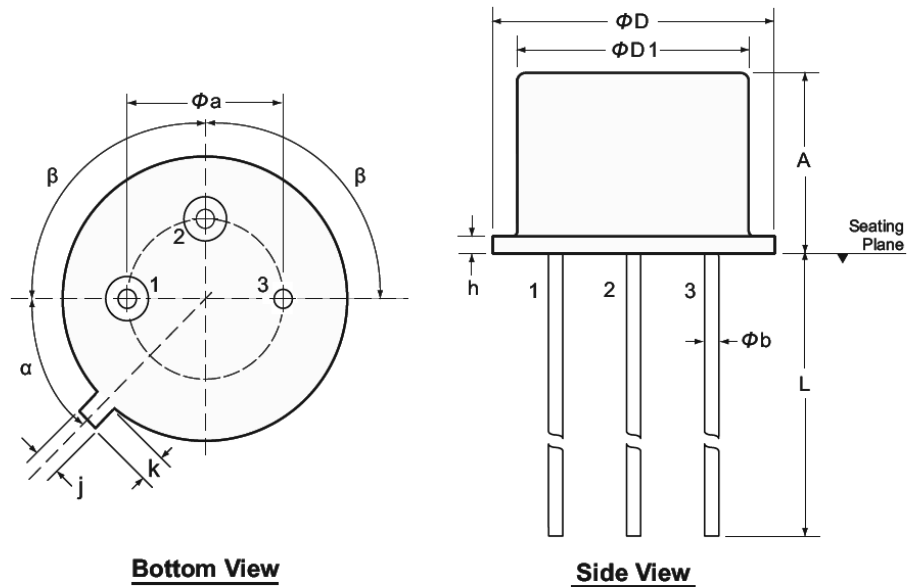

Note: For the most current package drawings, see the Microchip Packaging Specification at [www.microchip.com/packaging](http://www.microchip.com/packaging).

Symbol		$\alpha$	$\beta$	A	$\phi a$	$\phi b$	$\phi D$	$\phi D1$	h	j	k	L
Dimension (inches)	MIN	45° NOM	90° NOM	.240	.190	.016	.350	.315	.009	.028	.029	.500
	NOM			-	-	-	-	-	-	-	-	-
	MAX			.260	.210	.021	.370	.335	.125	.034	.040	.560*

JEDEC Registration TO-39.

\* This dimension is not specified in the JEDEC drawing.

Drawings not to scale.

## 3-Lead TO-92 Package Outline (L/LL/N3)

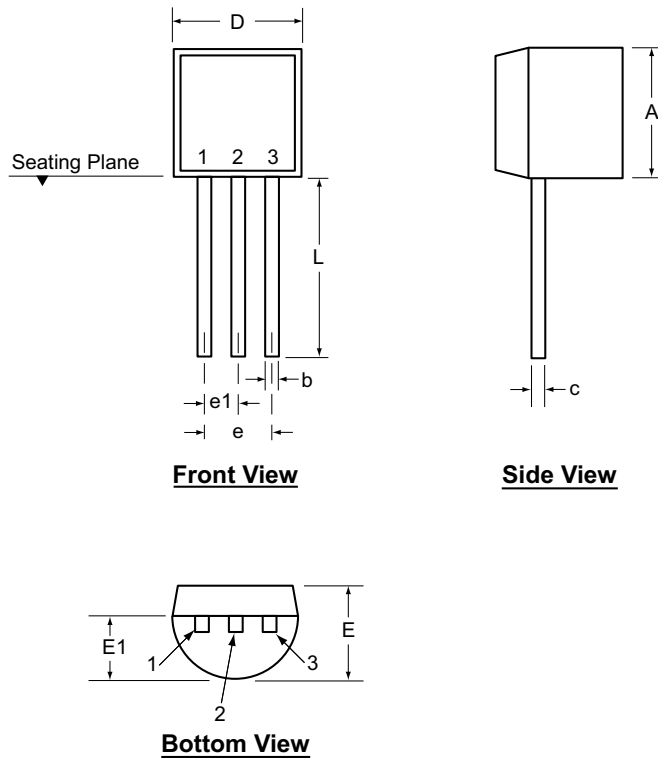

Note: For the most current package drawings, see the Microchip Packaging Specification at [www.microchip.com/packaging](http://www.microchip.com/packaging).

Symbol	A	b	c	D	E	E1	e	e1	L	
Dimensions (inches)	MIN	.170	.014 <sup>†</sup>	.014 <sup>†</sup>	.175	.125	.080	.095	.045	.500
	NOM	-	-	-	-	-	-	-	-	-
	MAX	.210	.022 <sup>†</sup>	.022 <sup>†</sup>	.205	.165	.105	.105	.055	.610*

JEDEC Registration TO-92.

\* This dimension is not specified in the JEDEC drawing.

† This dimension differs from the JEDEC drawing.

Drawings not to scale.

## APPENDIX A: REVISION HISTORY

### Revision A (June 2016)

- Converted Supertex Doc# DSFP-VN2210 to Microchip DS20005559A.
- Made minor text changes throughout the document.

## PRODUCT IDENTIFICATION SYSTEM

To order or obtain information, e.g., on pricing or delivery, contact your local Microchip representative or sales office.

<u>PART NO.</u>	<u>XX</u>	-	<u>X</u>	-	<u>X</u>
Device	Package Options		Environmental		Media Type
Device:	VN2210	=	N-Channel Enhancement-Mode Vertical DMOS FET		
Packages:	N2	=	3-lead TO-39		
	N3	=	3-lead TO-92		
Environmental:	G	=	Lead (Pb)-free/RoHS-compliant Package		
Media Type:	(blank)	=	500/Bag for N2 Package 1000/Bag for N3 Package		
<p>Note: VN2210N2 does not include a "-G" designator. However, the package is an RoHS-compliant product.</p>					

### Examples:

- a) VN2210N2: N-Channel Enhancement-Mode Vertical DMOS FET, 3-lead TO-39 Package, 500/Bag
- b) VN2210N3-G: N-Channel Enhancement-Mode Vertical DMOS FET, 3-lead TO-92 Package, 1000/Bag

---

---

**Note the following details of the code protection feature on Microchip devices:**

- Microchip products meet the specification contained in their particular Microchip Data Sheet.
- Microchip believes that its family of products is one of the most secure families of its kind on the market today, when used in the intended manner and under normal conditions.
- There are dishonest and possibly illegal methods used to breach the code protection feature. All of these methods, to our knowledge, require using the Microchip products in a manner outside the operating specifications contained in Microchip's Data Sheets. Most likely, the person doing so is engaged in theft of intellectual property.
- Microchip is willing to work with the customer who is concerned about the integrity of their code.
- Neither Microchip nor any other semiconductor manufacturer can guarantee the security of their code. Code protection does not mean that we are guaranteeing the product as “unbreakable.”

Code protection is constantly evolving. We at Microchip are committed to continuously improving the code protection features of our products. Attempts to break Microchip's code protection feature may be a violation of the Digital Millennium Copyright Act. If such acts allow unauthorized access to your software or other copyrighted work, you may have a right to sue for relief under that Act.

---

Information contained in this publication regarding device applications and the like is provided only for your convenience and may be superseded by updates. It is your responsibility to ensure that your application meets with your specifications. MICROCHIP MAKES NO REPRESENTATIONS OR WARRANTIES OF ANY KIND WHETHER EXPRESS OR IMPLIED, WRITTEN OR ORAL, STATUTORY OR OTHERWISE, RELATED TO THE INFORMATION, INCLUDING BUT NOT LIMITED TO ITS CONDITION, QUALITY, PERFORMANCE, MERCHANTABILITY OR FITNESS FOR PURPOSE. Microchip disclaims all liability arising from this information and its use. Use of Microchip devices in life support and/or safety applications is entirely at the buyer's risk, and the buyer agrees to defend, indemnify and hold harmless Microchip from any and all damages, claims, suits, or expenses resulting from such use. No licenses are conveyed, implicitly or otherwise, under any Microchip intellectual property rights unless otherwise stated.

*Microchip received ISO/TS-16949:2009 certification for its worldwide headquarters, design and wafer fabrication facilities in Chandler and Tempe, Arizona; Gresham, Oregon and design centers in California and India. The Company's quality system processes and procedures are for its PIC® MCUs and dsPIC® DSCs, KEELOQ® code hopping devices, Serial EEPROMs, microperipherals, nonvolatile memory and analog products. In addition, Microchip's quality system for the design and manufacture of development systems is ISO 9001:2000 certified.*

**QUALITY MANAGEMENT SYSTEM  
CERTIFIED BY DNV  
= ISO/TS 16949 =**

### Trademarks

The Microchip name and logo, the Microchip logo, AnyRate, dsPIC, FlashFlex, flexPWR, Heldo, JukeBlox, KeeLoq, KeeLoq logo, Klear, LANCheck, LINK MD, MediaLB, MOST, MOST logo, MPLAB, OptoLyzer, PIC, PICSTART, PIC32 logo, RightTouch, SpyNIC, SST, SST Logo, SuperFlash and UNI/O are registered trademarks of Microchip Technology Incorporated in the U.S.A. and other countries.

ClockWorks, The Embedded Control Solutions Company, ETHERSYNCH, Hyper Speed Control, HyperLight Load, IntelliMOS, mTouch, Precision Edge, and QUIET-WIRE are registered trademarks of Microchip Technology Incorporated in the U.S.A.

Analog-for-the-Digital Age, Any Capacitor, AnyIn, AnyOut, BodyCom, chipKIT, chipKIT logo, CodeGuard, dsPICDEM, dsPICDEM.net, Dynamic Average Matching, DAM, ECAN, EtherGREEN, In-Circuit Serial Programming, ICSP, Inter-Chip Connectivity, JitterBlocker, KlearNet, KlearNet logo, MiWi, motorBench, MPASM, MPF, MPLAB Certified logo, MPLIB, MPLINK, MultiTRAK, NetDetach, Omniscient Code Generation, PICDEM, PICDEM.net, PICkit, PICtail, PureSilicon, RightTouch logo, REAL ICE, Ripple Blocker, Serial Quad I/O, SQL, SuperSwitcher, SuperSwitcher II, Total Endurance, TSHARC, USBCheck, VariSense, ViewSpan, WiperLock, Wireless DNA, and ZENA are trademarks of Microchip Technology Incorporated in the U.S.A. and other countries.

SQTP is a service mark of Microchip Technology Incorporated in the U.S.A.

Silicon Storage Technology is a registered trademark of Microchip Technology Inc. in other countries.

GestIC is a registered trademarks of Microchip Technology Germany II GmbH & Co. KG, a subsidiary of Microchip Technology Inc., in other countries.

All other trademarks mentioned herein are property of their respective companies.

© 2016, Microchip Technology Incorporated, Printed in the U.S.A., All Rights Reserved.

ISBN: 978-1-5224-0686-0



# MICROCHIP

## Worldwide Sales and Service

### AMERICAS

#### Corporate Office

2355 West Chandler Blvd.  
Chandler, AZ 85224-6199

Tel: 480-792-7200

Fax: 480-792-7277

Technical Support:

[http://www.microchip.com/  
support](http://www.microchip.com/support)

Web Address:

[www.microchip.com](http://www.microchip.com)

#### Atlanta

Duluth, GA

Tel: 678-957-9614

Fax: 678-957-1455

#### Austin, TX

Tel: 512-257-3370

#### Boston

Westborough, MA

Tel: 774-760-0087

Fax: 774-760-0088

#### Chicago

Itasca, IL

Tel: 630-285-0071

Fax: 630-285-0075

#### Cleveland

Independence, OH

Tel: 216-447-0464

Fax: 216-447-0643

#### Dallas

Addison, TX

Tel: 972-818-7423

Fax: 972-818-2924

#### Detroit

Novi, MI

Tel: 248-848-4000

#### Houston, TX

Tel: 281-894-5983

#### Indianapolis

Noblesville, IN

Tel: 317-773-8323

Fax: 317-773-5453

#### Los Angeles

Mission Viejo, CA

Tel: 949-462-9523

Fax: 949-462-9608

#### New York, NY

Tel: 631-435-6000

#### San Jose, CA

Tel: 408-735-9110

#### Canada - Toronto

Tel: 905-673-0699

Fax: 905-673-6509

### ASIA/PACIFIC

#### Asia Pacific Office

Suites 3707-14, 37th Floor  
Tower 6, The Gateway  
Harbour City, Kowloon

#### Hong Kong

Tel: 852-2943-5100

Fax: 852-2401-3431

#### Australia - Sydney

Tel: 61-2-9868-6733

Fax: 61-2-9868-6755

#### China - Beijing

Tel: 86-10-8569-7000

Fax: 86-10-8528-2104

#### China - Chengdu

Tel: 86-28-8665-5511

Fax: 86-28-8665-7889

#### China - Chongqing

Tel: 86-23-8980-9588

Fax: 86-23-8980-9500

#### China - Dongguan

Tel: 86-769-8702-9880

#### China - Hangzhou

Tel: 86-571-8792-8115

Fax: 86-571-8792-8116

#### China - Hong Kong SAR

Tel: 852-2943-5100

Fax: 852-2401-3431

#### China - Nanjing

Tel: 86-25-8473-2460

Fax: 86-25-8473-2470

#### China - Qingdao

Tel: 86-532-8502-7355

Fax: 86-532-8502-7205

#### China - Shanghai

Tel: 86-21-5407-5533

Fax: 86-21-5407-5066

#### China - Shenyang

Tel: 86-24-2334-2829

Fax: 86-24-2334-2393

#### China - Shenzhen

Tel: 86-755-8864-2200

Fax: 86-755-8203-1760

#### China - Wuhan

Tel: 86-27-5980-5300

Fax: 86-27-5980-5118

#### China - Xian

Tel: 86-29-8833-7252

Fax: 86-29-8833-7256

### ASIA/PACIFIC

#### China - Xiamen

Tel: 86-592-2388138

Fax: 86-592-2388130

#### China - Zhuhai

Tel: 86-756-3210040

Fax: 86-756-3210049

#### India - Bangalore

Tel: 91-80-3090-4444

Fax: 91-80-3090-4123

#### India - New Delhi

Tel: 91-11-4160-8631

Fax: 91-11-4160-8632

#### India - Pune

Tel: 91-20-3019-1500

#### Japan - Osaka

Tel: 81-6-6152-7160

Fax: 81-6-6152-9310

#### Japan - Tokyo

Tel: 81-3-6880-3770

Fax: 81-3-6880-3771

#### Korea - Daegu

Tel: 82-53-744-4301

Fax: 82-53-744-4302

#### Korea - Seoul

Tel: 82-2-554-7200

Fax: 82-2-558-5932 or

82-2-558-5934

#### Malaysia - Kuala Lumpur

Tel: 60-3-6201-9857

Fax: 60-3-6201-9859

#### Malaysia - Penang

Tel: 60-4-227-8870

Fax: 60-4-227-4068

#### Philippines - Manila

Tel: 63-2-634-9065

Fax: 63-2-634-9069

#### Singapore

Tel: 65-6334-8870

Fax: 65-6334-8850

#### Taiwan - Hsin Chu

Tel: 886-3-5778-366

Fax: 886-3-5770-955

#### Taiwan - Kaohsiung

Tel: 886-7-213-7828

#### Taiwan - Taipei

Tel: 886-2-2508-8600

Fax: 886-2-2508-0102

#### Thailand - Bangkok

Tel: 66-2-694-1351

Fax: 66-2-694-1350

### EUROPE

#### Austria - Wels

Tel: 43-7242-2244-39

Fax: 43-7242-2244-393

#### Denmark - Copenhagen

Tel: 45-4450-2828

Fax: 45-4485-2829

#### France - Paris

Tel: 33-1-69-53-63-20

Fax: 33-1-69-30-90-79

#### Germany - Dusseldorf

Tel: 49-2129-3766400

#### Germany - Karlsruhe

Tel: 49-721-625370

#### Germany - Munich

Tel: 49-89-627-144-0

Fax: 49-89-627-144-44

#### Italy - Milan

Tel: 39-0331-742611

Fax: 39-0331-466781

#### Italy - Venice

Tel: 39-049-7625286

#### Netherlands - Drunen

Tel: 31-416-690399

Fax: 31-416-690340

#### Poland - Warsaw

Tel: 48-22-3325737

#### Spain - Madrid

Tel: 34-91-708-08-90

Fax: 34-91-708-08-91

#### Sweden - Stockholm

Tel: 46-8-5090-4654

#### UK - Wokingham

Tel: 44-118-921-5800

Fax: 44-118-921-5820

07/14/15