

DRAFT SPECIFICATION

PATENT PENDING

- Part No. : **MA930.W.A.LBICGJ.005**
- Product Name : Guardian 6in1 Adhesive and Wall Mount Antenna
LTE*2+Wi-Fi*2+GNSS+Satellite L Band Antenna
- Features : Low-profile Housing – Mounts flush to Wall
2* LTE MIMO 698-960MHz / 1710-2170MHz / 2490-2690MHz / 3300-3600MHz
2* Wi-Fi MIMO 2.4GHz/5.8GHz
1* GPS-GLONASS-GALILEO-BeiDou Antenna
1* Satellite L Band Antenna
Worldwide 4G Bands including fallback to 3G & 2G
IP67 Waterproof ASA Enclosure
Dims: 146*134*20mm
1M Low Loss KSR200-P and RG174 Cables with SMA(M)/RP-SMA(M) connectors
Cables and Connectors Customizable

RoHS Compliant

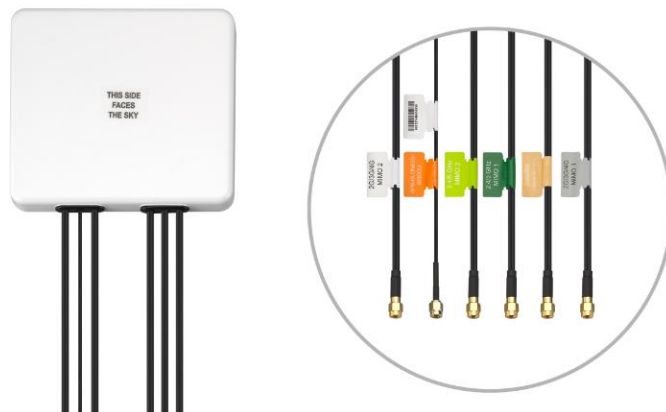

1. Introduction

The MA930 Guardian is a next generation combination antenna. It is the first panel antenna worldwide designed for IoT Gateway and Router devices with multiple wireless technologies. It is a low profile 6in1 wall and adhesive mount antenna. It is a heavy-duty, fully IP67 waterproof external M2M antenna for use by RF professionals in

IoT Gateway and Routers

HD Video Streaming

Transportation

Remote Monitoring Applications.

This antenna delivers powerful MIMO antenna technology for worldwide 4G LTE bands at 698-960MHz / 1710-2170MHz / 2490-2690MHz / 3300-3600MHz, Satellite L band, dual-band 2.4/5.8GHz Wi-Fi, plus GPS-GLONASS-GALILEO-BEIDOU for location accuracy. It enables designers to cover a wide range of technologies by installing a single antenna.

4G wireless applications demand high speed data uplink and downlink. High efficiency and high gain MIMO antennas are necessary to achieve the required signal to noise ratio and throughput required to solve these challenges. Taoglas also takes care to have high isolation among these antennas to prevent self-interference. Low loss cables used to keep efficiency high over long cable lengths.

The GPS-GLONASS-GALILEO-BEIDOU active antenna has been carefully designed for excellent performance across all L1 GNSS bands, leading to higher location accuracy and stability of tracking in urban environments.

The housing is IP67 waterproof and comes with a 3M adhesive. The antenna can be mounted internally or externally on a vehicle. The MA931 comes with 1 meter, low loss KSR-200P coaxial cables for the LTE and Wi-Fi antennas, and RG174 coaxial cable for the GNSS antenna as standard. Customized cables and connector versions are also available.

2. Specification

GPS-GLONASS-GALILEO-BeiDou				
Center Frequency	GPS/GALILEO:1575.42±1.023MHz GLONASS:1602±5MHz BeiDou:1561.098±2.046MHz			
Passive Antenna Efficiency (without cable loss)	GPS/GALILEO: 48% GLONASS: 57% BeiDou: 63%			
Passive Antenna Average Gain (without cable loss)	GPS/GALILEO: -3.13dBi GLONASS: -2.39dBi BeiDou: -1.97dBi			
Passive Antenna Peak Gain (without cable loss)	GPS/GALILEO: 1.98dBi GLONASS: 3.01dBi BeiDou: 3dBi			
VSWR	3:1 Max			
Impedance	50Ω			
Axial Ratio	GPS/GALILEO:<14.02 GLONASS:<5.9 BeiDou:<9.7			
Polarization	RHCP			
Cable	1 meter RG174 standard, fully customizable			
Connector	SMA(M) standard, fully customizable			
LNA and Filter Electrical Properties				
Center Frequency	GPS/GALILEO:1575.42±1.023MHz GLONASS:1602±5MHz BeiDou: 1561.098±2.046MHz			
Output Impedance	50Ω			
VSWR	< 2:1			
Return Loss	10dB Min.			
LNA Gain, Current Draw, and Noise Figure@GPS	Voltage	LNA Gain(Typ)	Current Draw(mA) Typ	Noise Figure(Typ)
	Min 1.8V	28dB	7.9mA	1.13dB
	Typ 3.0V	30dB	9.0mA	1.13dB
	Max 5.5V	33dB	9.9mA	1.14dB
Total Specification (Through Antenna, SAW Filter, and LNA)				
Frequency	1561.098±2.046MHz	1575.42±1.023MHz	1602±5MHz	
Gain@3V	1561MHz:28±3dBi	1575.42MHz:28±3dBi	1602MHz:28±3dBi	
Output Impedance	50Ω			

4G/3G/2G LTE Antenna

Frequency (MHz)		LTE700	GSM850	GSM900	DCS	PCS	UMTS1	LTE2600	LTE3500
		698~803	824~894	880~960	1710~1880	1850~1990	1920~2170	2490~2690	3300~3600
Efficiency (%)									
MIMO_1	Free space	50.82	55.85	41.29	66.47	70.19	71.51	49.20	50.92
	ABS	68.31	69.61	61.27	66.31	70.86	70.00	50.61	51.88
	Glass	67.99	67.37	62.94	66.89	71.80	69.58	51.00	52.83
	Metal	42.12	51.55	58.33	39.49	47.20	47.71	44.36	44.85
	Wall	67.97	70.42	66.80	63.91	64.94	63.35	50.37	51.49
MIMO_2	Free space	54.13	58.97	48.65	61.54	68.31	68.39	54.62	52.55
	ABS	71.74	66.05	58.58	63.18	69.29	69.23	53.95	54.95
	Glass	64.53	55.70	45.22	64.94	67.87	65.86	50.05	51.77
	Metal	55.62	63.13	56.59	32.14	40.89	43.97	54.22	52.90
	Wall	61.91	48.38	52.88	58.00	56.47	56.36	54.68	48.72
Average Gain (dBi)									
MIMO_1	Free space	-2.96	-2.62	-3.85	-1.78	-1.54	-1.46	-3.12	-2.96
	ABS	-1.68	-1.59	-2.13	-1.79	-1.50	-1.55	-3.00	-2.87
	Glass	-1.73	-1.73	-2.02	-1.75	-1.44	-1.58	-2.96	-2.79
	Metal	-3.94	-2.88	-2.37	-4.07	-3.27	-3.23	-3.57	-3.51
	Wall	-1.70	-1.53	-1.76	-1.95	-1.88	-1.99	-3.00	-2.89
MIMO_2	Free space	-2.72	-2.32	-3.17	-2.11	-1.66	-1.66	-2.65	-2.83
	ABS	-1.47	-1.81	-2.33	-2.00	-1.59	-1.60	-2.71	-2.63
	Glass	-1.93	-2.56	-3.46	-1.88	-1.68	-1.82	-3.04	-2.87
	Metal	-2.61	-2.00	-2.50	-4.95	-3.90	-3.59	-2.67	-2.77
	Wall	-2.09	-3.15	-2.79	-2.37	-2.48	-2.50	-2.63	-3.15
Peak Gain (dBi)									
MIMO_1	Free space	3.18	3.60	2.14	3.98	4.37	4.37	3.70	4.49
	ABS	4.65	4.00	3.45	5.24	6.05	6.05	4.69	3.18
	Glass	3.71	3.92	4.35	5.28	6.16	7.67	5.34	3.87
	Metal	5.09	3.10	4.73	4.50	4.96	5.69	6.02	4.96
	Wall	4.74	4.97	3.67	5.44	4.84	4.84	5.08	3.75
MIMO_2	Free space	5.83	3.66	2.57	3.78	4.01	4.01	3.87	3.97
	ABS	4.33	4.52	4.41	4.34	4.73	5.69	5.64	5.42
	Glass	3.02	3.14	1.36	4.99	5.89	6.02	6.18	4.42
	Metal	3.54	3.11	3.33	3.12	4.36	5.02	7.16	4.95
	Wall	3.21	1.77	2.15	5.49	5.49	7.20	6.10	4.74
Impedance				50Ω					
Polarization				Linear					
VSWR				< 3					
Cable				1 meter KSR200-P standard, fully customizable					
Connector				SMA(M) standard, fully customizable					

2.4GHz/5.8GHz Wi-Fi Antenna			
Frequency (MHz)		2400~2500	4900~5850
Efficiency (%)			
MIMO_1	Free space	57.73	48.06
	ABS	53.59	49.42
	Glass	53.98	47.16
	Metal	51.80	46.70
	Wall	61.02	46.29
MIMO_2	Free space	44.09	47.04
	ABS	46.34	46.79
	Glass	40.79	46.88
	Metal	45.58	45.59
	Wall	50.62	43.60
Average Gain (dBi)			
MIMO_1	Free space	-2.39	-3.25
	ABS	-2.71	-3.13
	Glass	-2.68	-3.36
	Metal	-2.86	-3.44
	Wall	-2.15	-3.42
MIMO_2	Free space	-3.57	-3.33
	ABS	-3.37	-3.36
	Glass	-3.91	-3.35
	Metal	-3.45	-3.52
	Wall	-2.96	-3.67
Peak Gain (dBi)			
MIMO_1	Free space	4.35	4.84
	ABS	5.34	5.18
	Glass	2.99	5.03
	Metal	5.22	5.98
	Wall	5.47	5.77
MIMO_2	Free space	2.94	5.70
	ABS	2.18	5.43
	Glass	3.75	7.07
	Metal	6.02	6.76
	Wall	3.23	5.97
Impedance	50Ω		
Polarization	Linear		
VSWR	< 3		
Cable	1 meter KSR200-P standard, fully customizable		
Connector	RP-SMA(M) standard, fully customizable		

SATELLITE L BAND 1621MHZ	
Center Frequency	1621±5 MHz
VSWR	< 2
Axial Ratio	3.6
Polarization	RHCP
Average Gain	-1.76dBi
Peak Gain	2.17dBi
Antenna Efficiency	66.67%
Cable	1 meter KSR200-P standard, fully customizable
Connector	SMA(M) standard, fully customizable

MECHANICAL	
Antenna Dimensions	146*134*20mm
Casing	ASA
Weight (including cable)	438g
Ingress Protection Rating	IP67
ENVIRONMENTAL	
Operation Temperature	-40°C to 85°C
Storage Temperature	-40°C to 90°C
Humidity	Non-condensing 65°C 95% RH

3. Antenna Characteristics

3.1 GPS-GLONASS-GALILEO-BeiDou

3.1.1 Block Diagram (Active antenna)

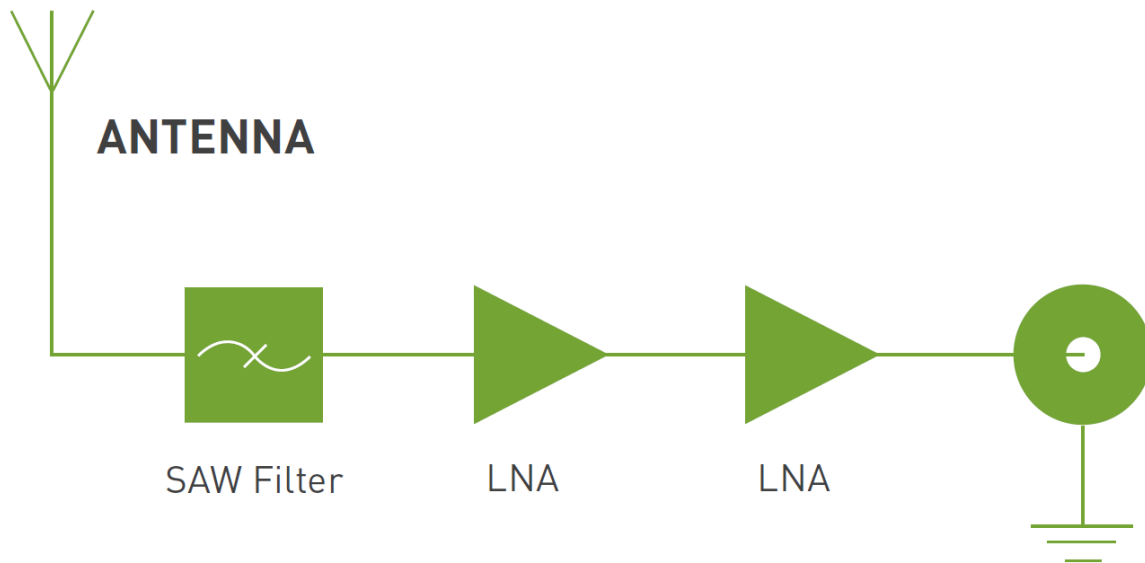

3.1.2 Test Setup



3.1.3 GPS-GLONASS-GALILEO-BeiDou Return Loss (Passive antenna)

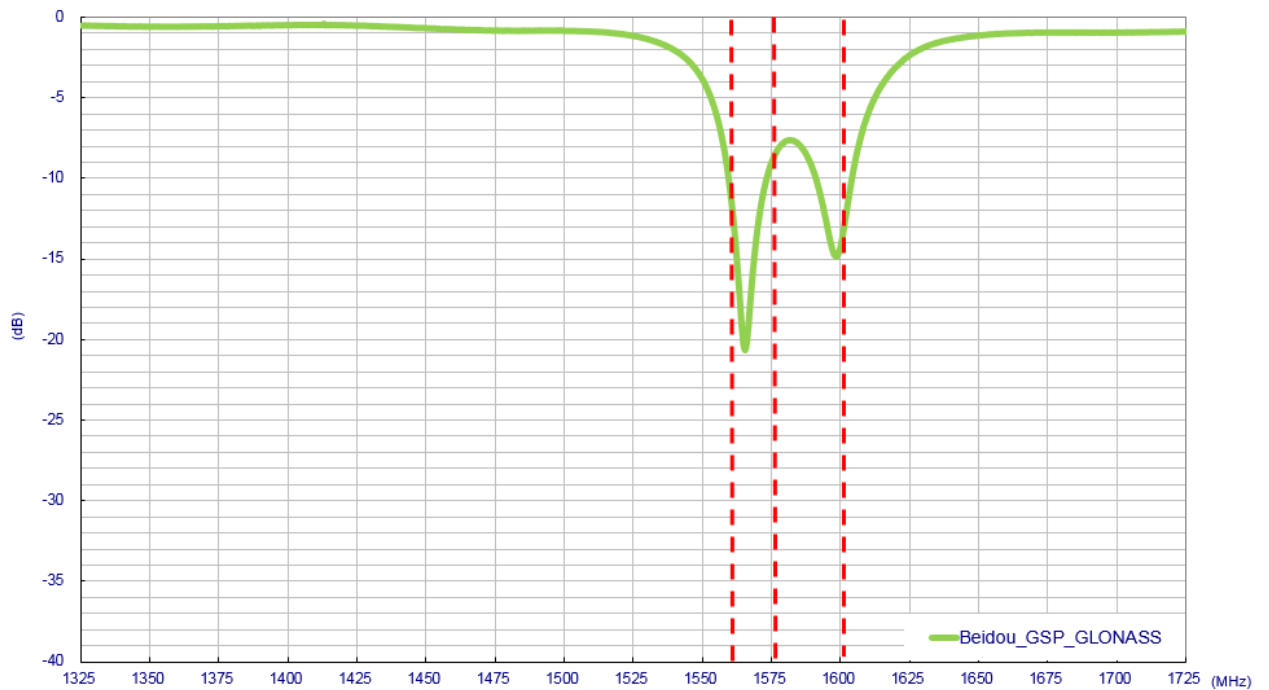

3.1.4 GPS-GLONASS-GALILEO-BeiDou Smith Chart (Passive antenna)

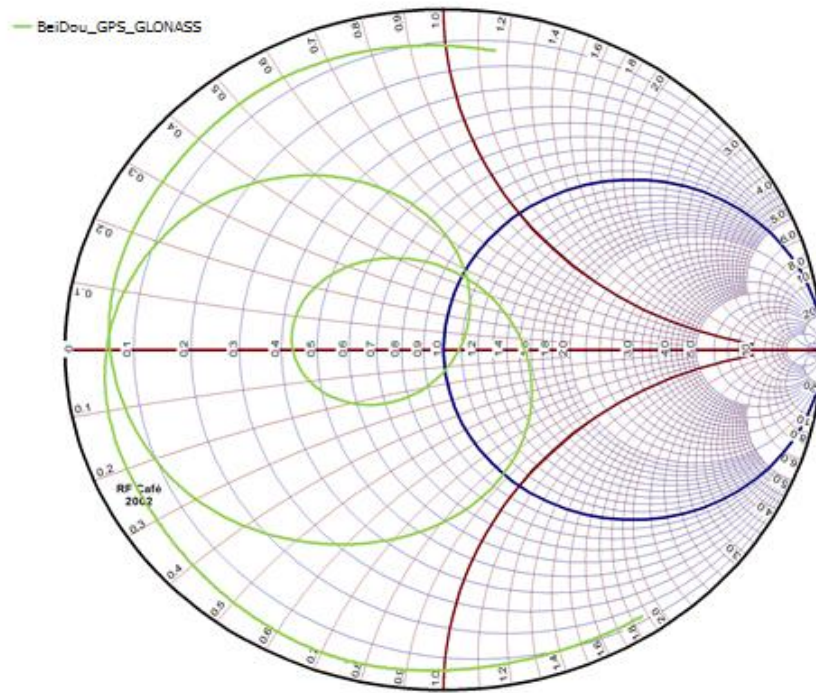

3.1.5 GPS-GLONASS-GALILEO-BeiDou Efficiency (Passive antenna)

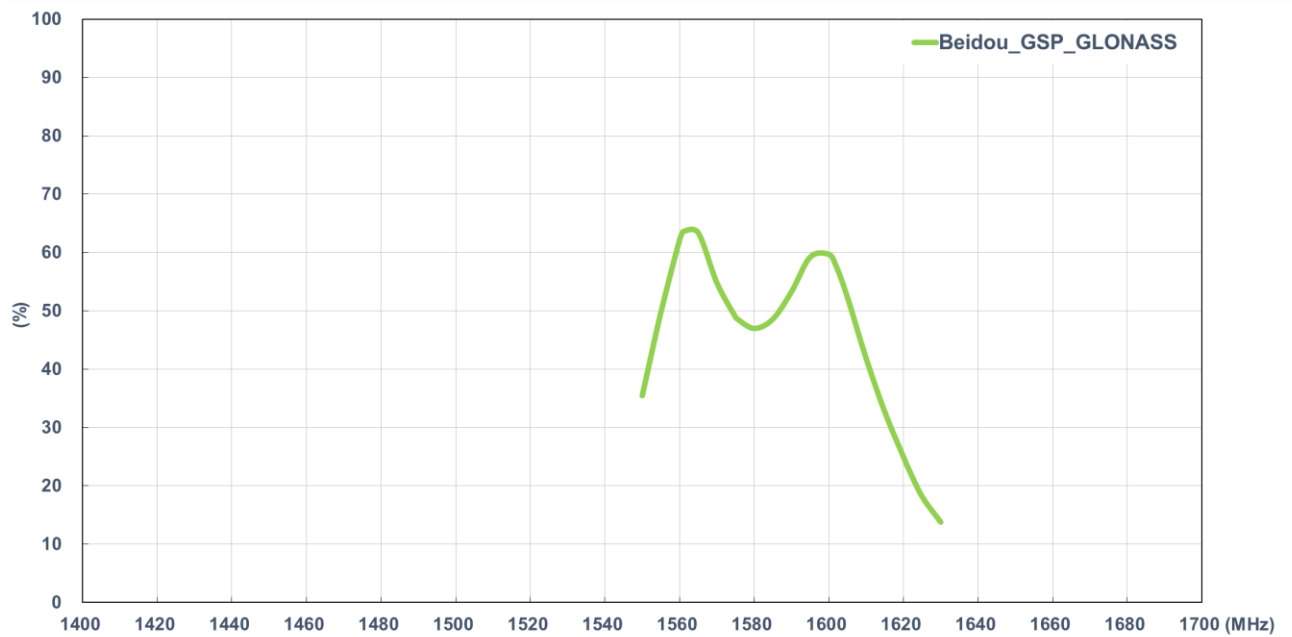

3.1.6 GPS-GLONASS-GALILEO-BeiDou Peak Gain (Passive antenna)

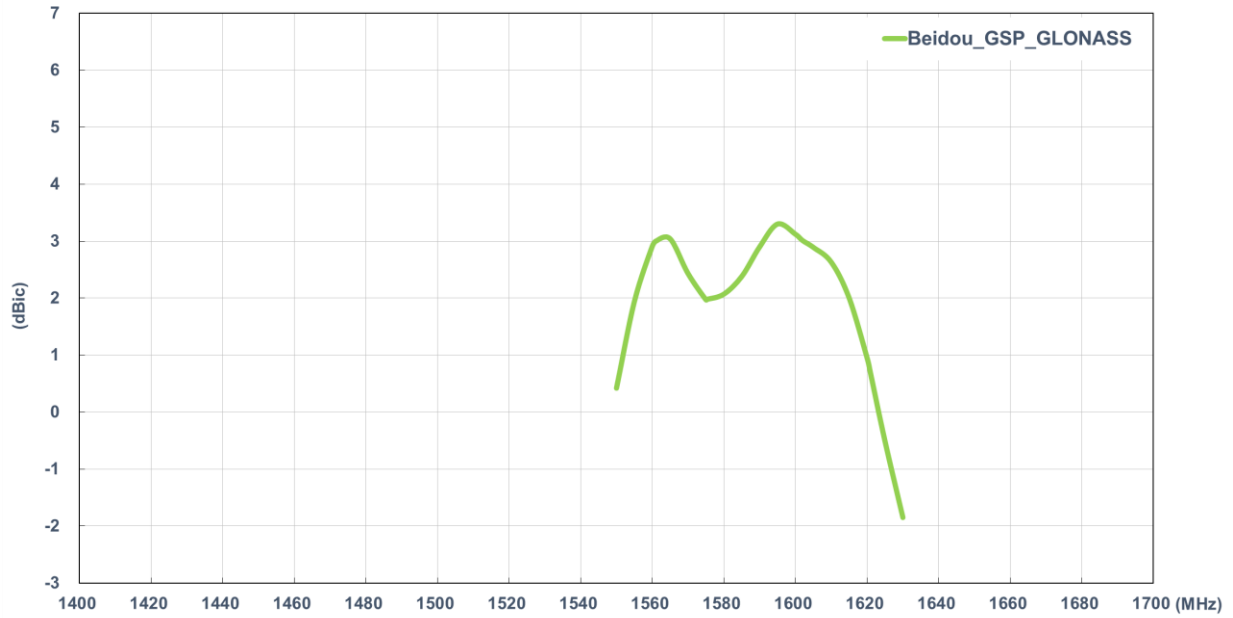

3.1.7 GPS-GLONASS-GALILEO-BeiDou Average Gain (Passive antenna)

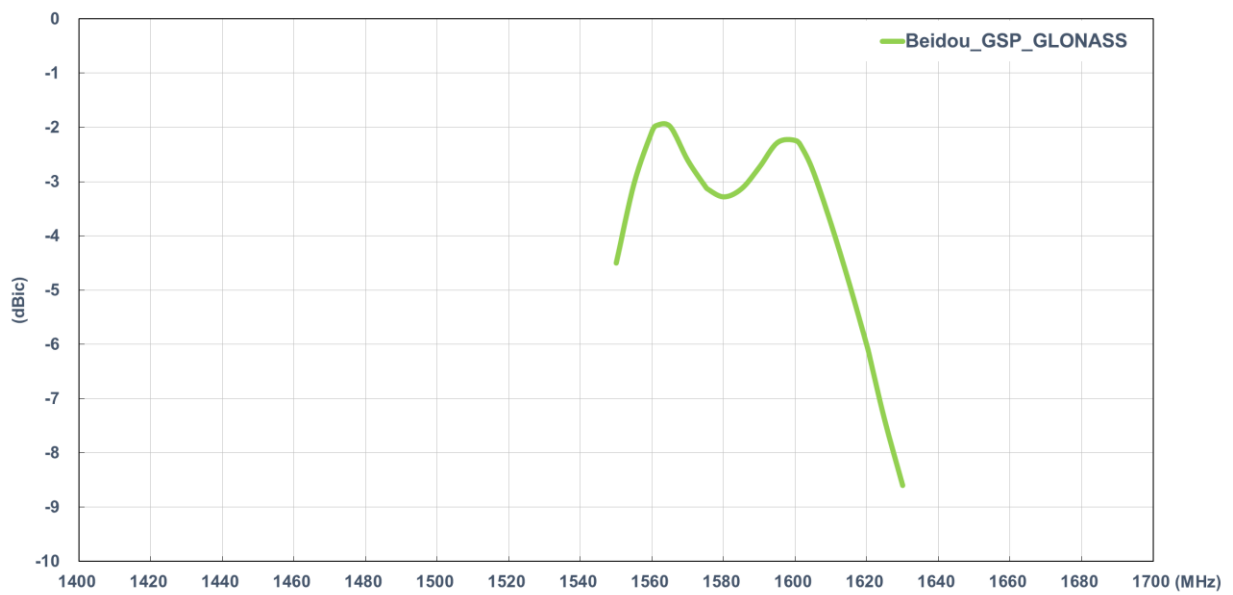

3.1.8 GPS-GLONASS-GALILEO-BeiDou Radiation Pattern (Passive antenna) 2D Radiation Pattern

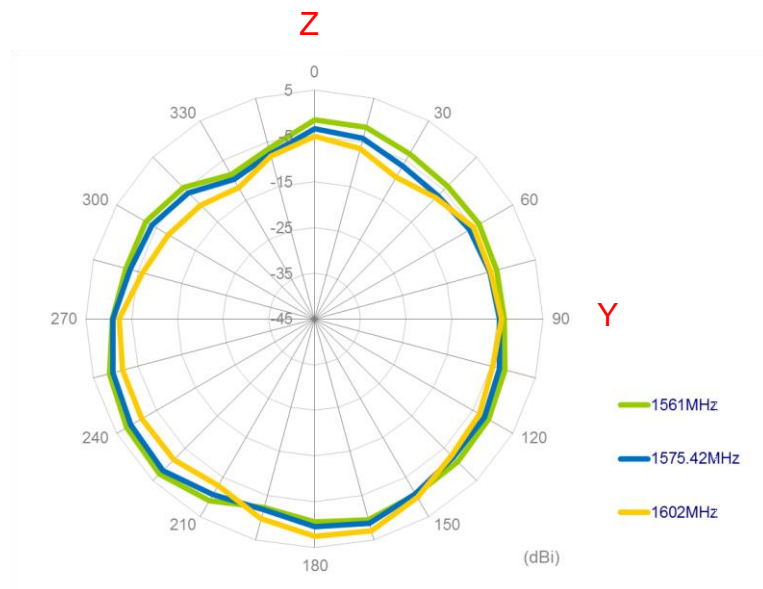
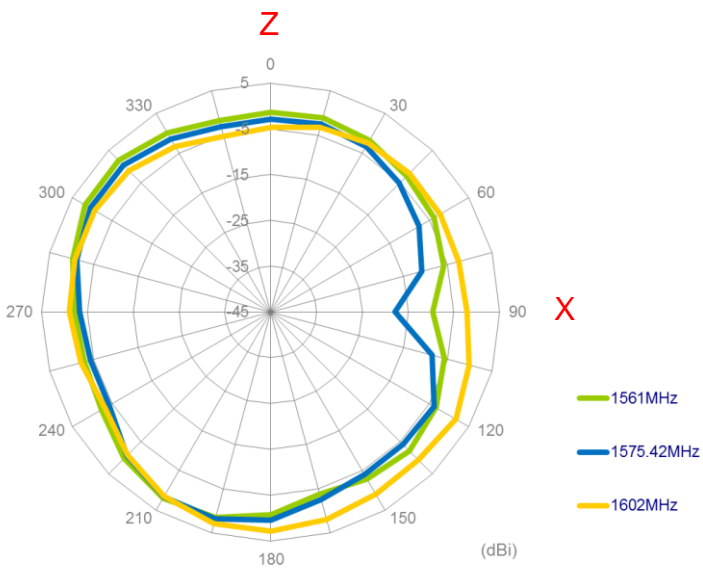
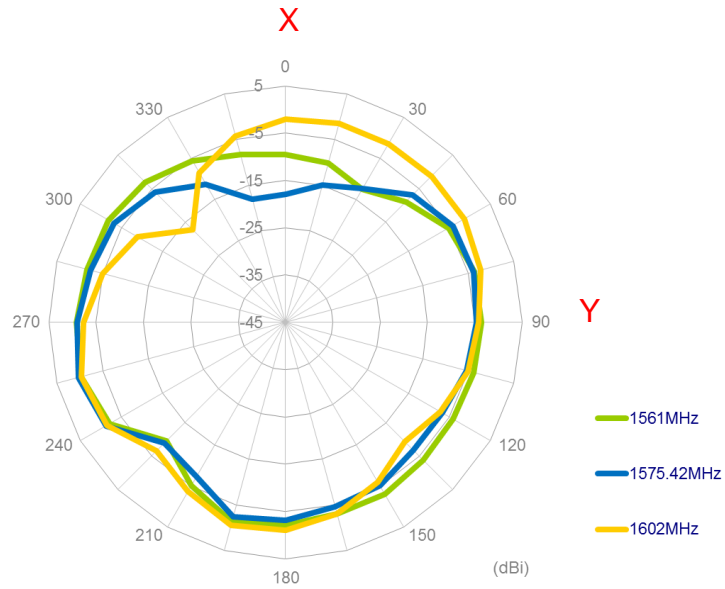

3D Radiation Pattern (Passive antenna)

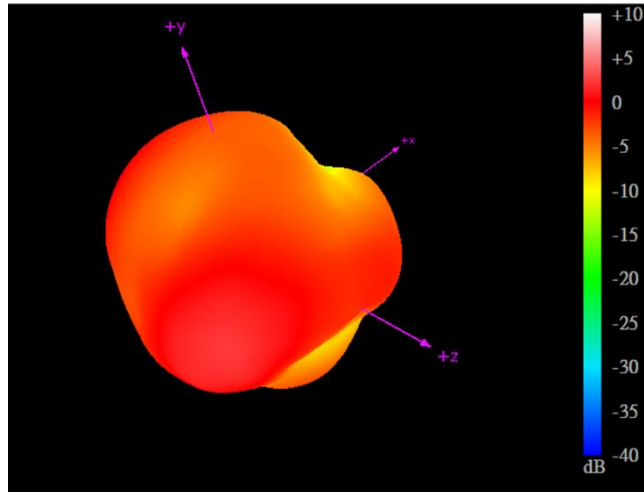

1561MHz

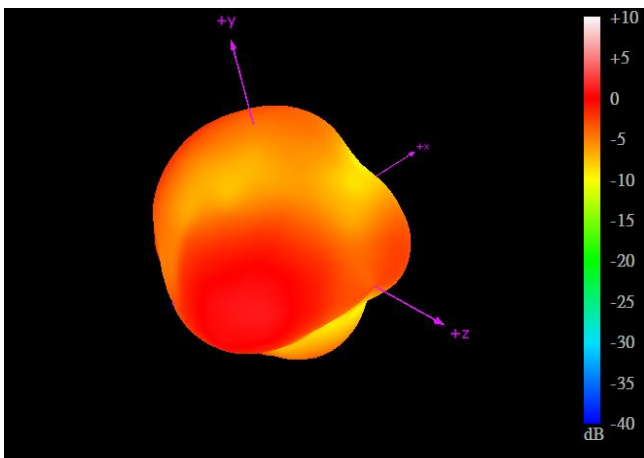

1575.42MHz

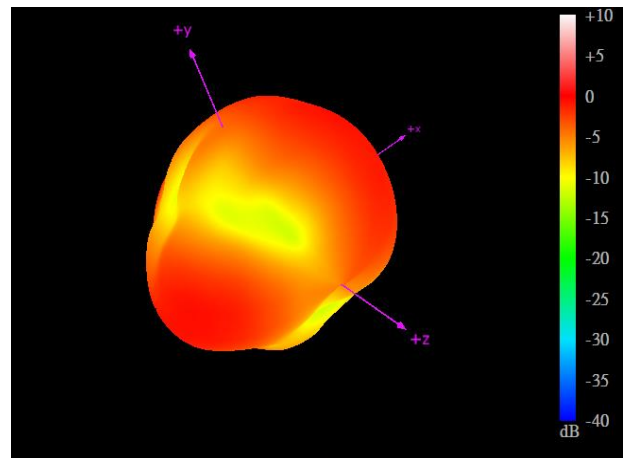

1602MHz

3.1.9 Axial Ratio (Passive antenna)

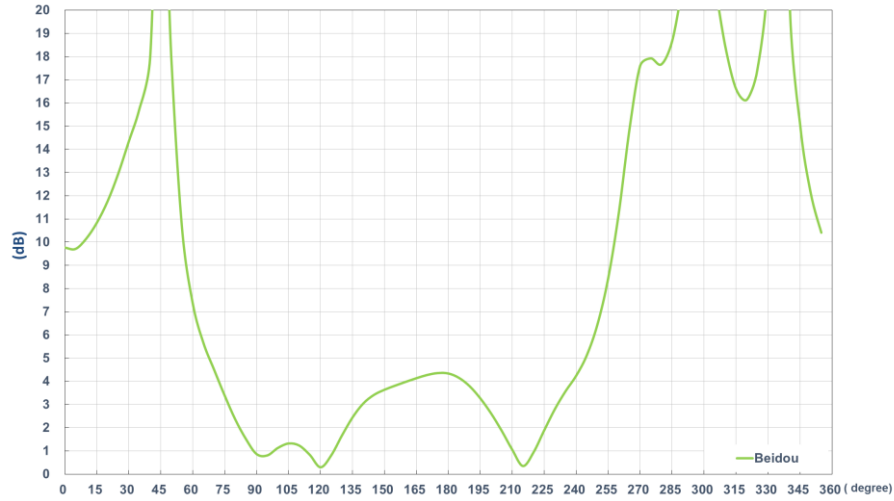

1561MHz

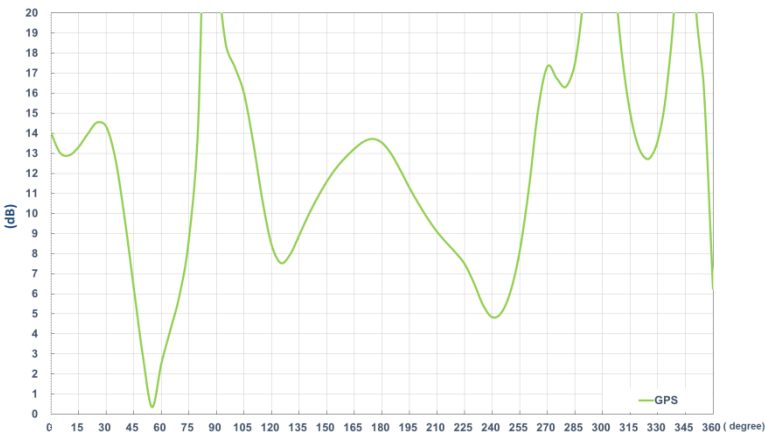

1575.42MHz

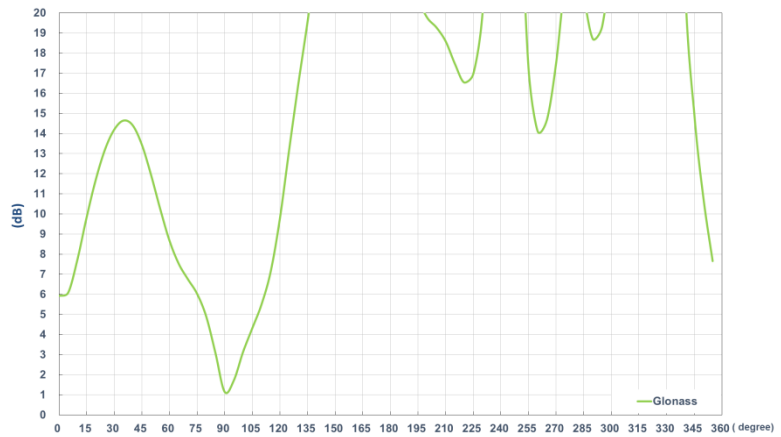

1602MHz

3.1.10 GPS-GLONASS-GALILEO-BeiDou LNA Gain and Noise Figure (Active antenna)

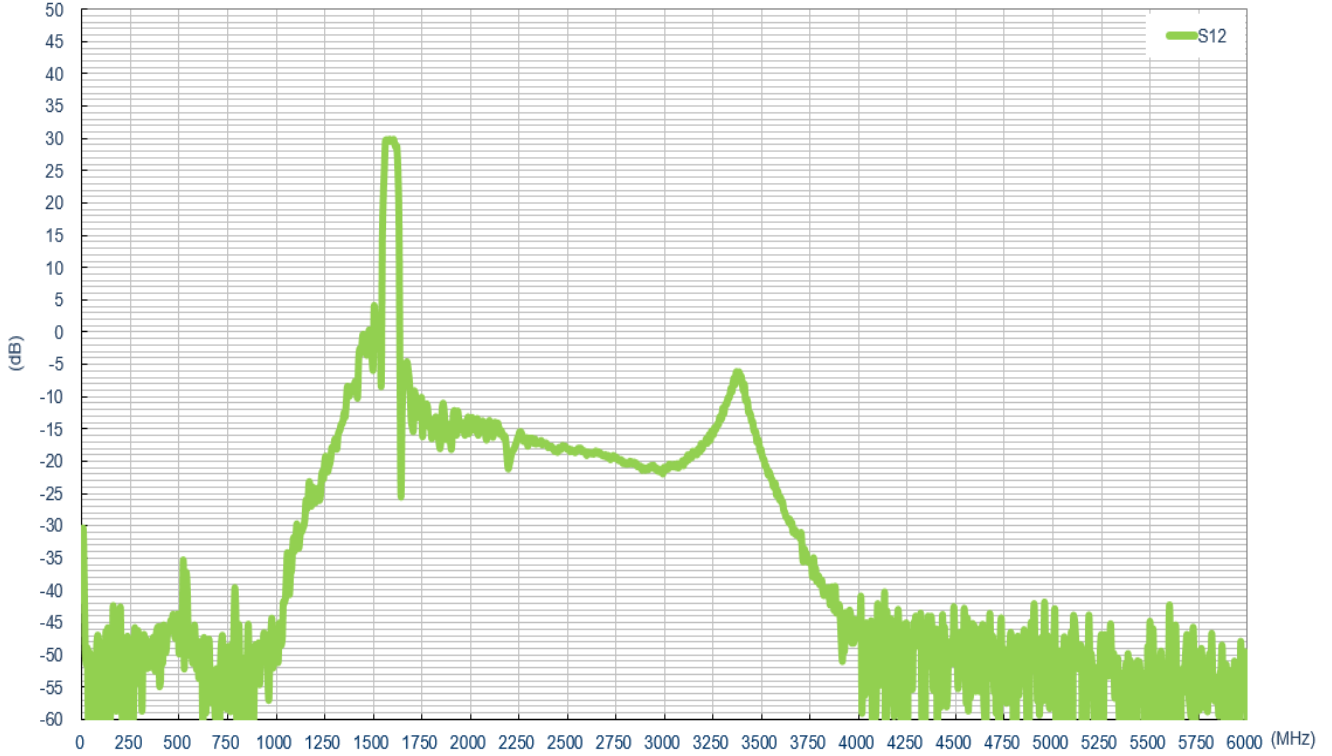

LNA Gain@3.0V

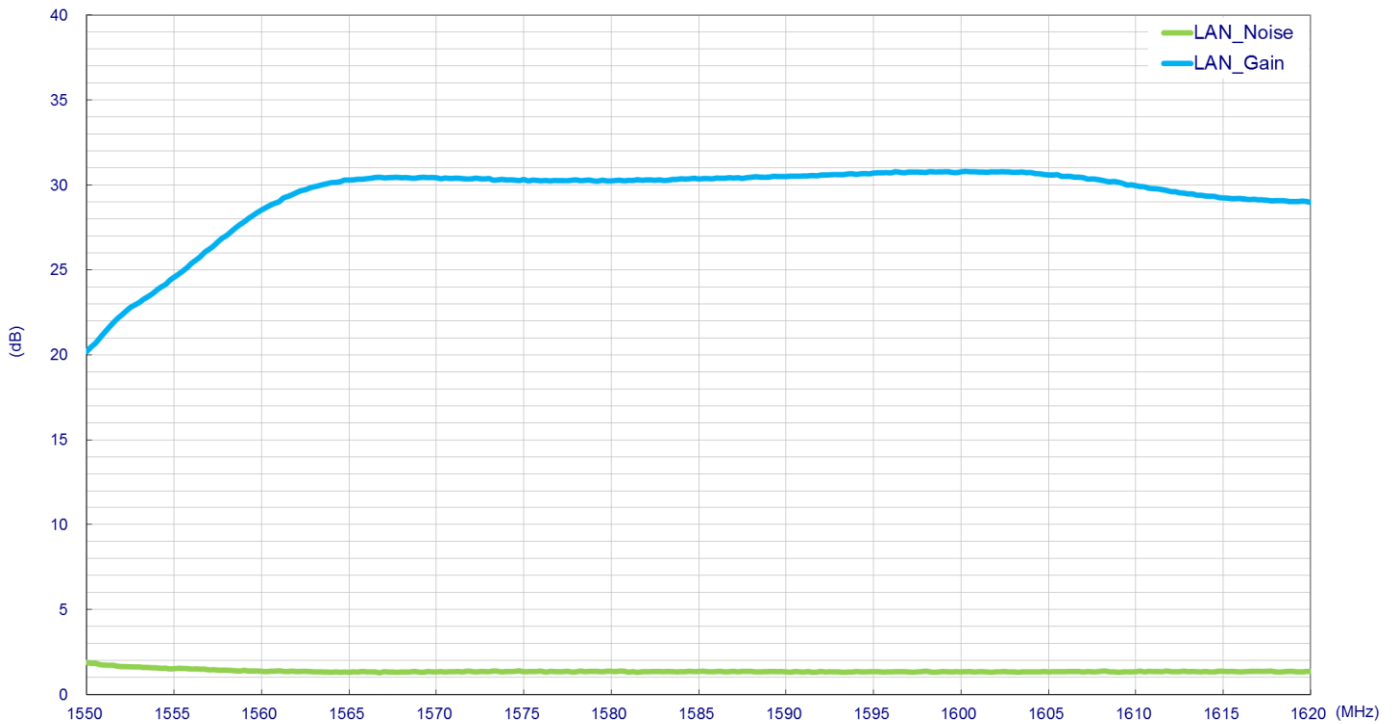

LNA Noise Figure @3.0V

3.2 Satellite L Band 1621MHz Antenna

3.2.1 Test Setup



3.2.2 Satellite L Band Return Loss

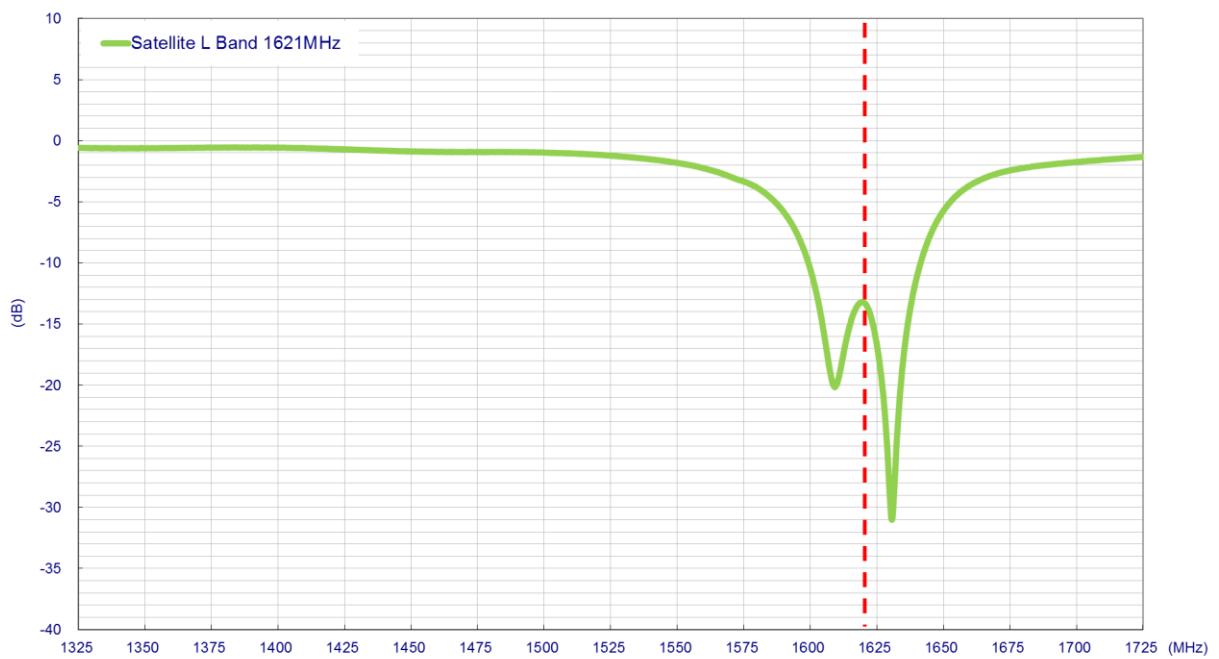

3.2.3 Satellite L Band Smith Chart

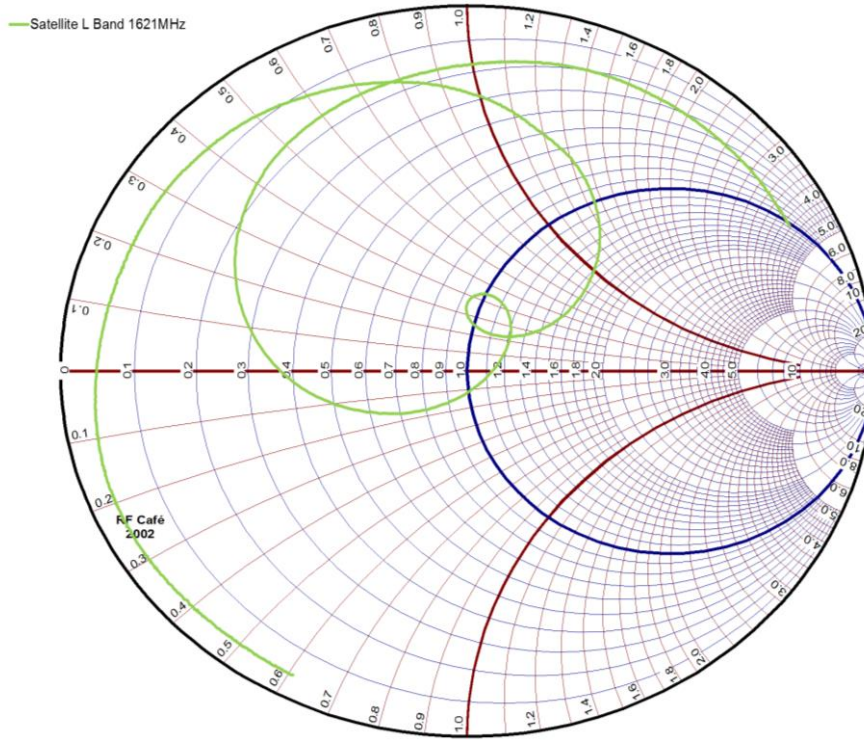

3.2.4 Satellite L Band Efficiency

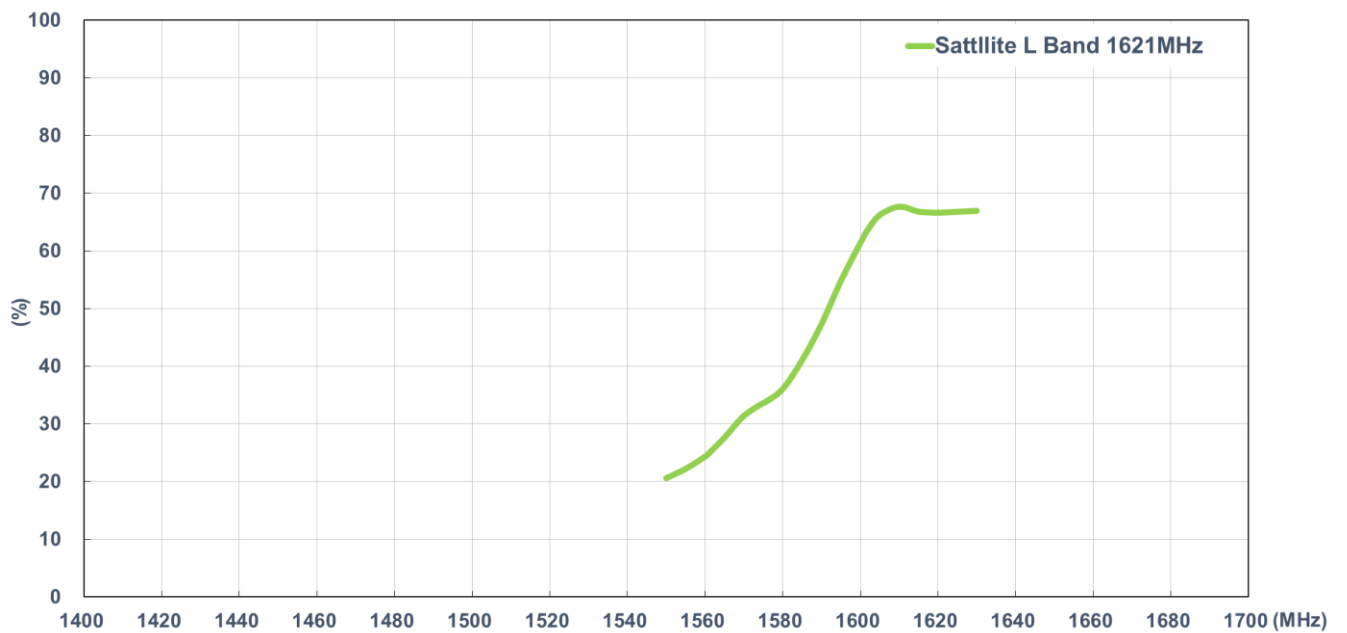

3.2.5 Satellite L Band Peak Gain

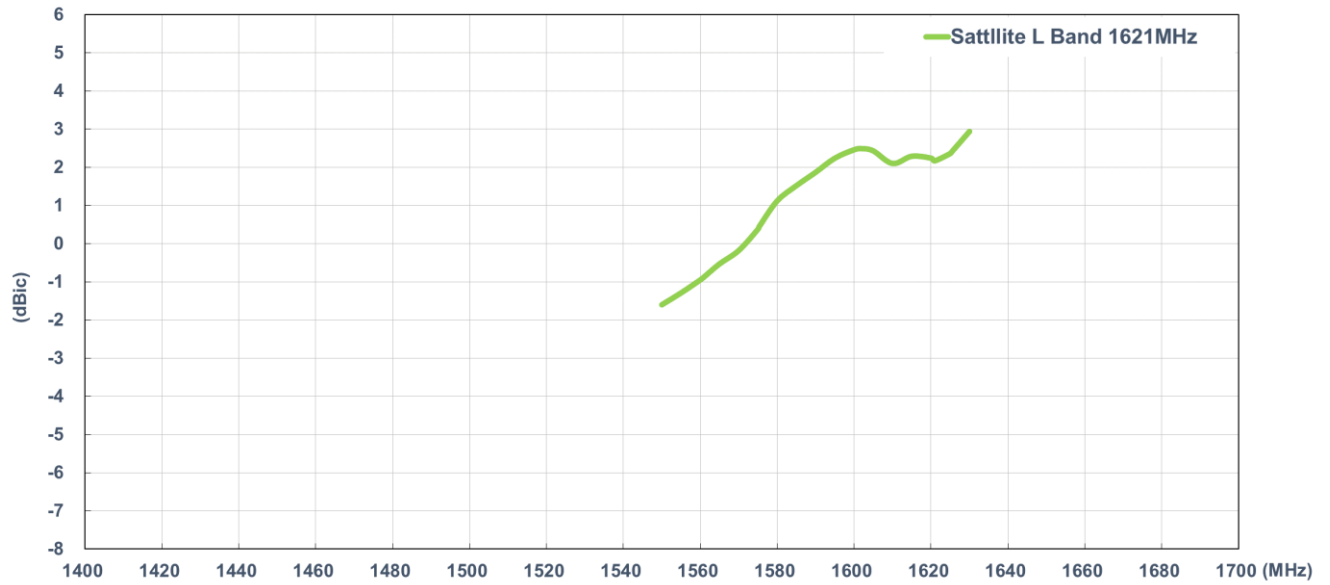

3.2.6 Satellite L Band Average Gain

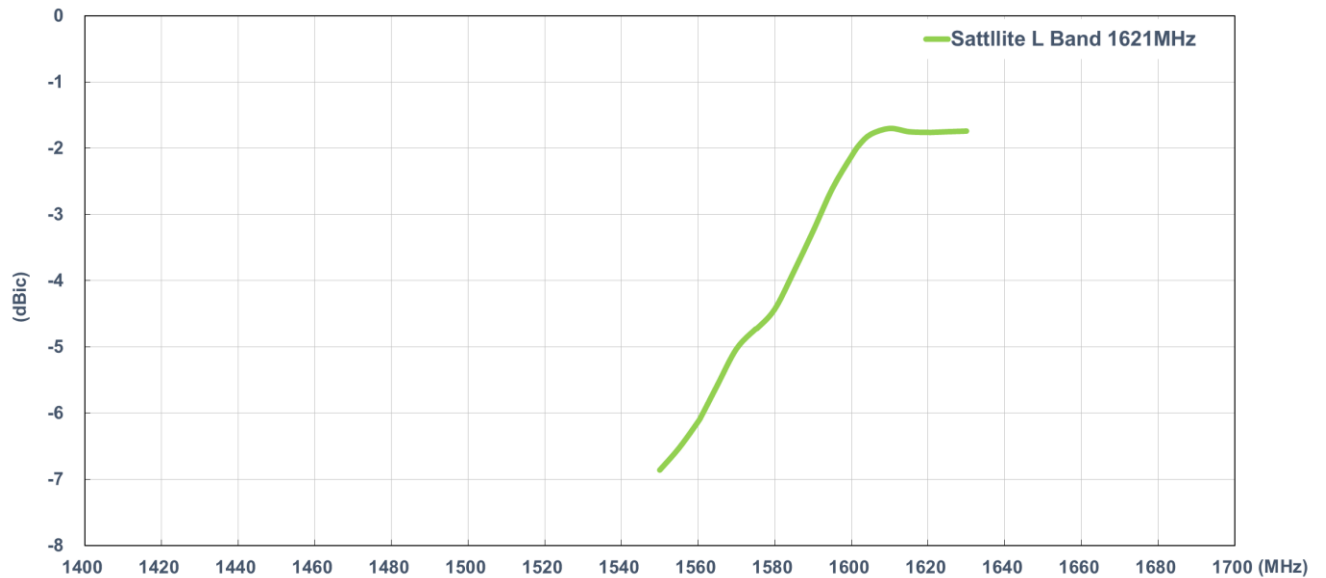

3.2.7 Satellite L Band Radiation Pattern 2D Radiation Pattern

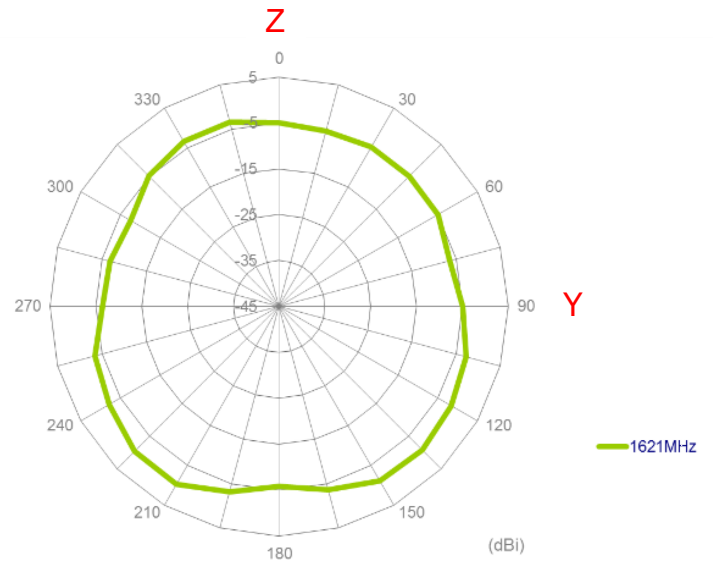
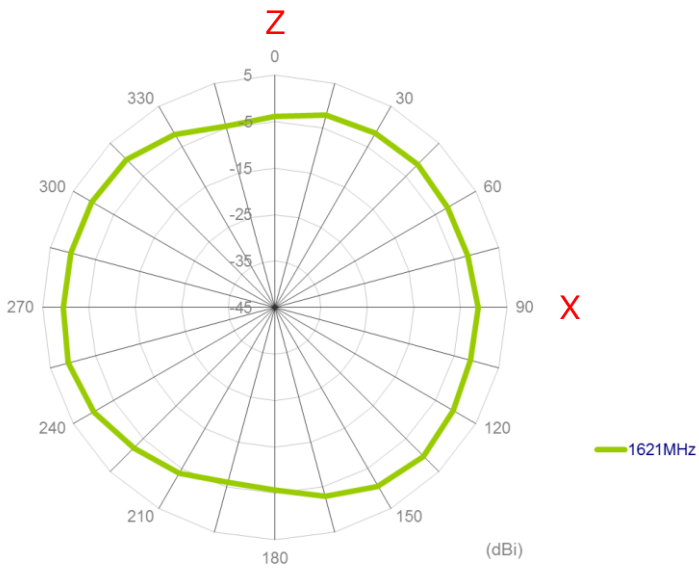
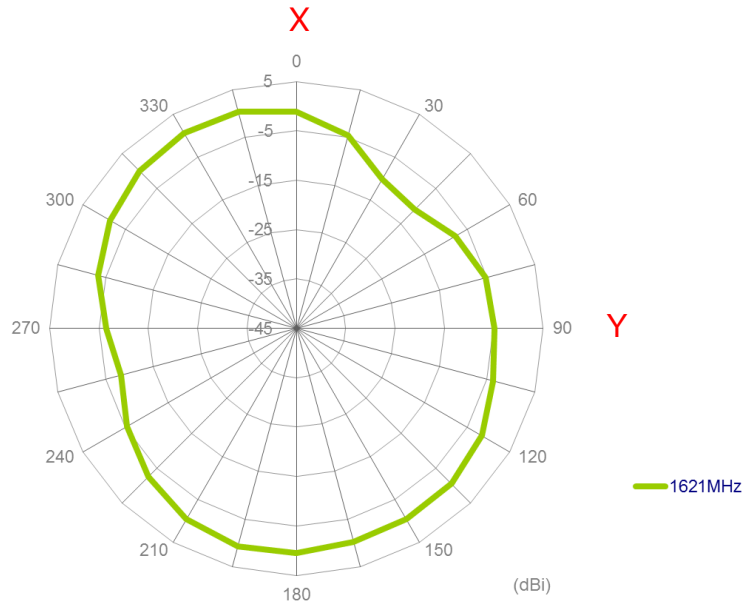

3D Radiation Pattern

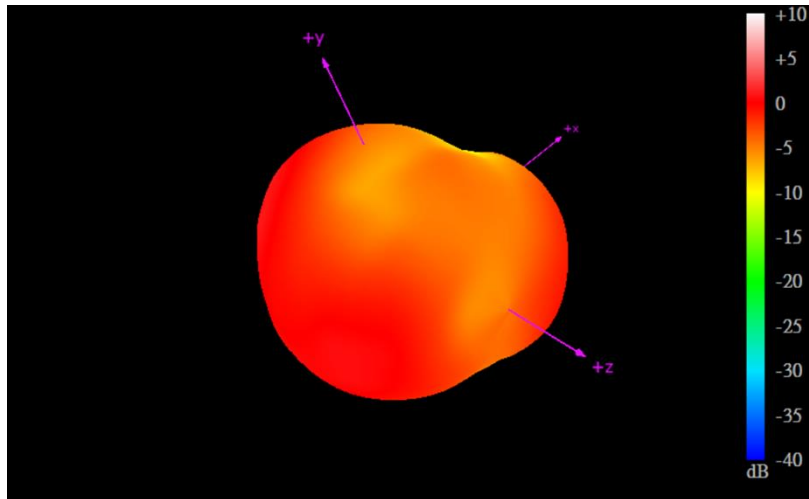

1621MHz

3.2.8 Axial Ratio

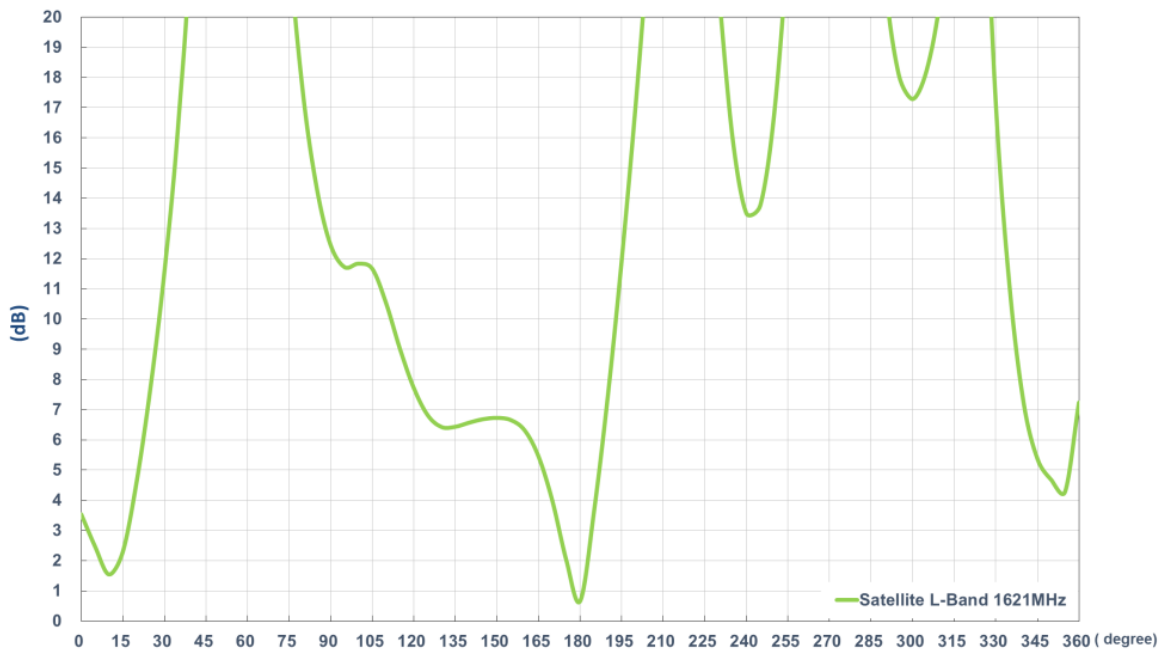

3.3 LTE_MIMO/Wi-Fi_MIMO Antenna

3.3.1 Test Setup

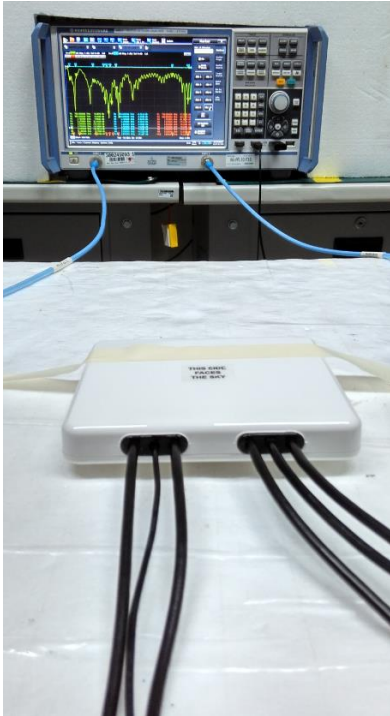

Free space



ABS

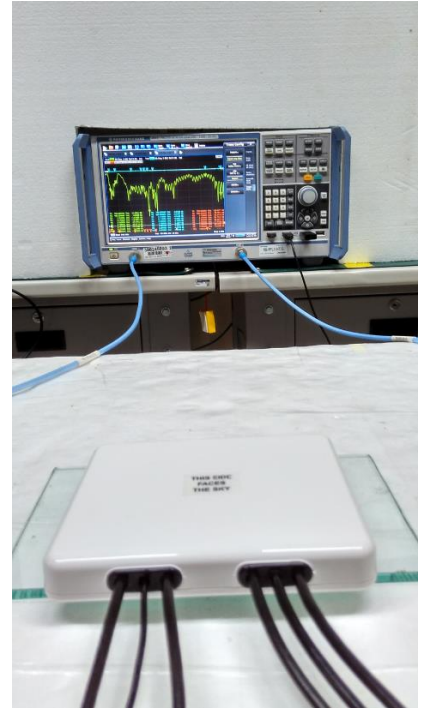

Glass

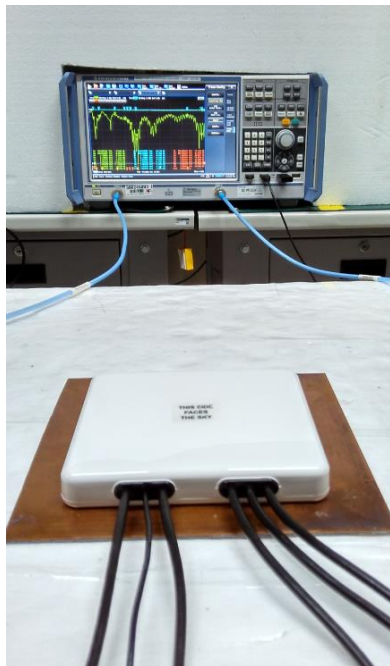

Metal

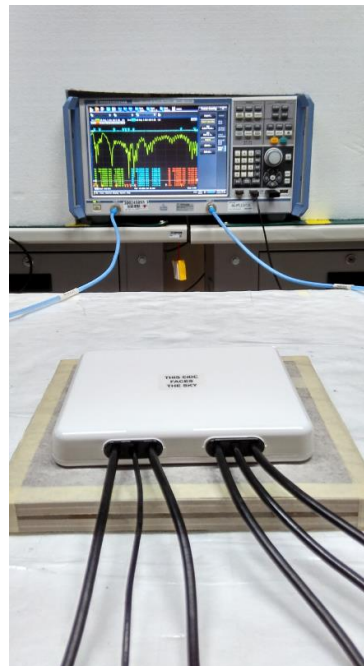

Wall

3.3.2 LTE_1 Antenna Return Loss

Performance in different environments with 1 meter cable length

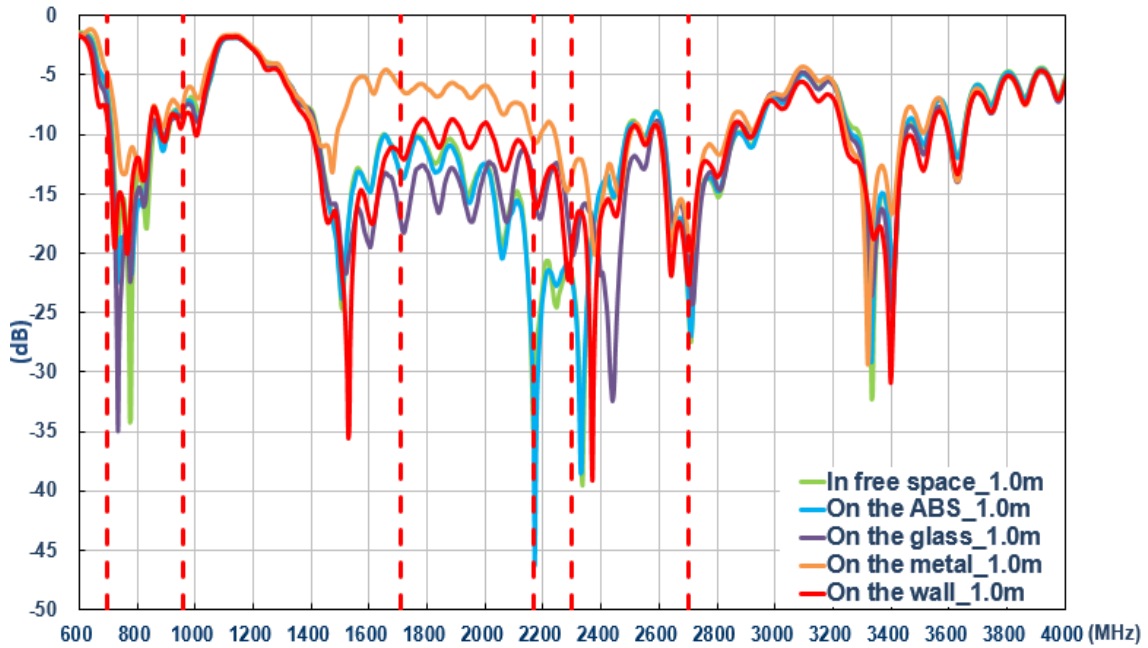

3.3.2 LTE_2 Antenna Return Loss

Performance in different environments with 1 meter cable length

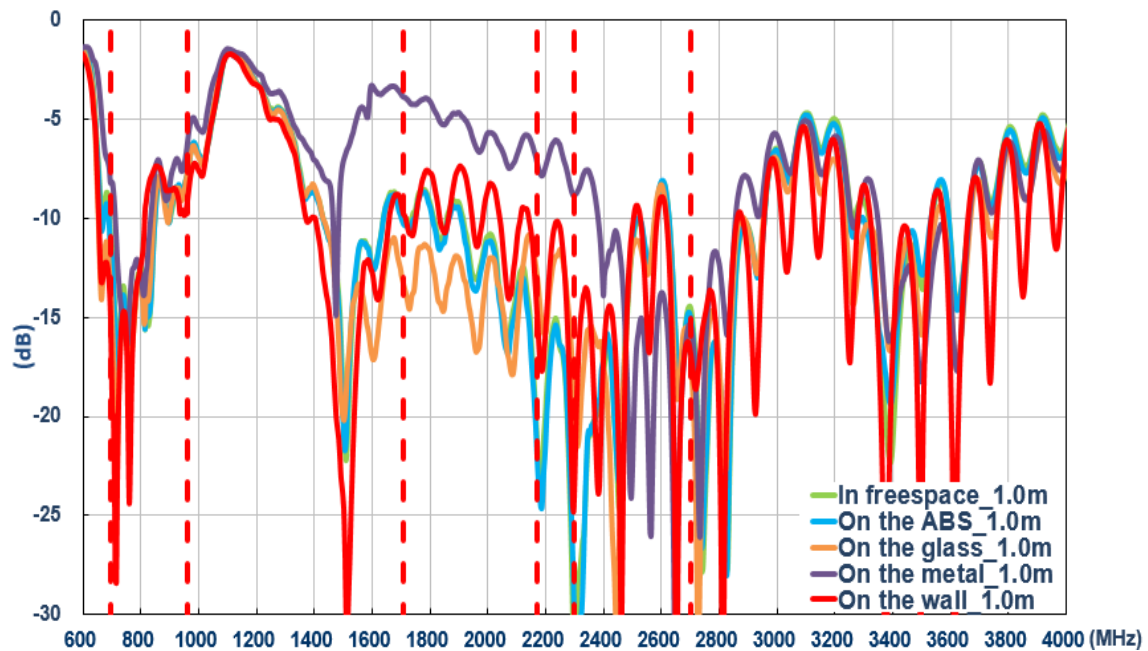

3.3.3 LTE Envelope Correlation Coefficient

Performance in different environments with 1 meter cable length

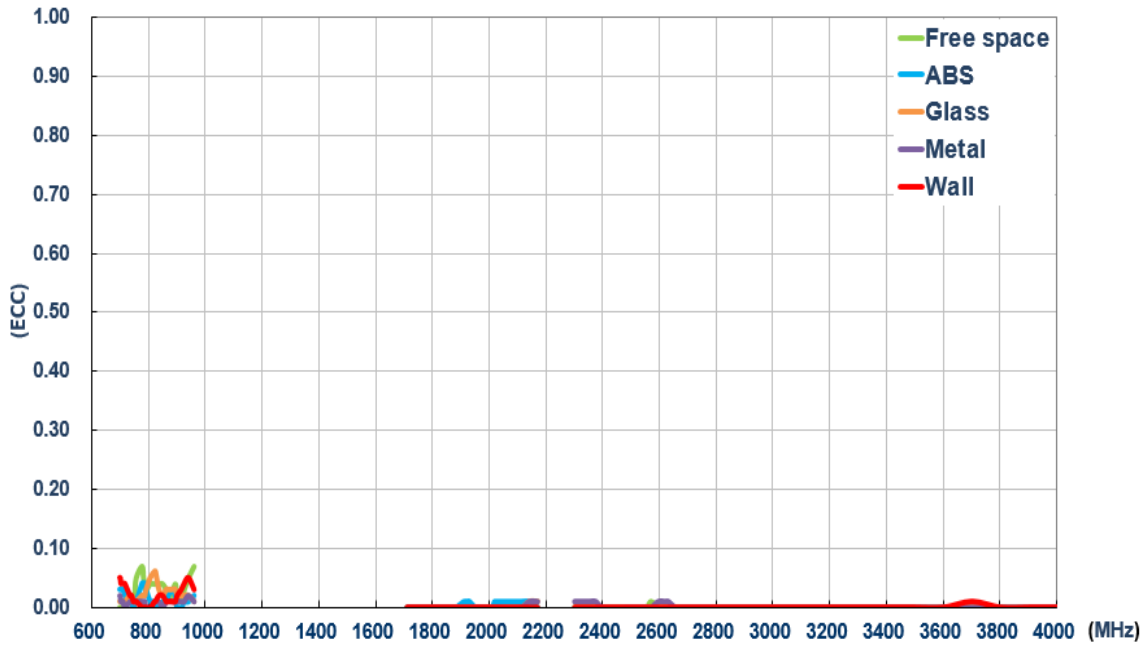

3.3.4 LTE_1 Antenna Efficiency

Performance in different environments with 1 meter cable length

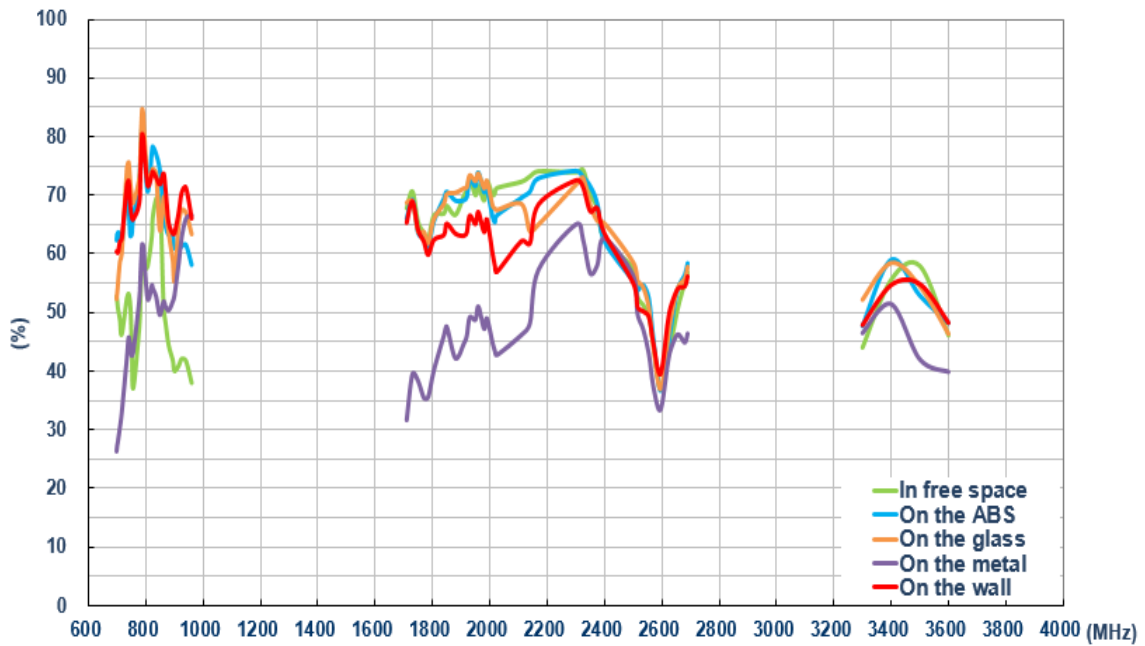

3.3.5 LTE_2 Antenna Efficiency

Performance in different environments with 1 meter cable length

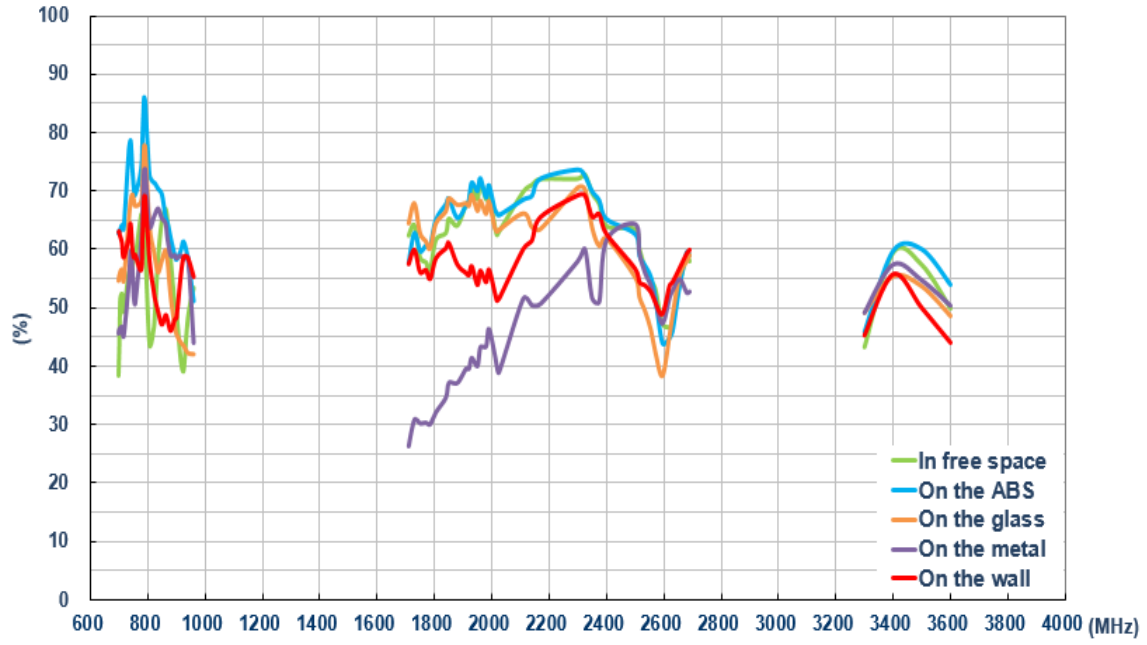

3.3.6 LTE_1 Antenna Average Gain

Performance in different environments with 1 meter cable length

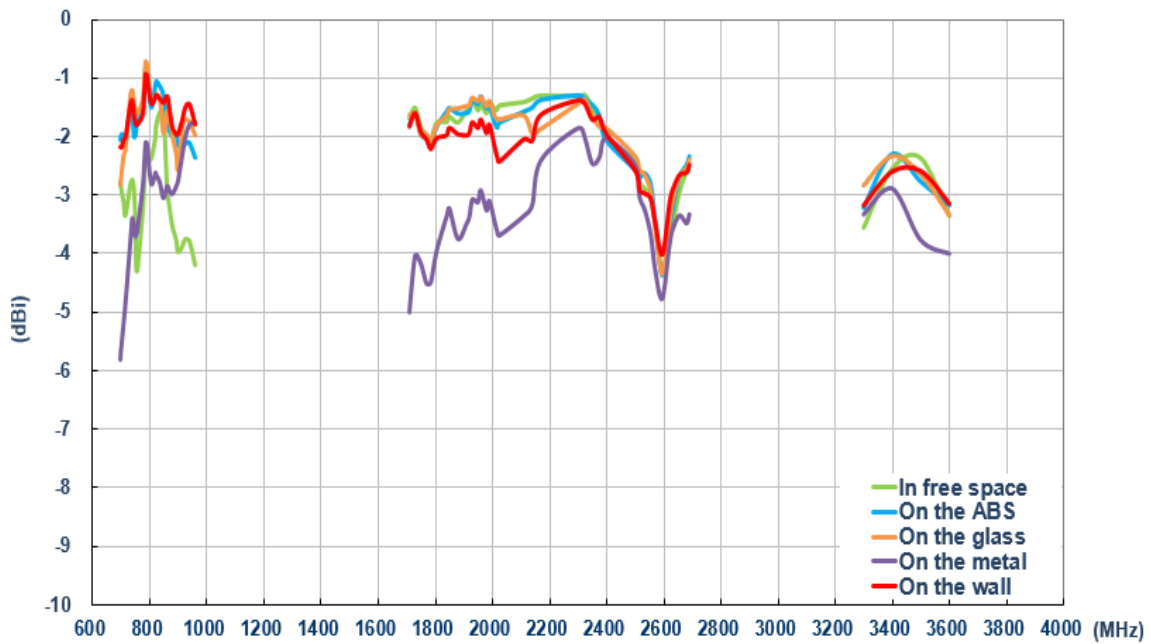

3.3.7 LTE_2 Antenna Average Gain

Performance in different environments with 1 meter cable length

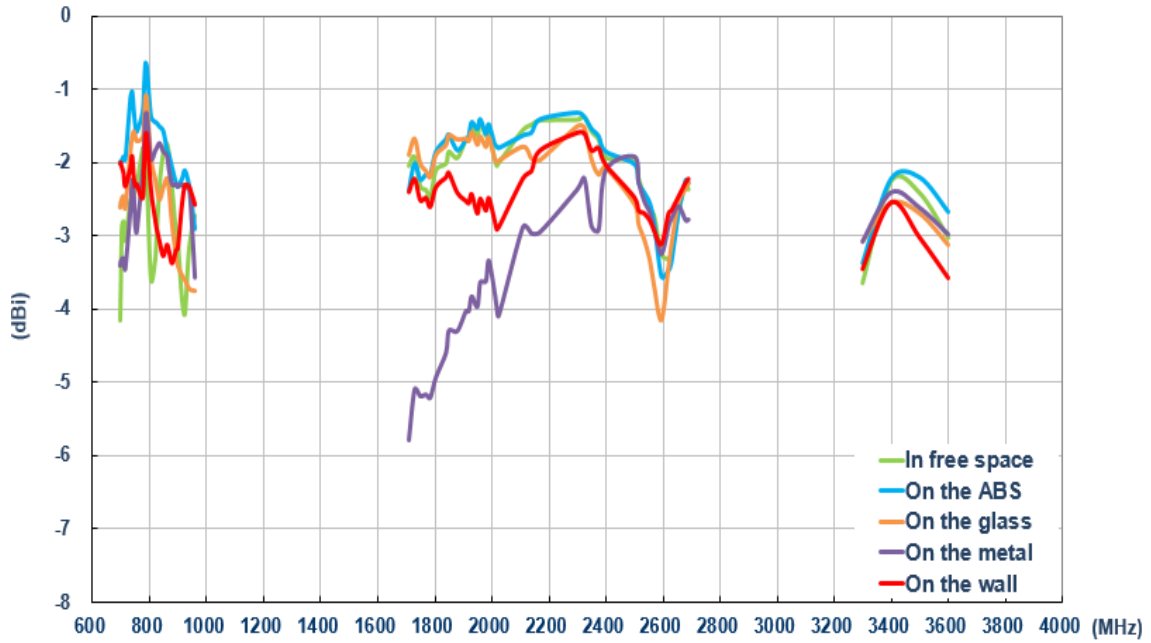

3.3.8 LTE_1 Antenna Peak Gain

Performance in different environments with 1 meter cable length

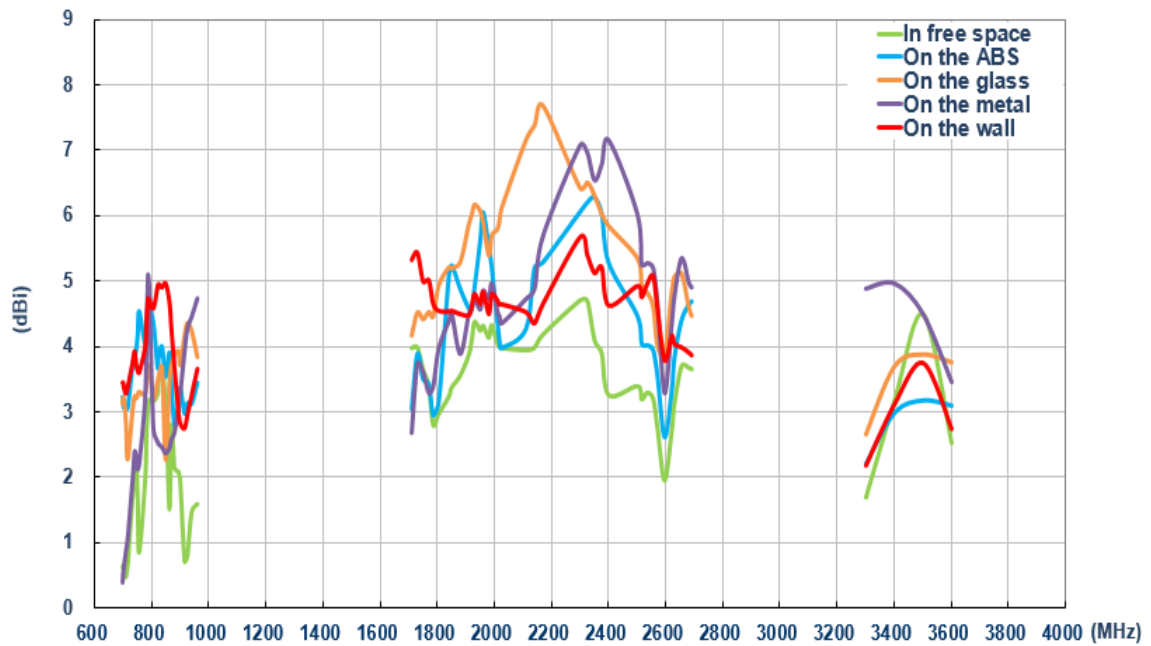

3.3.9 LTE_2 Antenna Peak Gain

Performance in different environments with 1 meter cable length

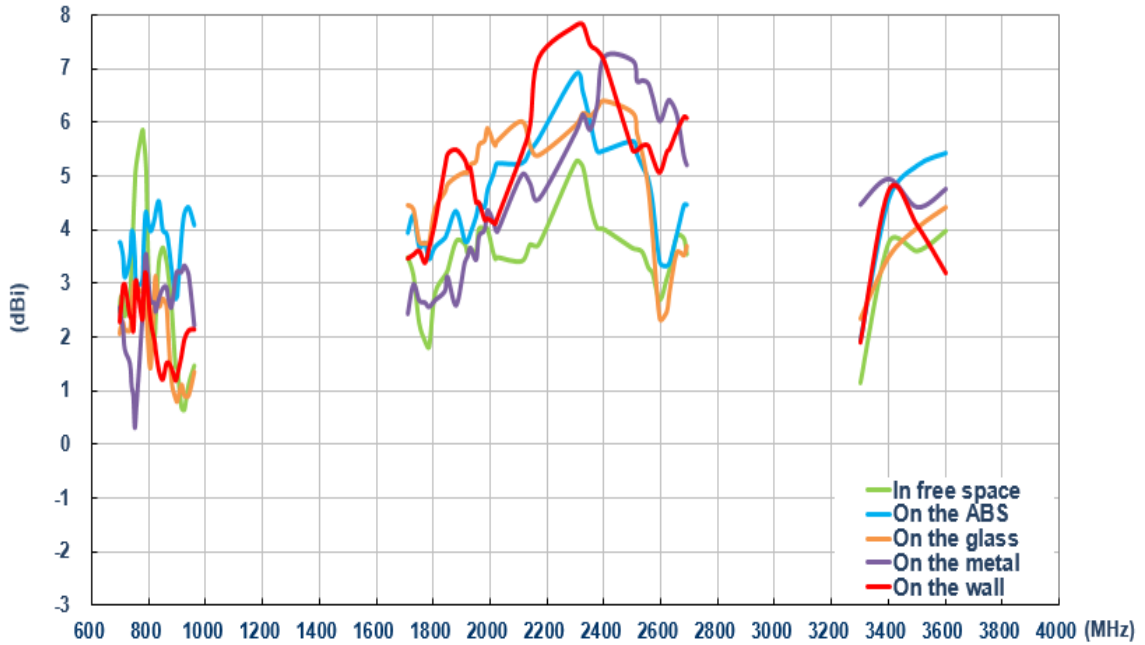

3.3.10 Wi-Fi_1 Antenna Return Loss

Performance in different environments with 1 meter cable length

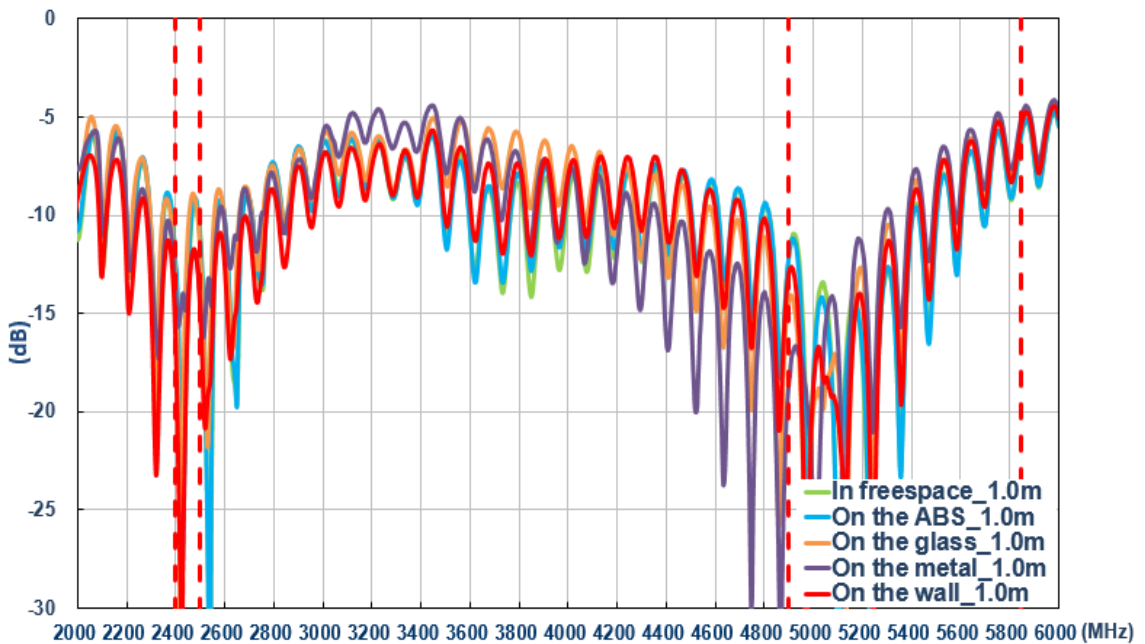

3.3.11 Wi-Fi_2 Antenna Return Loss

Performance in different environments with 1 meter cable length

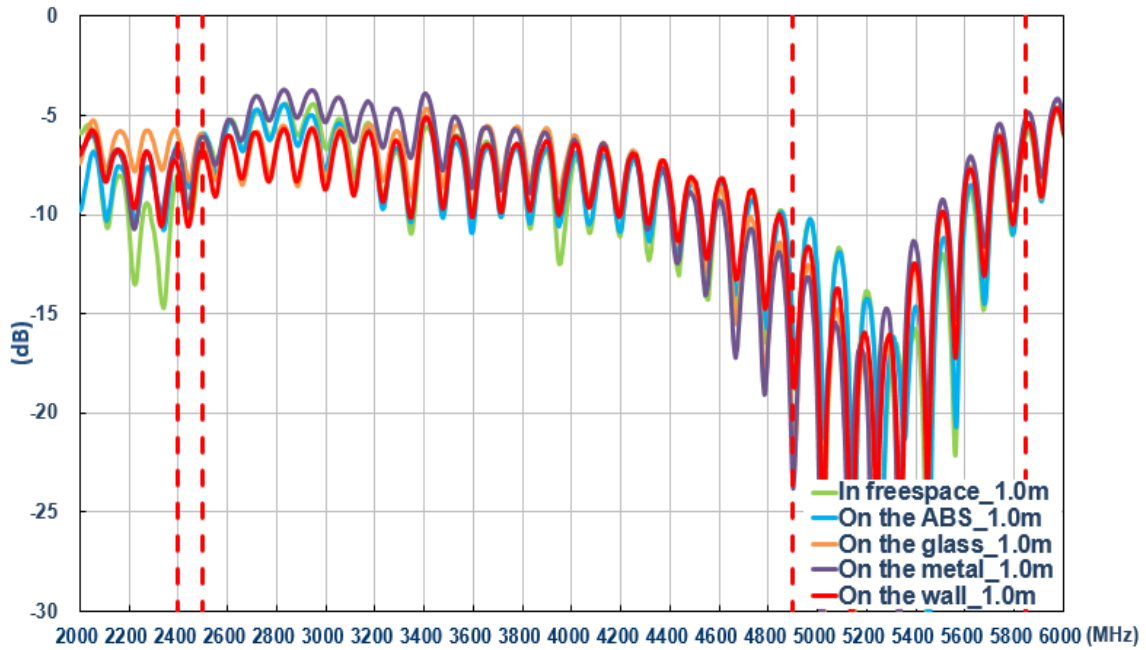

3.3.12 Wi-Fi Envelope Correlation Coefficient

Performance in different environments with 1 meter cable length

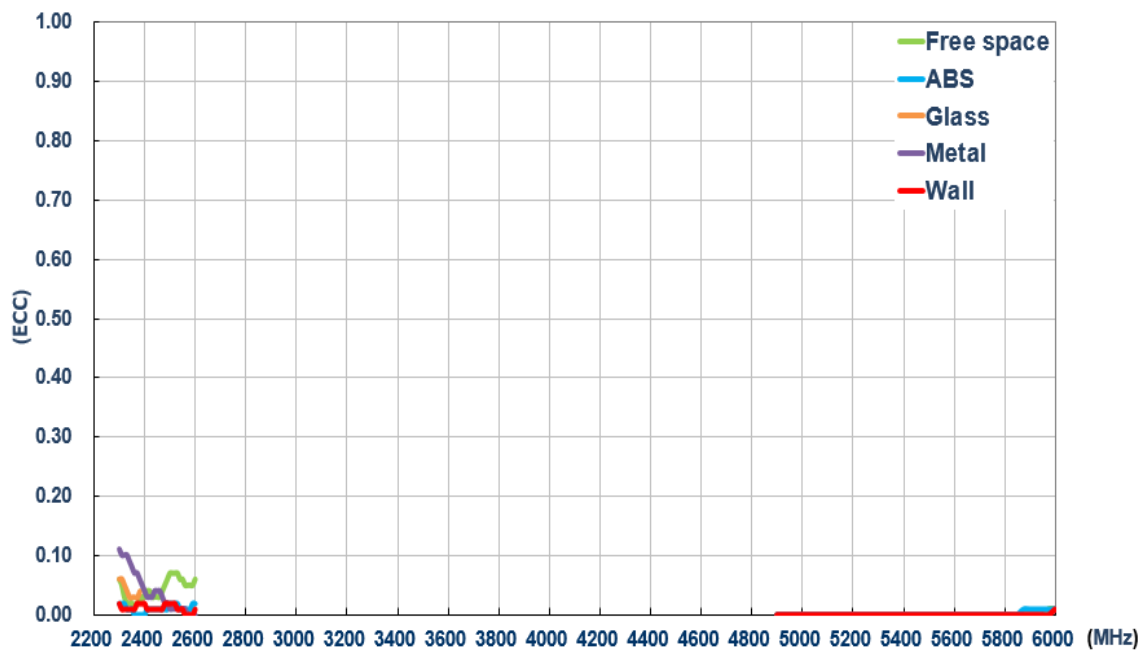

3.3.13 Wi-Fi_1 Antenna Efficiency

Performance in different environments with 1 meter cable length

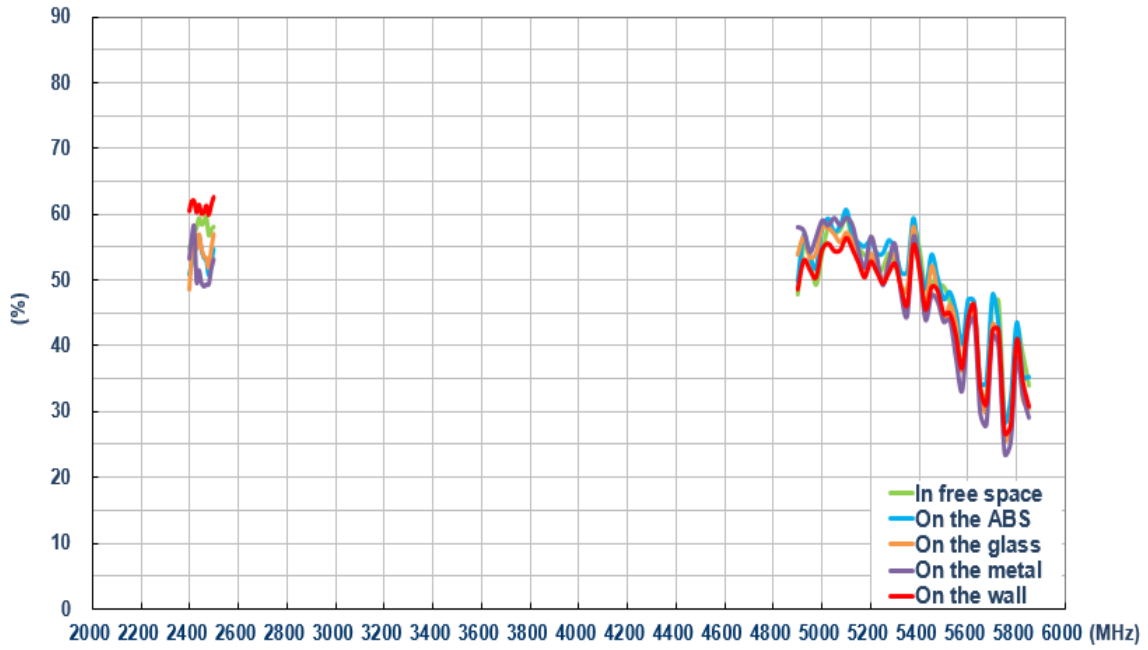

3.3.14 Wi-Fi_2 Antenna Efficiency

Performance in different environments with 1 meter cable length

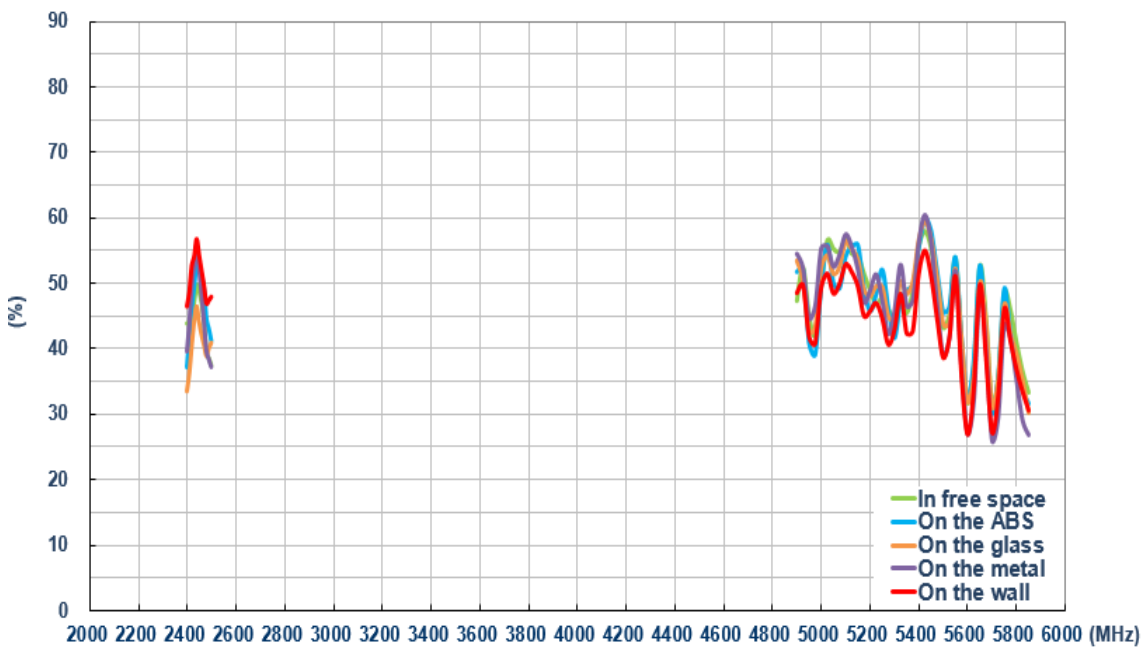

3.3.15 Wi-Fi_1 Antenna Average Gain

Performance in different environments with 1 meter cable length

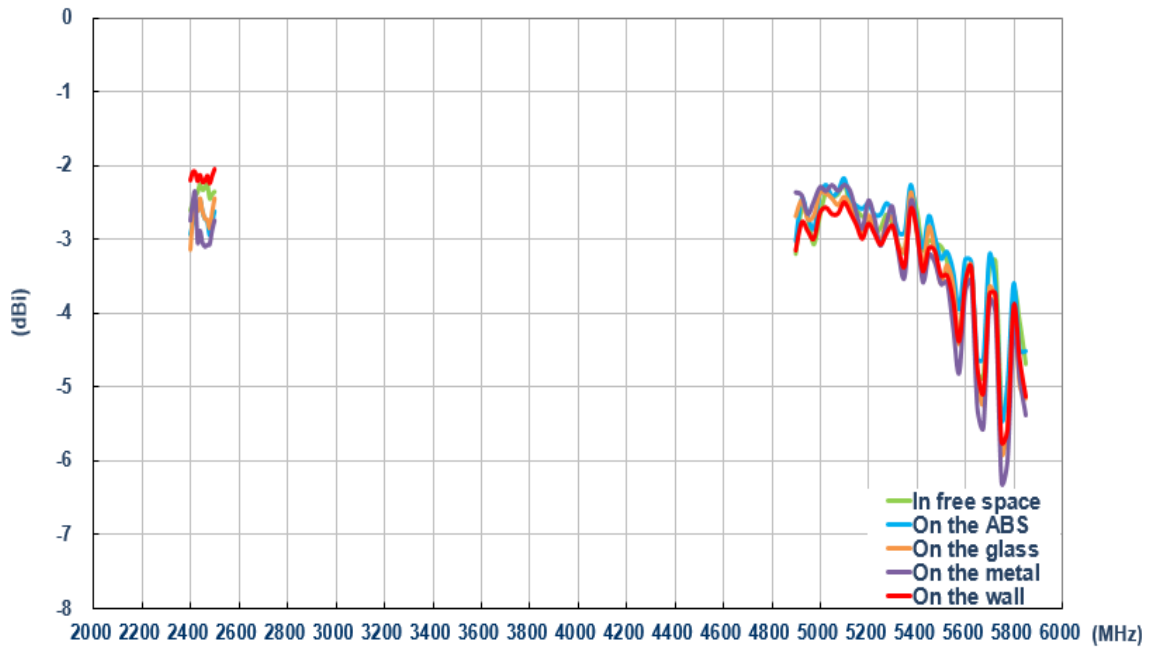

3.3.16 Wi-Fi_2 Antenna Average Gain

Performance in different environments with 1 meter cable length

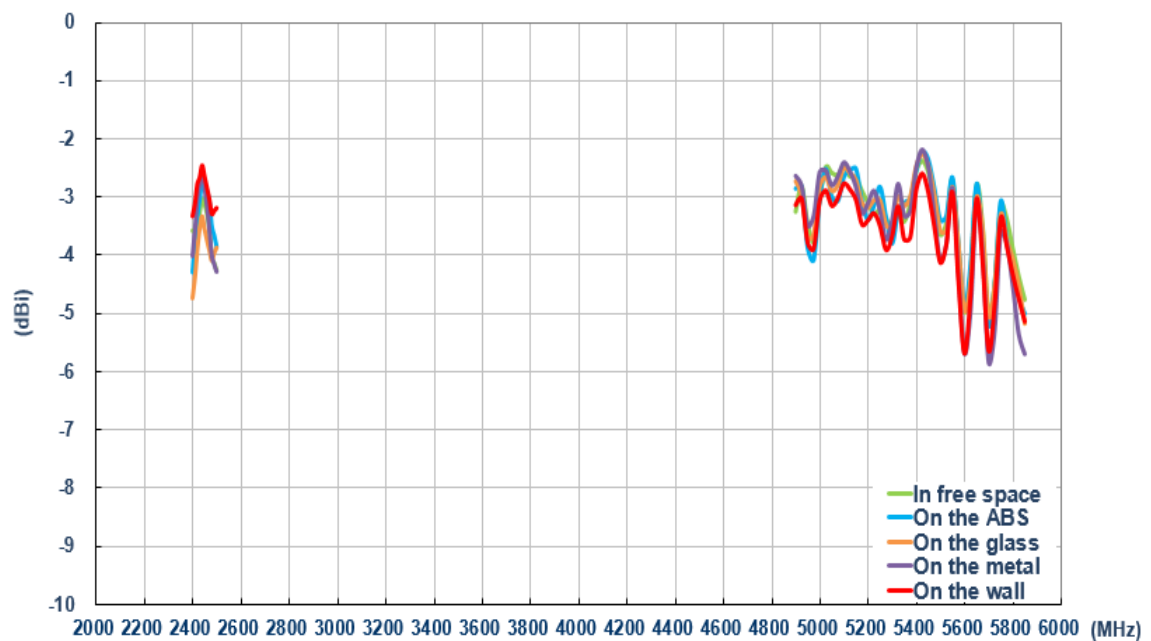

3.3.17 Wi-Fi_1 Antenna Peak Gain

Performance in different environments with 1 meter cable length

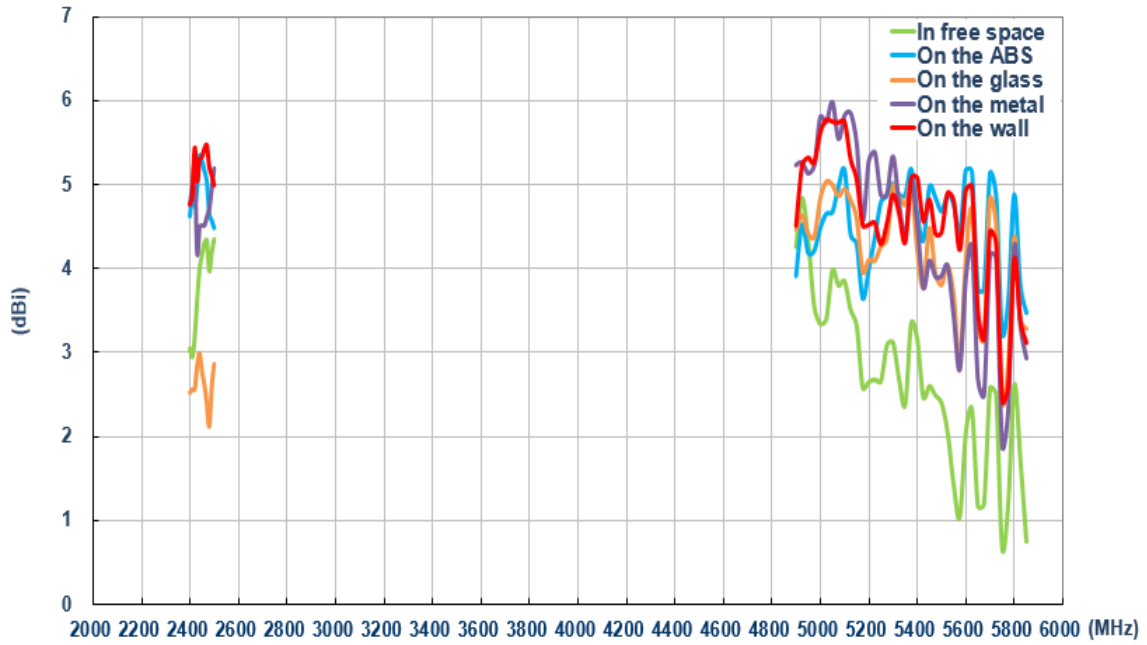

3.3.18 Wi-Fi_2 Antenna Peak Gain

Performance in different environments with 1 meter cable length

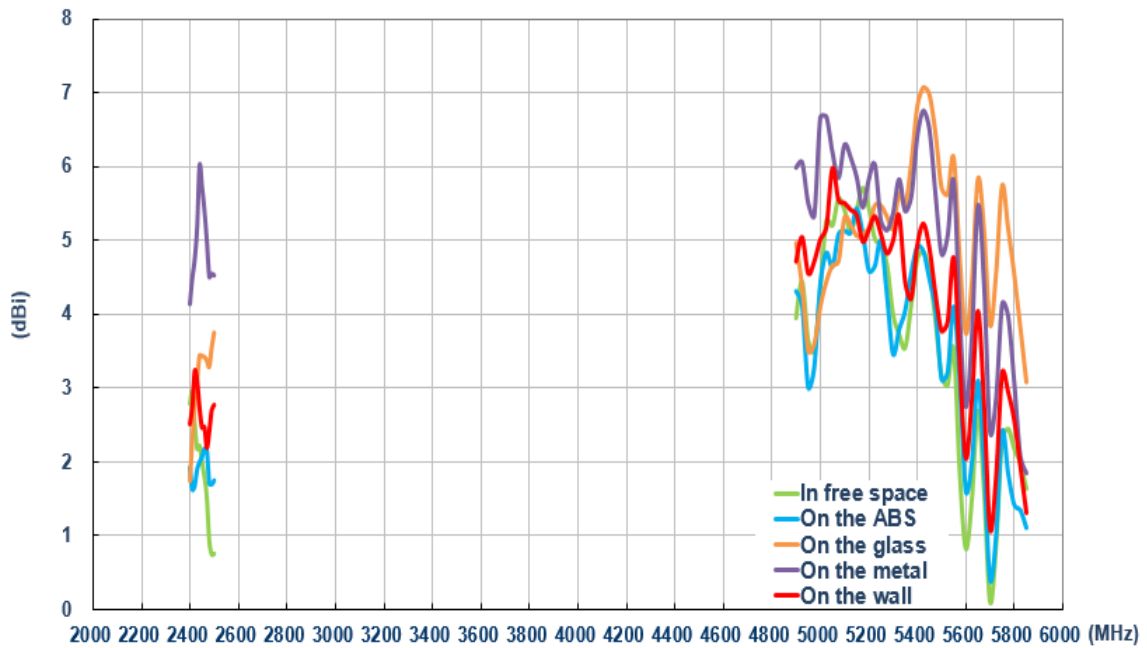

3.3.19 Test Setup for Antenna Radiation Pattern

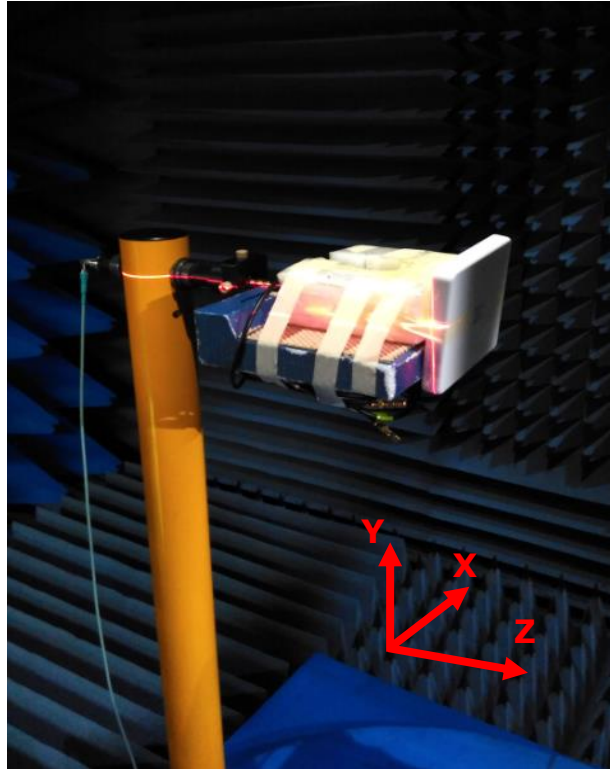

In free space

3.3.20 2D Radiation Pattern (LTE_MIMO1 with 1M cable length in free space)

XY Plane

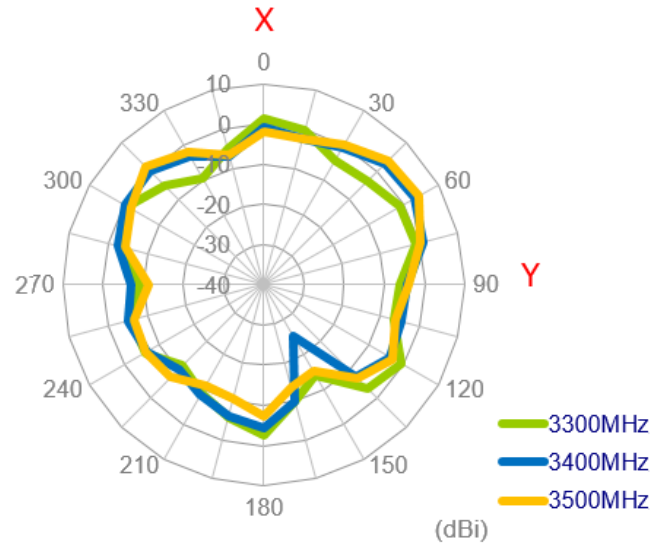
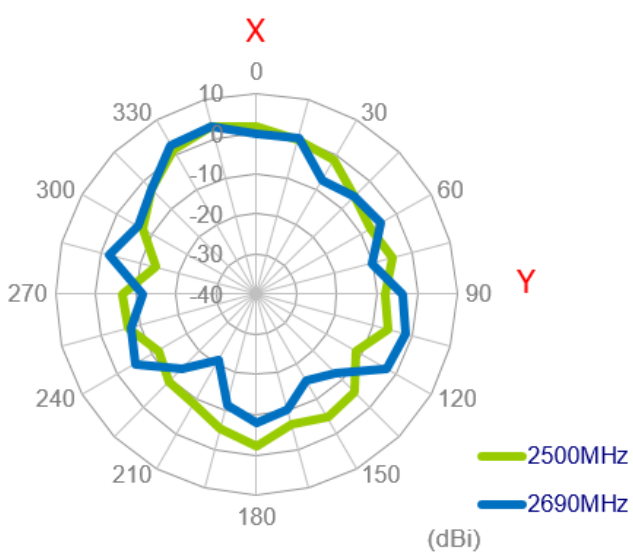
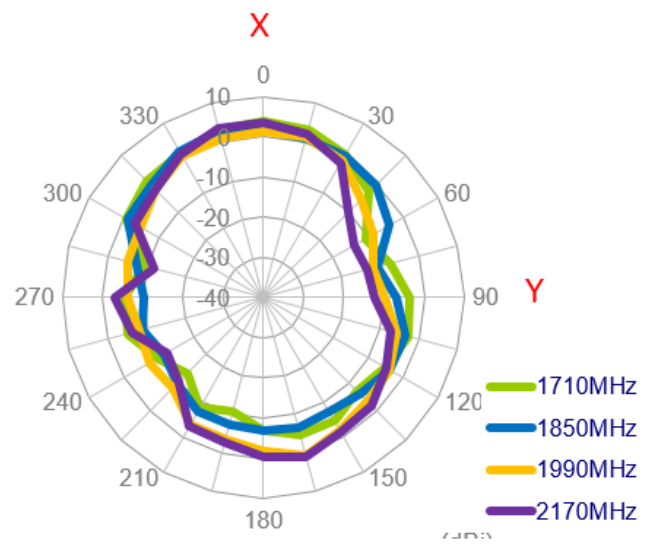
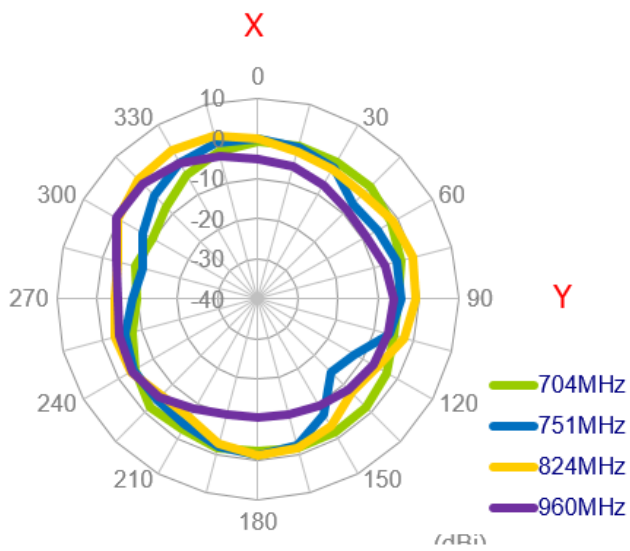

XZ Plane

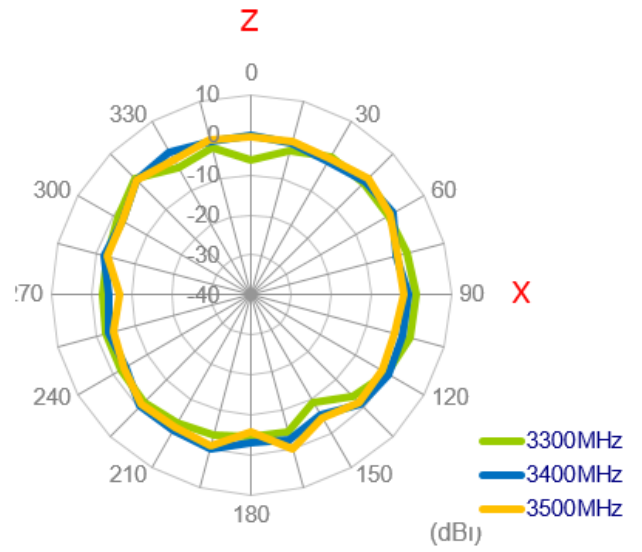
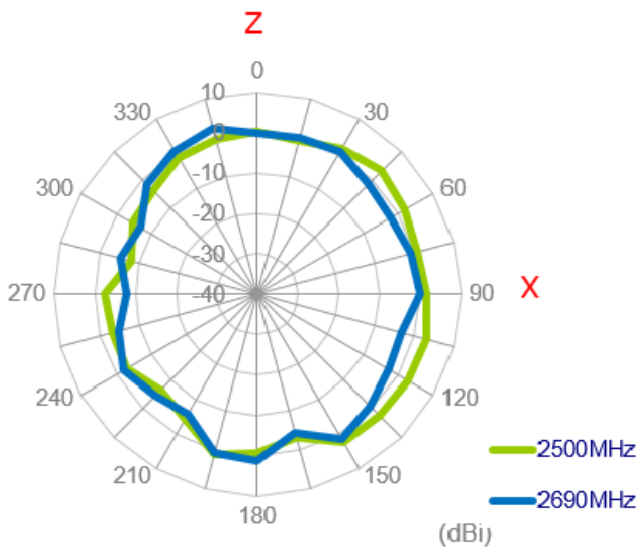
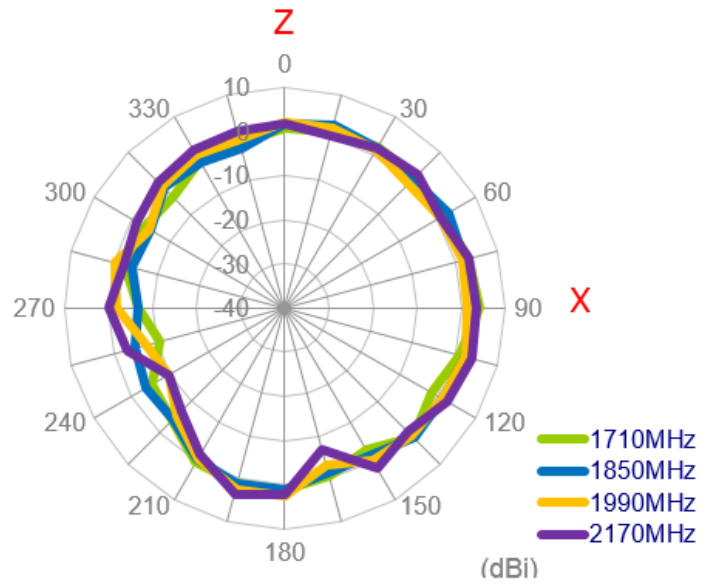
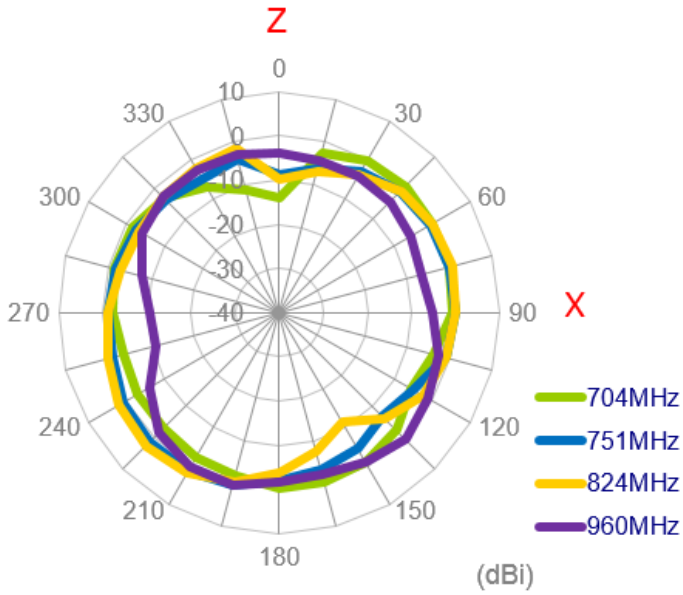

YZ Plane

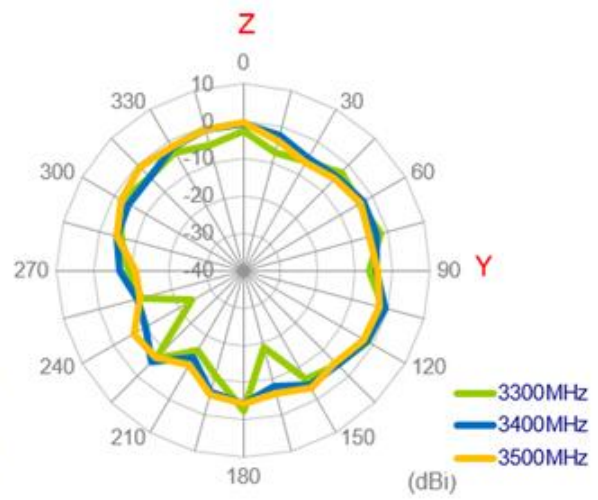
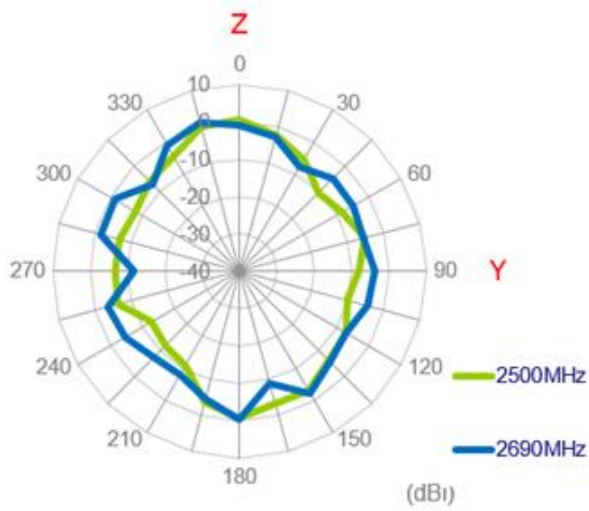
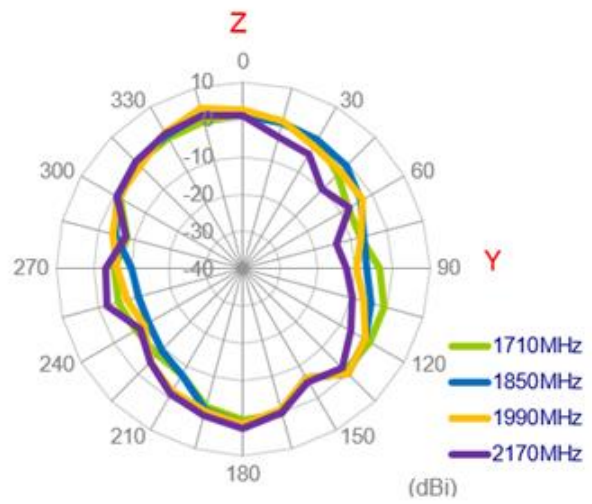
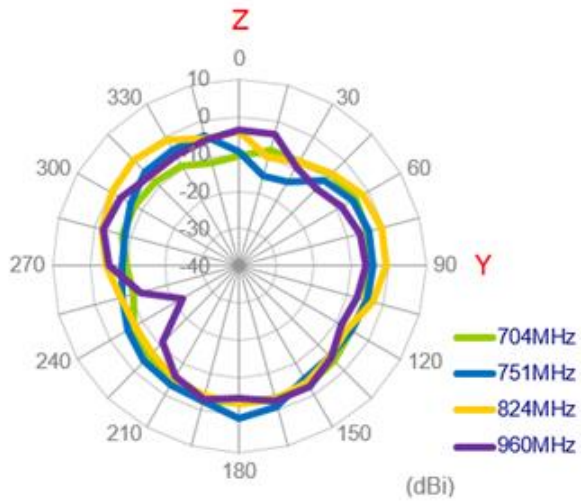

3.3.21 3D Radiation Pattern (LTE_MIMO1 with 1M cable length in free space)

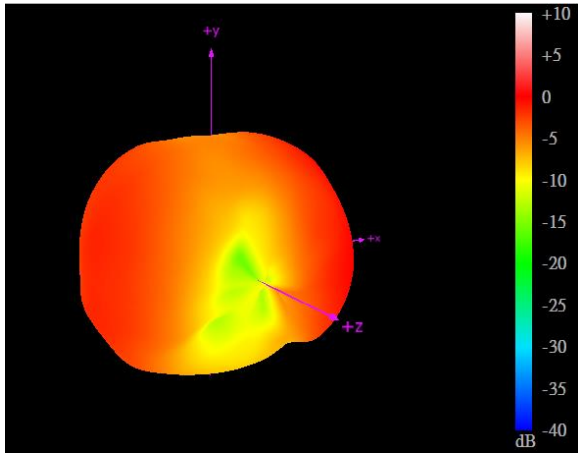

704MHz

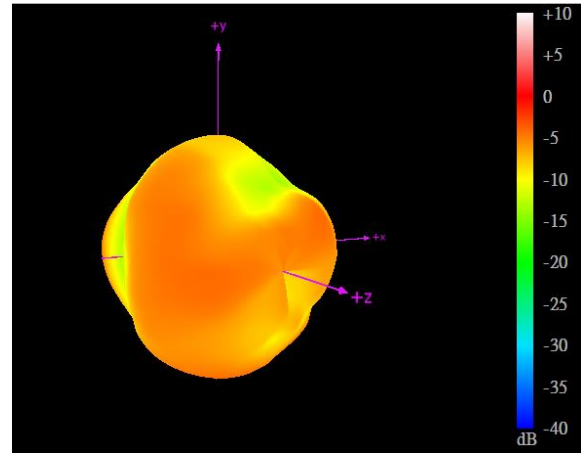

960MHz

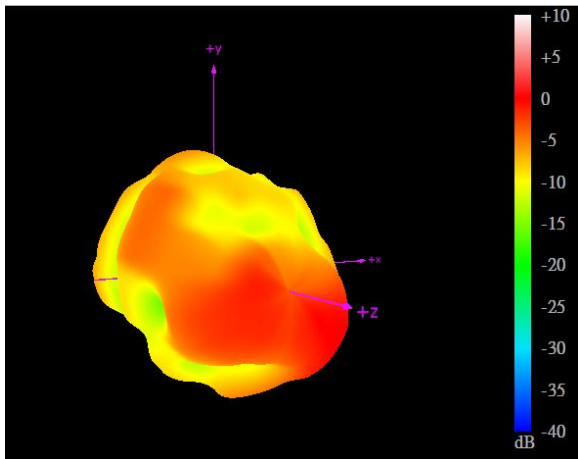

1710MHz

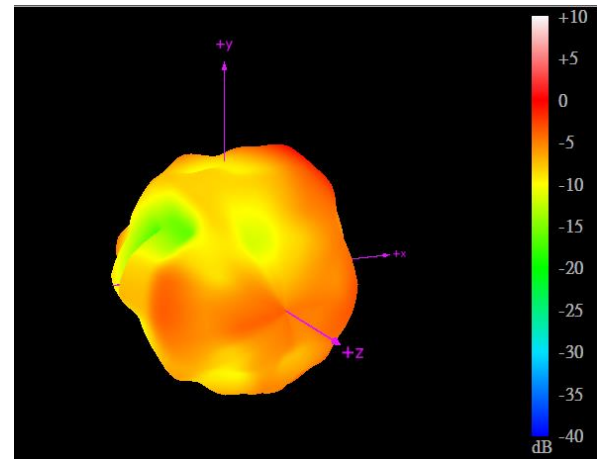

2170MHz

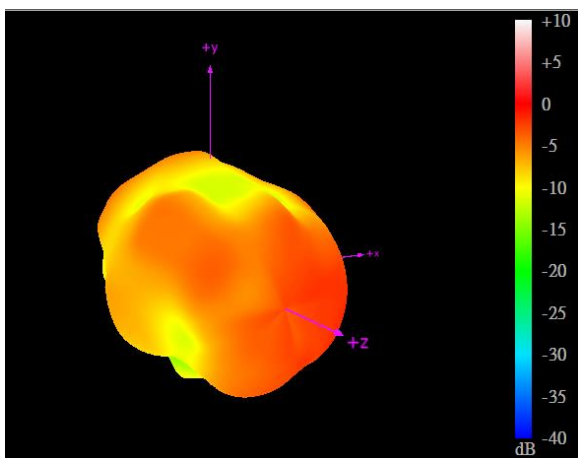

2690MHz

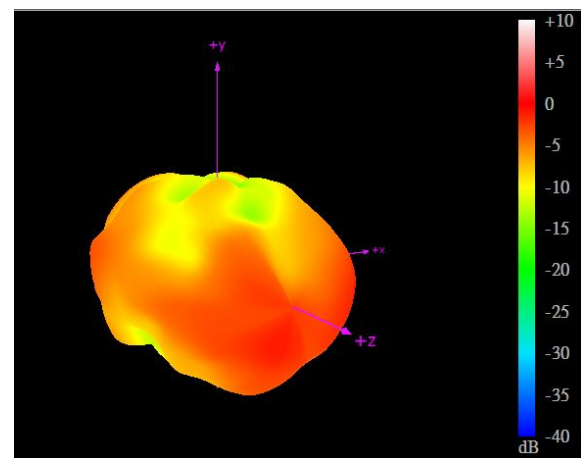

3500MHz

3.3.22 2D Radiation Pattern (LTE_MIMO2 with 1M cable length in free space)

XY Plane

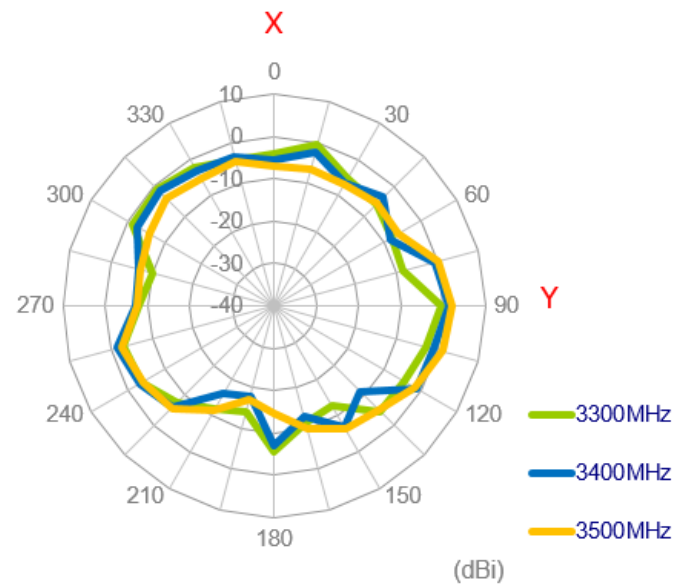
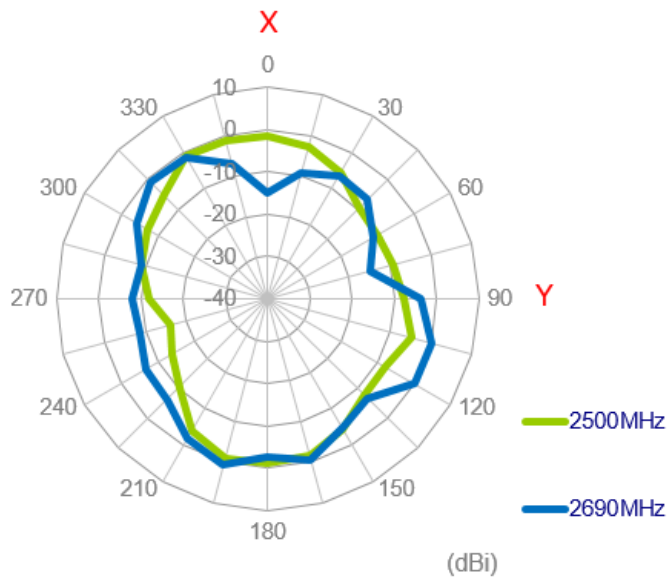
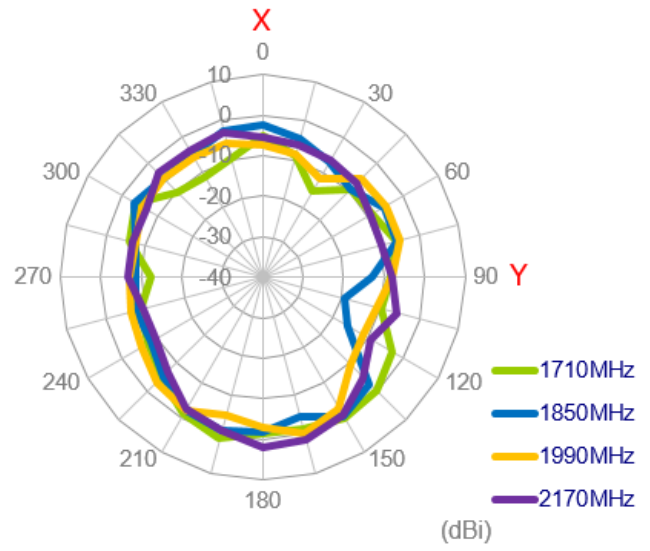
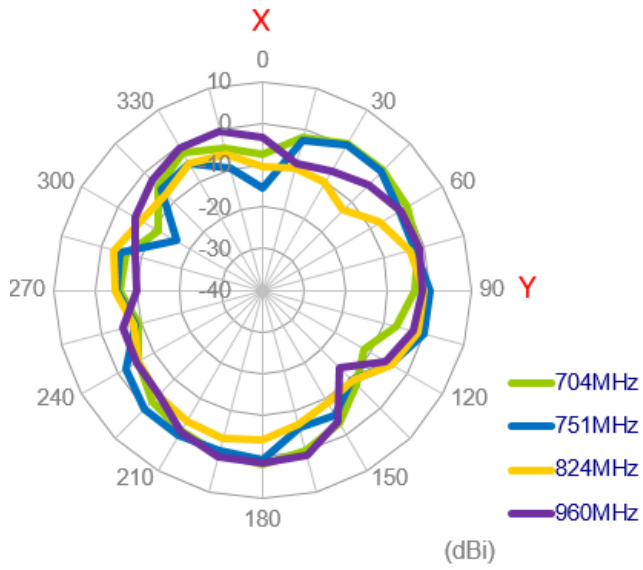

XZ Plane

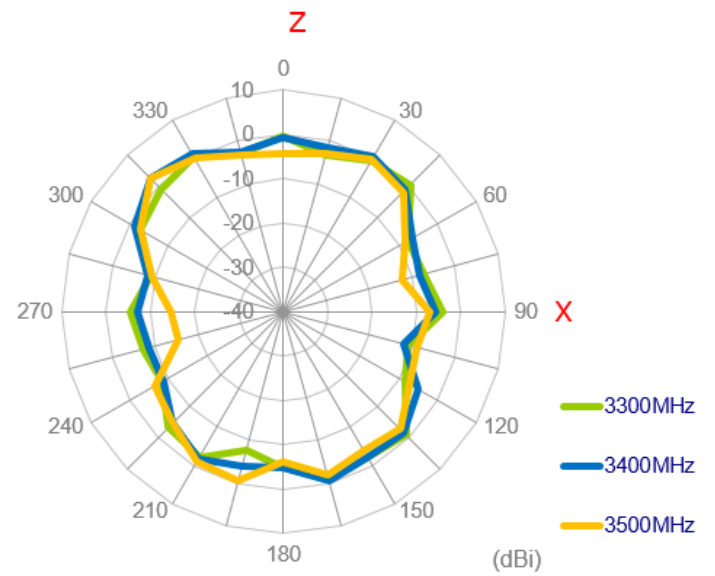
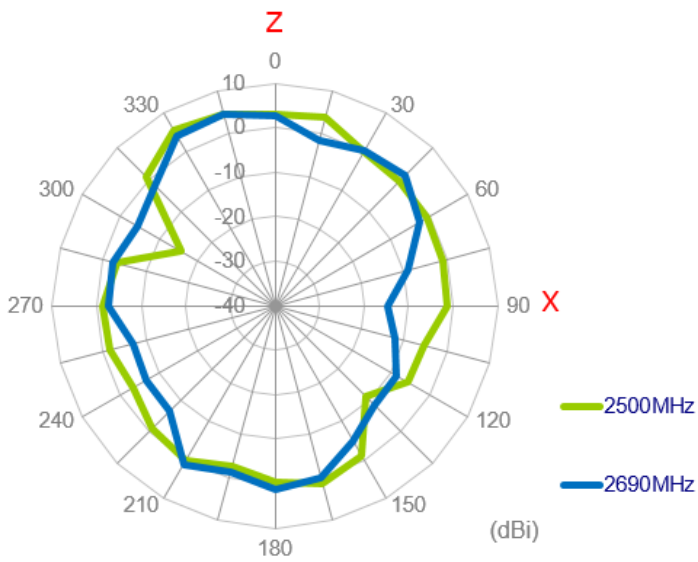
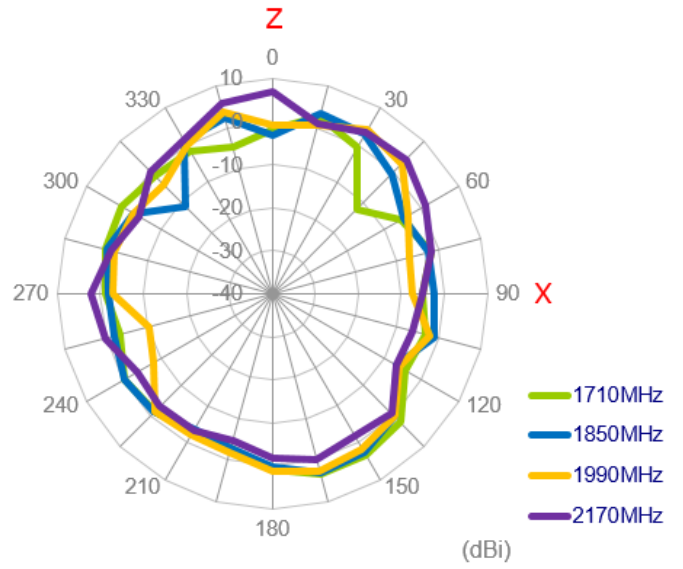
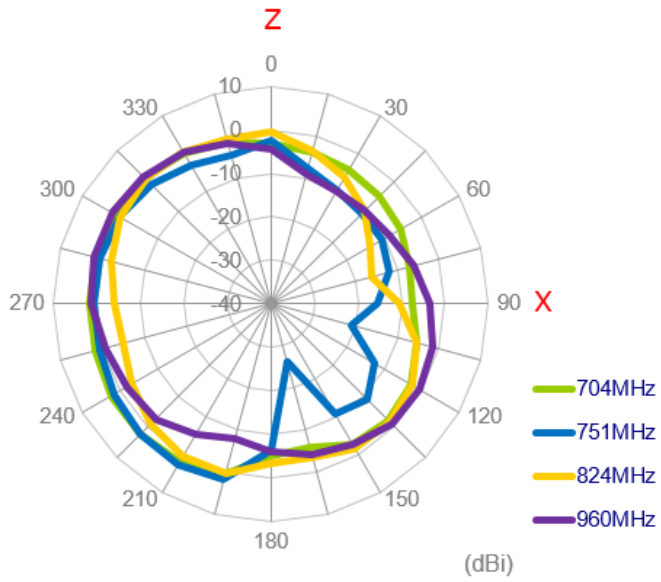

YZ Plane

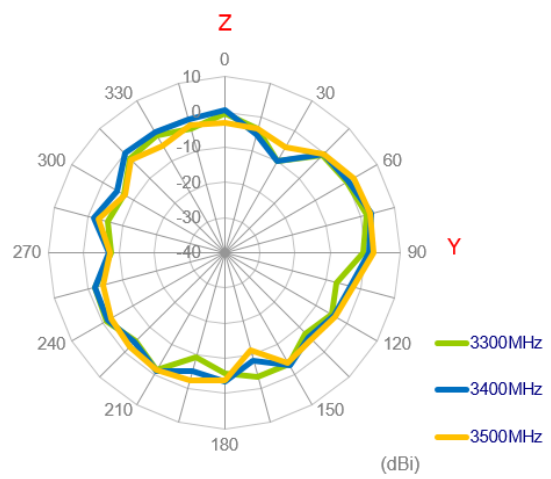
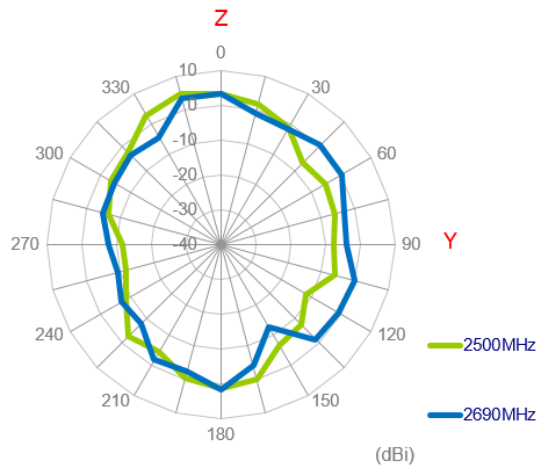
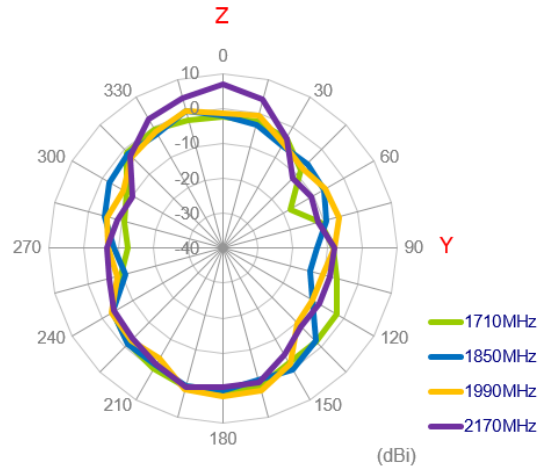
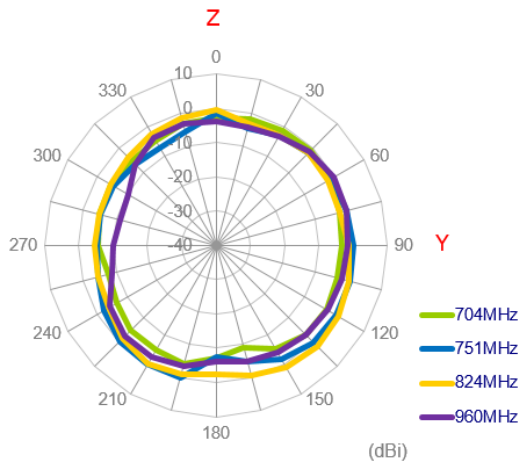

3.3.23 3D Radiation Pattern (LTE_MIMO2 with 1M cable length in free space)

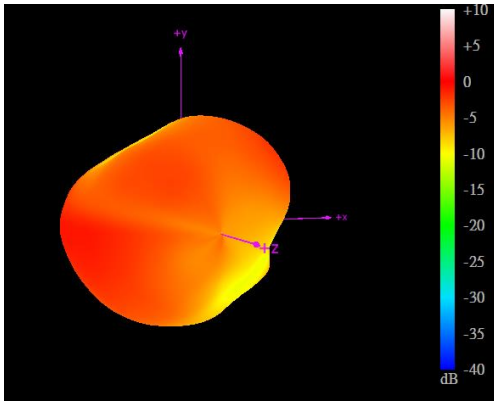

704MHz

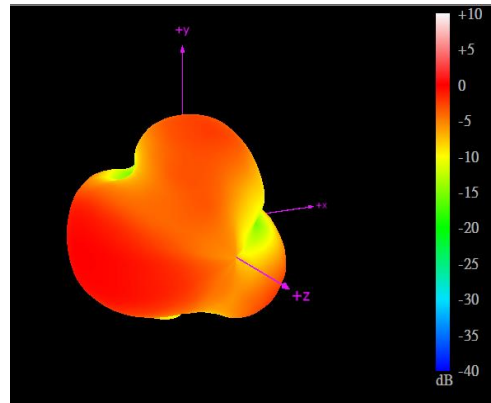

960MHz

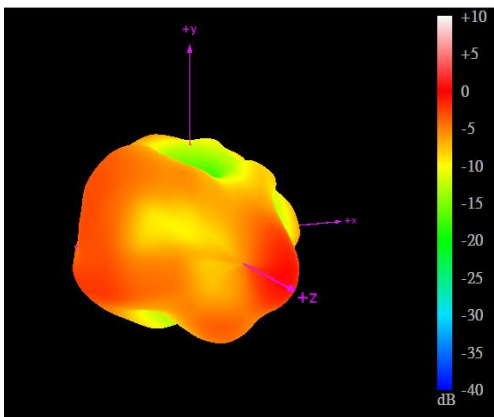

1710MHz

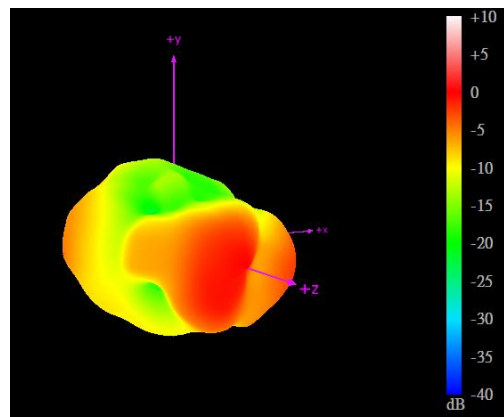

2170MHz

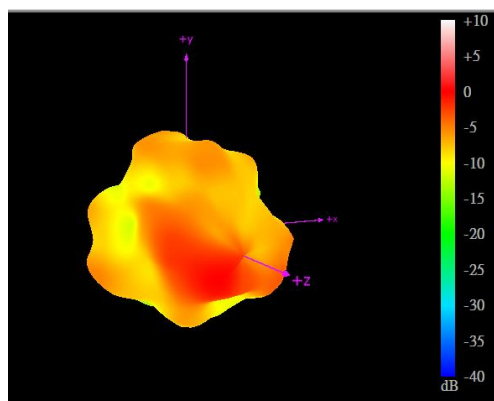

2690MHz

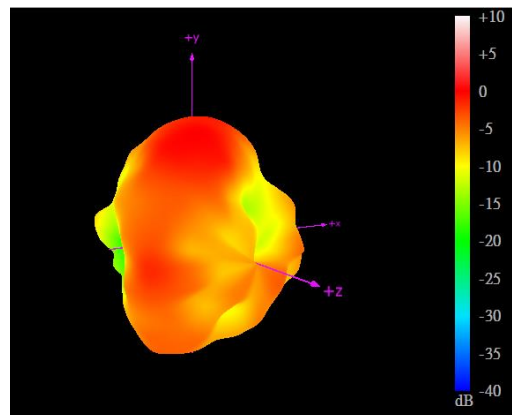

3500MHz

3.3.24 2D Radiation Pattern (Wi-Fi_MIMO1 with 1M cable length in free space)

XY Plane

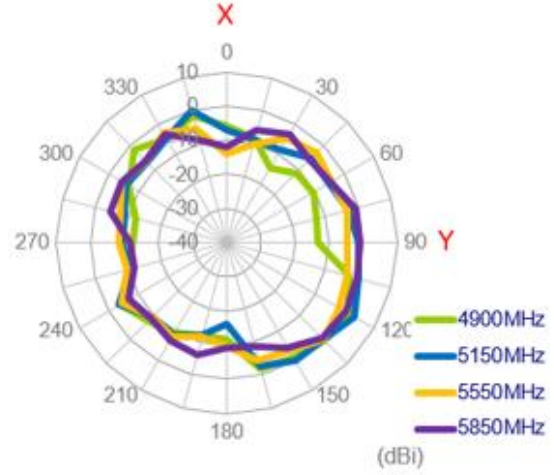
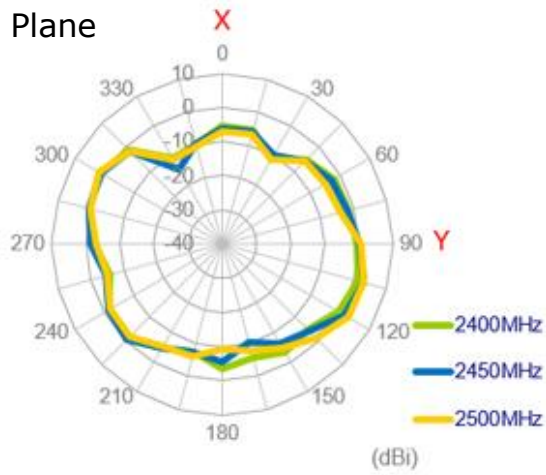

XZ Plane

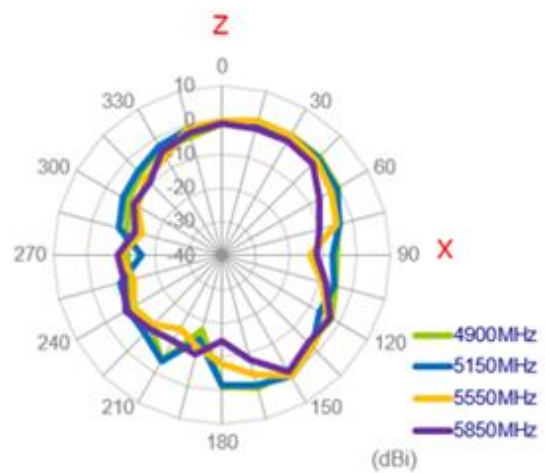
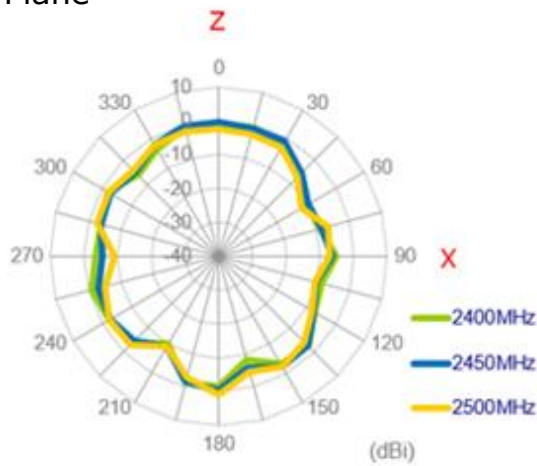

YZ Plane

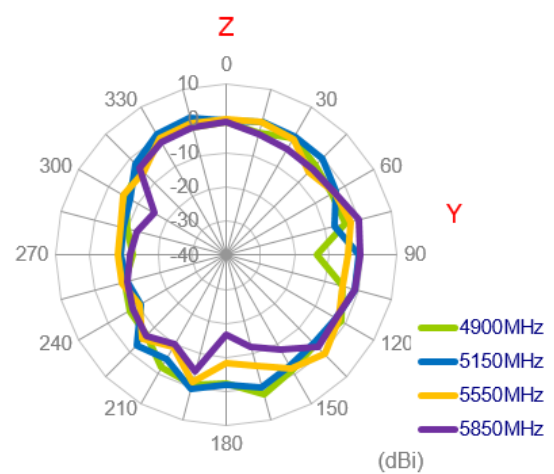
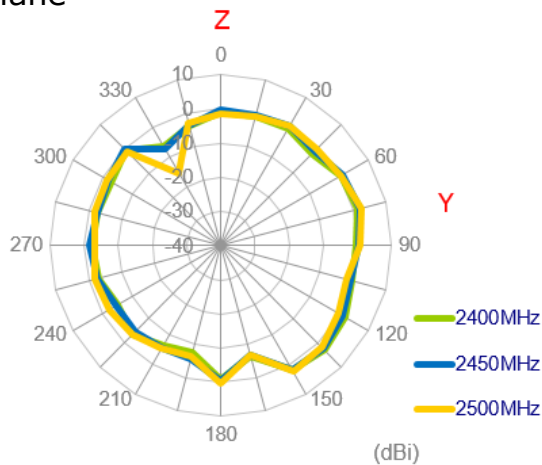

3.3.25 3D Radiation Pattern (Wi-Fi_MIMO1 with 1M cable length in free space)

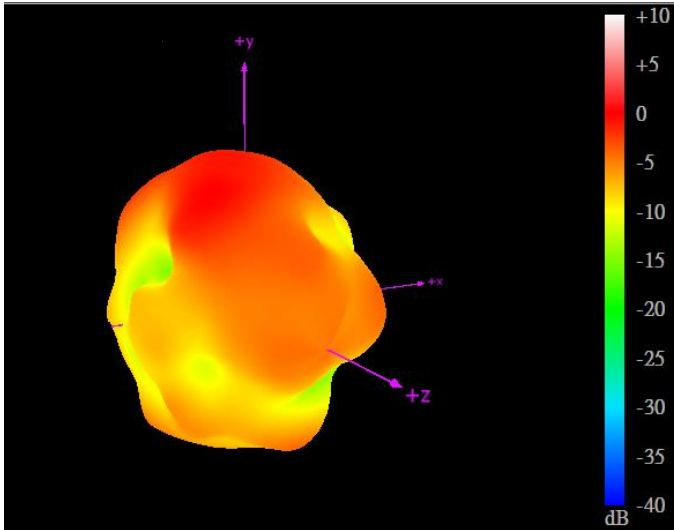

2450MHz

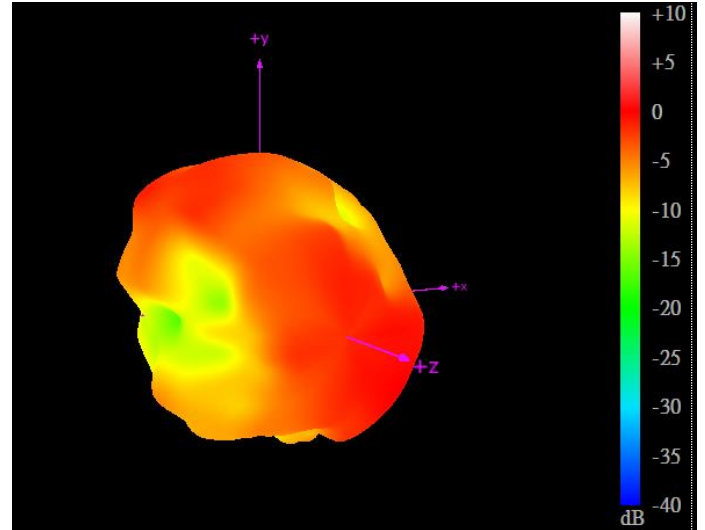

5550MHz

3.3.26 2D Radiation Pattern (Wi-Fi_MIMO2 with 3M cable length in free space)

XY Plane

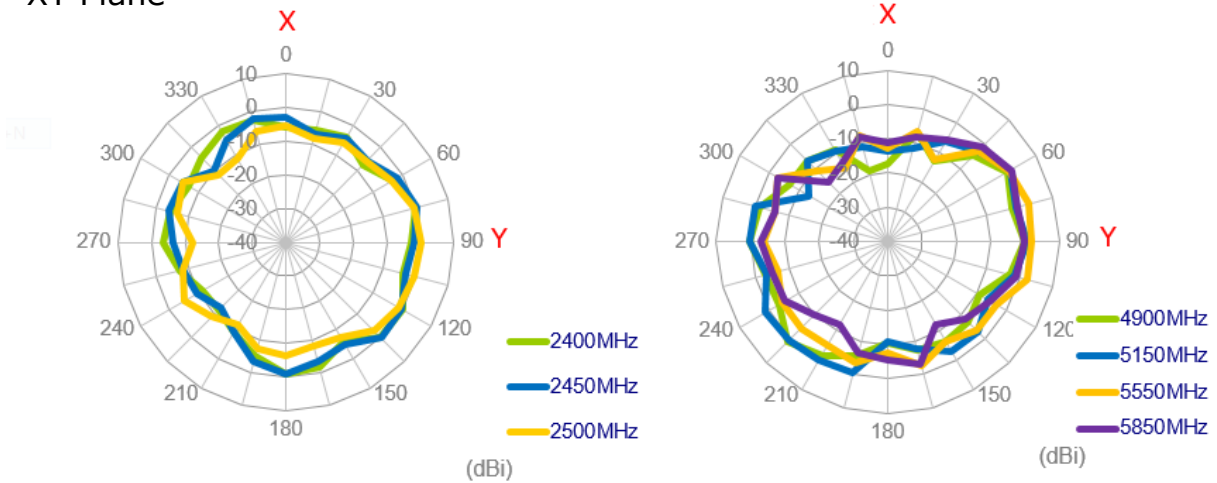

XZ Plane

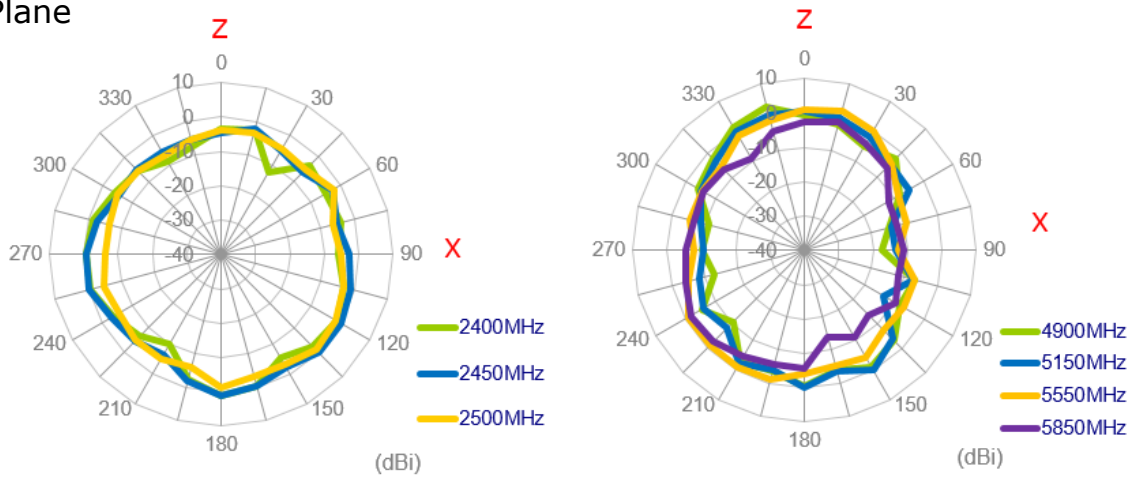

YZ Plane

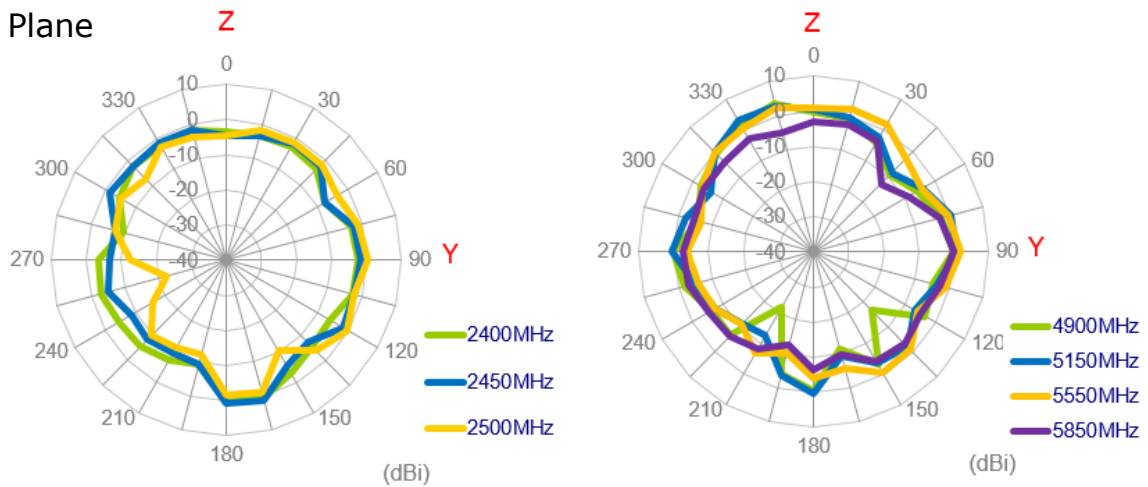

3.3.27 3D Radiation Pattern (Wi-Fi_MIMO2 with 1M cable length in free space)

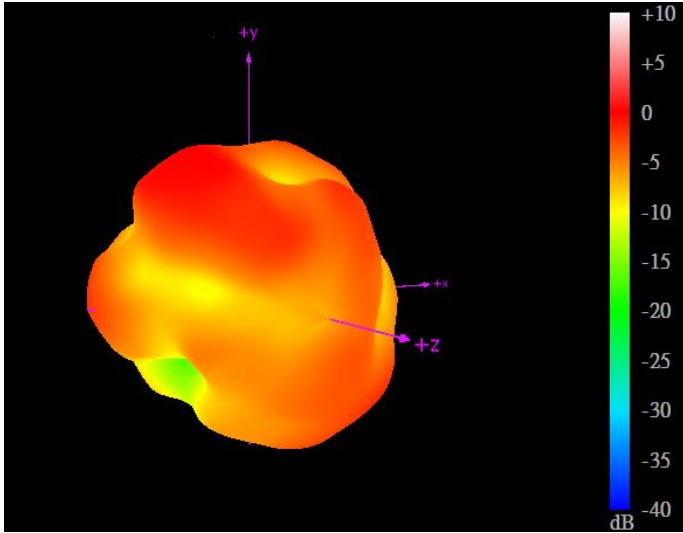

2450MHz

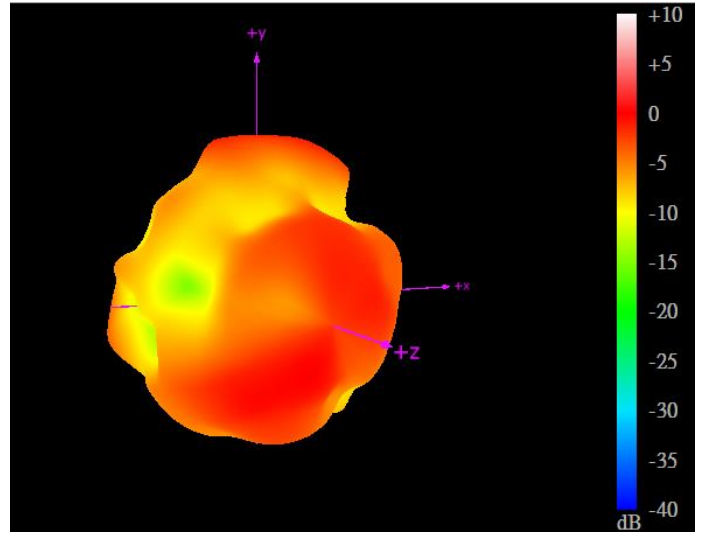

5550MHz

3.3.28 Test Setup for Antenna Radiation Pattern



On the ABS

3.3.29 2D Radiation Pattern (LTE_MIMO1 with 1M cable length on ABS)

XY Plane

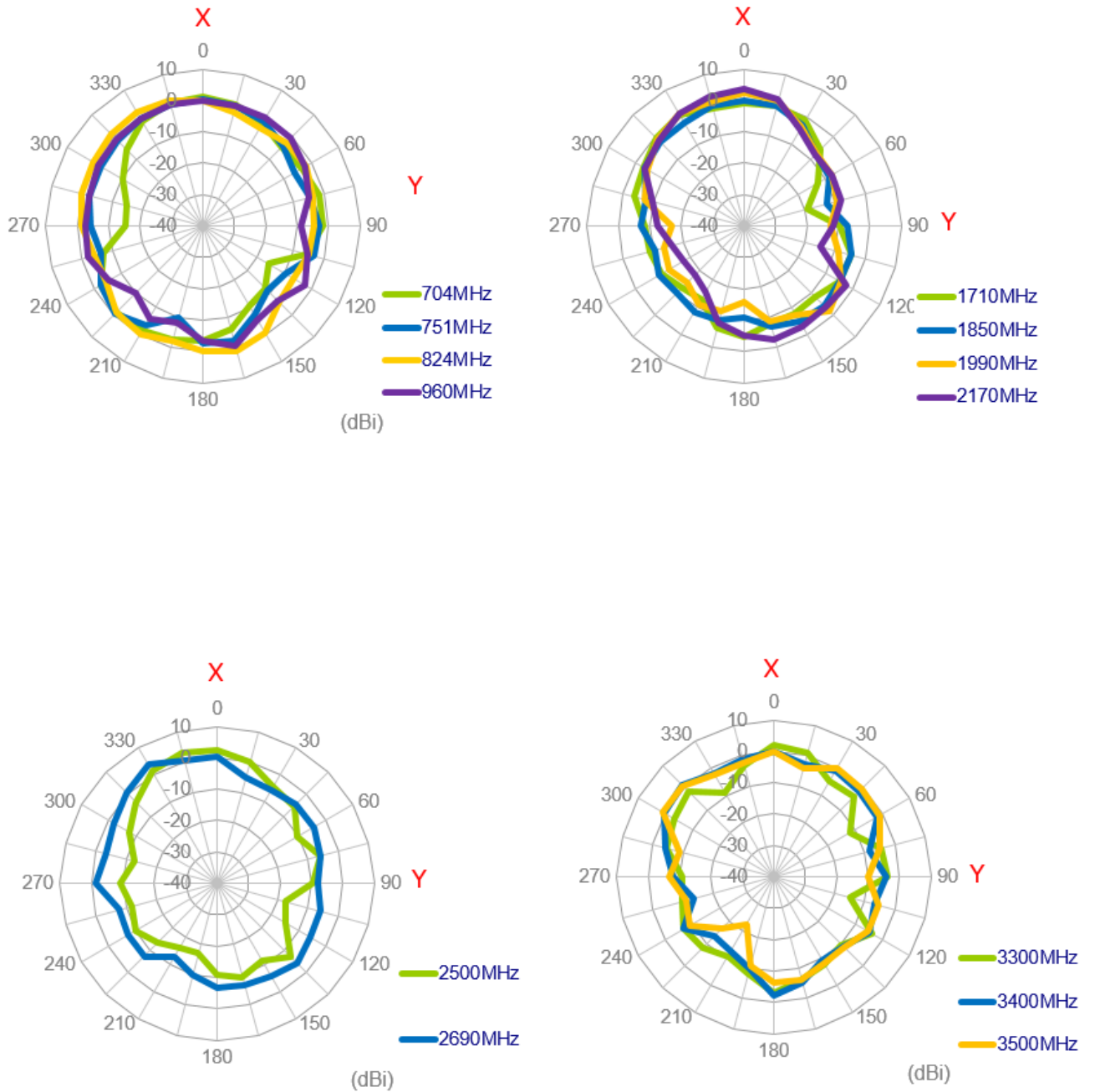

XZ Plane

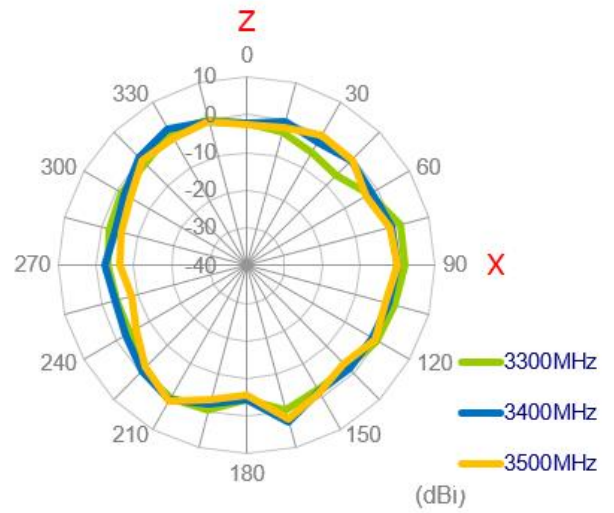
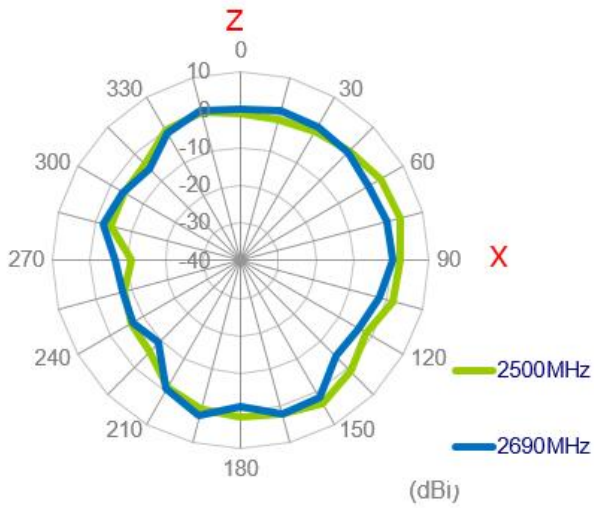
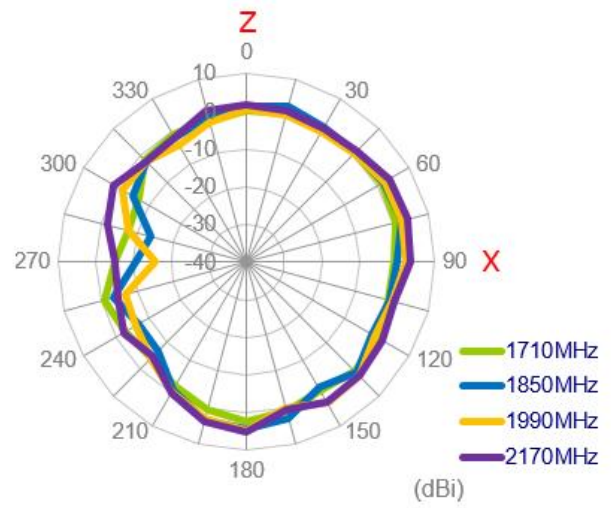
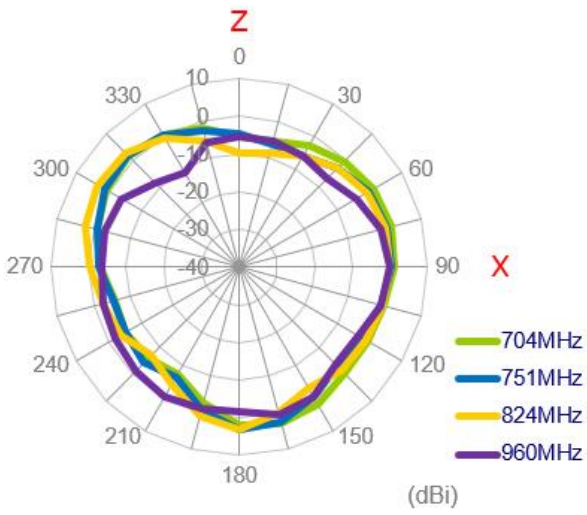

YZ Plane

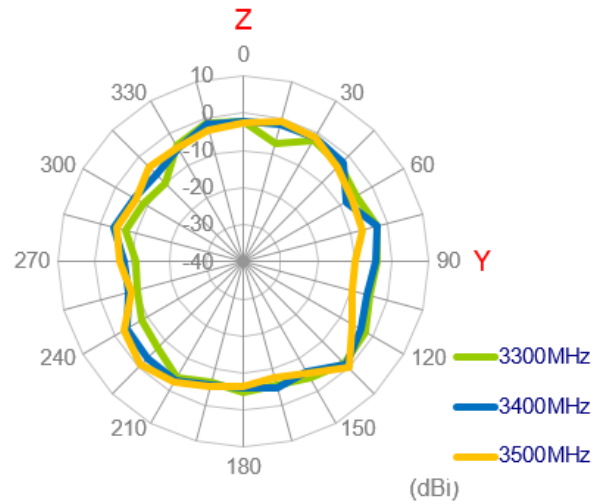
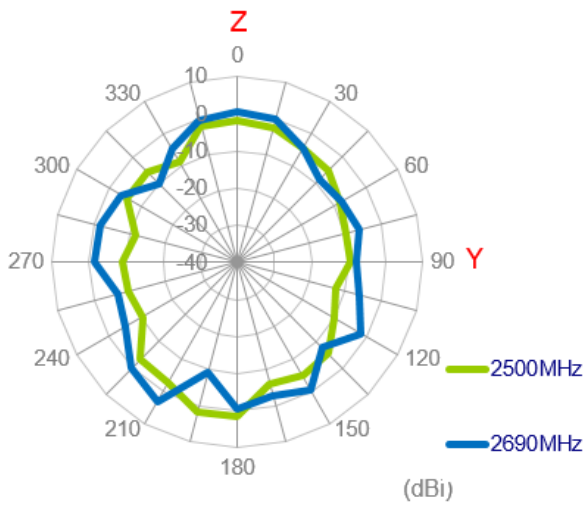
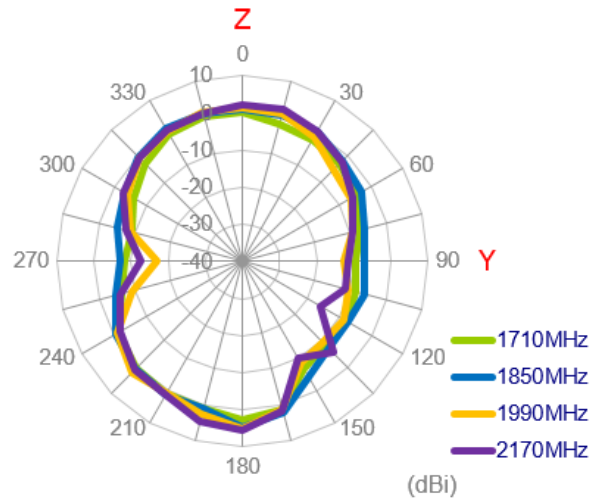
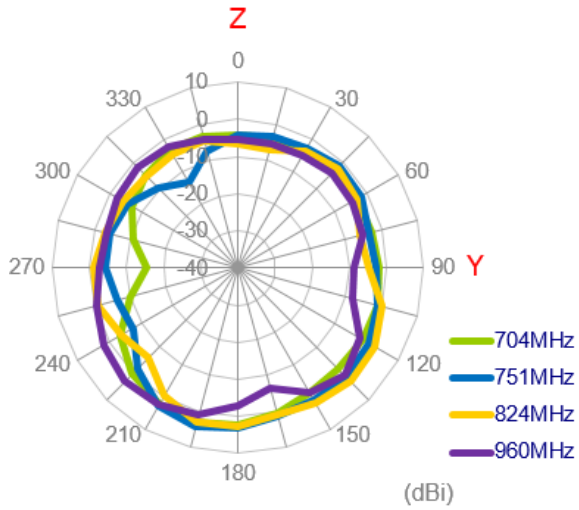

3.3.30 3D Radiation Pattern (LTE_MIMO1 with 1M cable length on ABS)

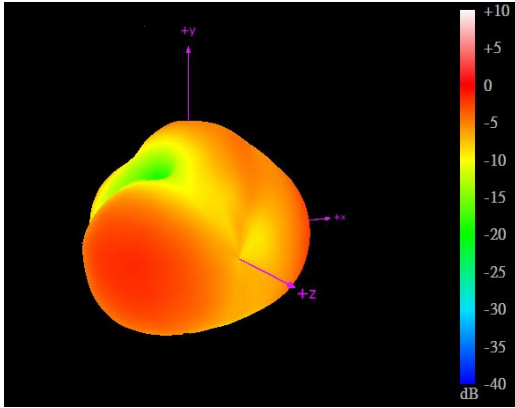

704MHz

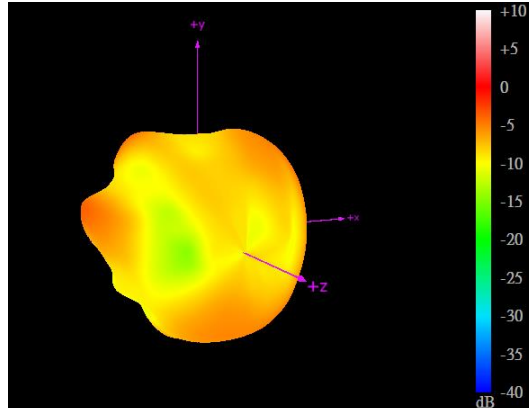

960MHz

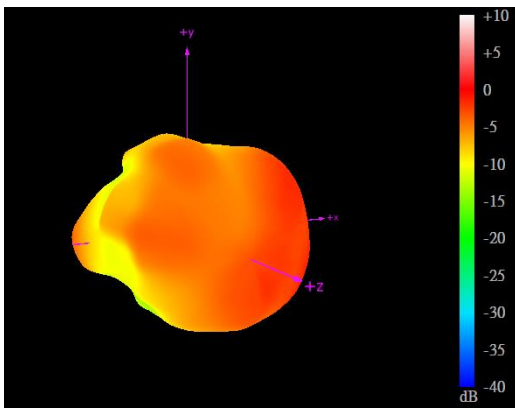

1710MHz

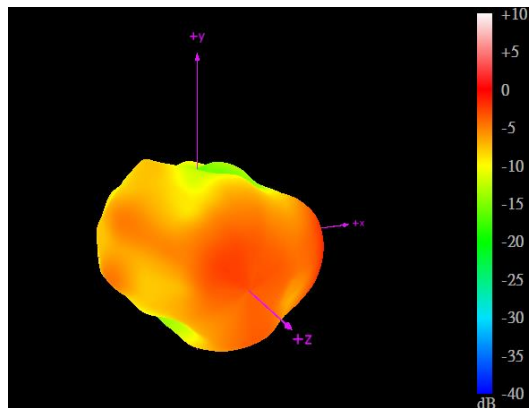

2170MHz

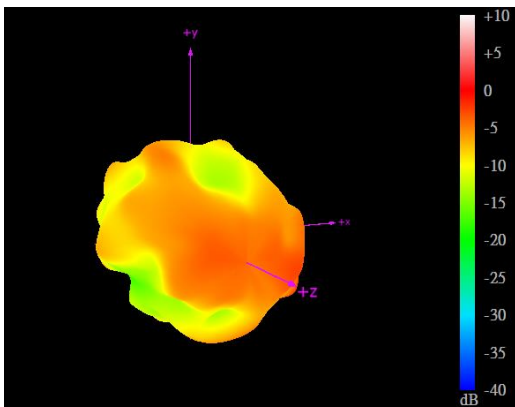

2690MHz

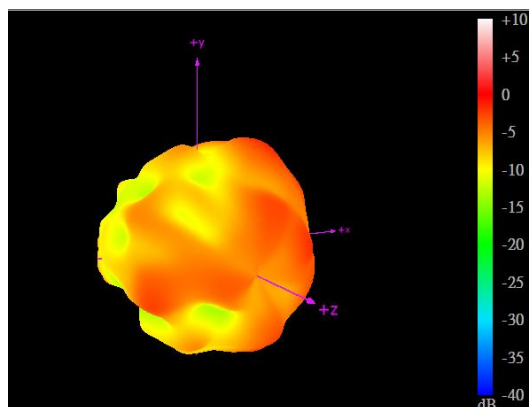

3500MHz

3.3.31 2D Radiation Pattern (LTE_MIMO2 with 1M cable length on ABS)

XY Plane

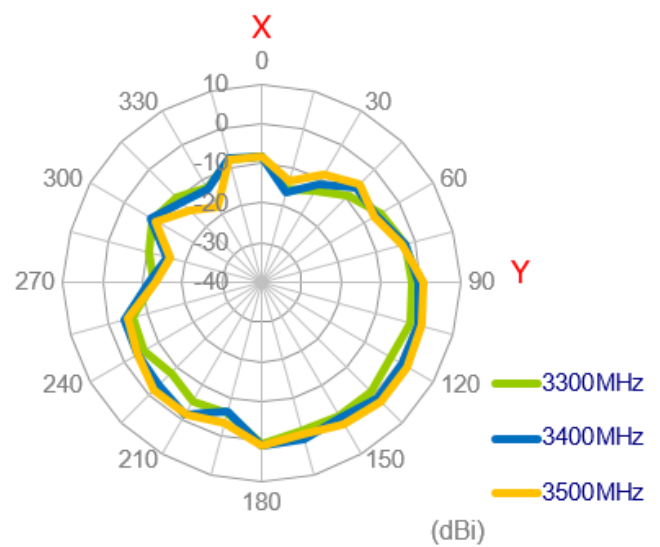
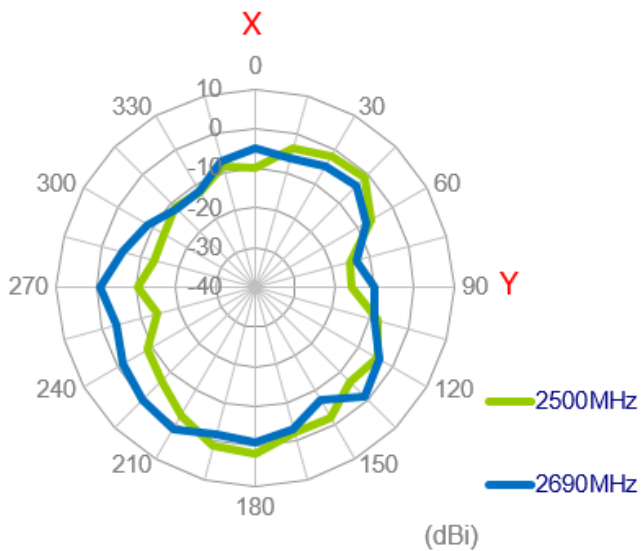
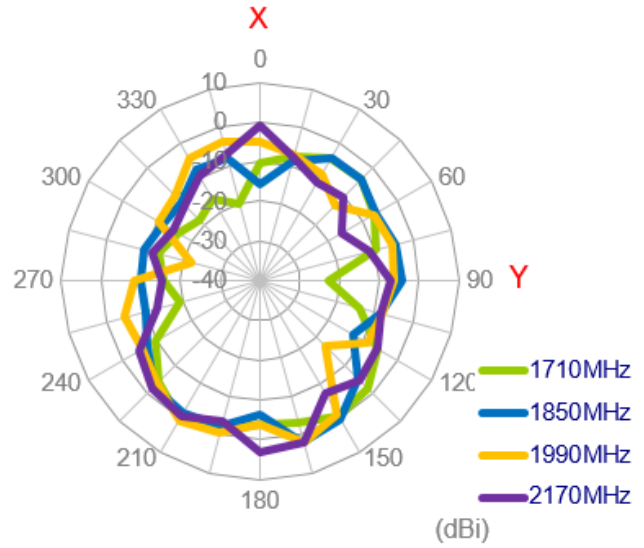
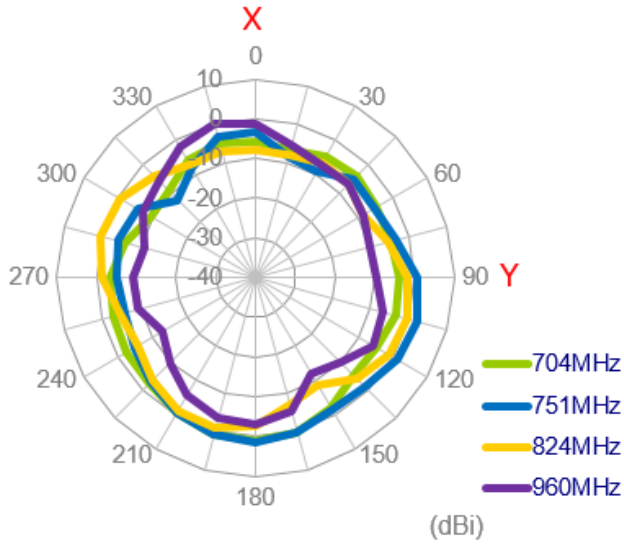

XZ Plane

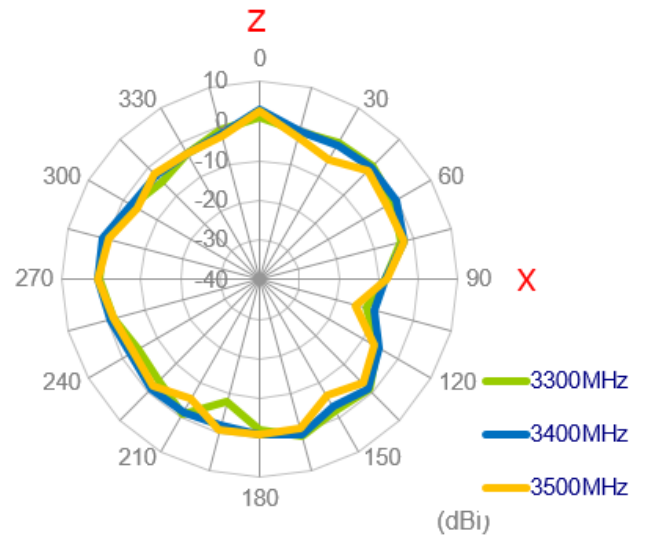
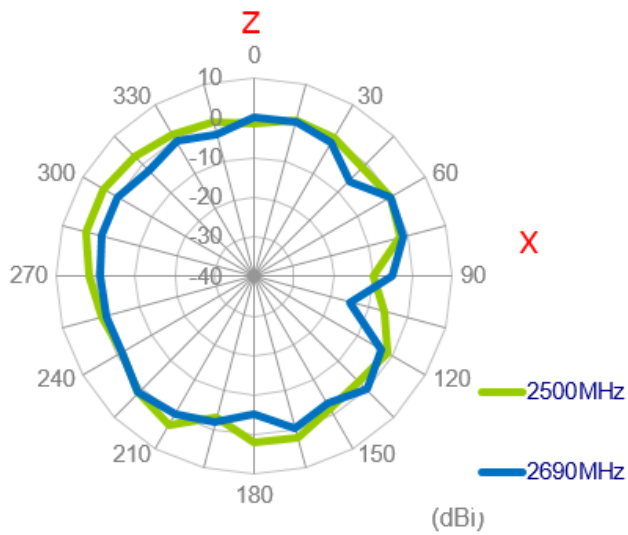
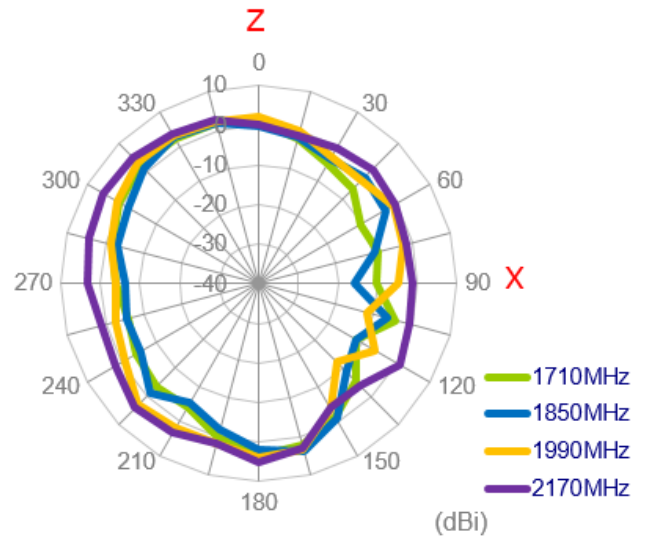
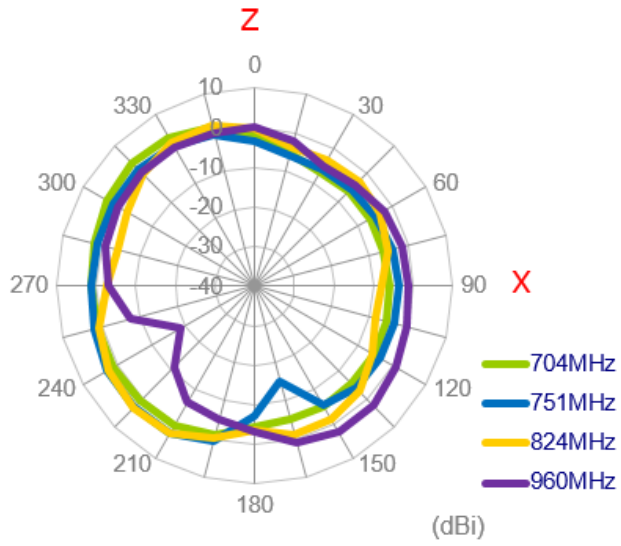

YZ Plane

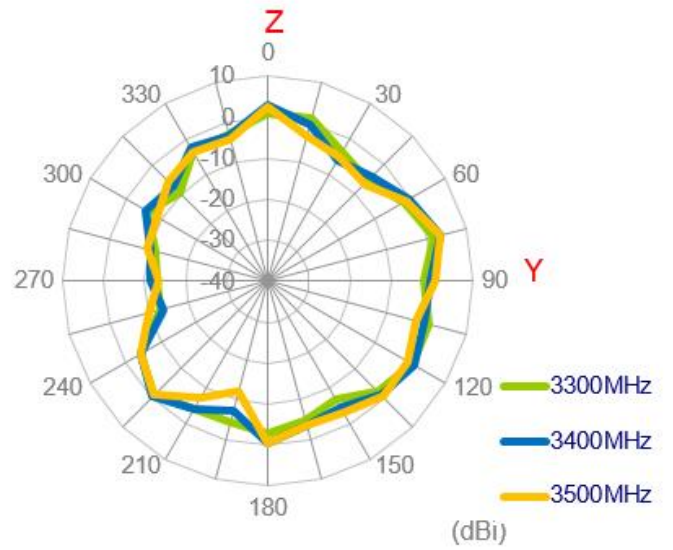
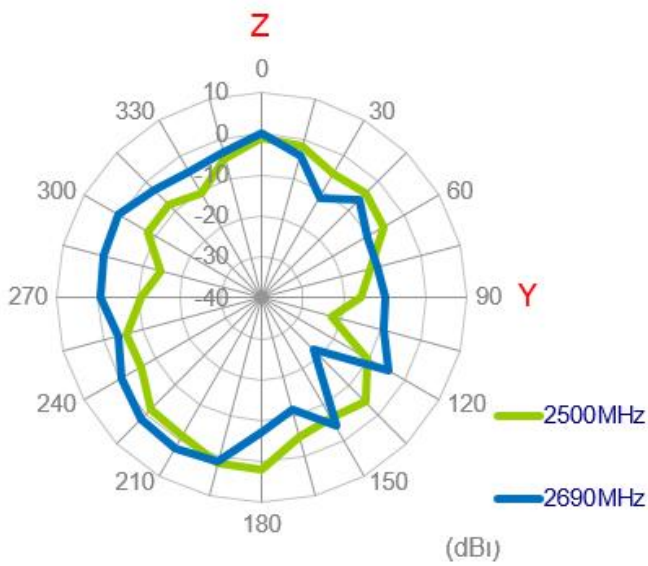
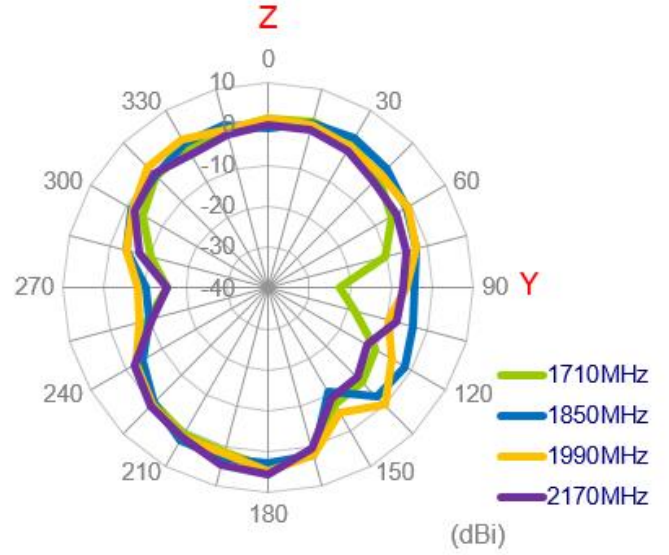
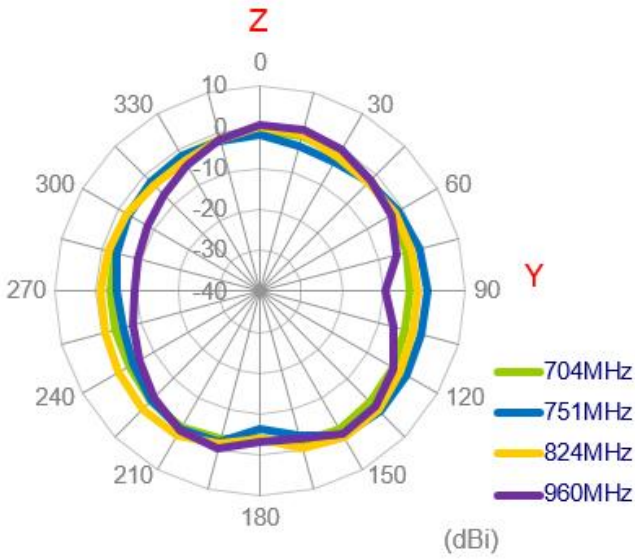

3.3.32 3D Radiation Pattern (LTE_MIMO2 with 1M cable length on ABS)

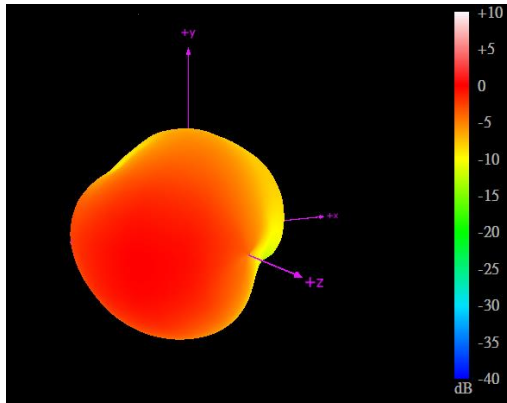

704MHz

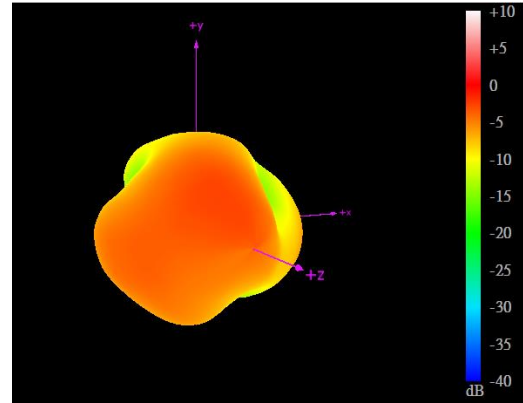

960MHz

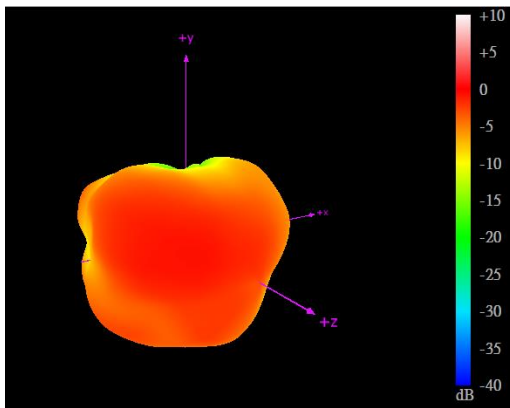

1710MHz

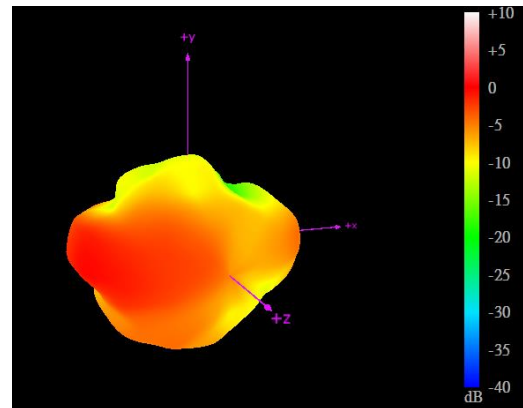

2170MHz

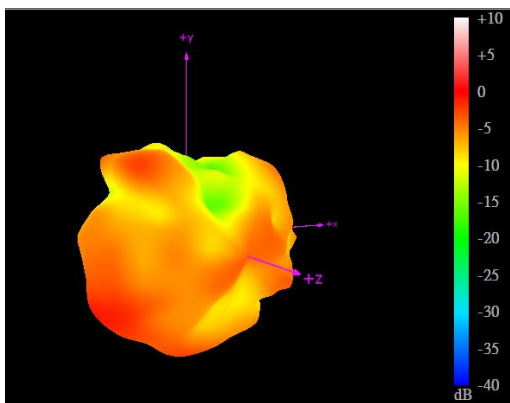

2690MHz

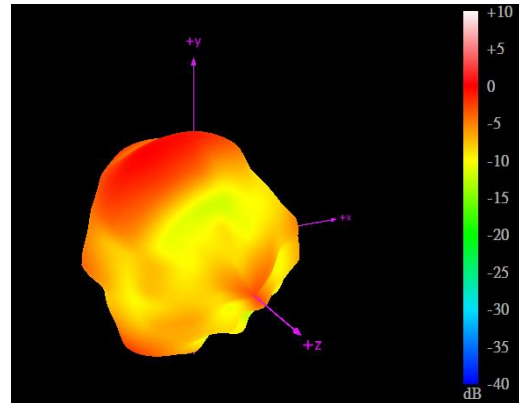

3500MHz

3.3.33 2D Radiation Pattern (Wi-Fi_MIMO1 with 1M cable length on ABS)

XY Plane

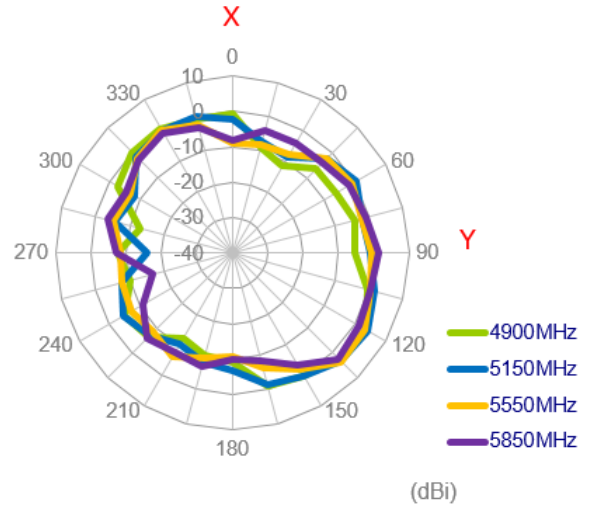
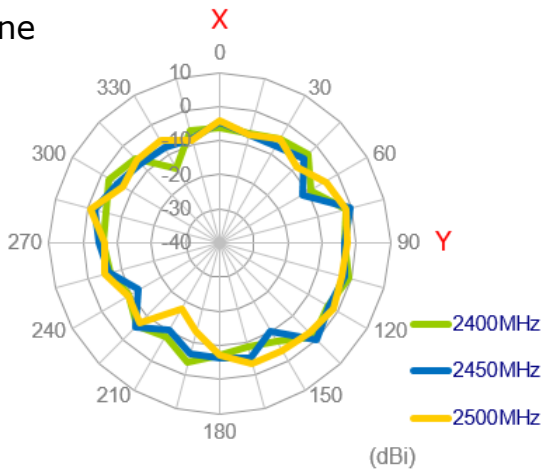

XZ Plane

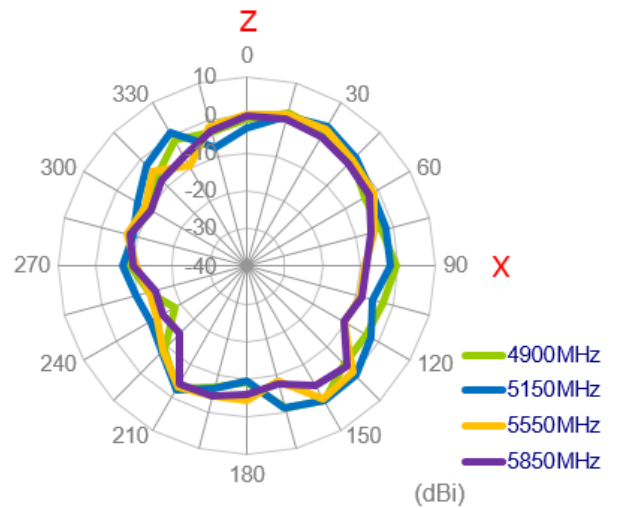
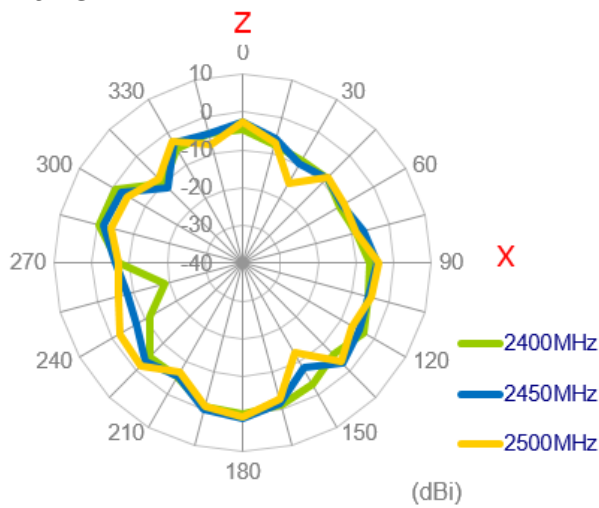

YZ Plane

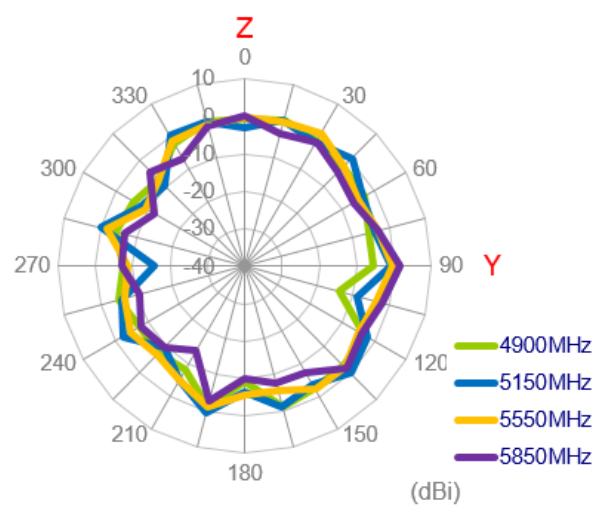
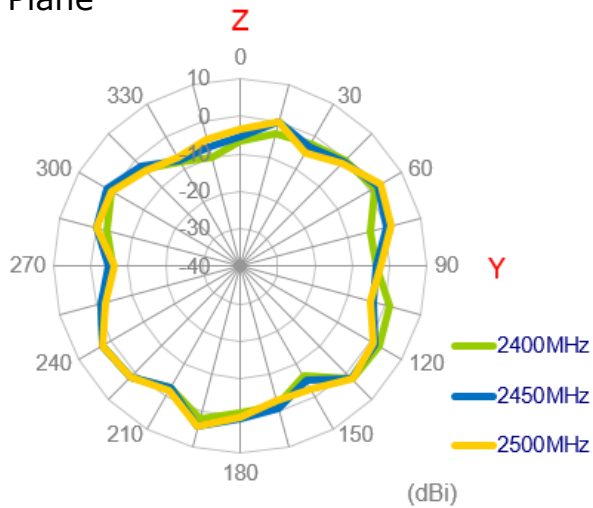

3.3.34 3D Radiation Pattern (Wi-Fi_MIMO1 with 1M cable length on ABS)

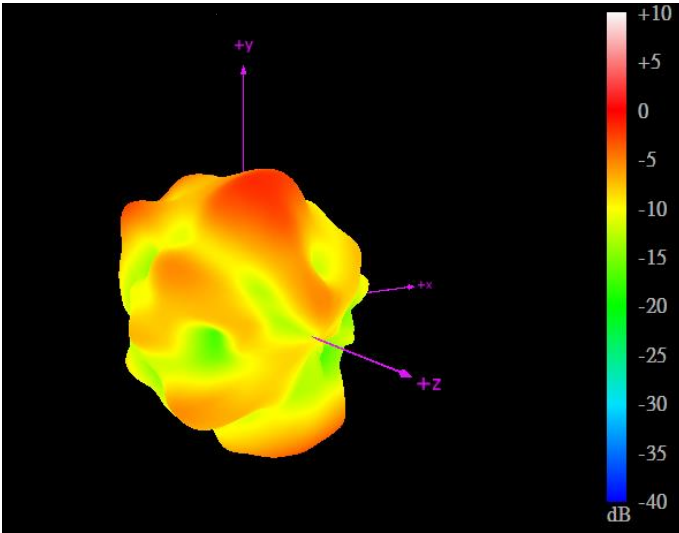

2450MHz

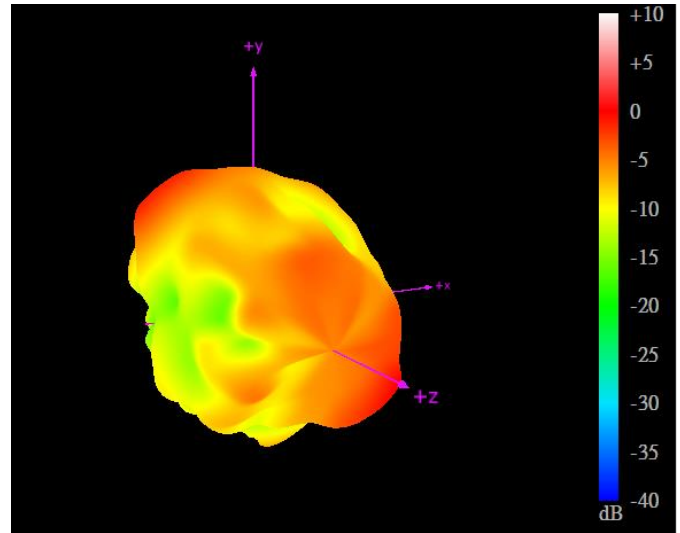

5550MHz

3.3.35 2D Radiation Pattern (Wi-Fi_MIMO2 with 3M cable length on ABS)

XY Plane

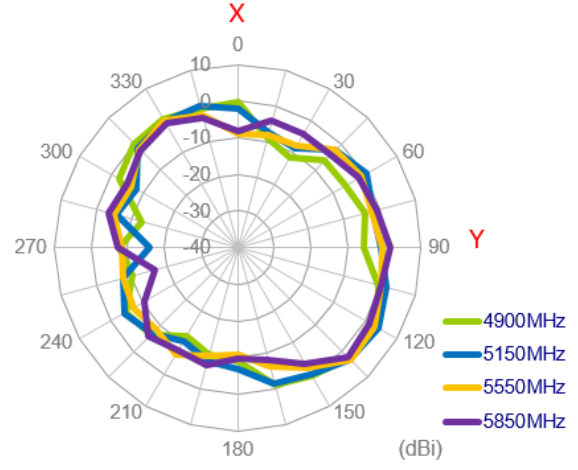
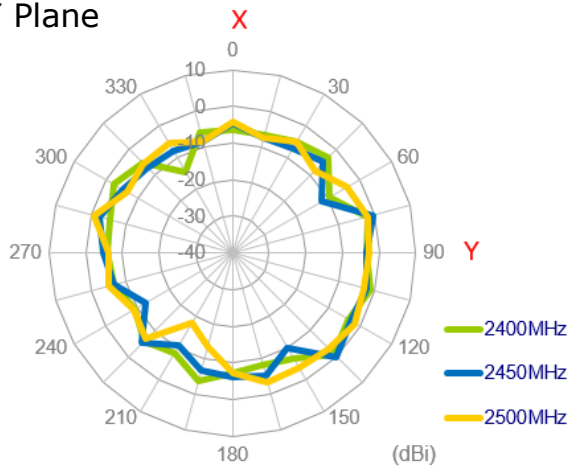

XZ Plane

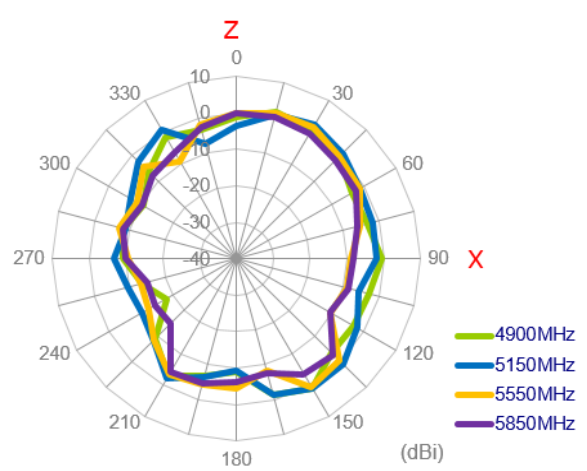
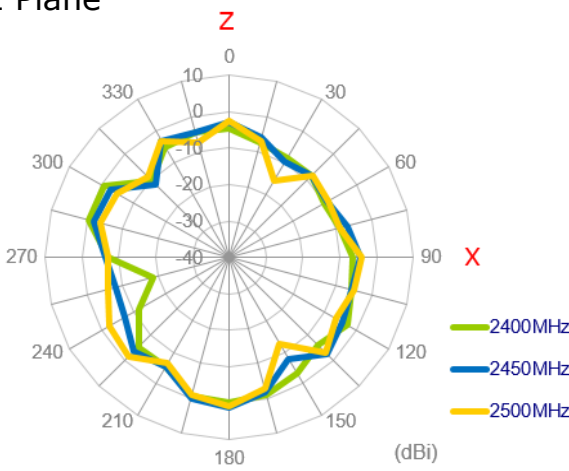

YZ Plane

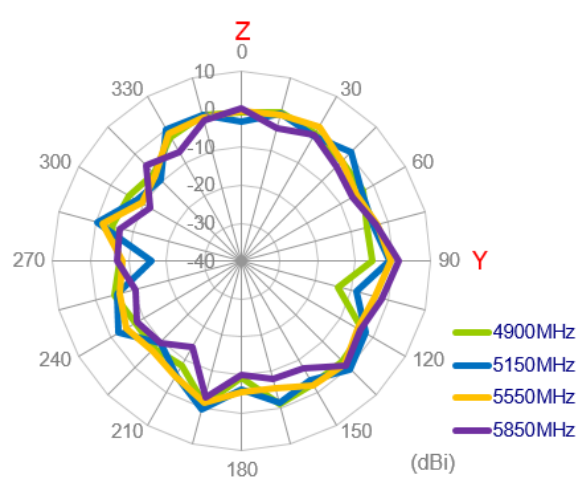
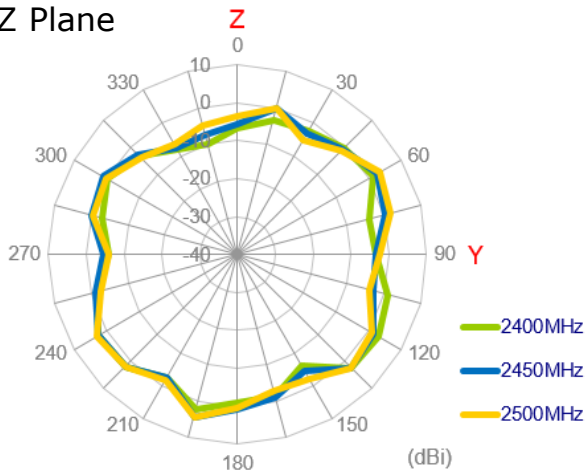

3.3.36 3D Radiation Pattern (Wi-Fi_MIMO2 with 1M cable length on ABS)

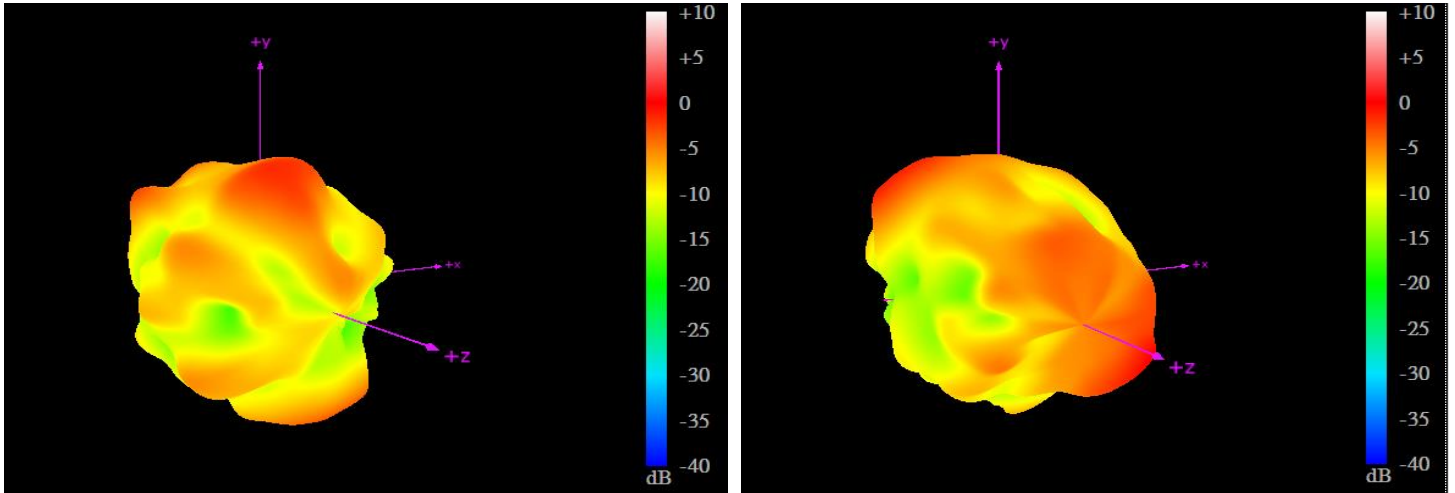

2450MHz

5550MHz

3.3.37 Test Setup for Antenna Radiation Pattern



On glass

3.3.38 2D Radiation Pattern (LTE_MIMO1 with 1M cable length on glass)

XY Plane

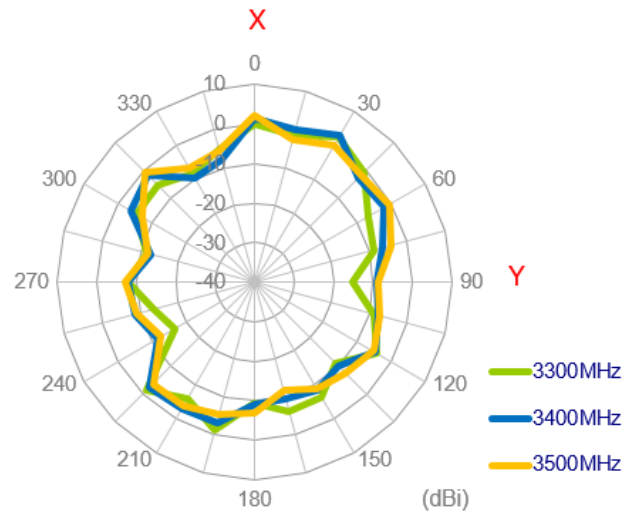
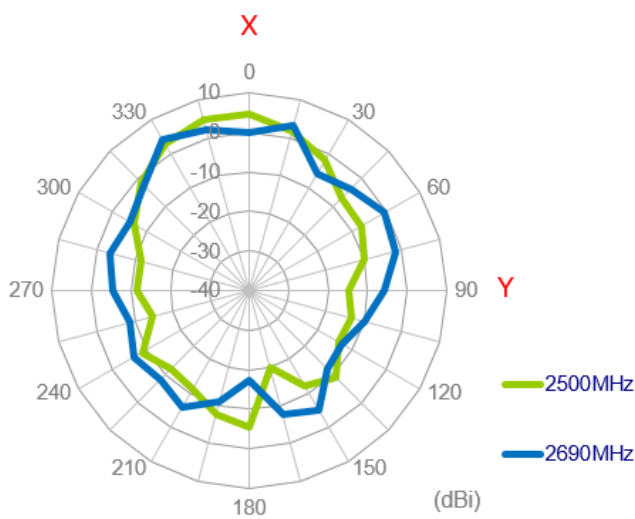
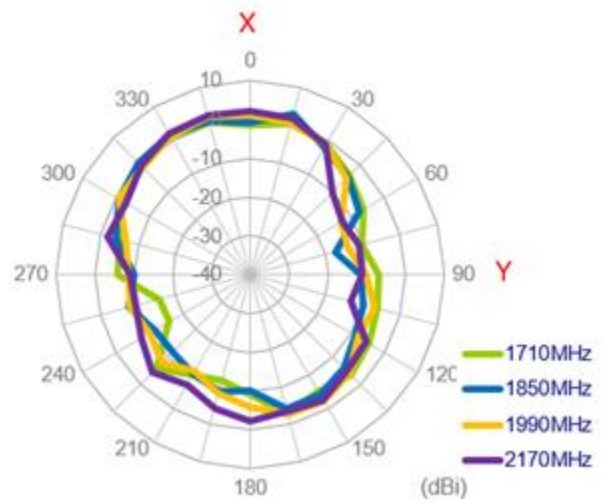
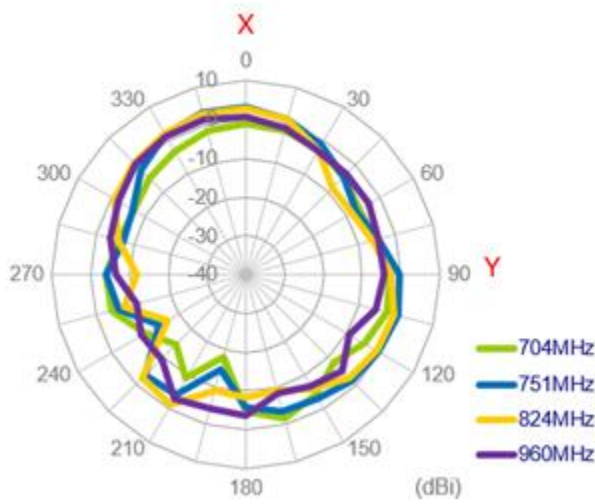

XZ Plane

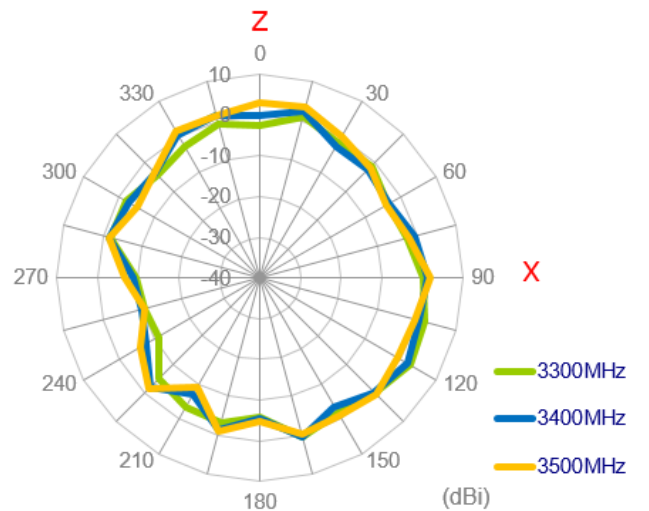
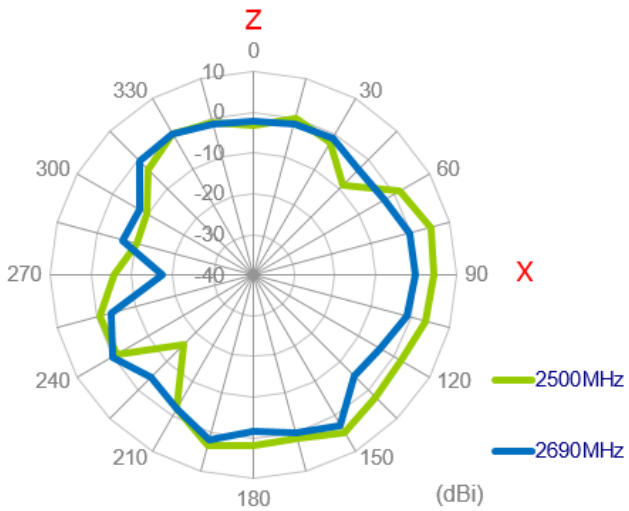
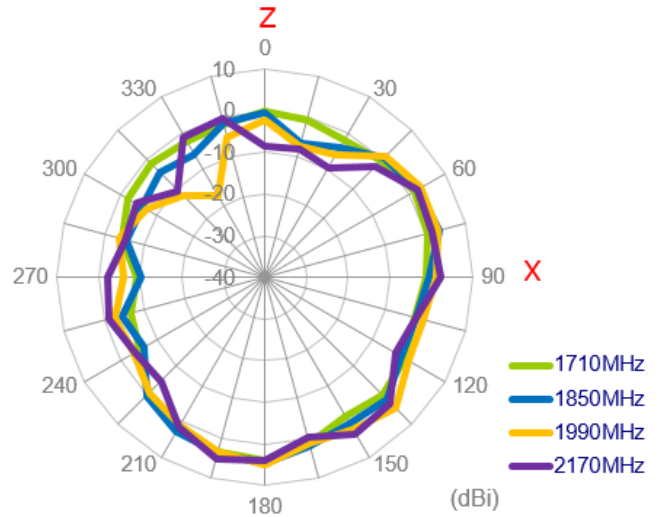
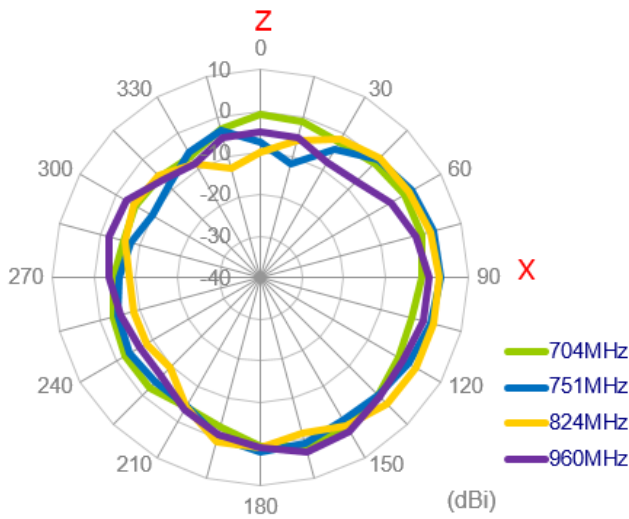

YZ Plane

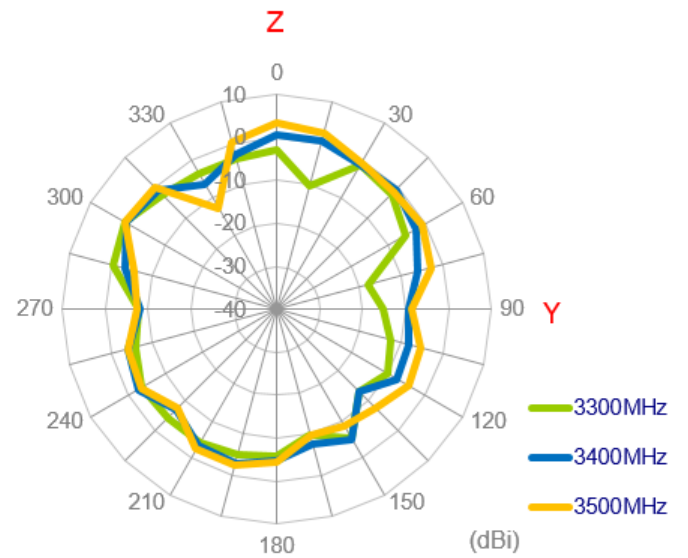
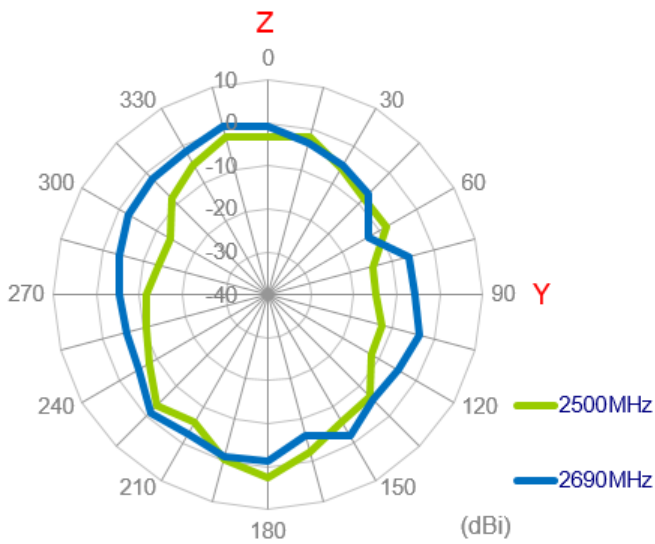
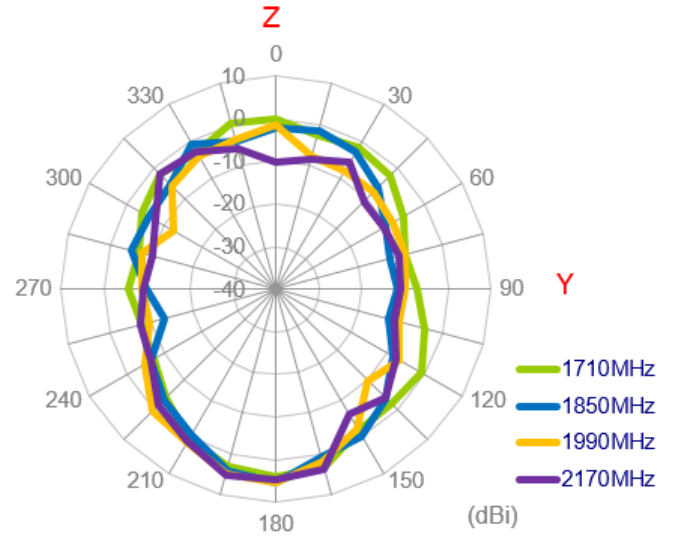
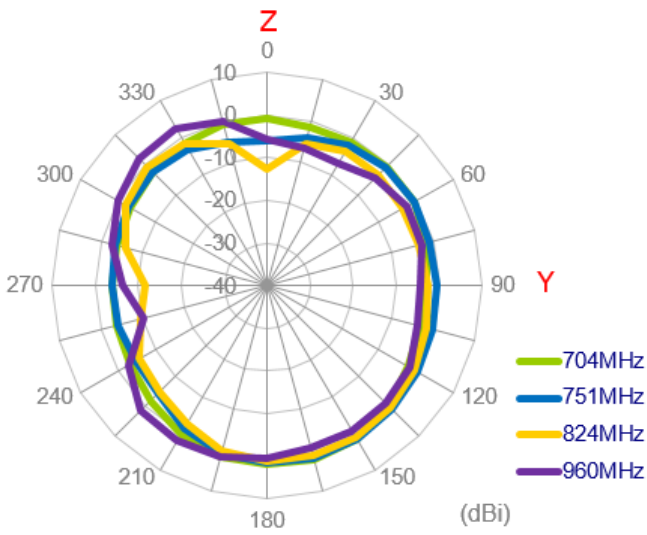

3.3.39 3D Radiation Pattern (LTE_MIMO1 with 1M cable length on glass)

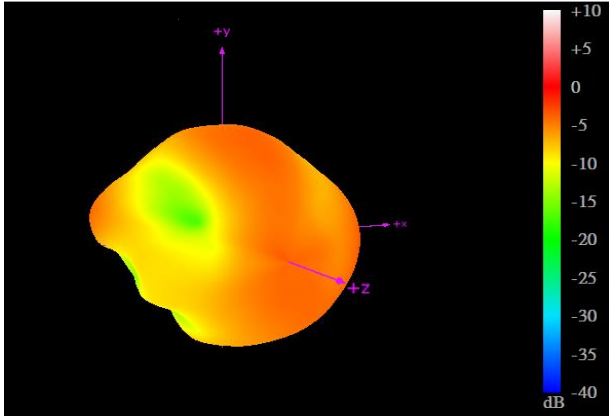

704MHz

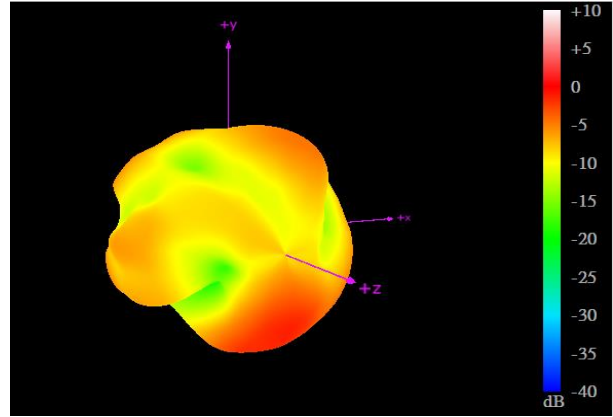

960MHz

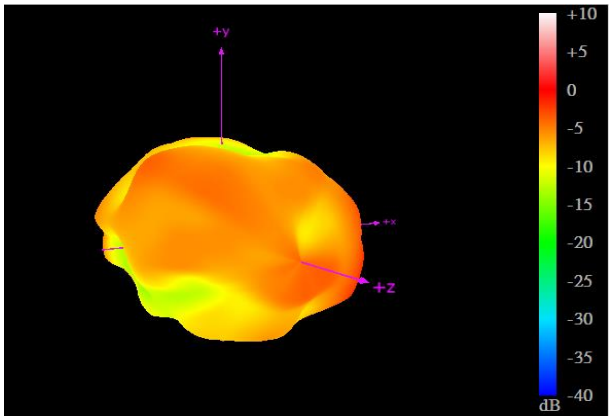

1710MHz

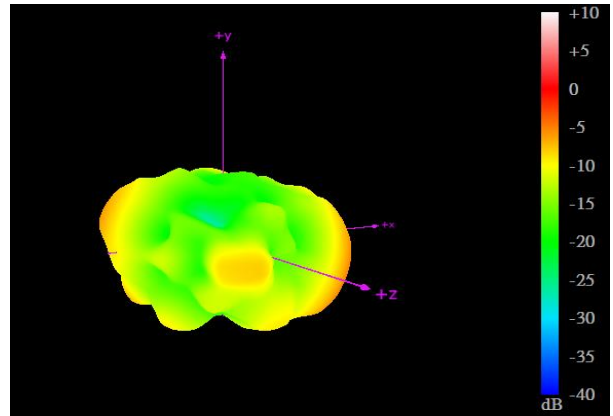

2170MHz

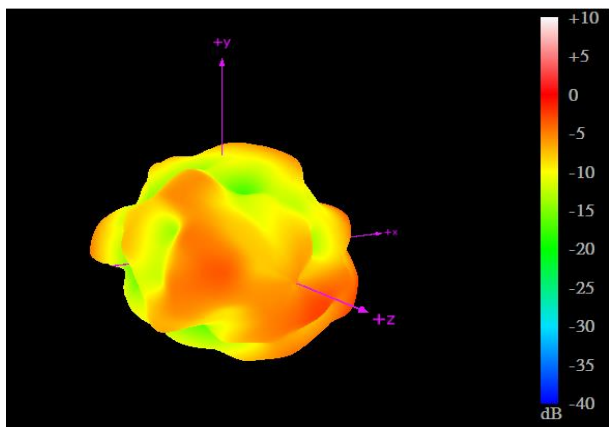

2690MHz

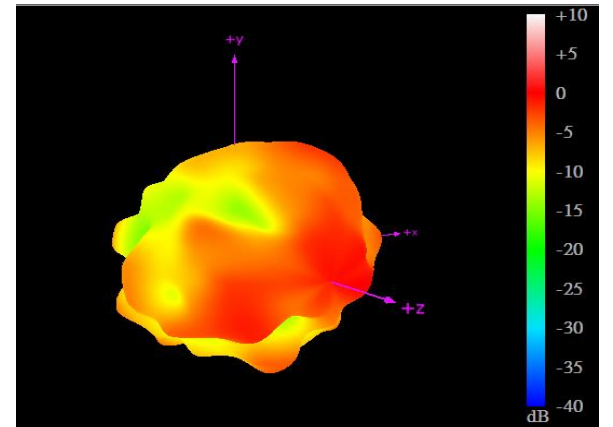

3500MHz

3.3.40 2D Radiation Pattern (LTE_MIMO2 with 1M cable length on glass)

XY Plane

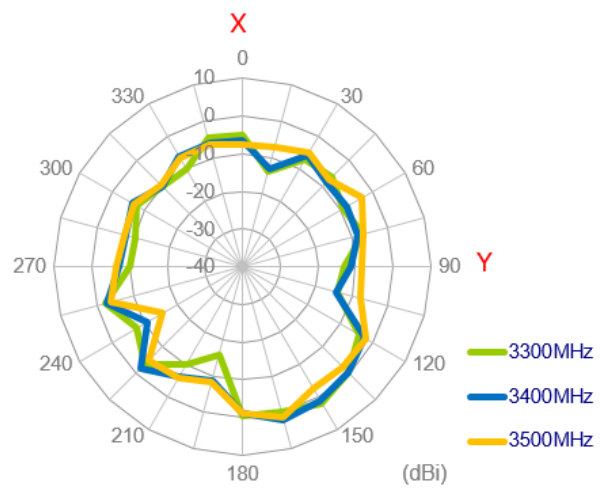
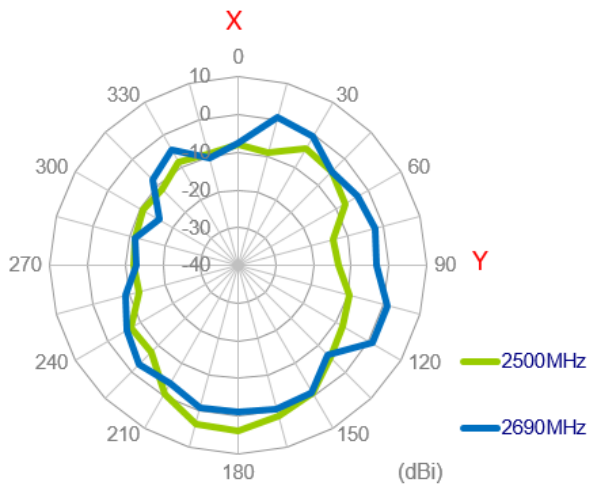
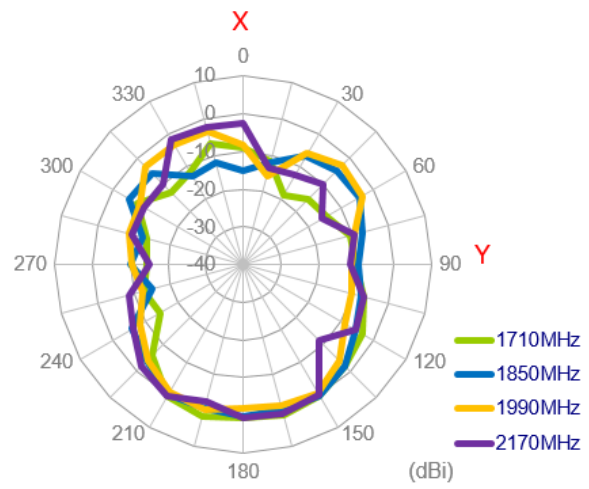
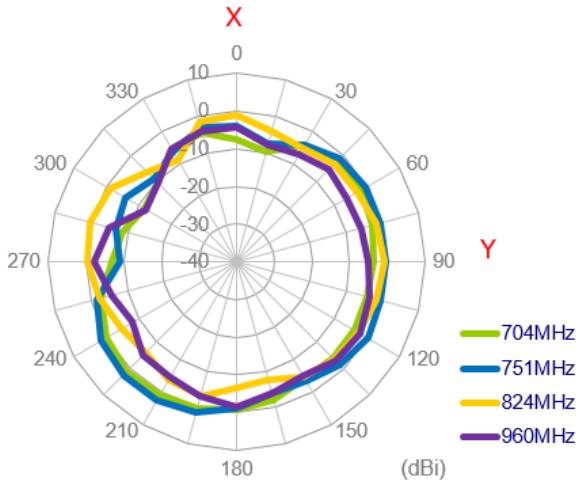

XZ Plane

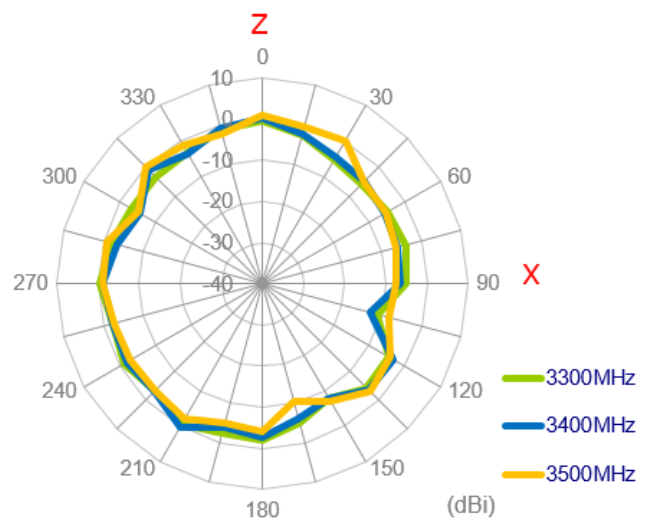
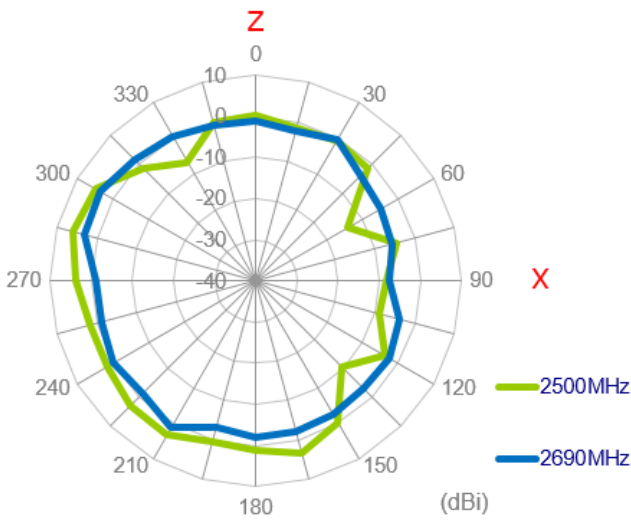
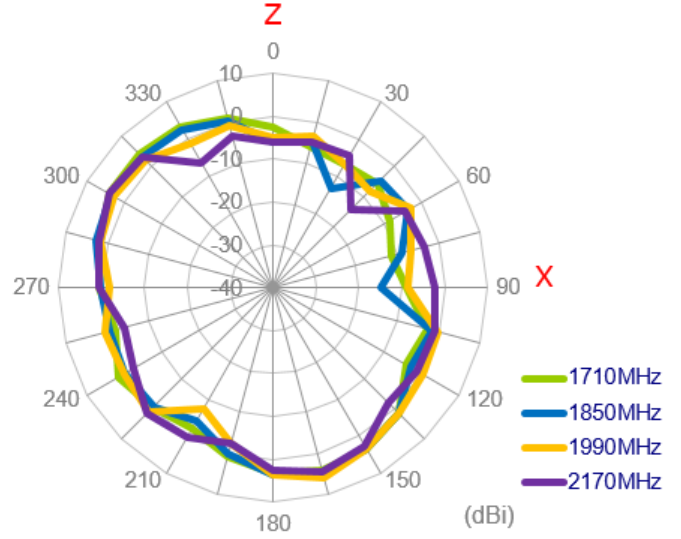
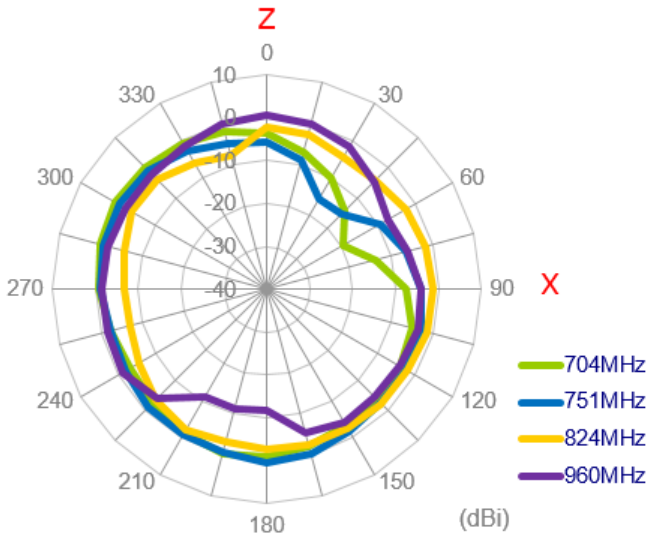

YZ Plane

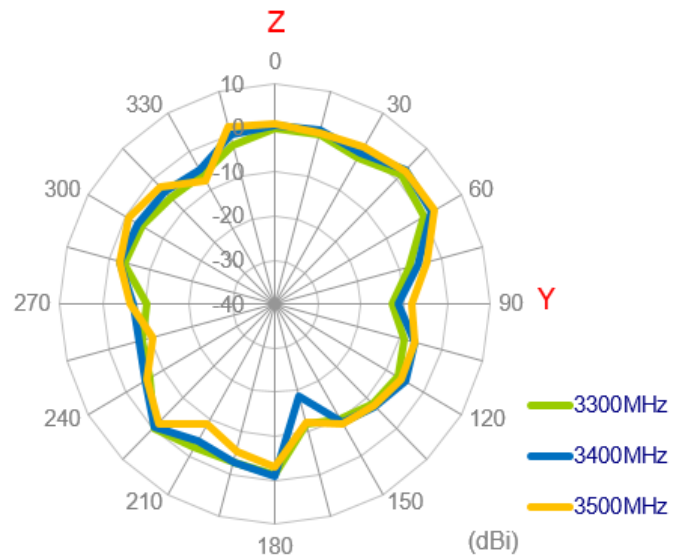
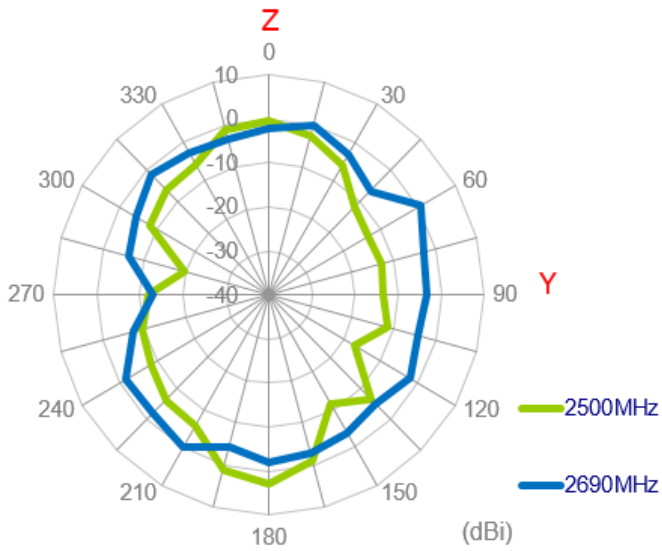
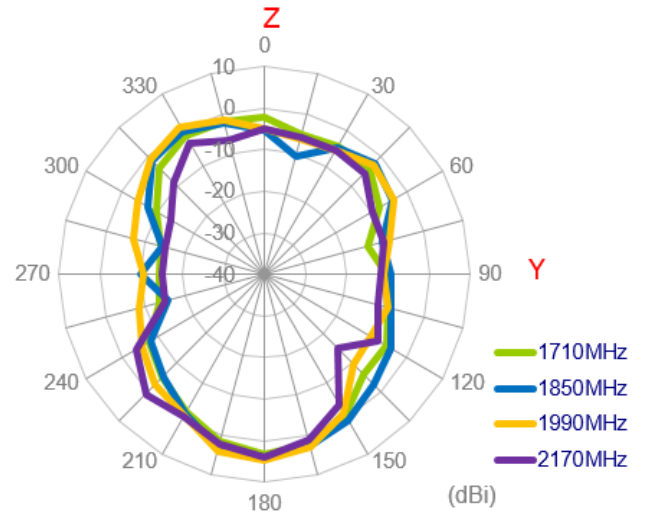
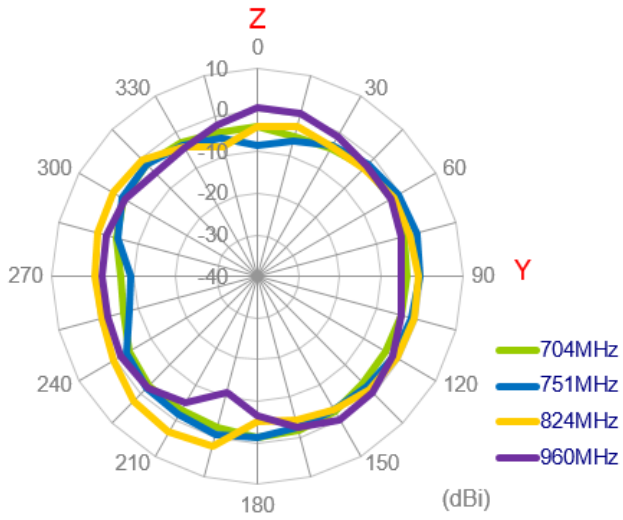

3.3.41 3D Radiation Pattern (LTE_MIMO2 with 1M cable length on glass)

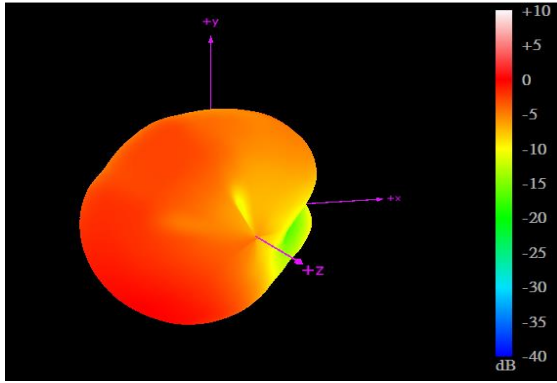

704MHz

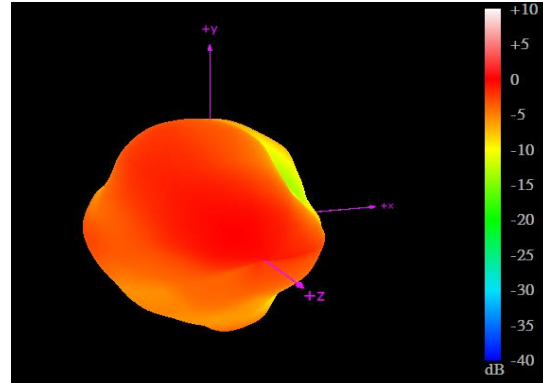

960MHz

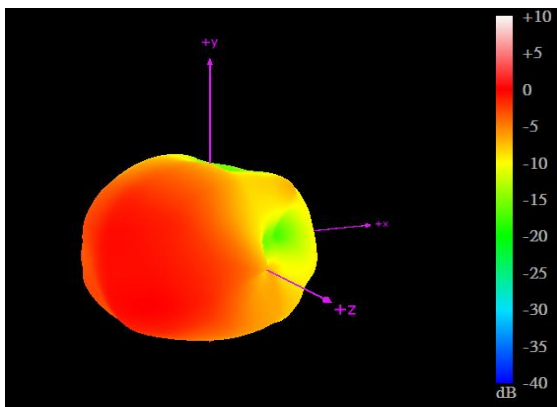

1710MHz

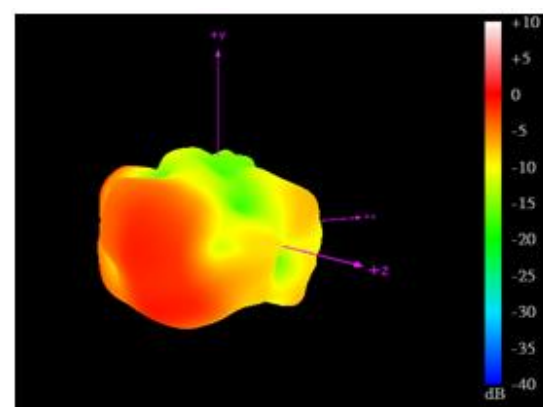

2170MHz

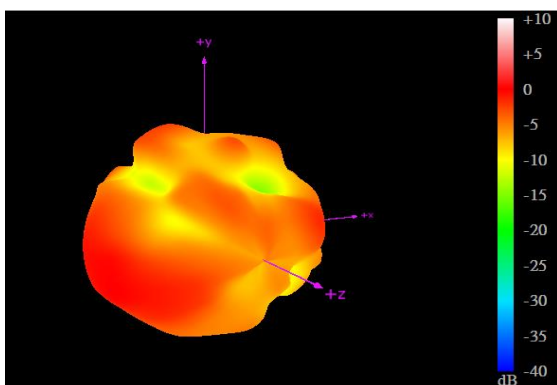

2690MHz

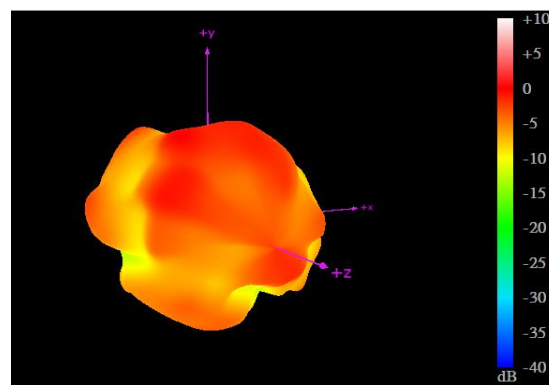

3500MHz

3.3.42 2D Radiation Pattern (Wi-Fi_MIMO1 with 1M cable length on glass)

XY Plane

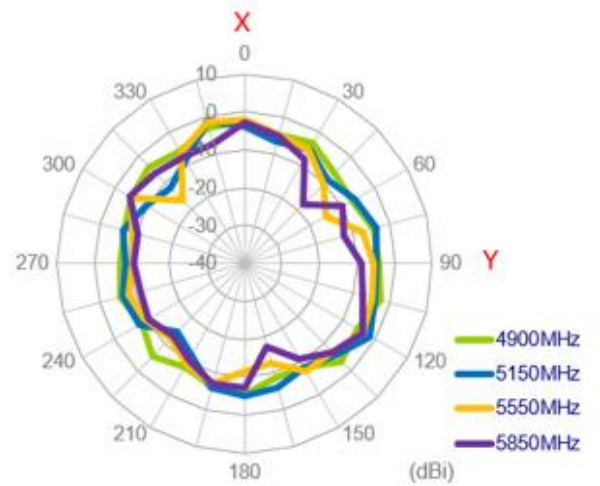
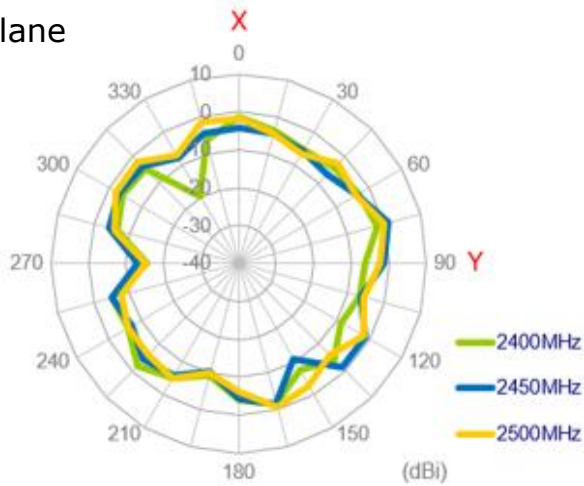

XZ Plane

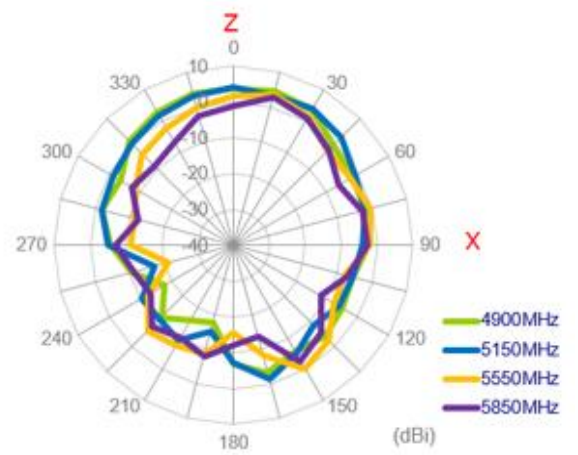
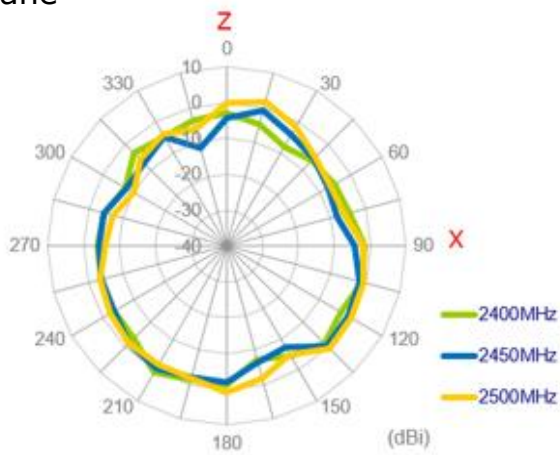

YZ Plane

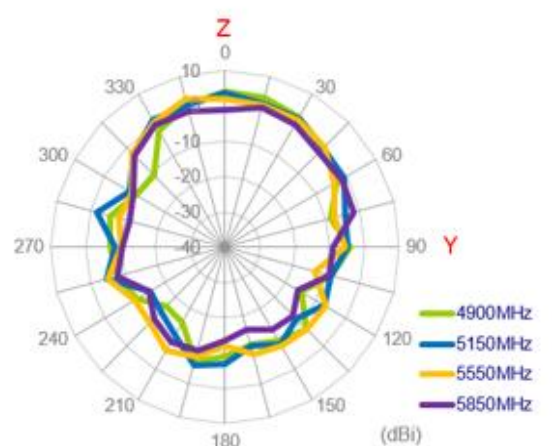
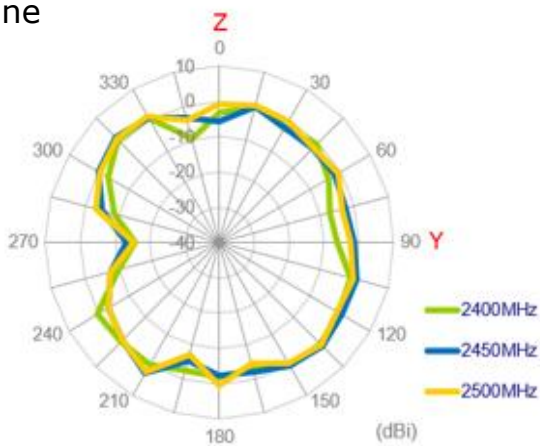

3.3.43 3D Radiation Pattern (Wi-Fi_MIMO1 with 1M cable length on glass)

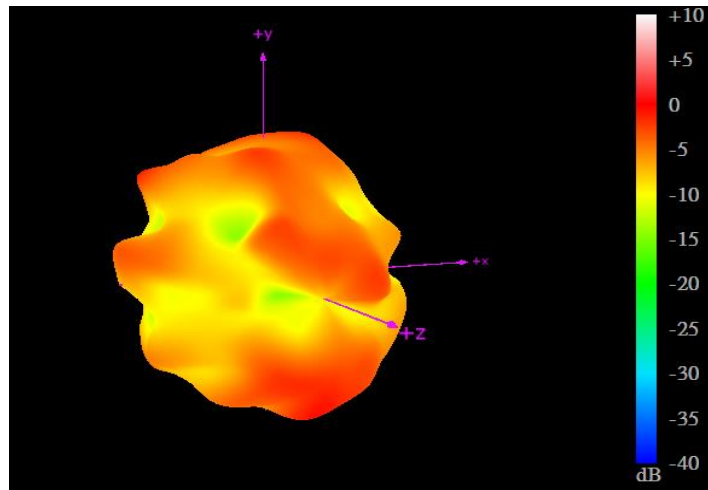

2450MHz

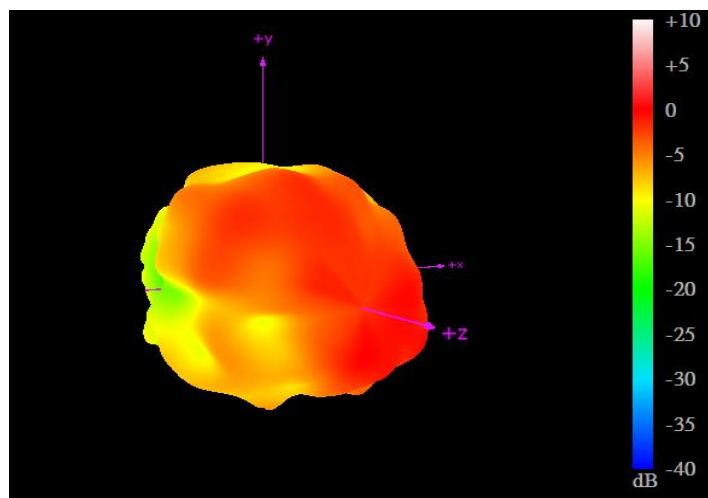

5550MHz

3.3.44 2D Radiation Pattern (Wi-Fi_MIMO2 with 3M cable length on glass)

XY Plane

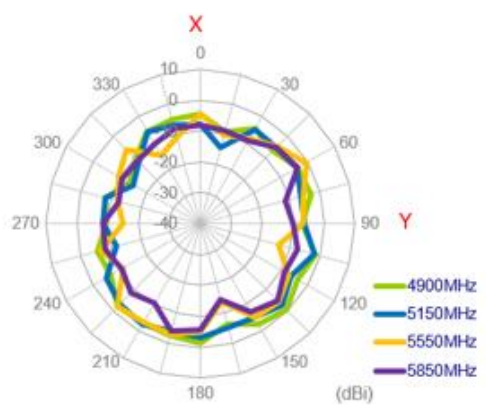
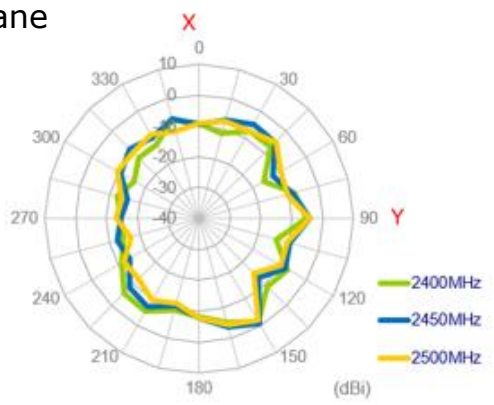

XZ Plane

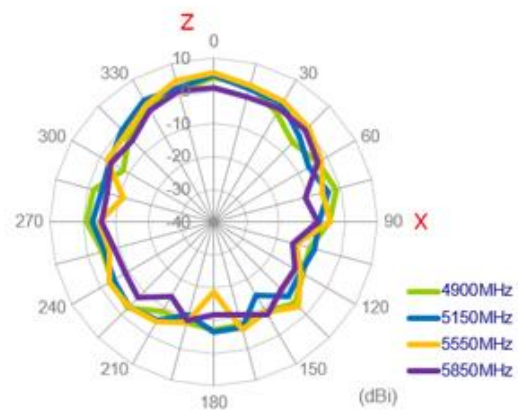
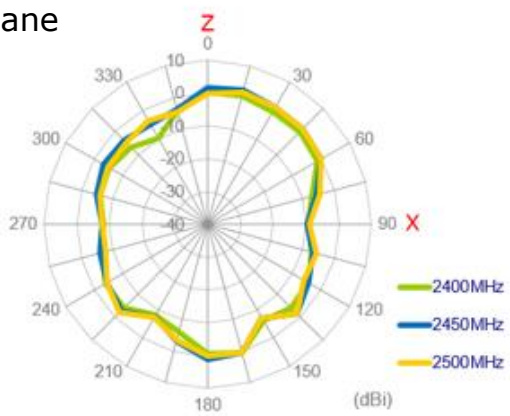

YZ Plane

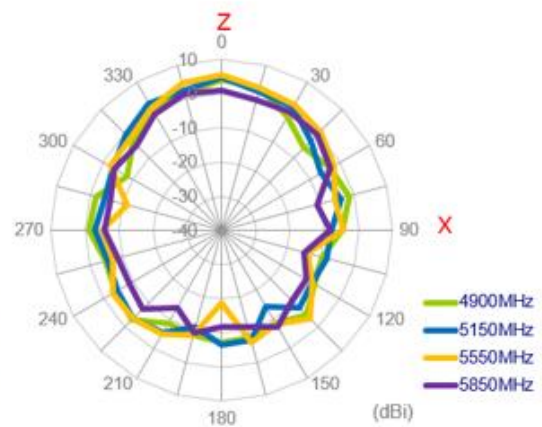
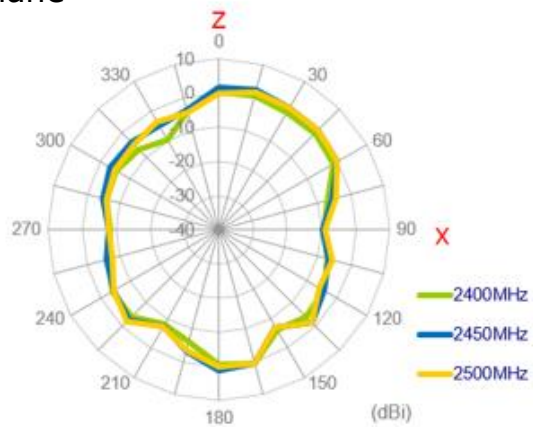

3.3.45 3D Radiation Pattern (Wi-Fi_MIMO2 with 1M cable length on glass)

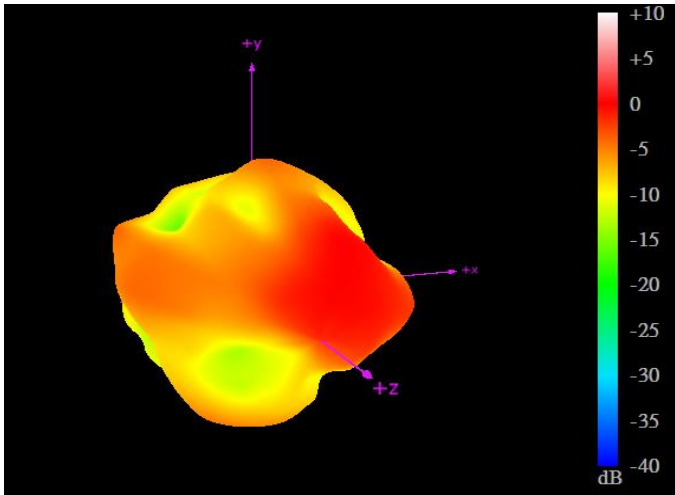

2450MHz

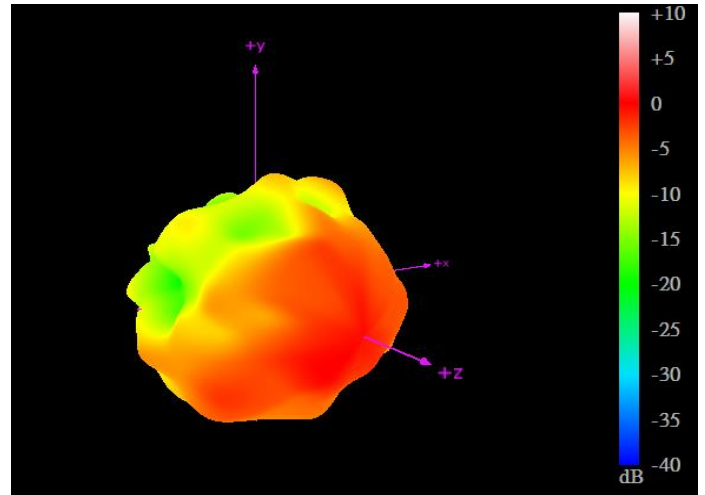

5550MHz

3.3.46 Test Setup for Antenna Radiation Pattern

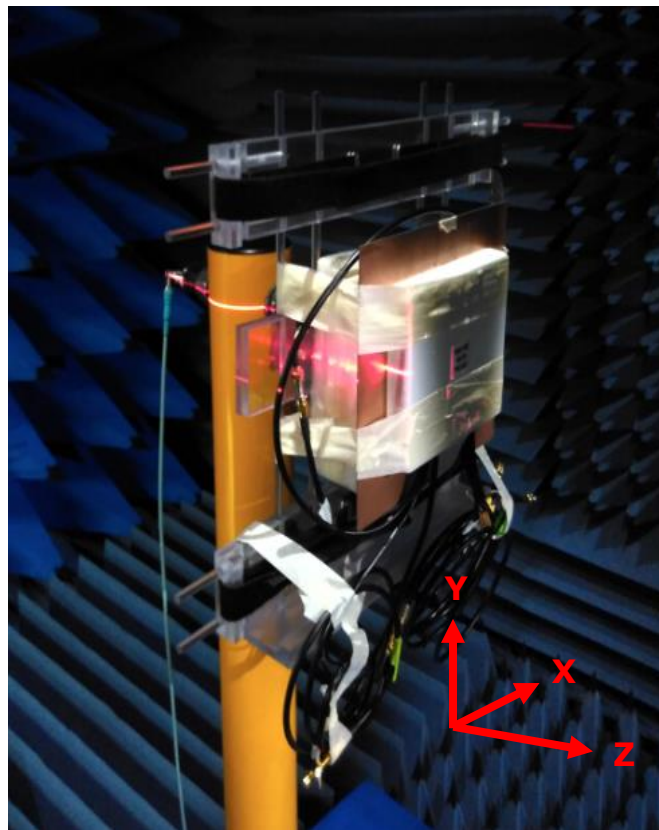

On metal

3.3.47 2D Radiation Pattern (LTE_MIMO1 with 1M cable length on metal)

XY Plane

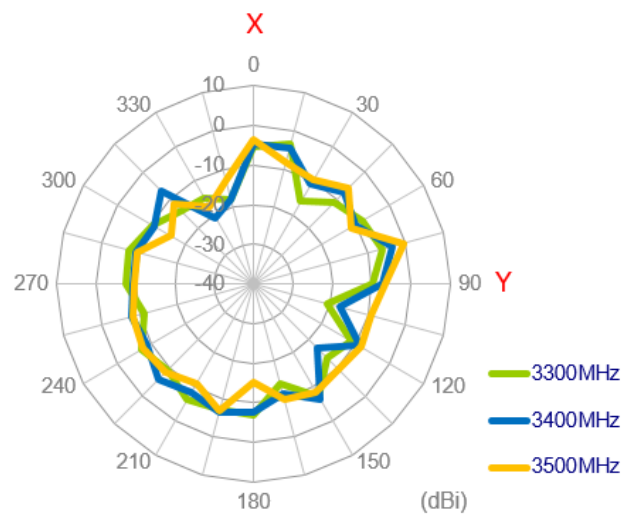
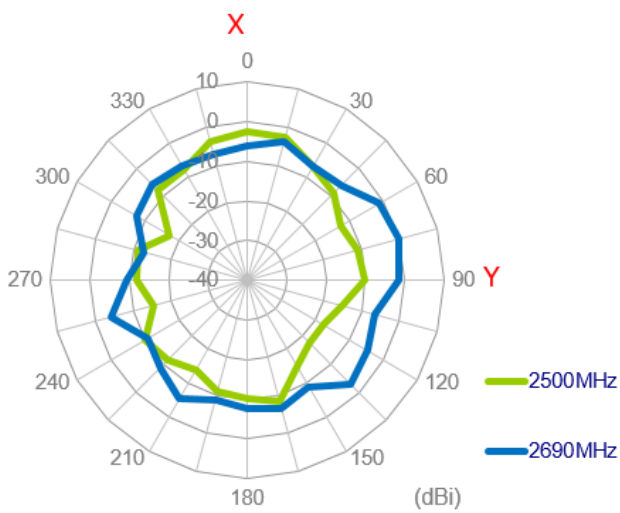
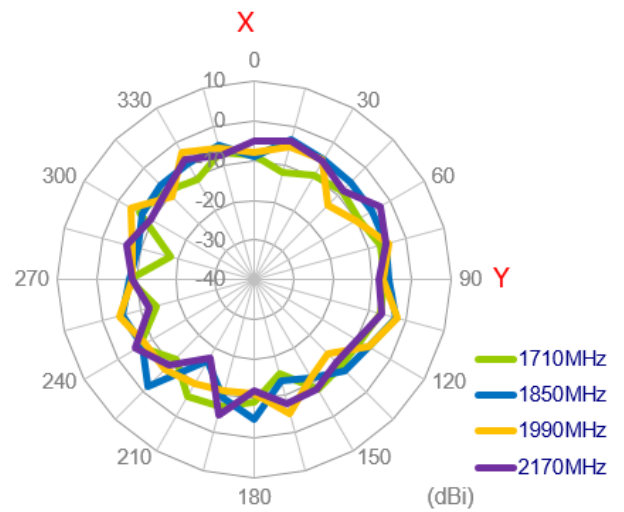
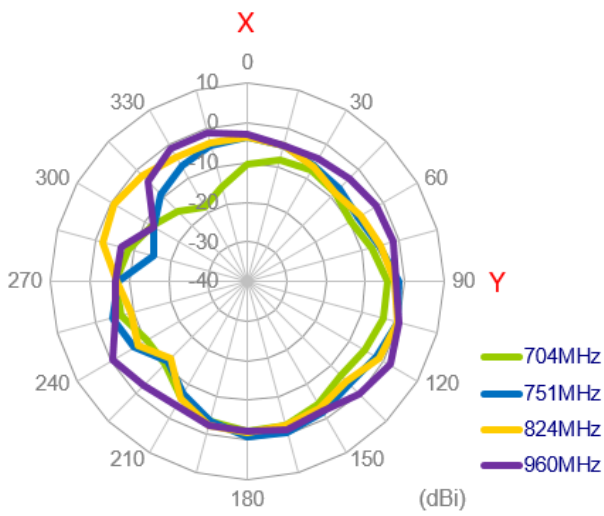

XZ Plane

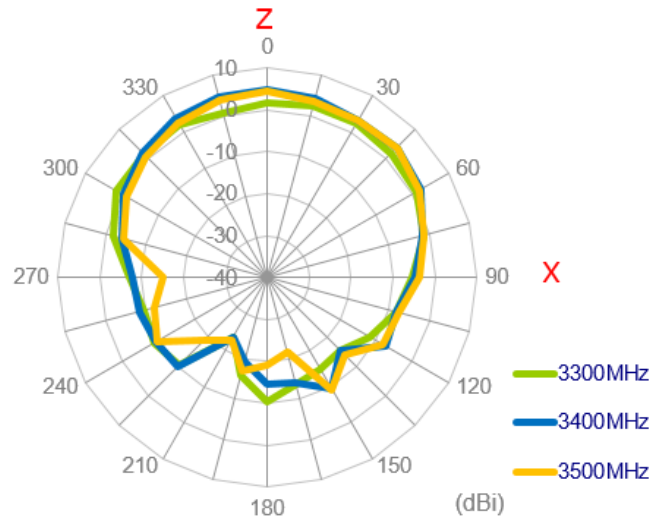
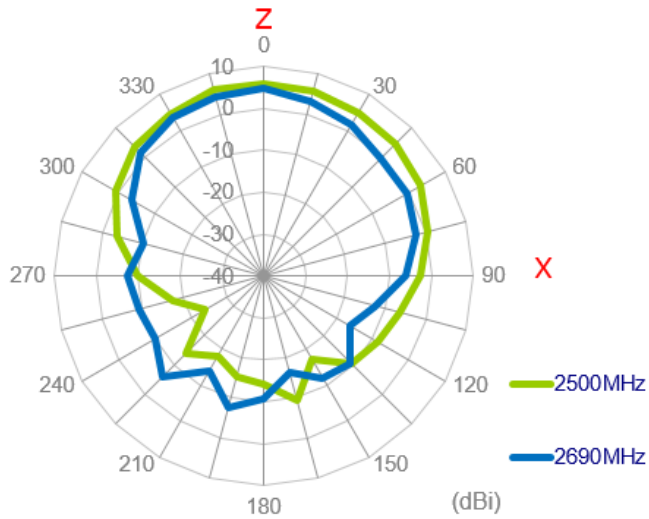
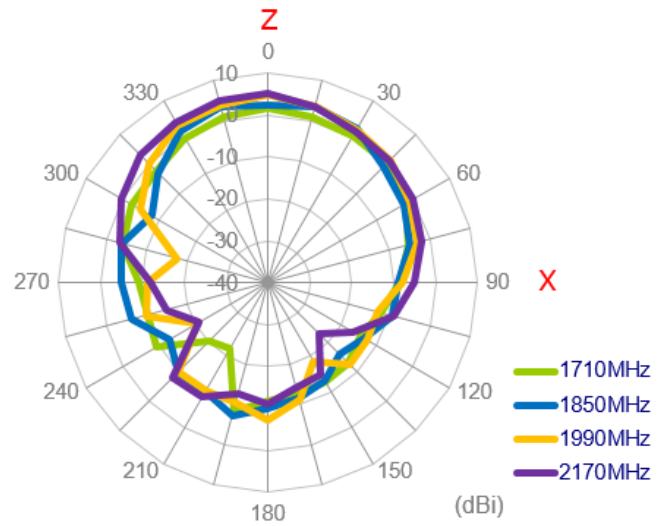
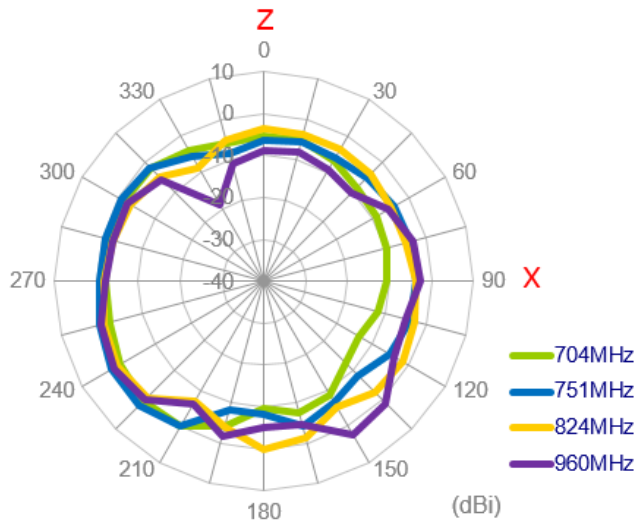

YZ Plane

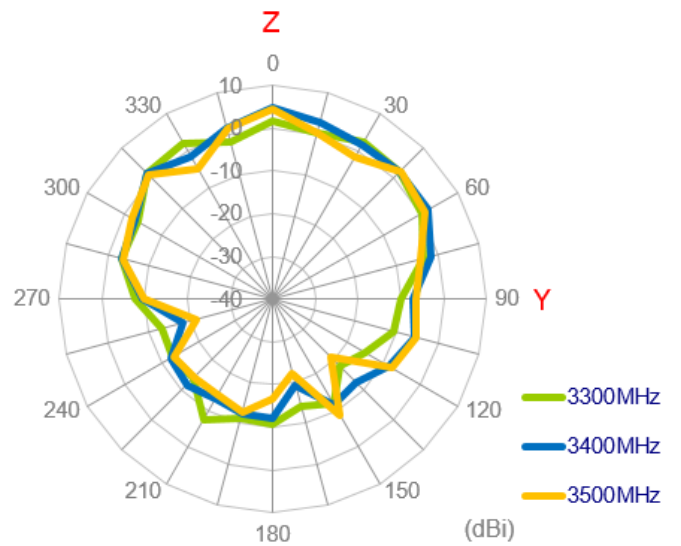
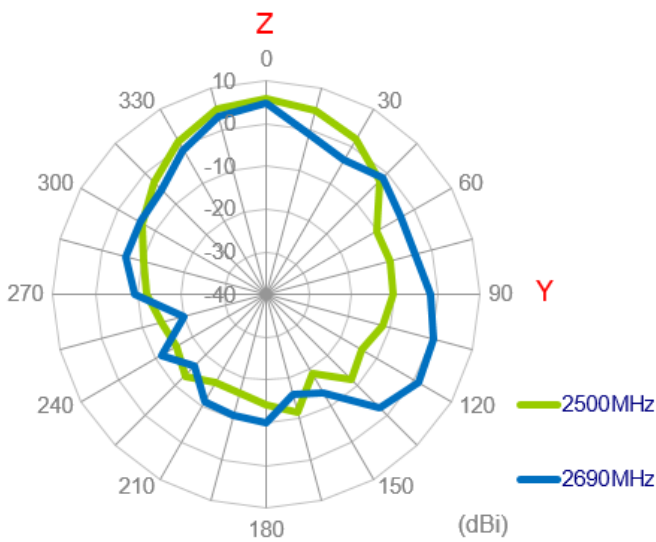
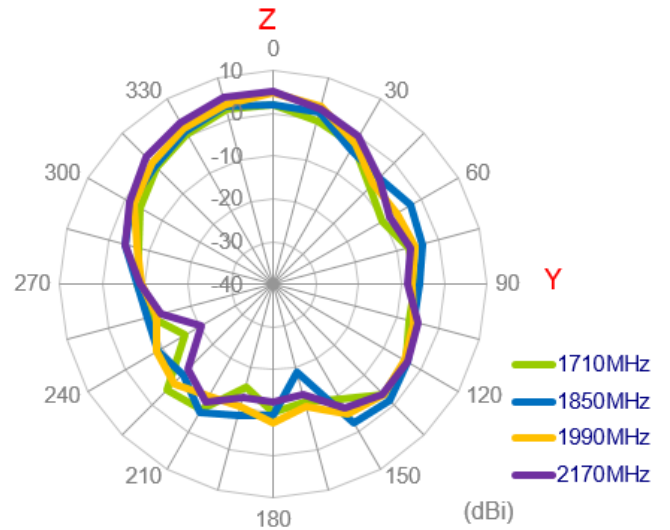
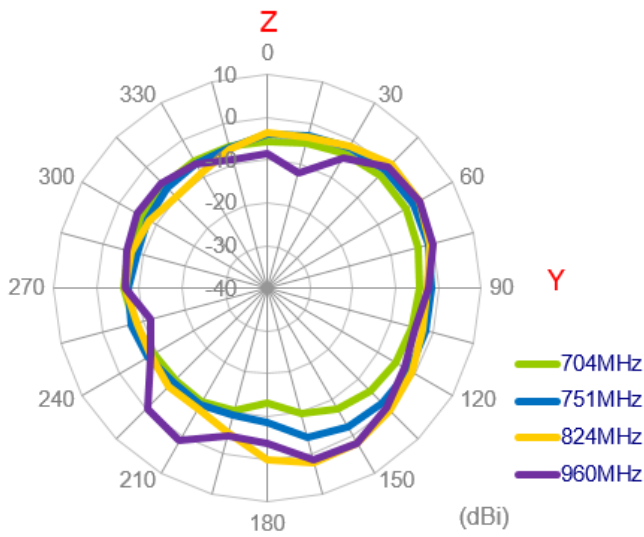

3.3.48 3D Radiation Pattern (LTE_MIMO1 with 1M cable length on metal)

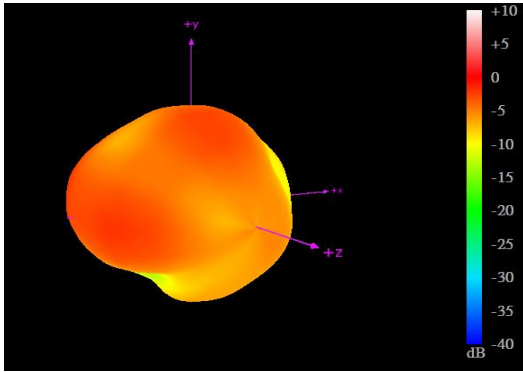

704MHz

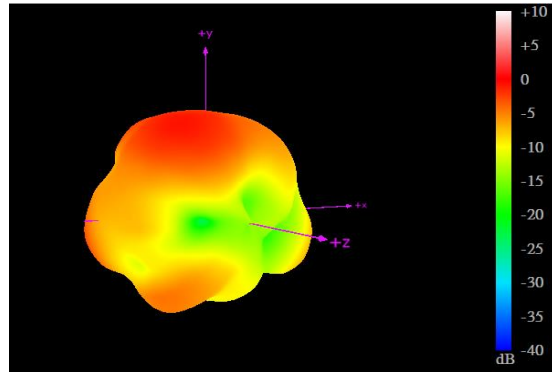

960MHz

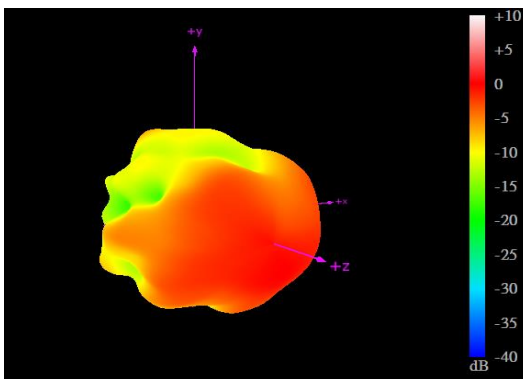

1710MHz

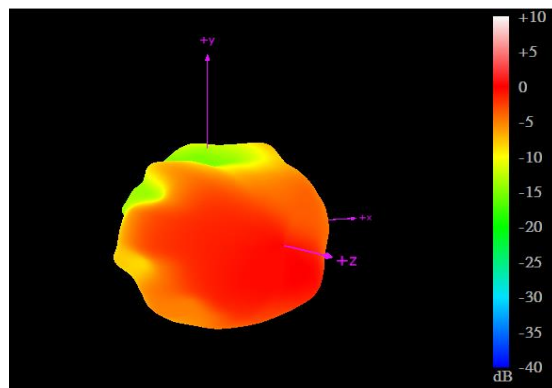

2170MHz

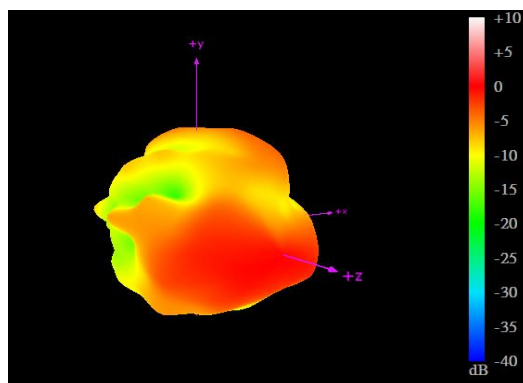

2690MHz

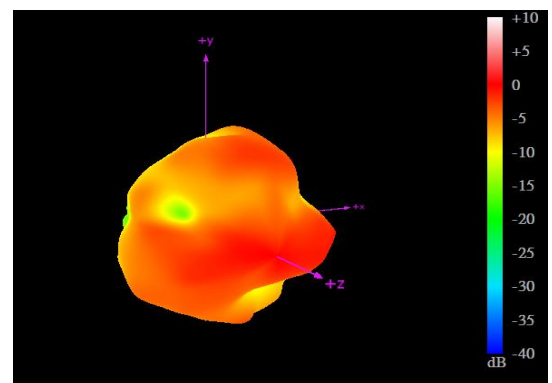

3500MHz

3.3.49 2D Radiation Pattern (LTE_MIMO2 with 1M cable length on metal) XY Plane

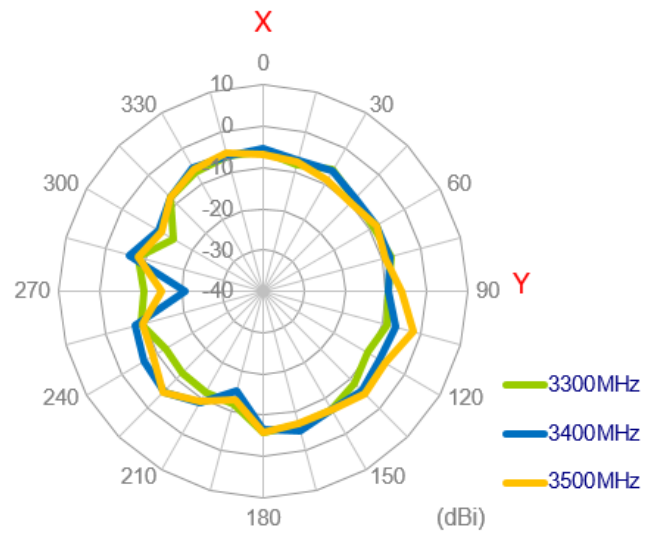
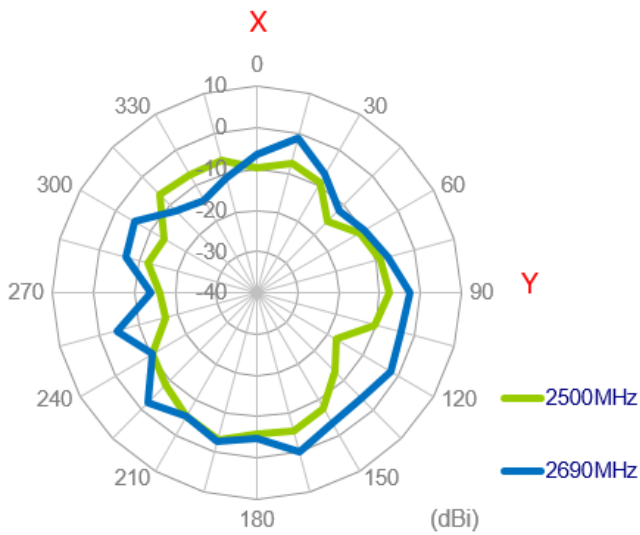
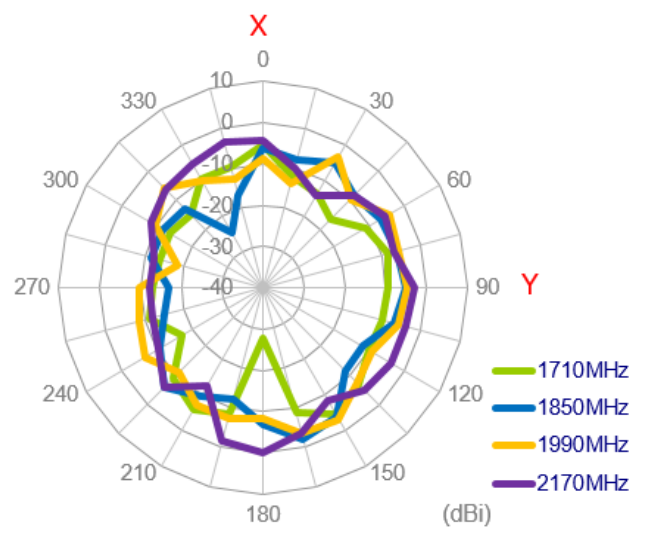
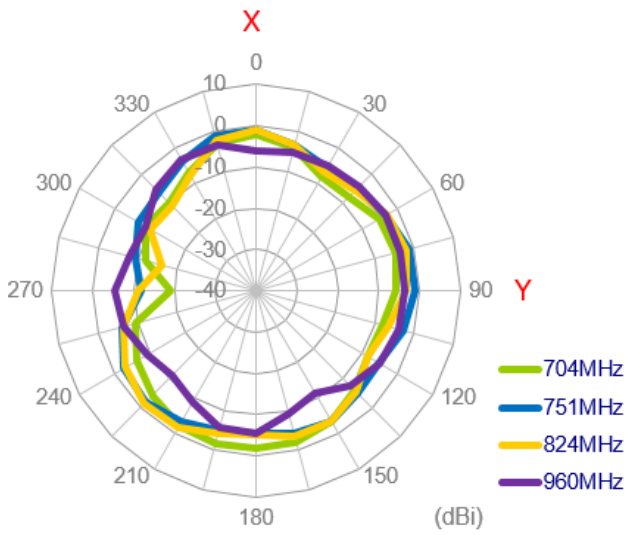

XZ Plane

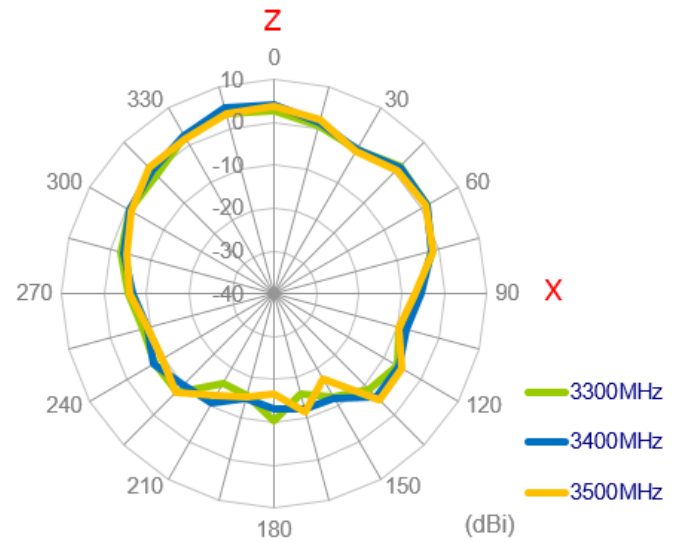
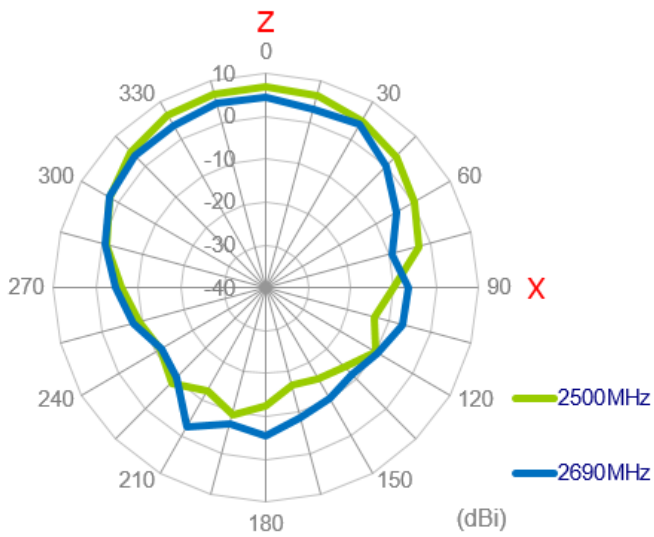
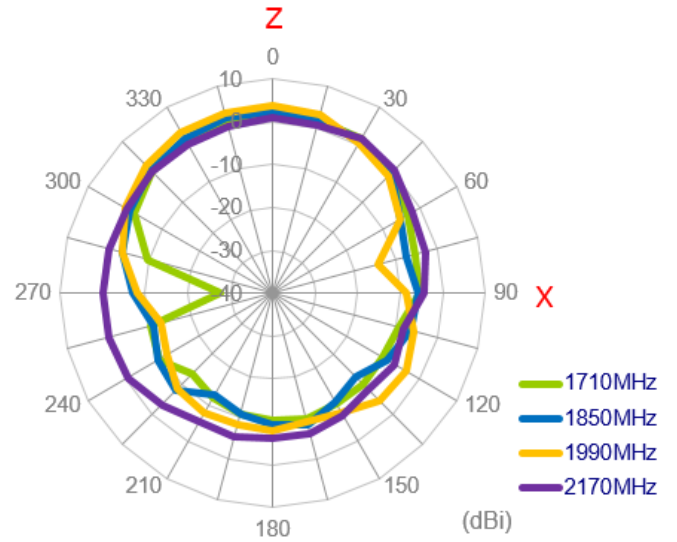
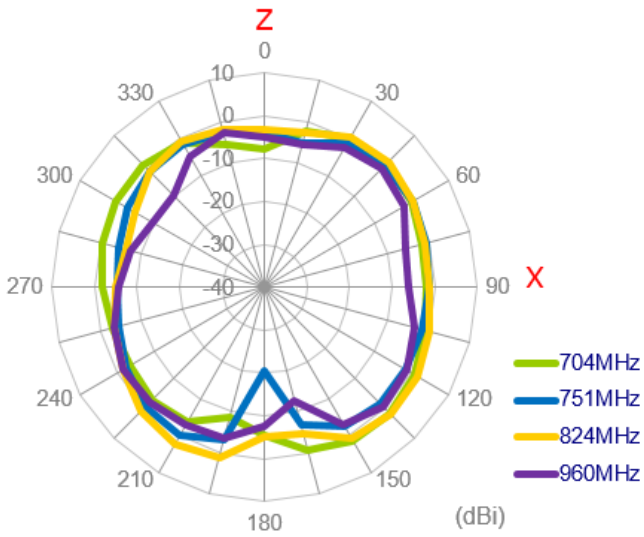

YZ Plane

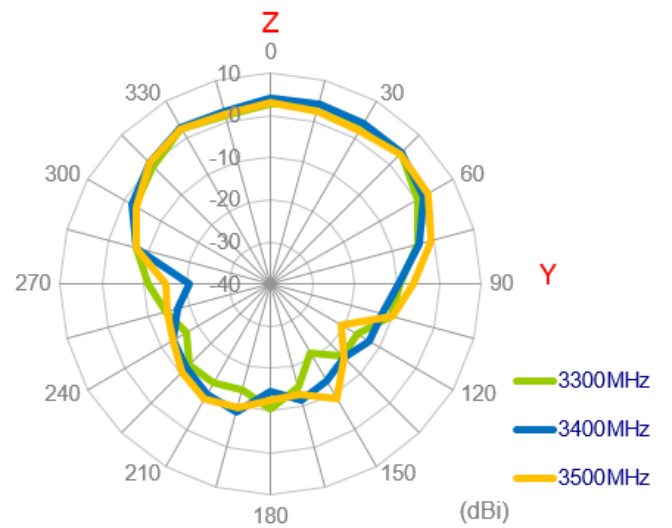
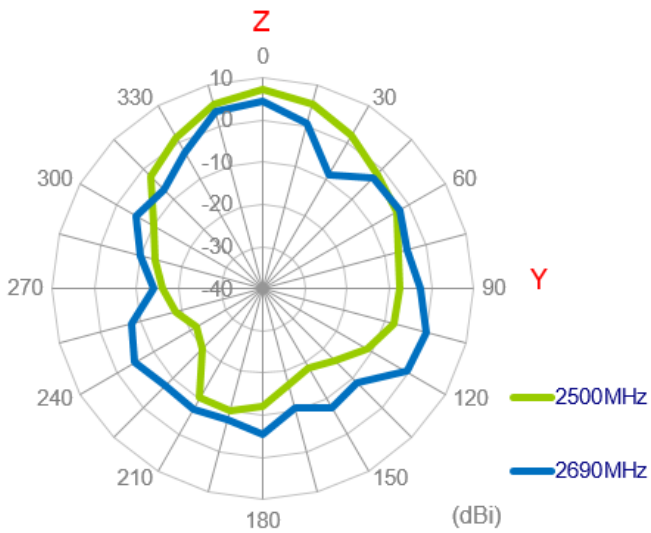
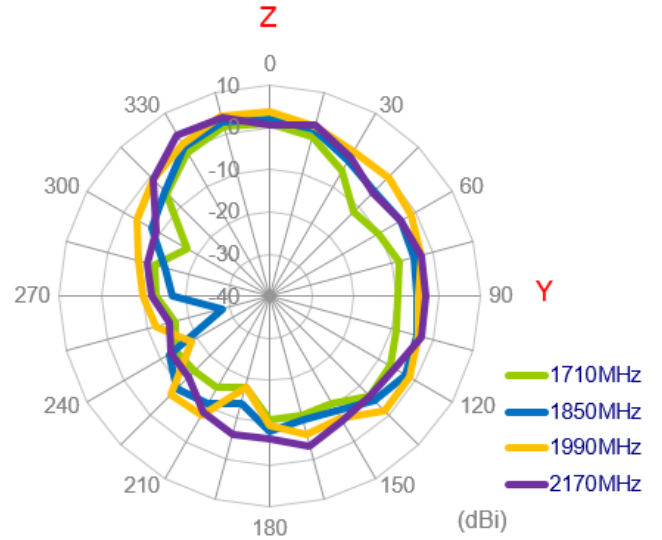
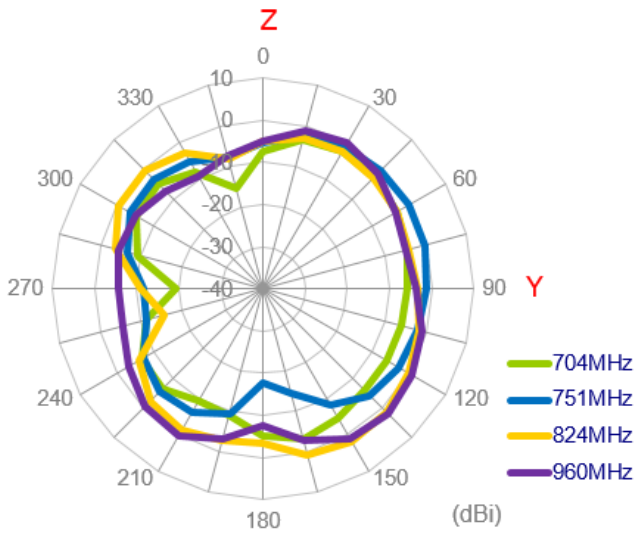

3.3.50 3D Radiation Pattern (LTE_MIMO2 with 1M cable length on metal)

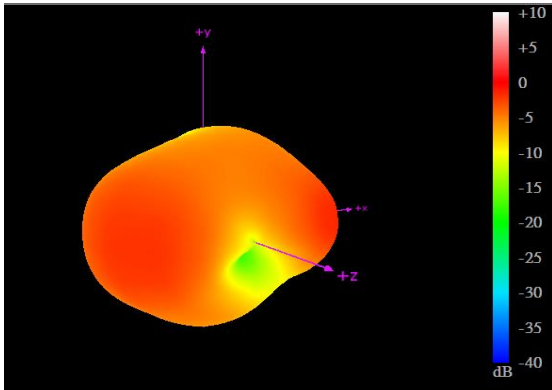

704MHz

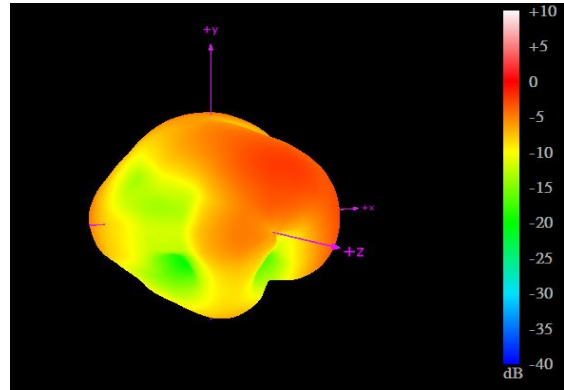

960MHz

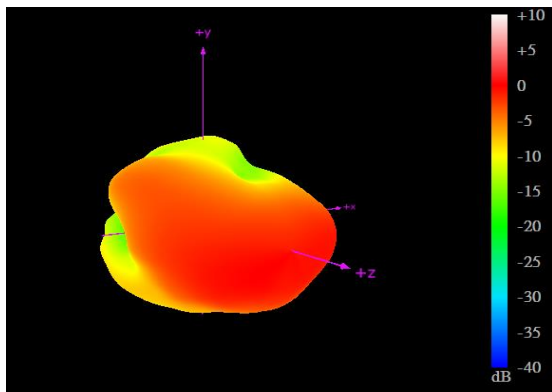

1710MHz

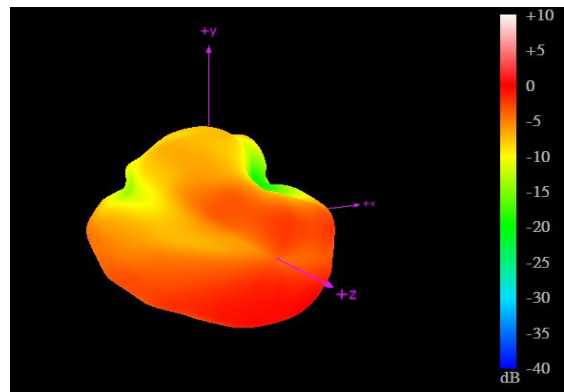

2170MHz

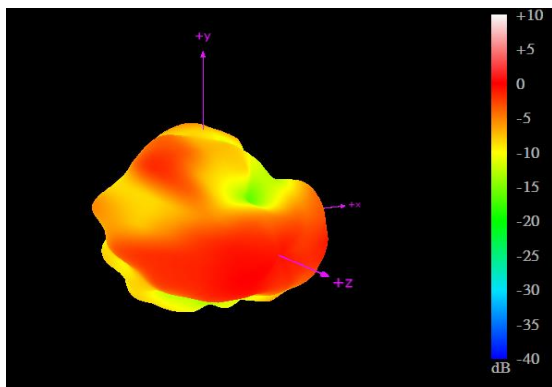

2690MHz

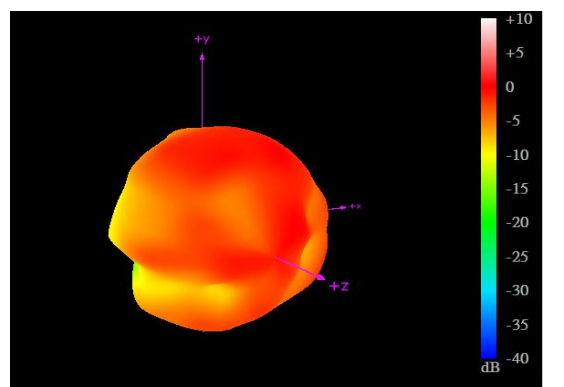

3500MHz

3.3.51 2D Radiation Pattern (Wi-Fi_MIMO1 with 1M cable length on metal)

XY Plane

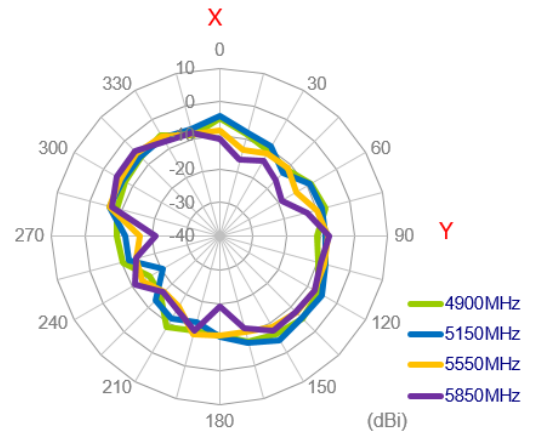
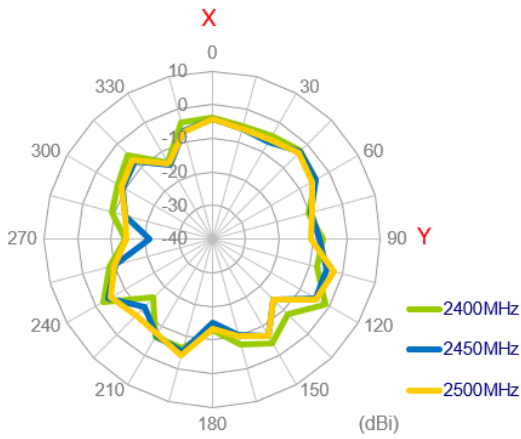

XZ Plane

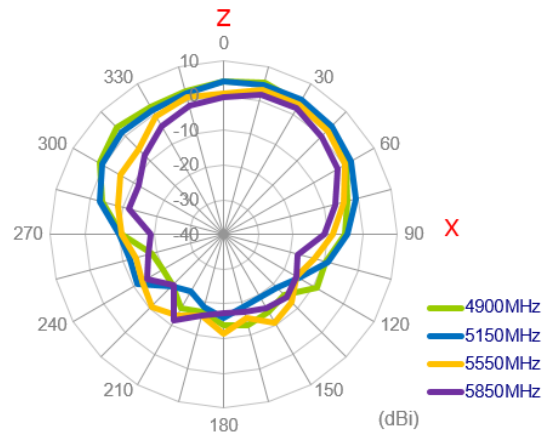
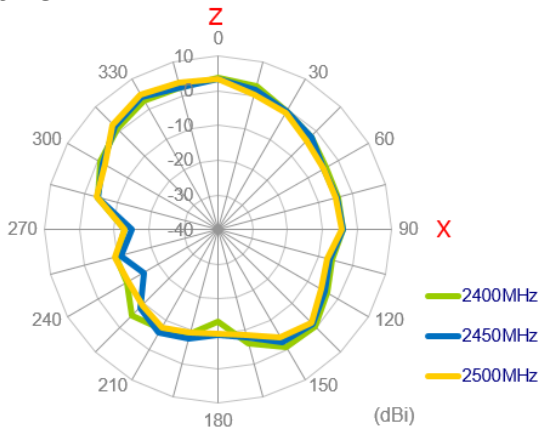

YZ Plane

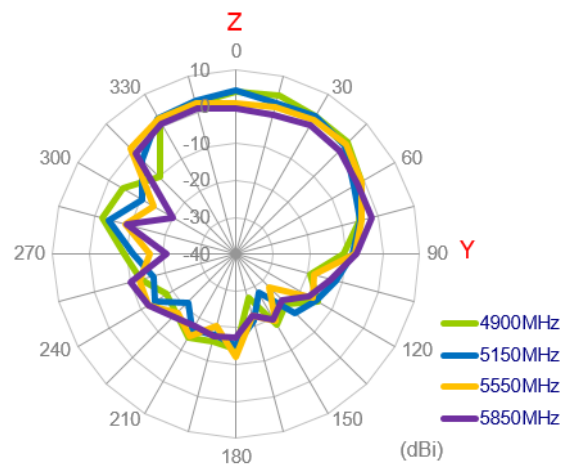
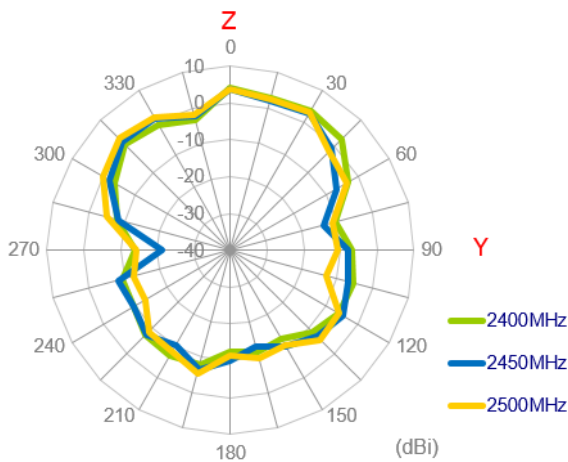

3.3.52 3D Radiation Pattern (Wi-Fi_MIMO1 with 1M cable length on metal)

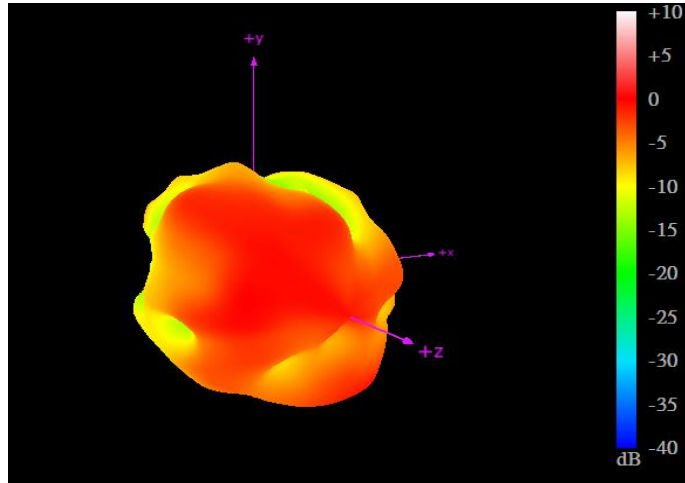

2450MHz

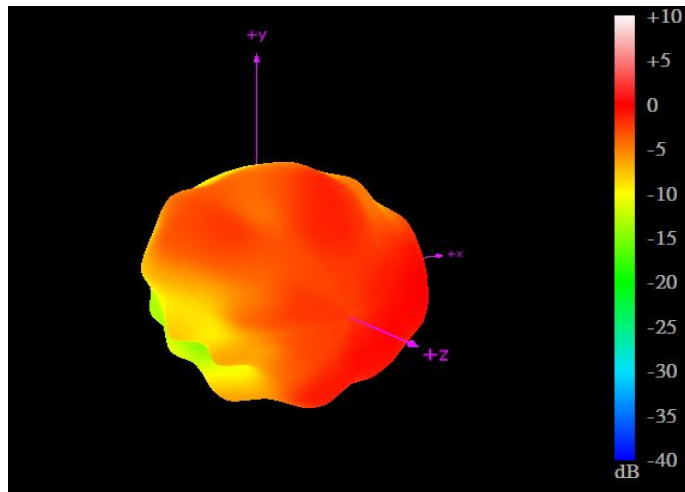

5550MHz

3.3.53 2D Radiation Pattern (Wi-Fi_MIMO2 with 3M cable length on metal)

XY Plane

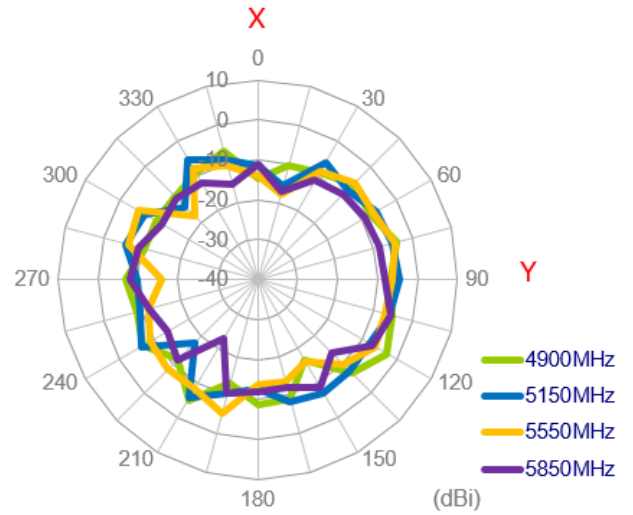
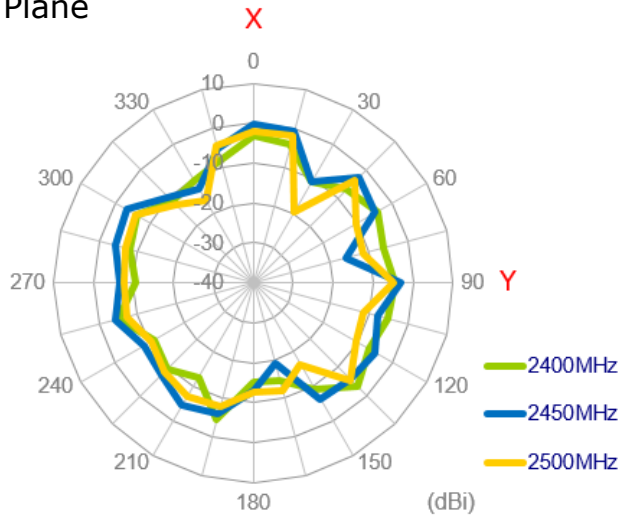

XZ Plane

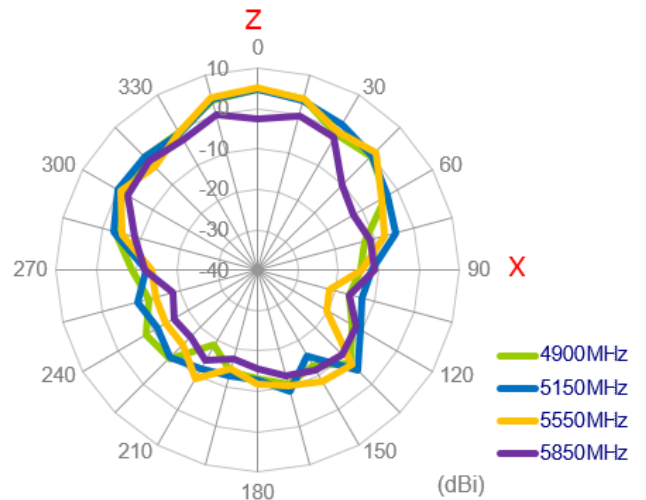
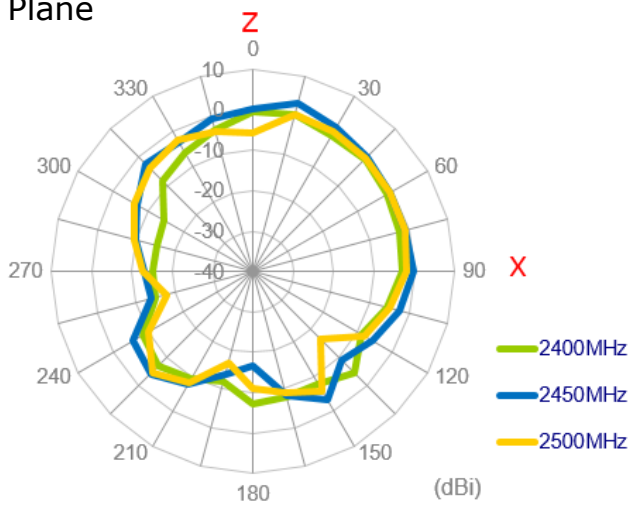

YZ Plane

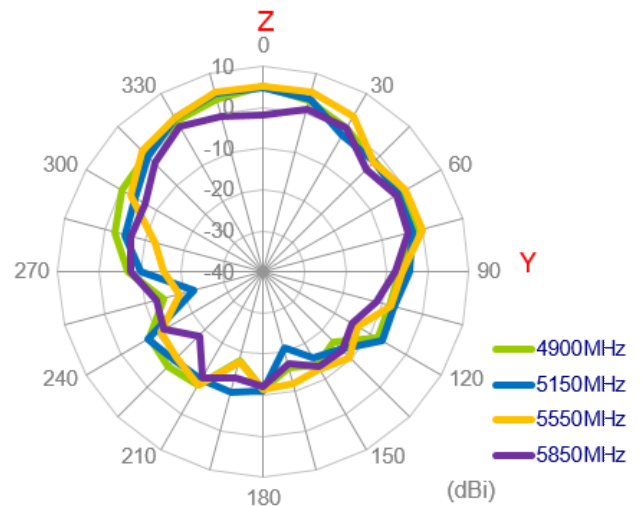
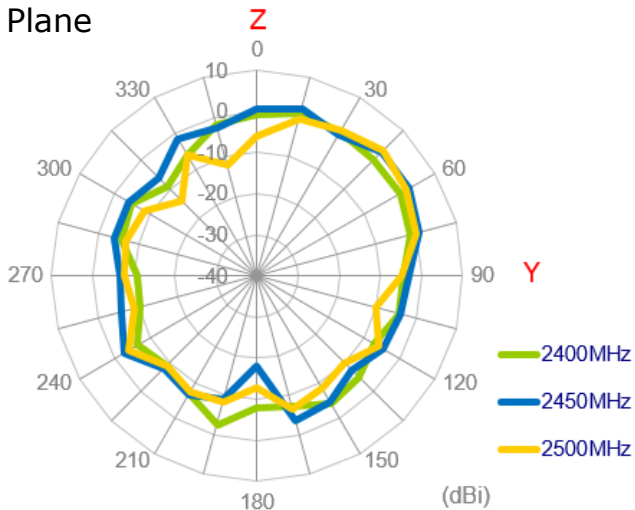

3.3.54 3D Radiation Pattern (Wi-Fi_MIMO2 with 1M cable length on metal)

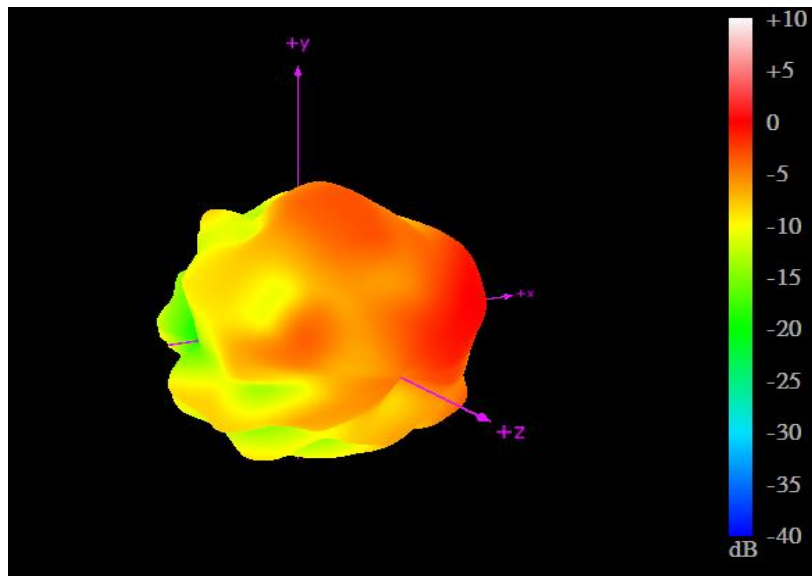

2450MHz

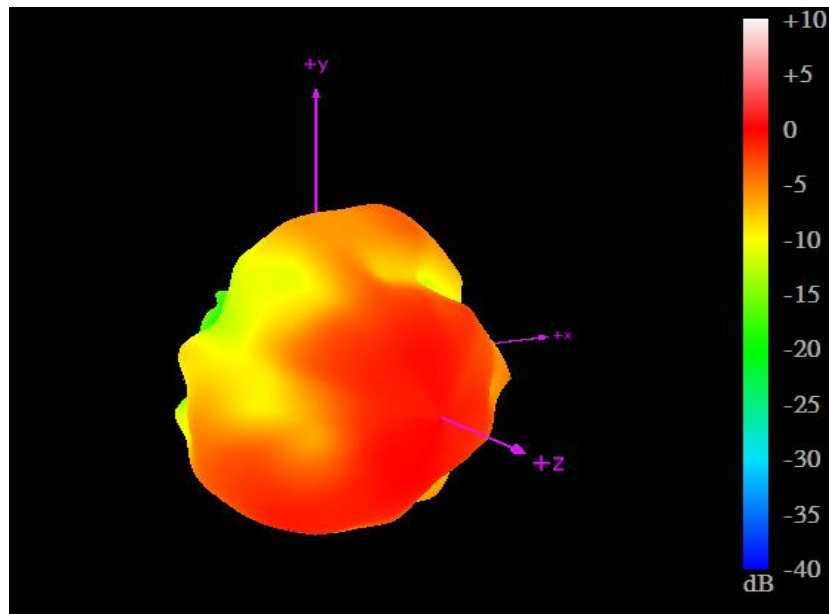

5550MHz

3.3.55 Test Setup for Antenna Radiation Pattern

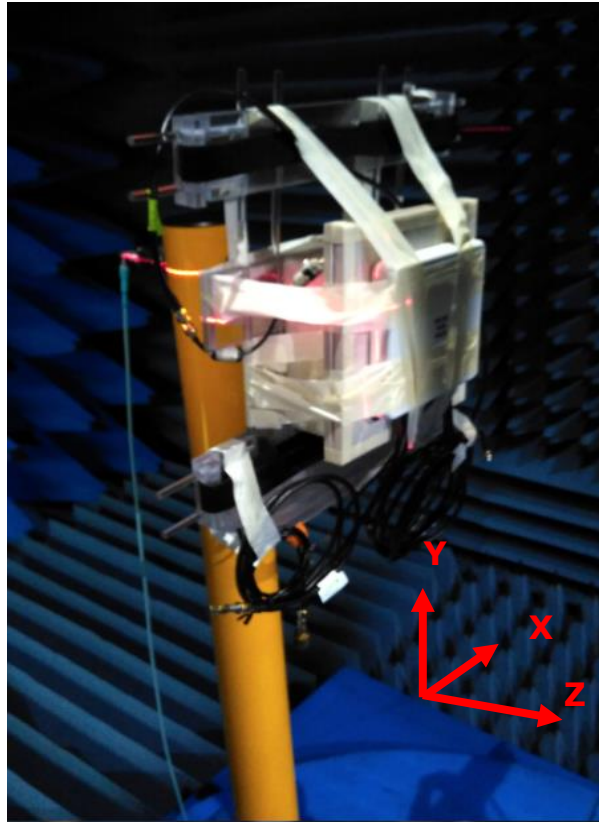

On the Wall

3.3.56 2D Radiation Pattern (LTE_MIMO1 with 1M cable length on the wall)

XY Plane

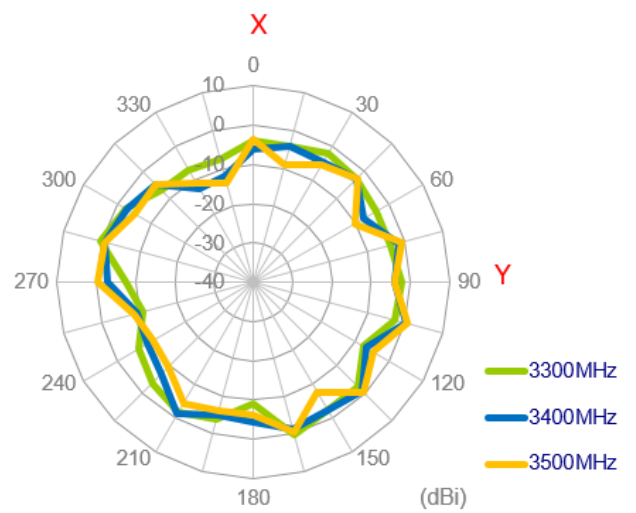
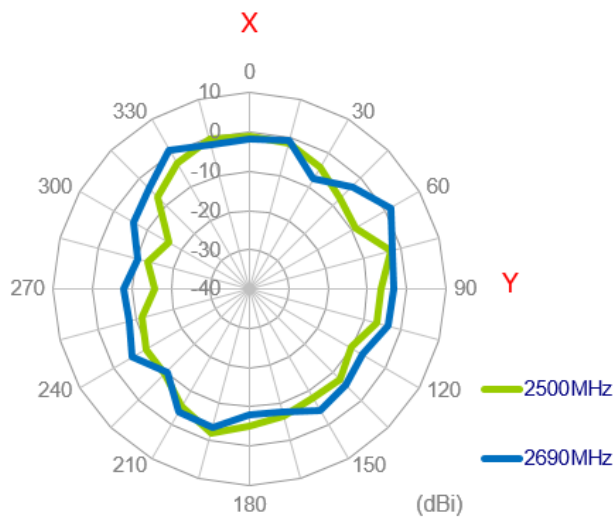
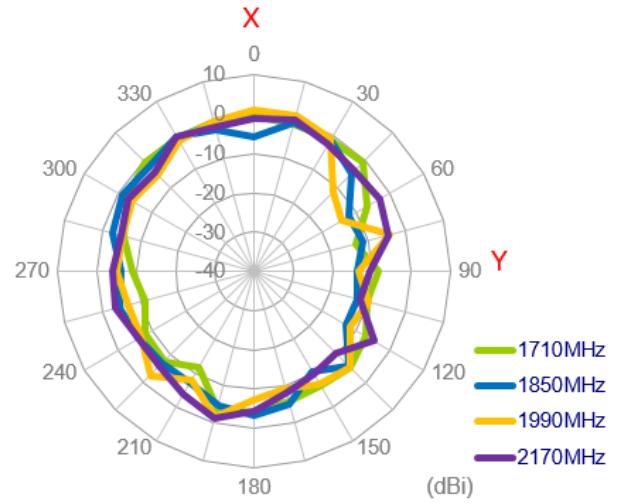
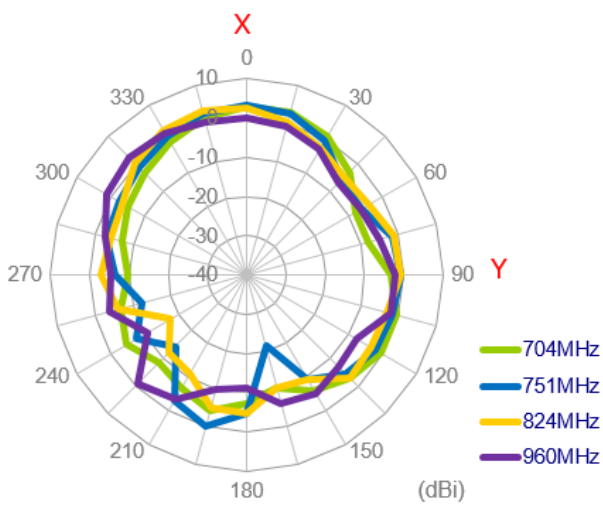

XZ Plane

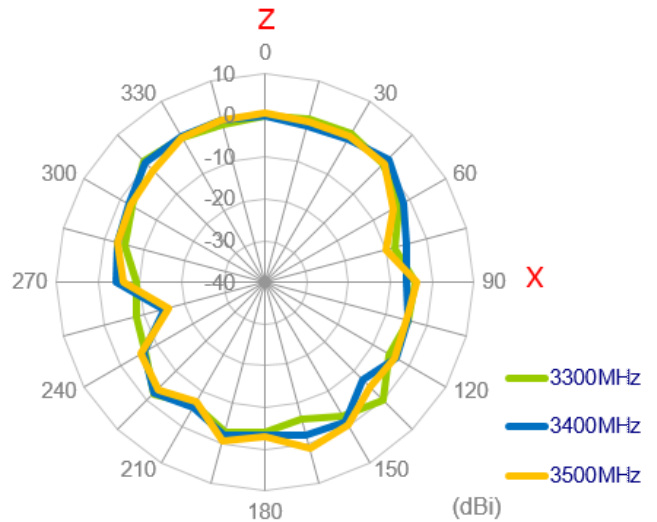
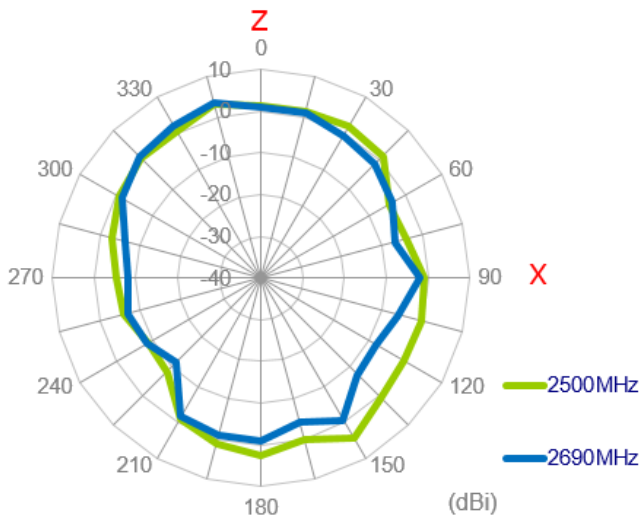
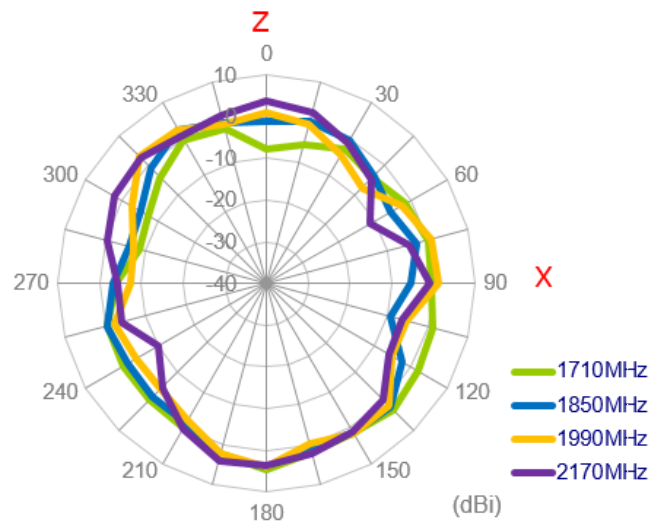
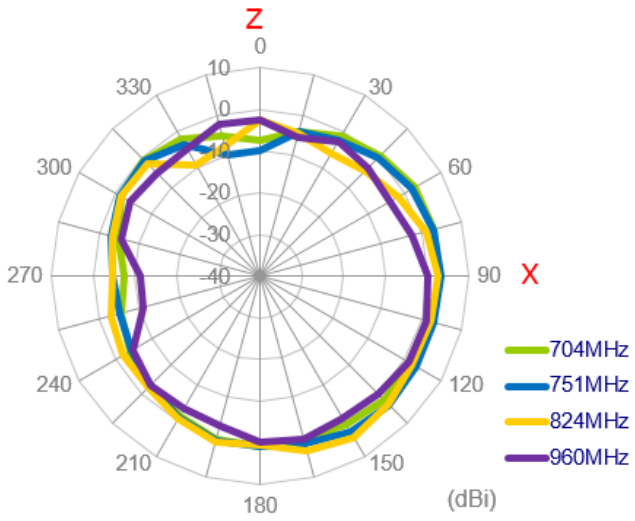

YZ Plane

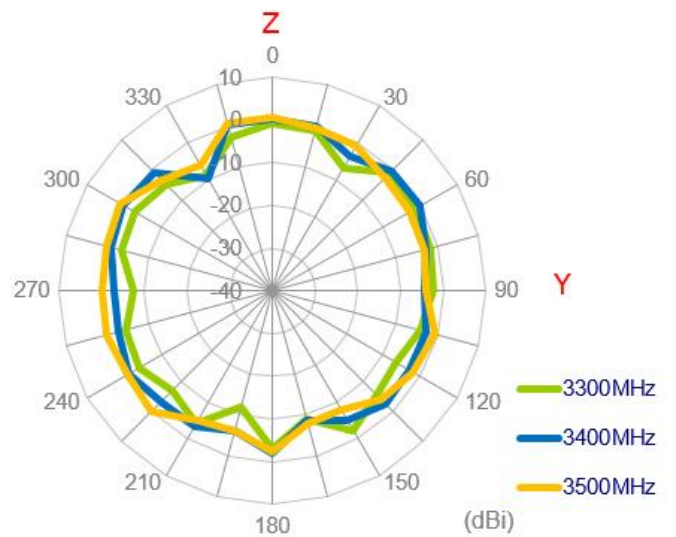
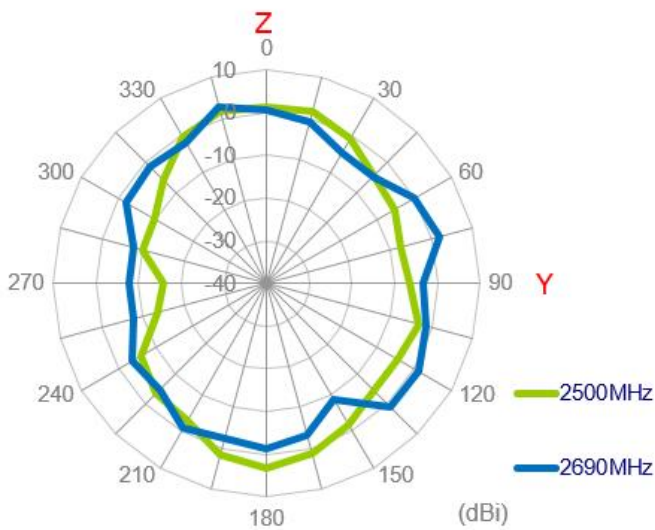
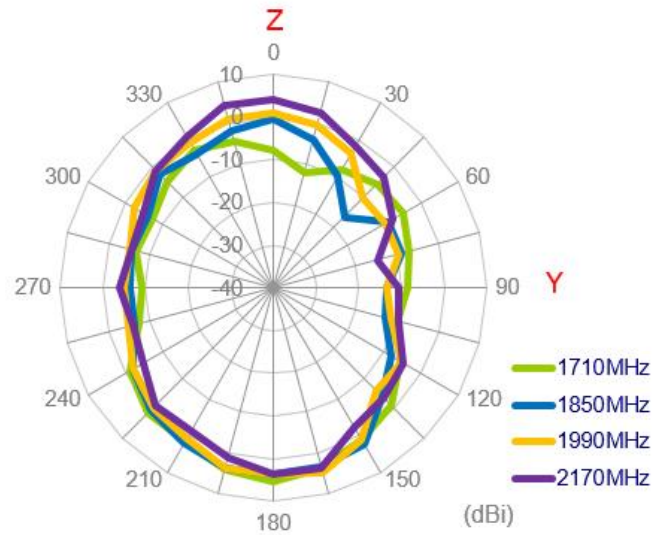
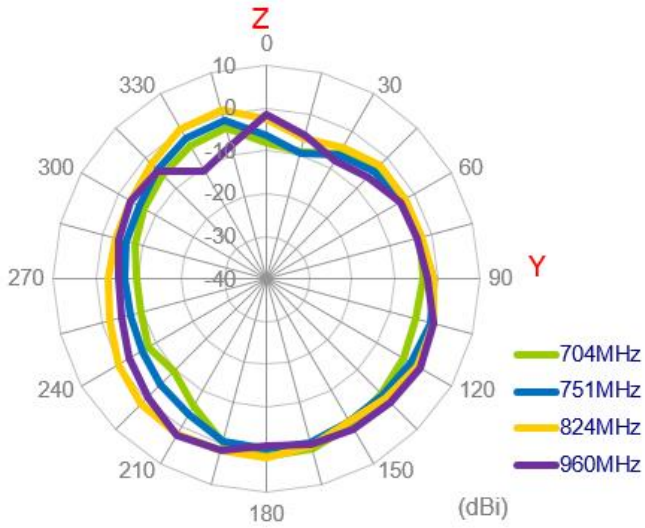

3.3.57 3D Radiation Pattern (LTE_MIMO1 with 1M cable length on the wall)

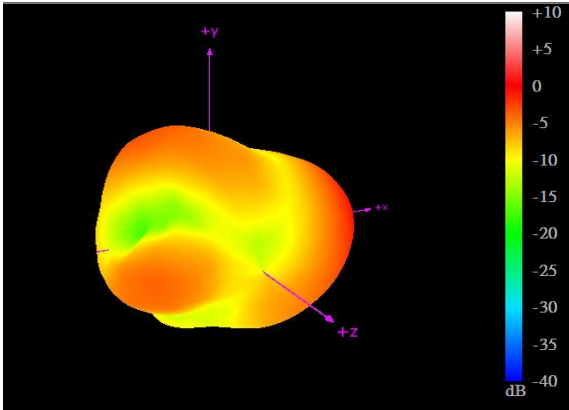

704MHz

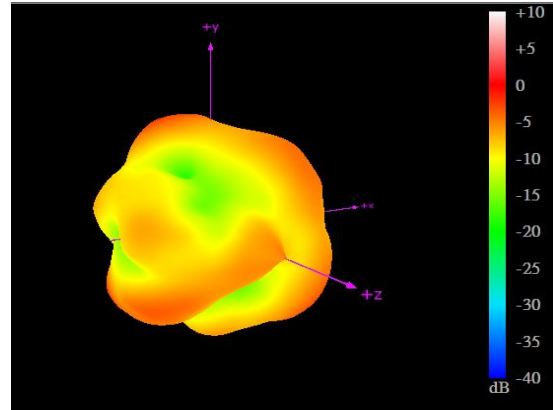

960MHz

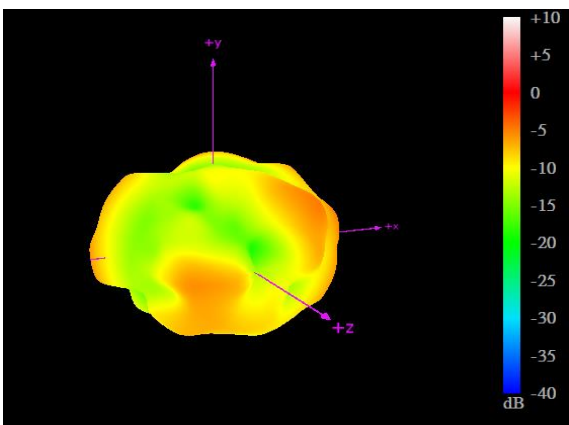

1710MHz

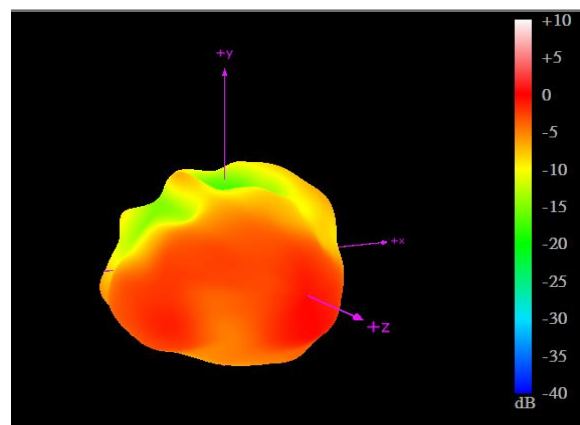

2170MHz

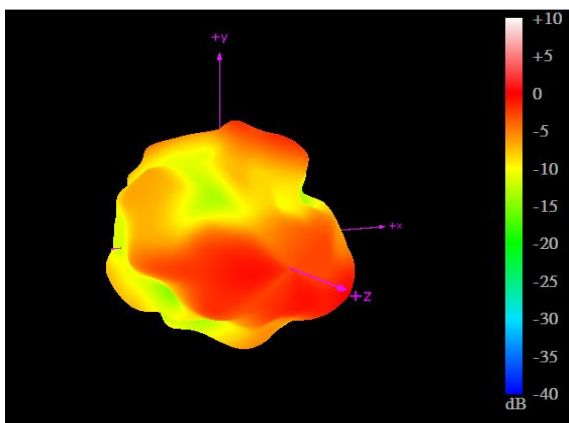

2690MHz

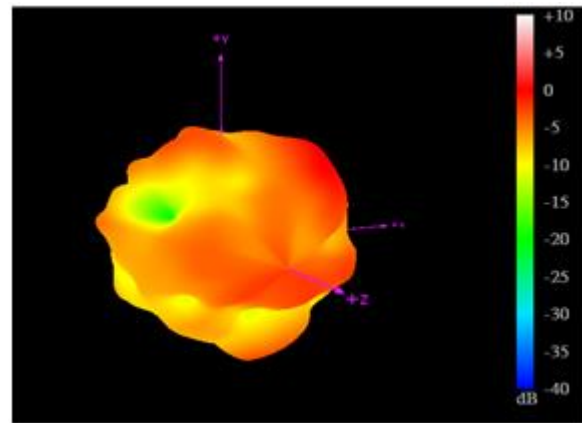

3500MHz

3.3.58 2D Radiation Pattern (LTE_MIMO2 with 1M cable length on the wall)

XY Plane

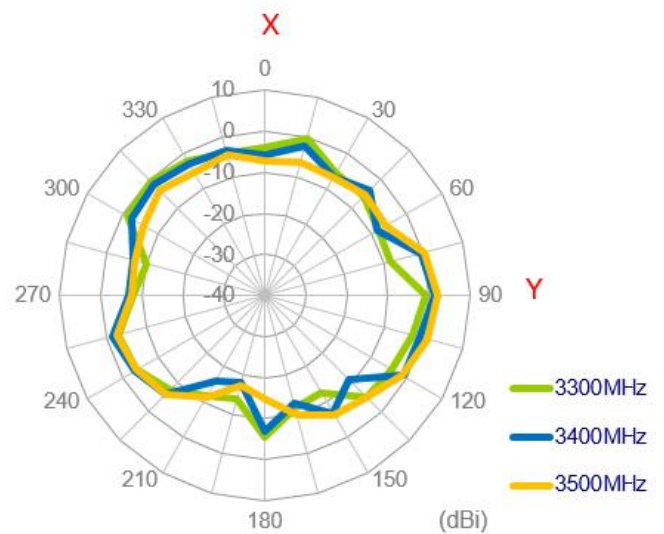
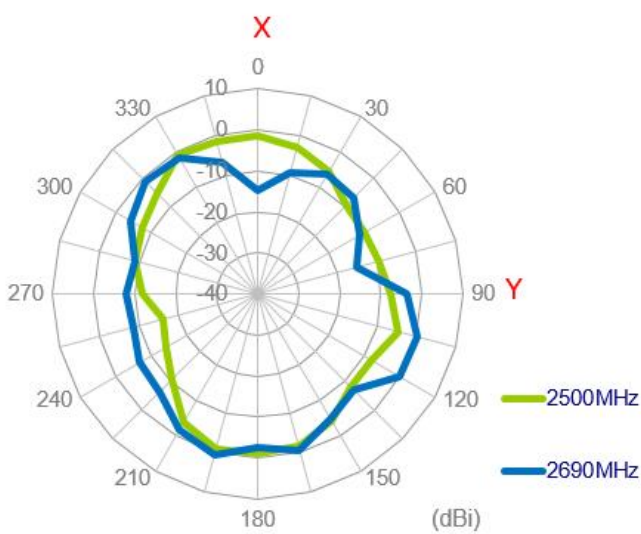
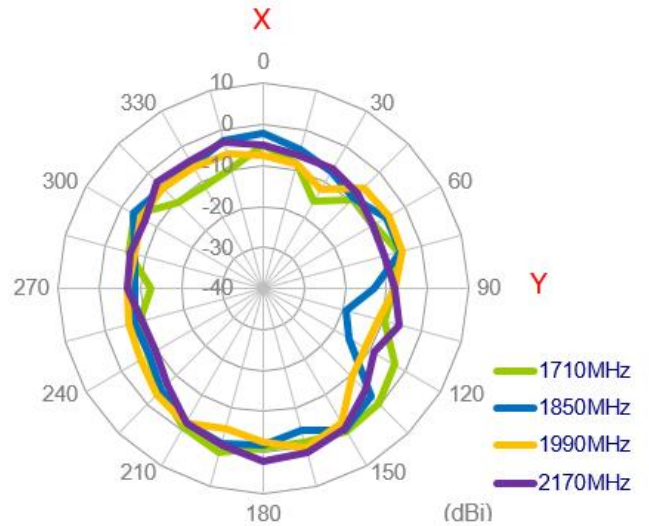
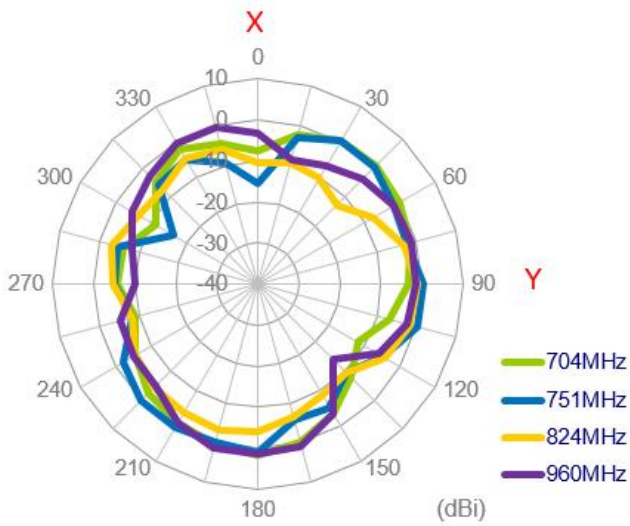

XZ Plane

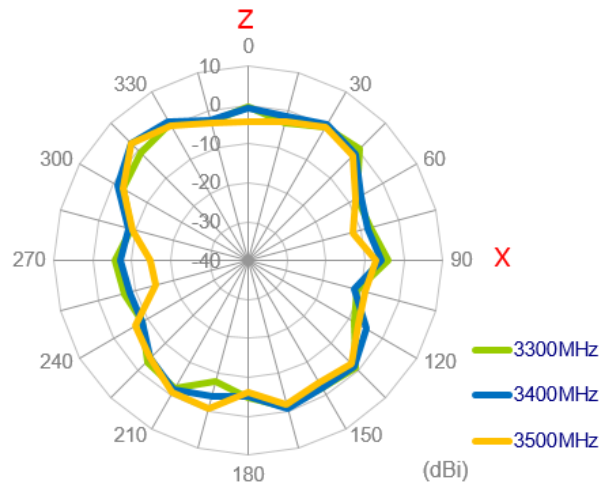
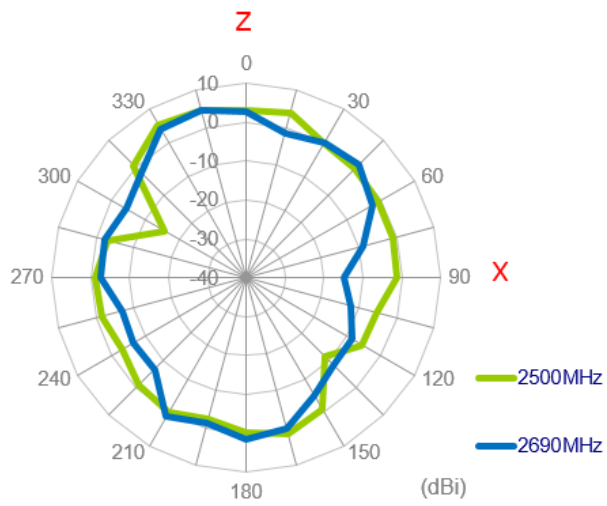
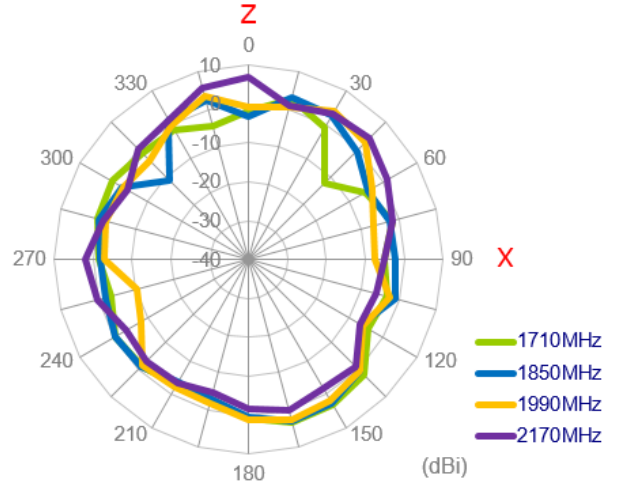
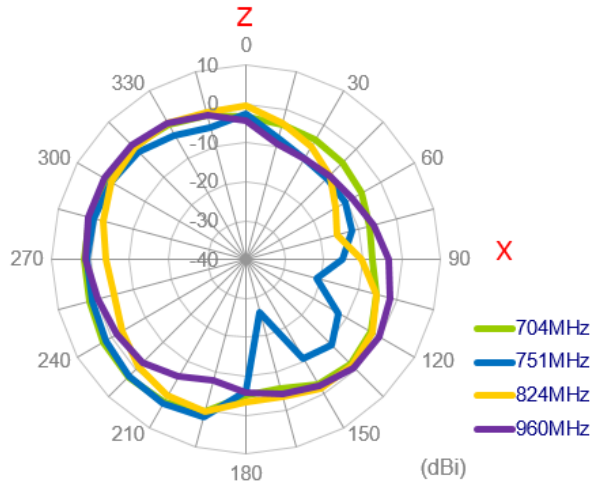

YZ Plane

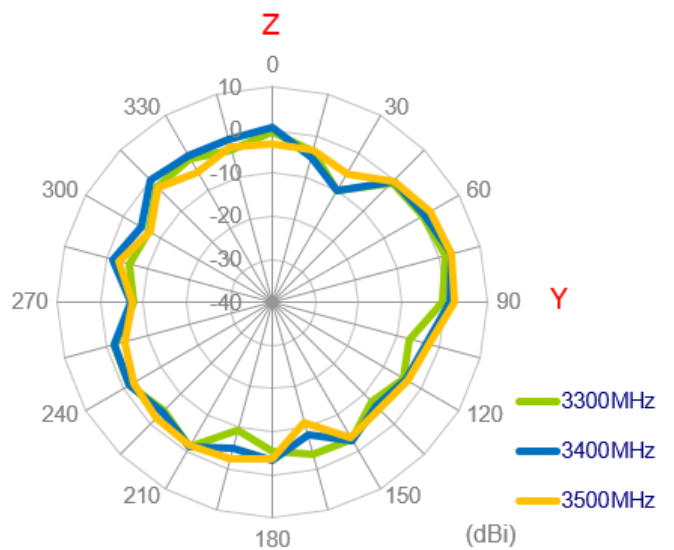
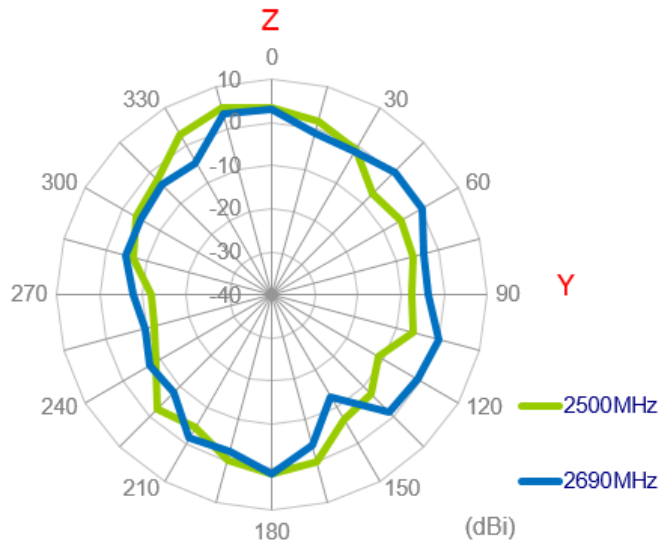
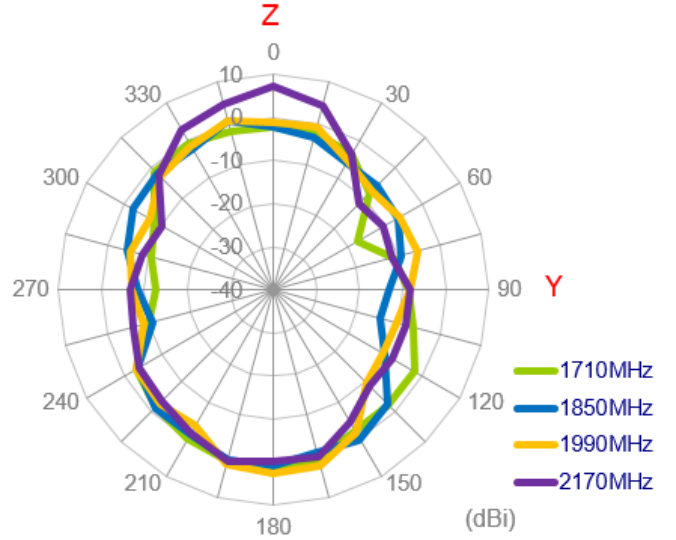
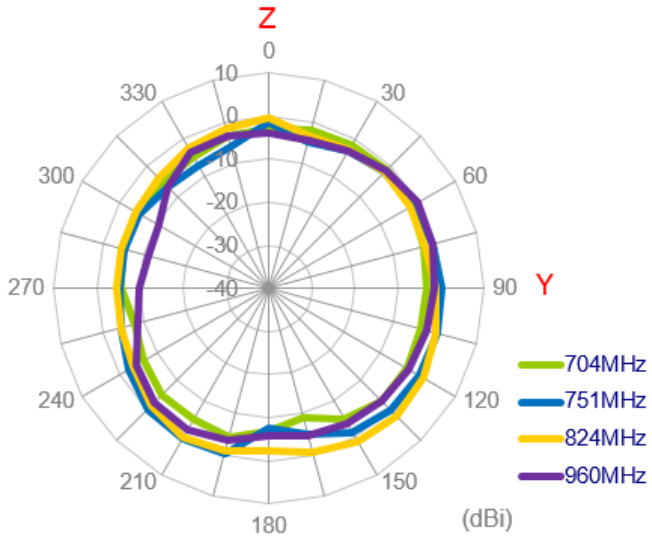

3.3.59 3D Radiation Pattern (LTE_MIMO2 with 1M cable length on the wall)

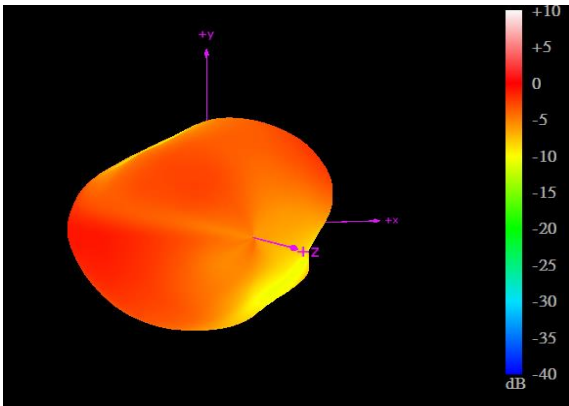

704MHz

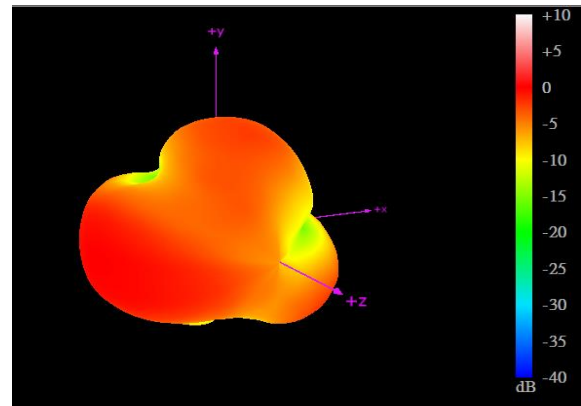

960MHz

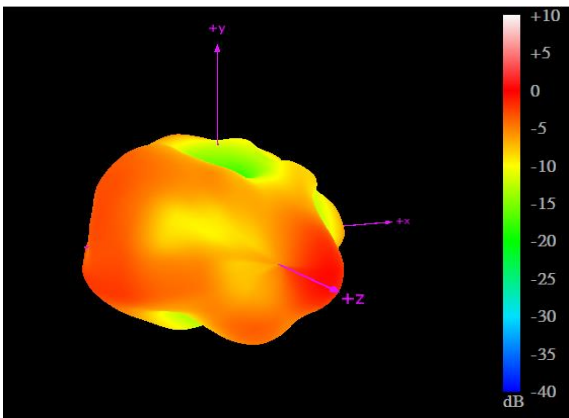

1710MHz

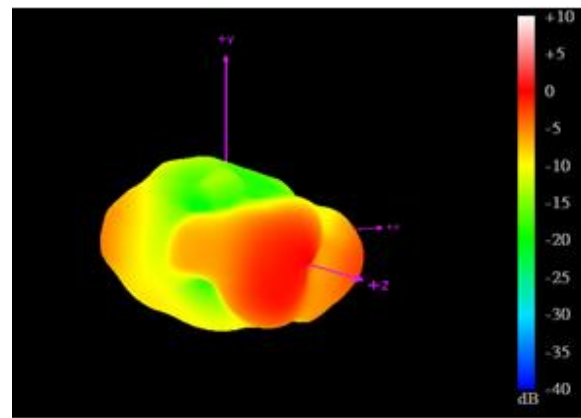

2170MHz

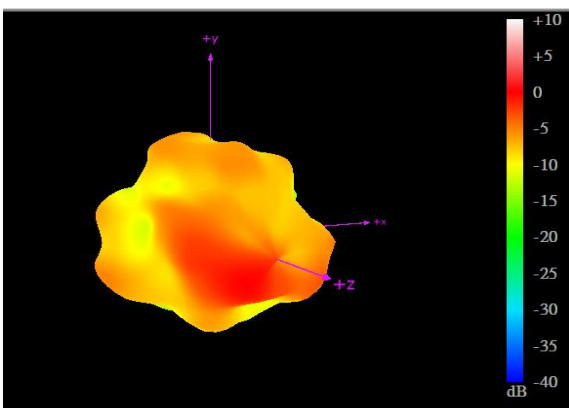

2690MHz

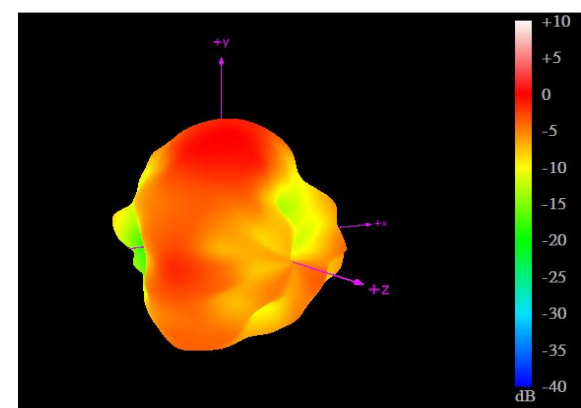

3500MHz

3.3.60 2D Radiation Pattern (Wi-Fi_MIMO1 with 1M cable length in free space)

XY Plane

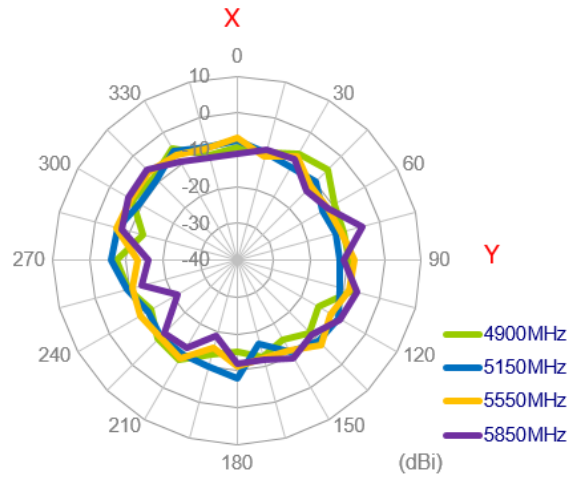
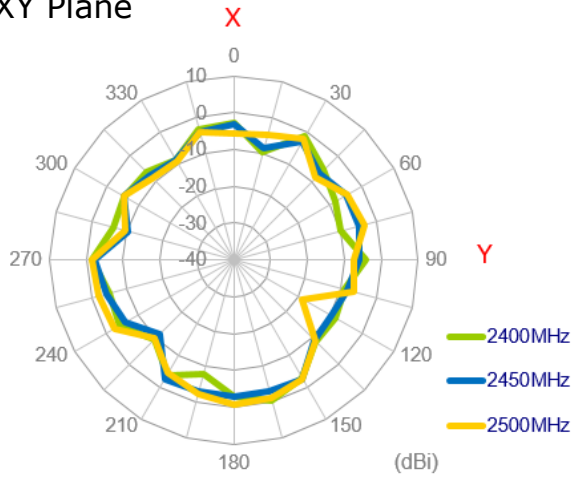

XZ Plane

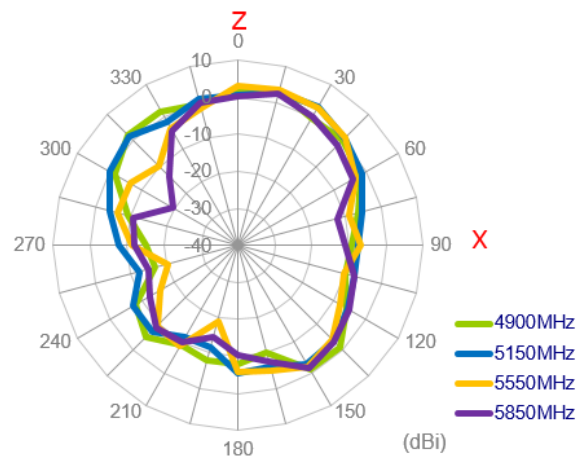
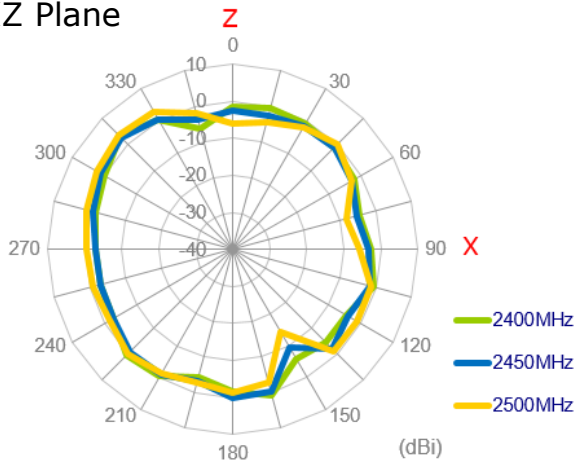

YZ Plane

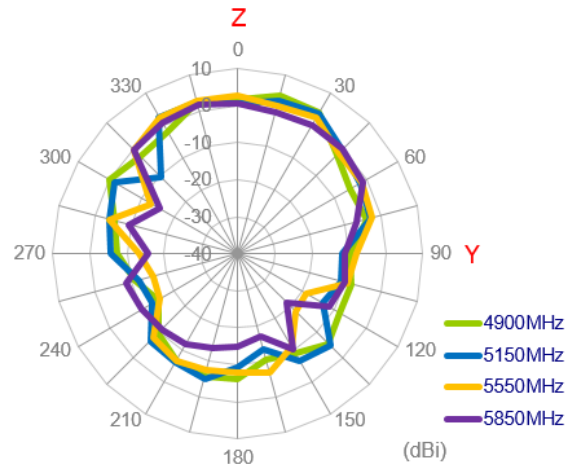
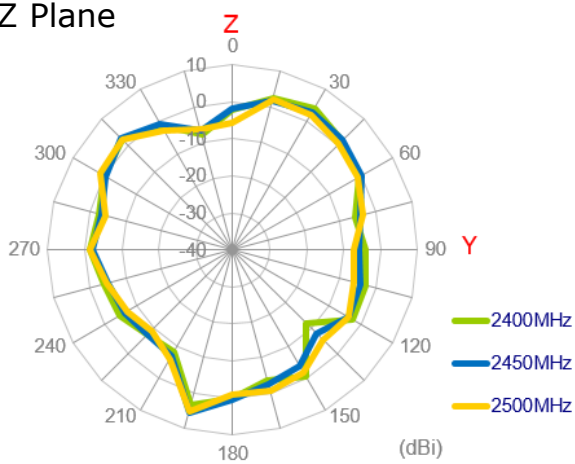

3.3.61 3D Radiation Pattern (Wi-Fi_MIMO1 with 1M cable length in free space)

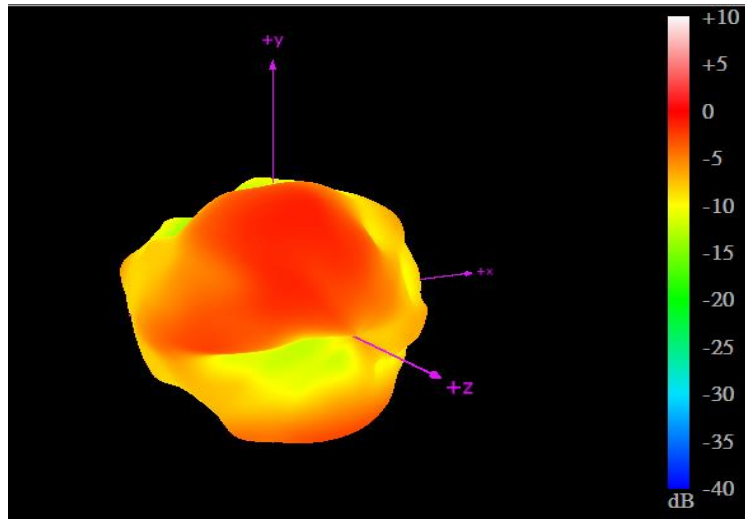

2450MHz

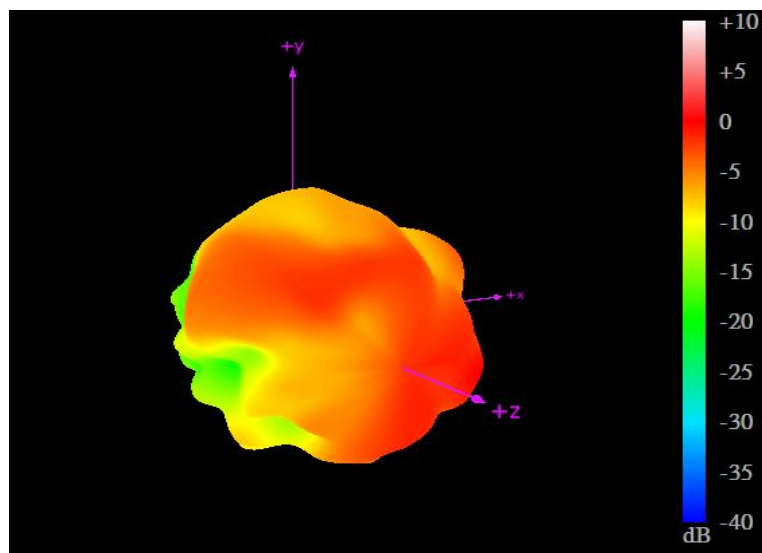

5550MHz

3.3.62 2D Radiation Pattern (Wi-Fi_MIMO2 with 3M cable length in free space)

XY Plane

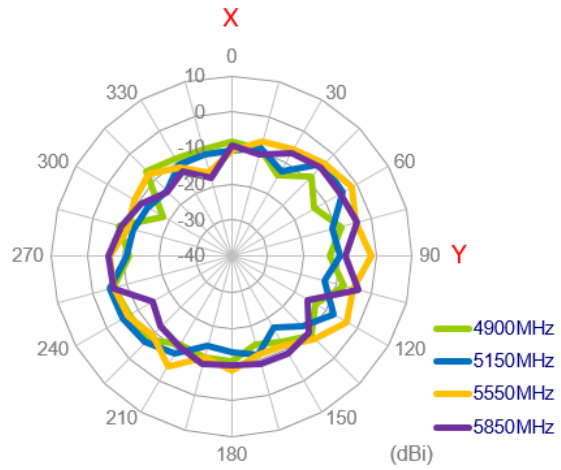
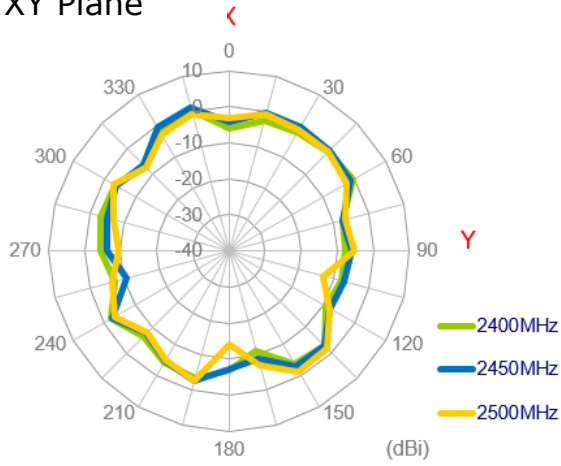

XZ Plane

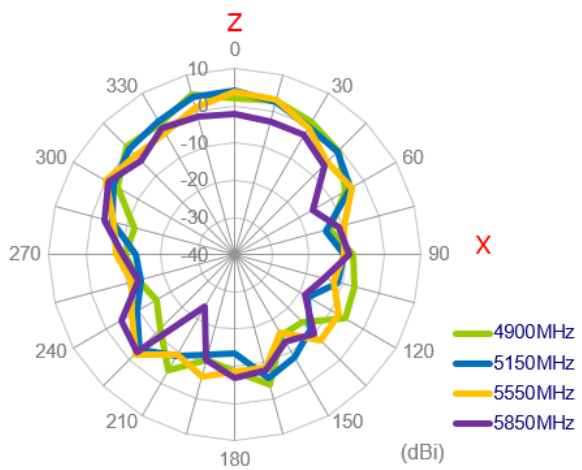
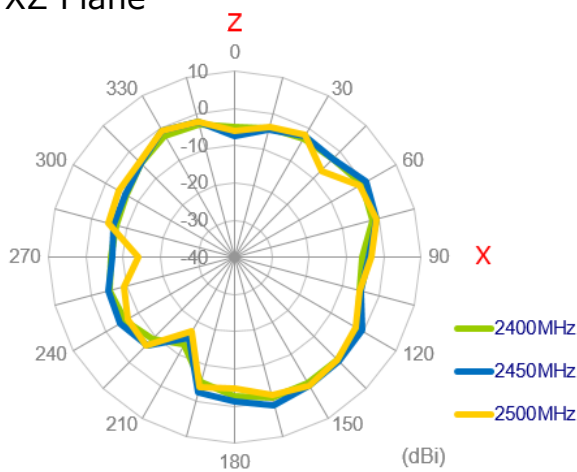

YZ Plane

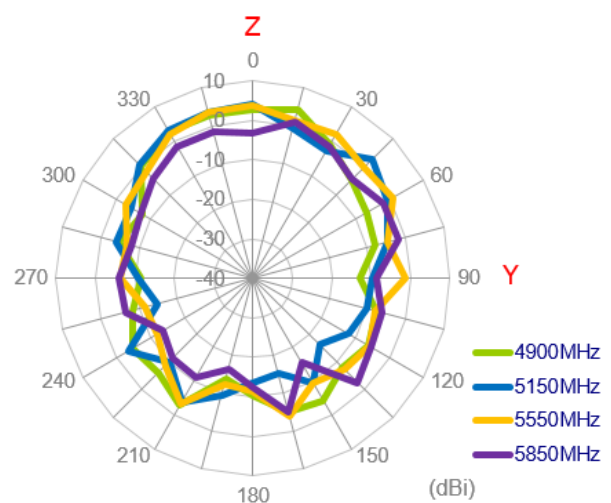
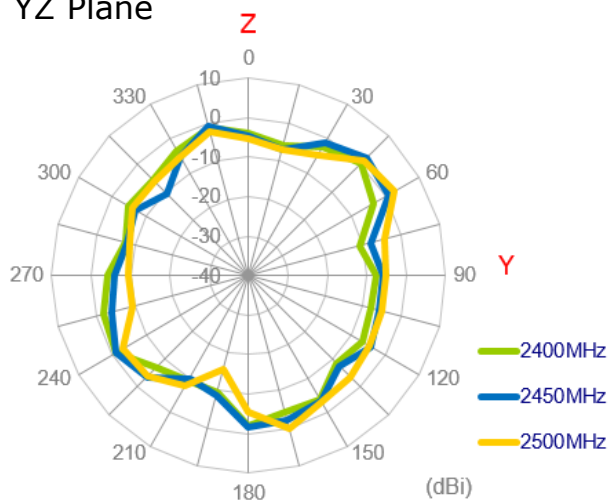

3.3.63 3D Radiation Pattern (Wi-Fi_MIMO2 with 1M cable length in free space)

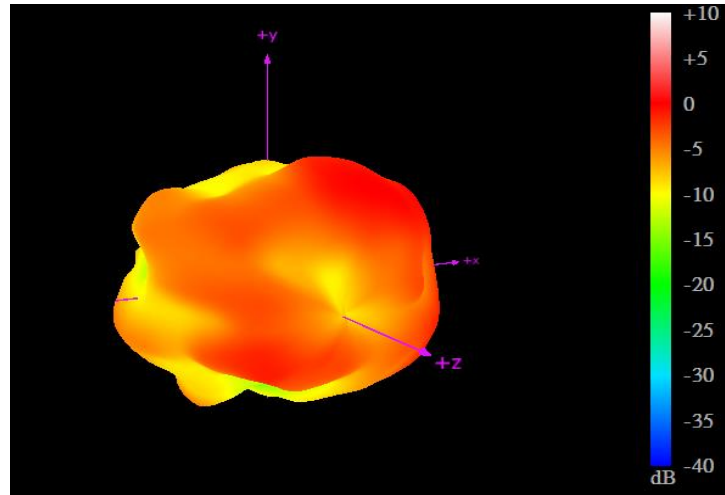

2450MHz

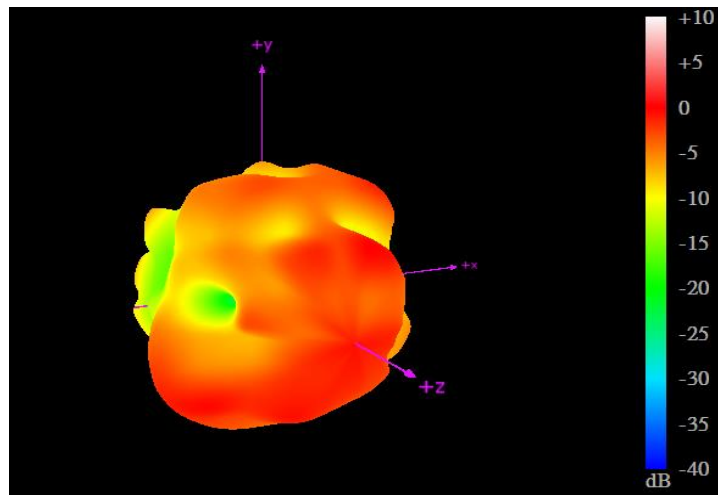

5550MHz

4. Mechanical Drawing (Unit: mm)

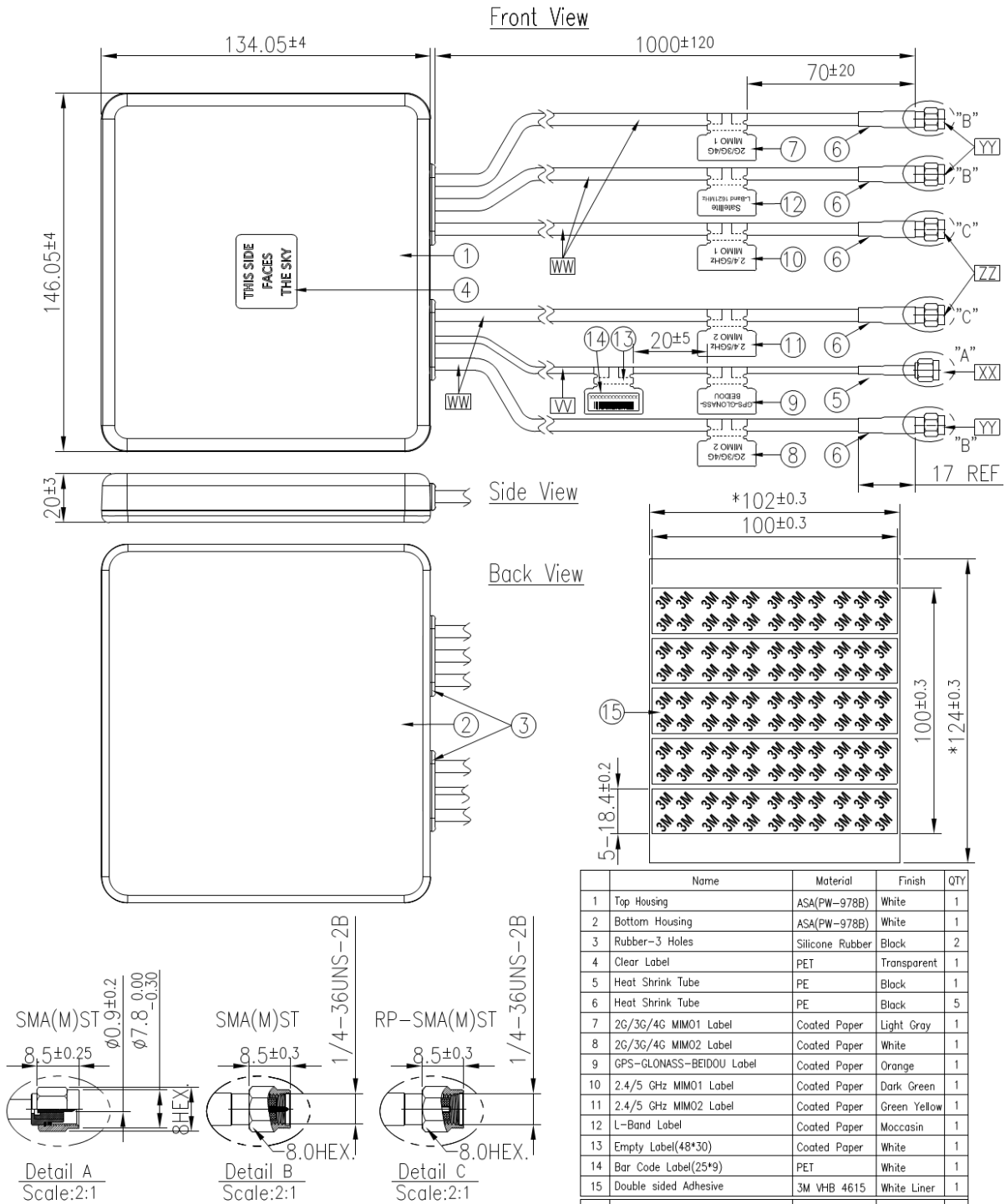

5. Packaging

Packaging Specifications

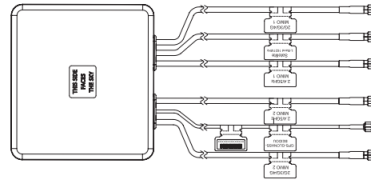

1 No. MA930.W.A.LBICGJ.005 per small box
 Box Dimensions - 250 x 210 x 100mm
 Weight - 680g

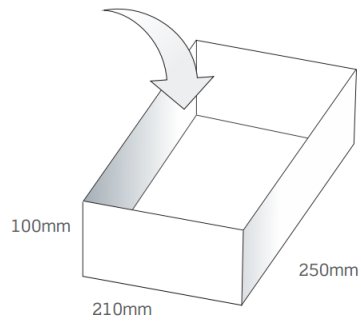

1 Outer Carton
 Carton Dimensions - 520 x 440 x 240mm
 8 pcs MA930.W.A.LBICGJ.005 per carton
 Weight - 6.4Kg

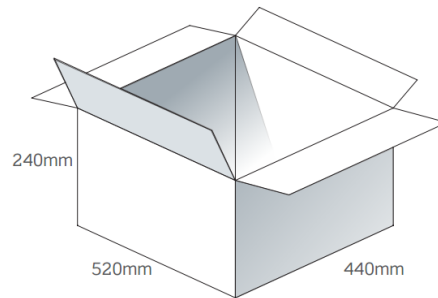

Pallet Dimensions 1200*1000*1400mm
 16 Cartons per Pallet
 4 Cartons per layer
 4 Layers

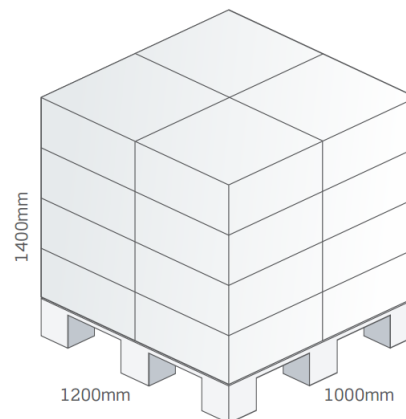

6. Application Note

The MA930 antenna performance with different cable lengths is shown below.

6.1 In free space (LTE)

6.1.1 Return Loss (LTE_MIMO_1)

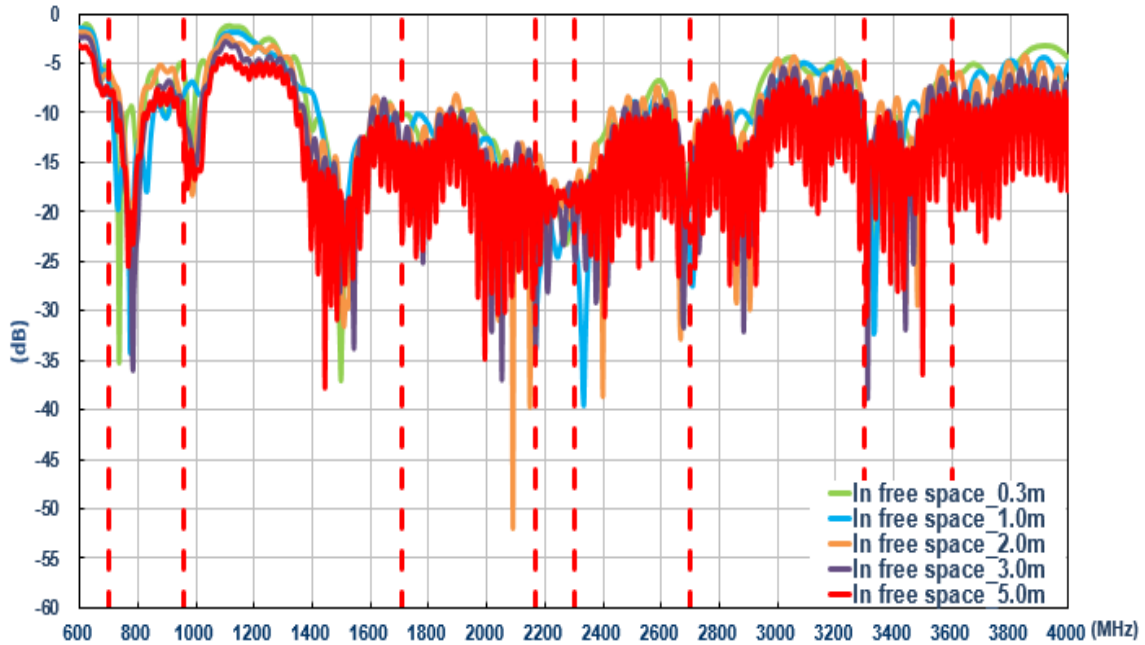

6.1.2 Return Loss (LTE_MIMO_2)

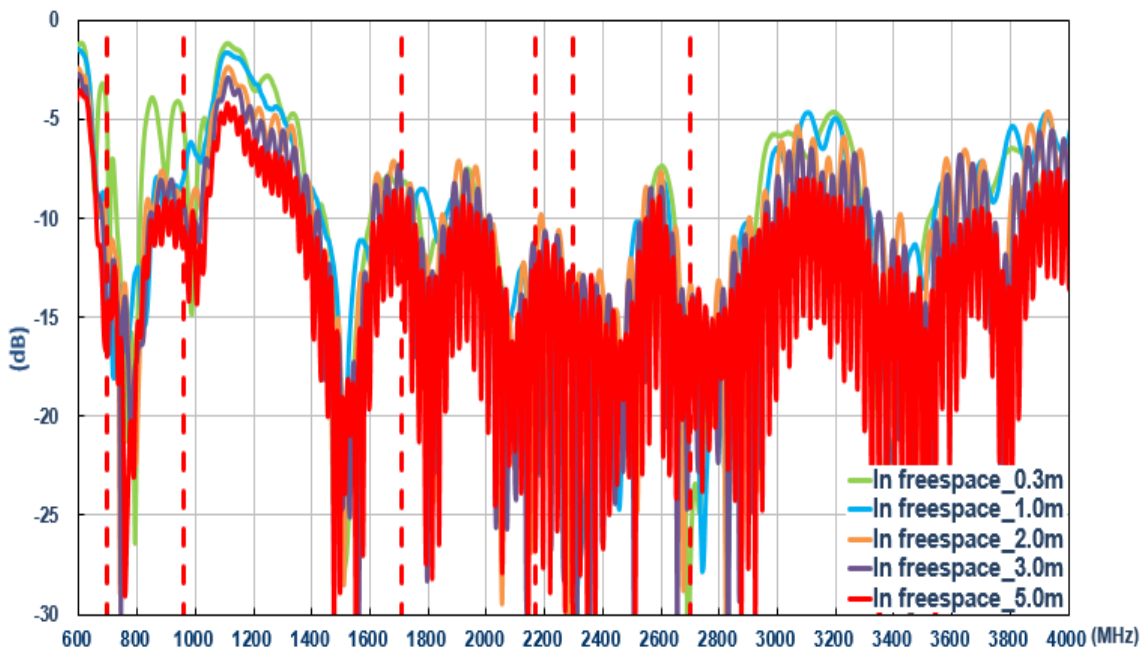

6.1.3 Isolation (LTE antenna)

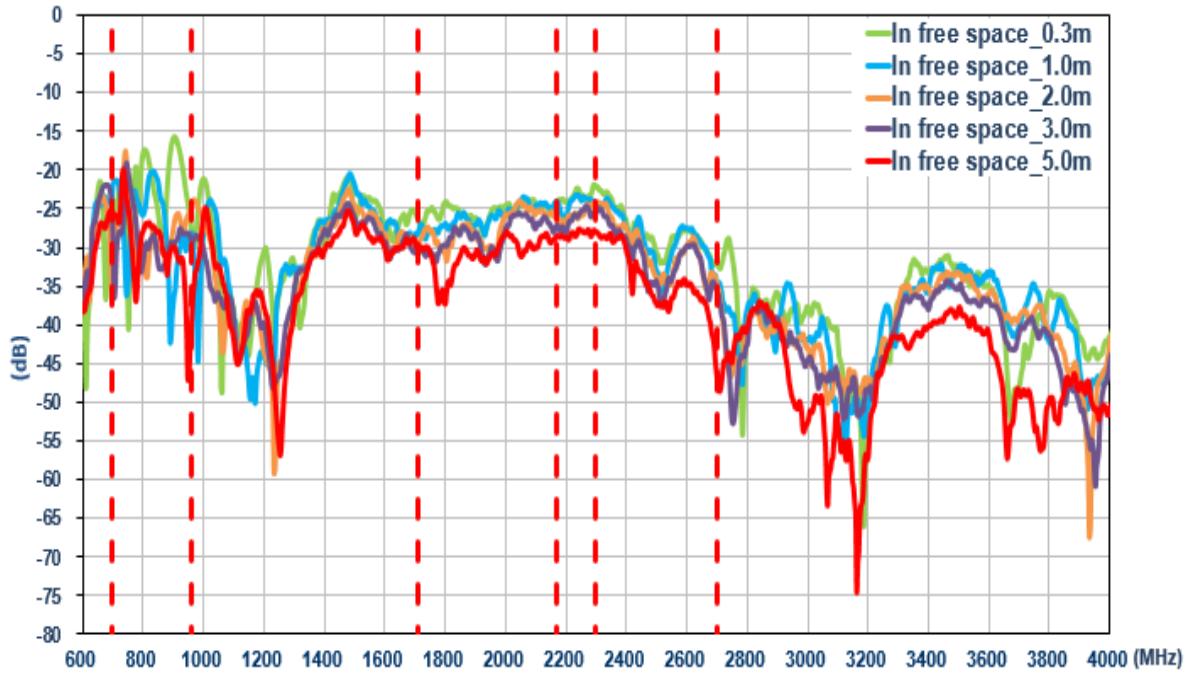

6.1.4 Efficiency (LTE MIMO_1)

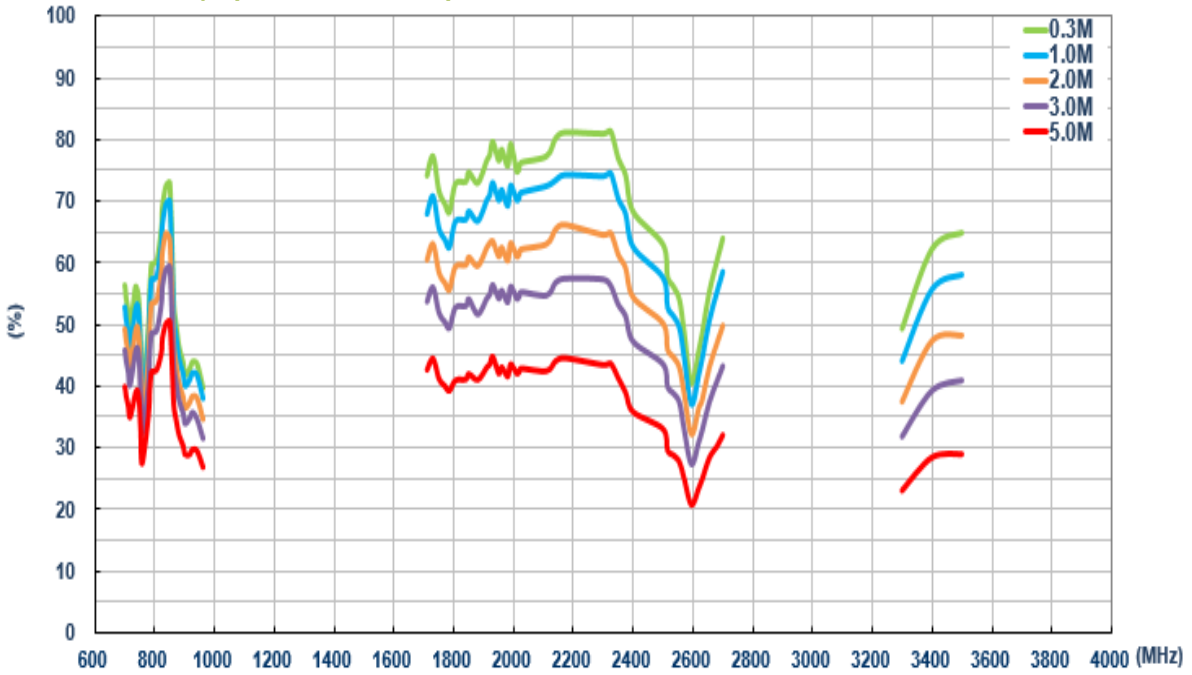

6.1.5 Efficiency (LTE MIMO_2)

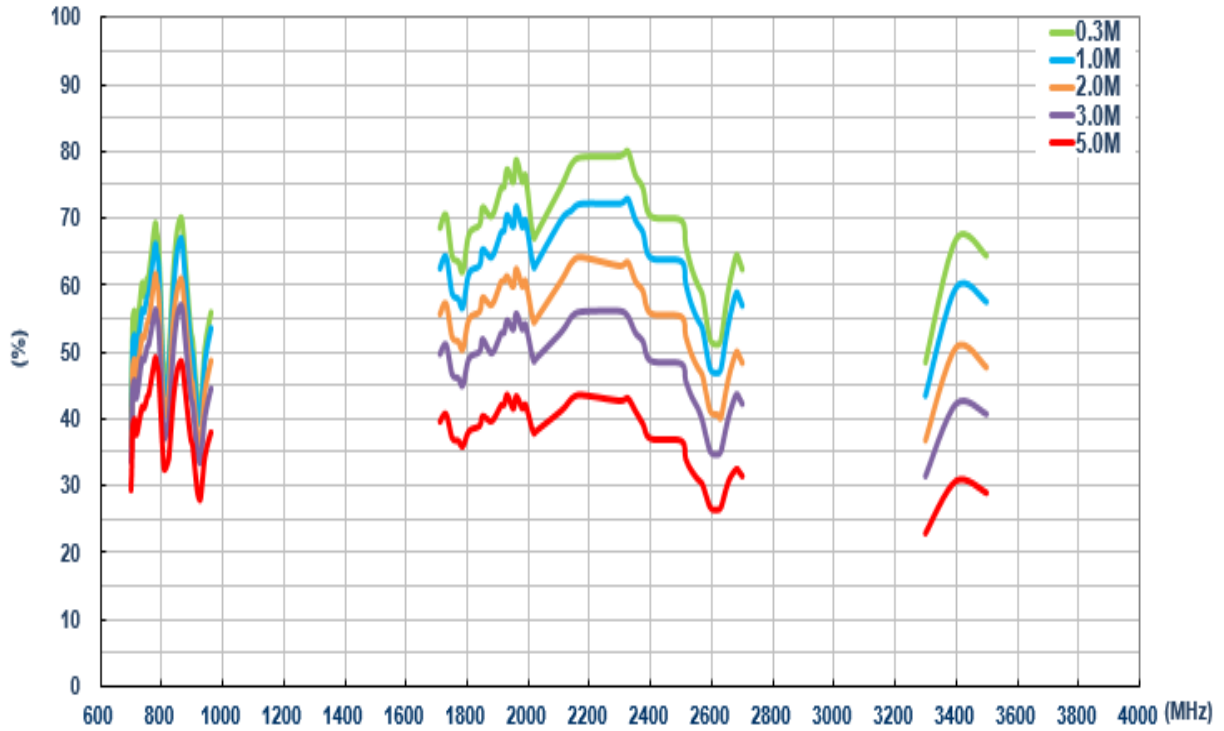

6.1.6 Average Gain (LTE MIMO_1)

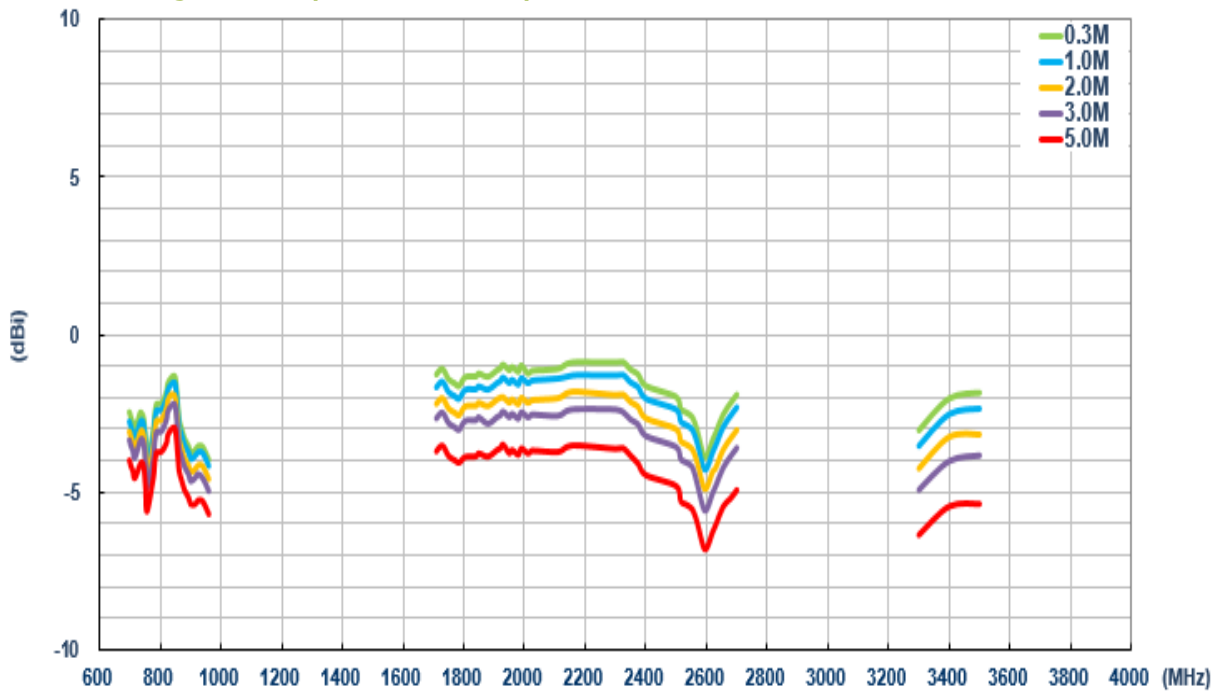

6.1.7 Average Gain (LTE MIMO_2)

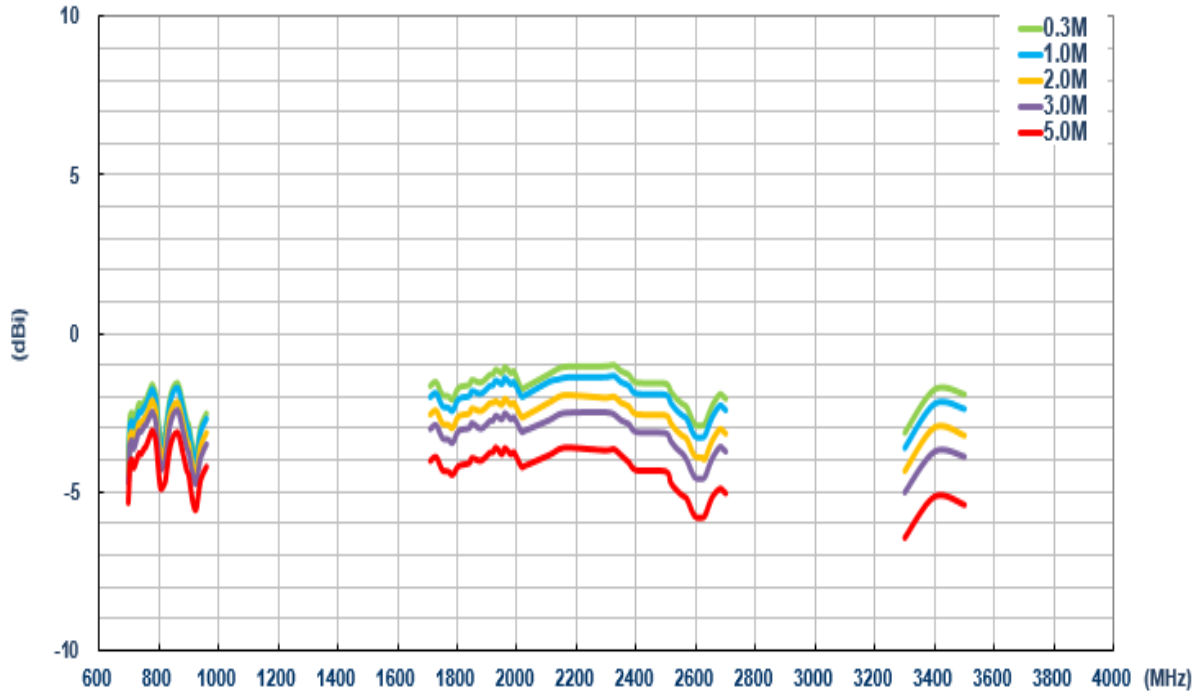

6.1.8 Peak Gain (LTE MIMO_1)

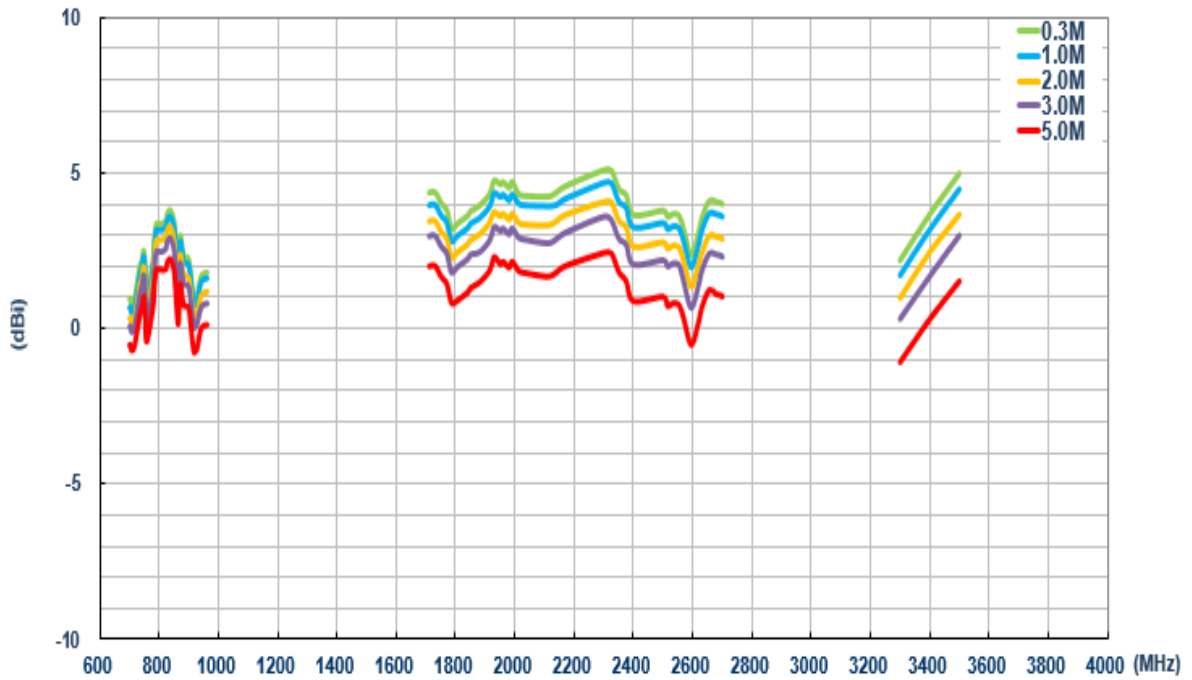

6.1.9 Peak Gain (LTE MIMO_2)

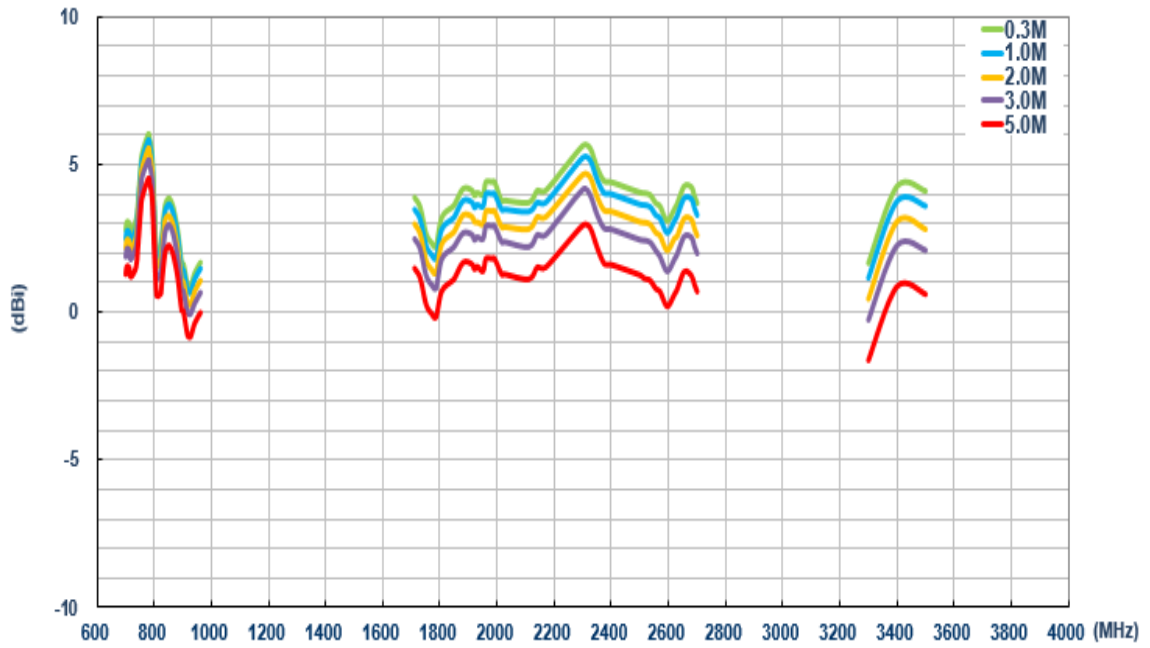

6.2 In free space (Wi-Fi)

6.2.1 Return Loss (Wi-Fi_MIMO_1)

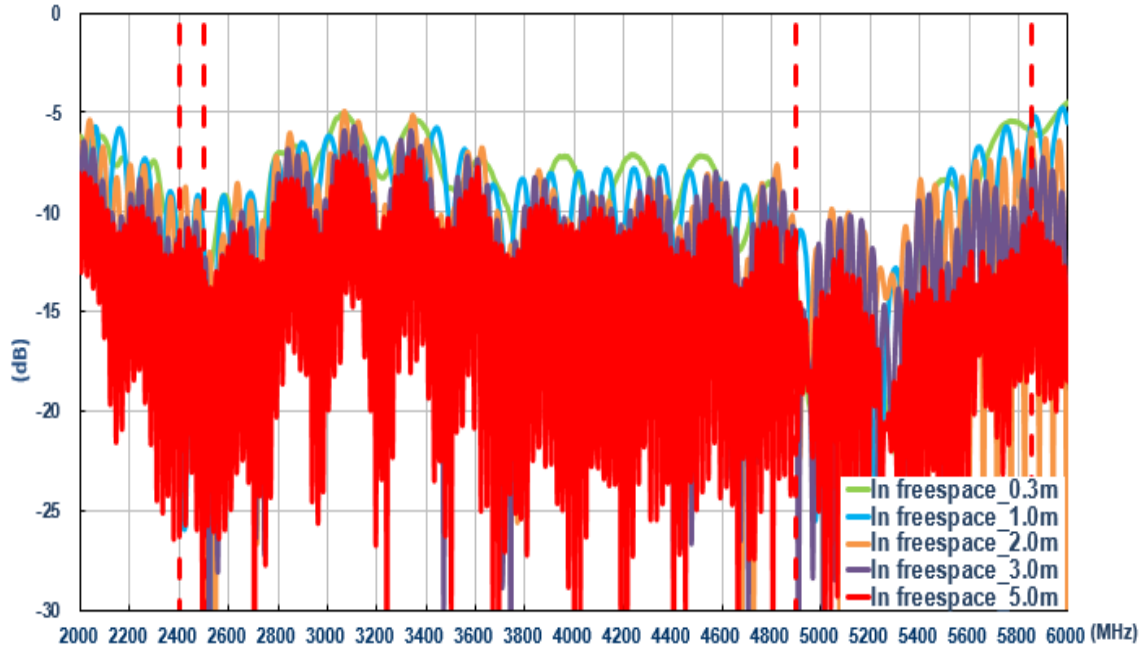

6.2.2 Return Loss (Wi-Fi_MIMO_2)

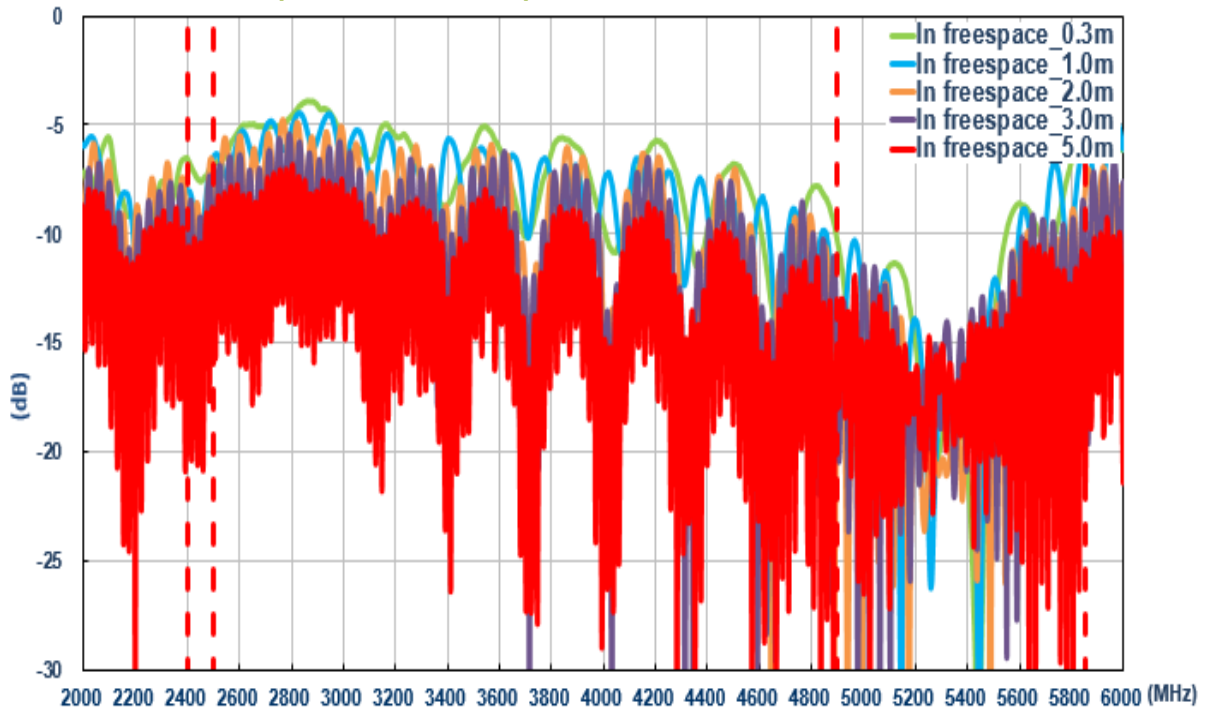

6.2.3 Isolation (Wi-Fi)

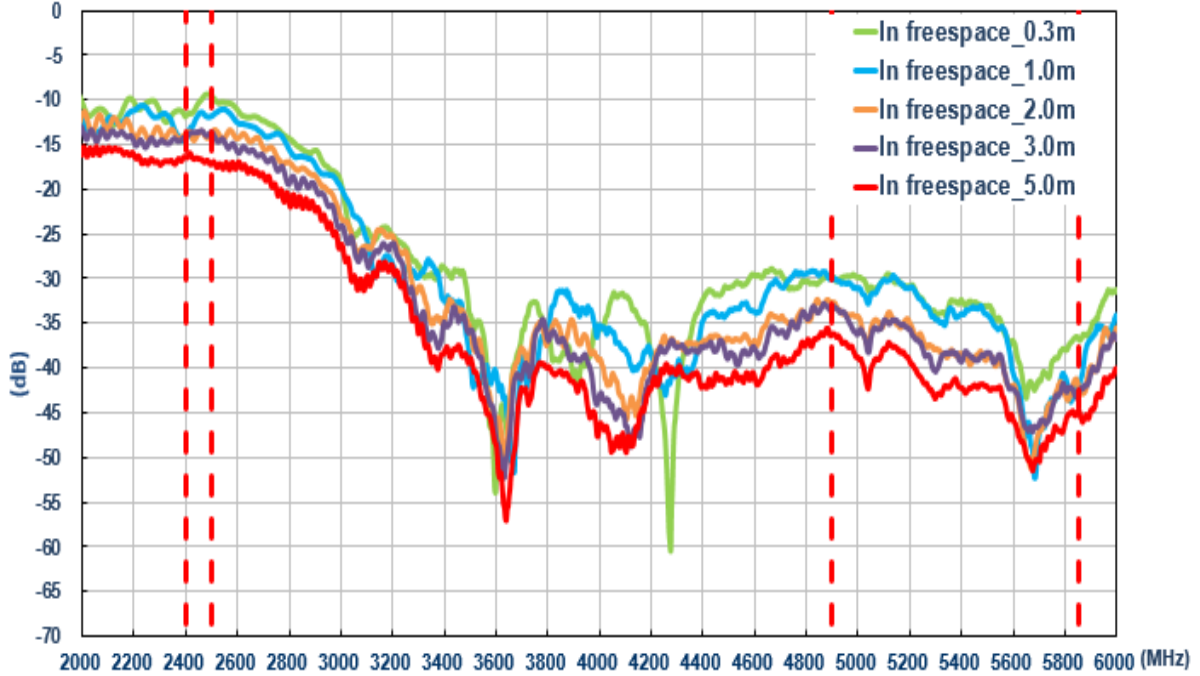

6.2.4 Efficiency (Wi-Fi MIMO_1)

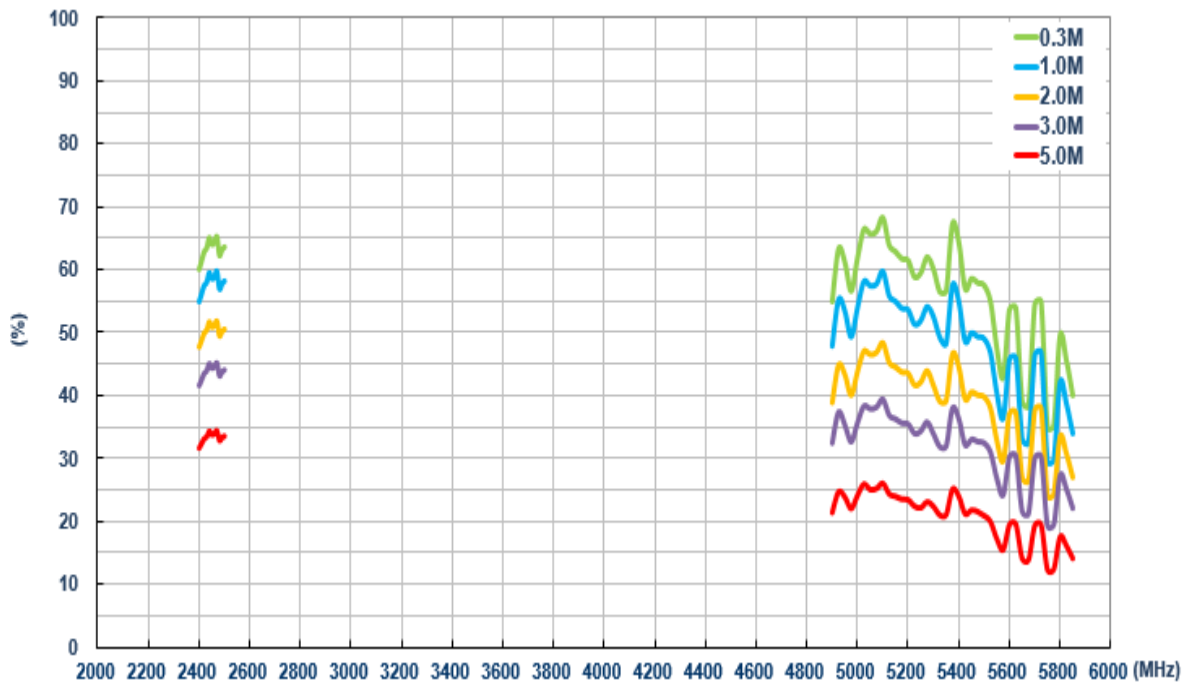

6.2.5 Efficiency (Wi-Fi MIMO_2)

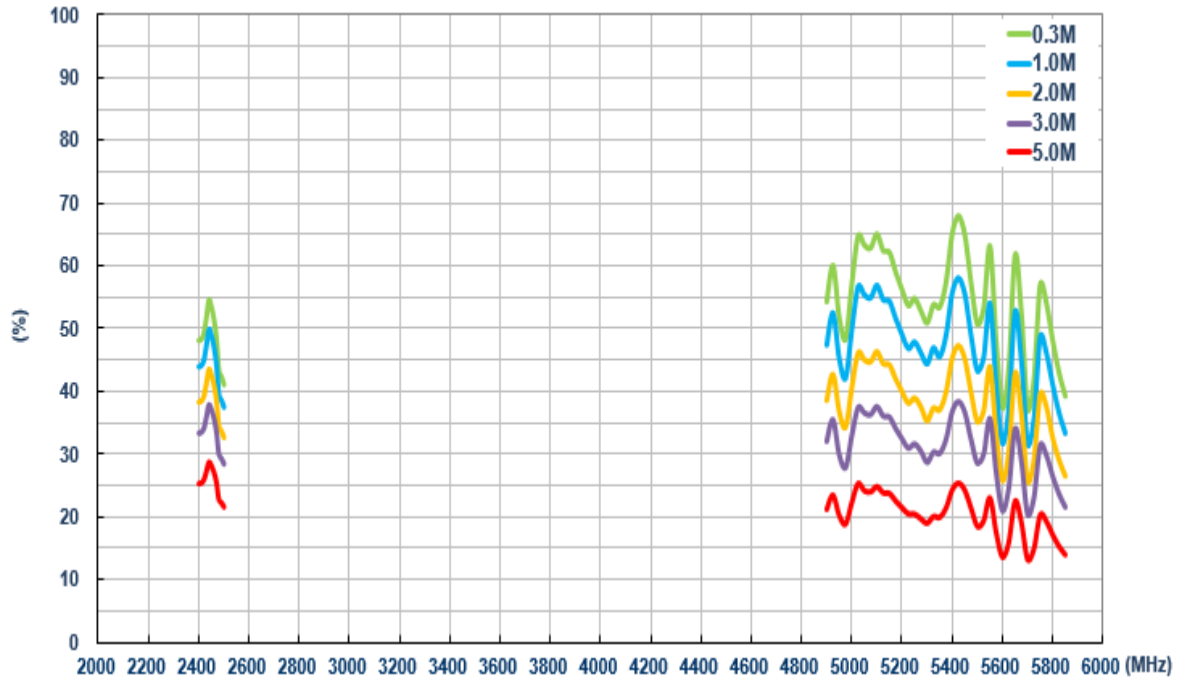

6.2.6 Average Gain (Wi-Fi MIMO_1)

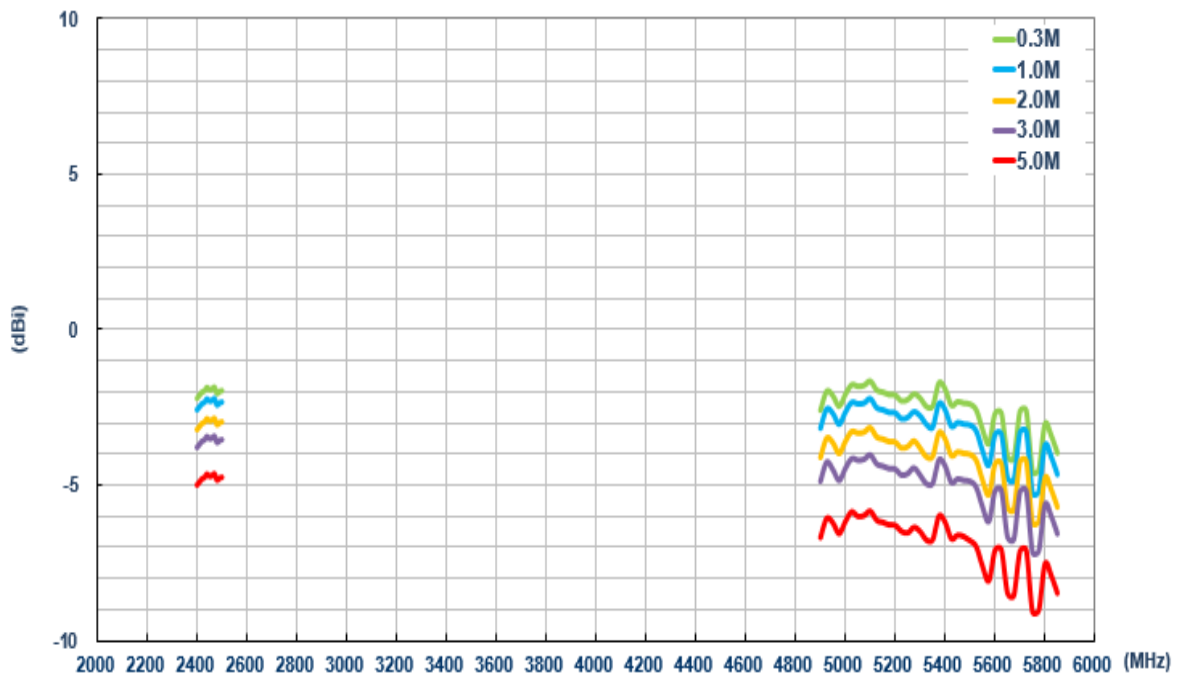

6.2.7 Average Gain (Wi-Fi MIMO_2)

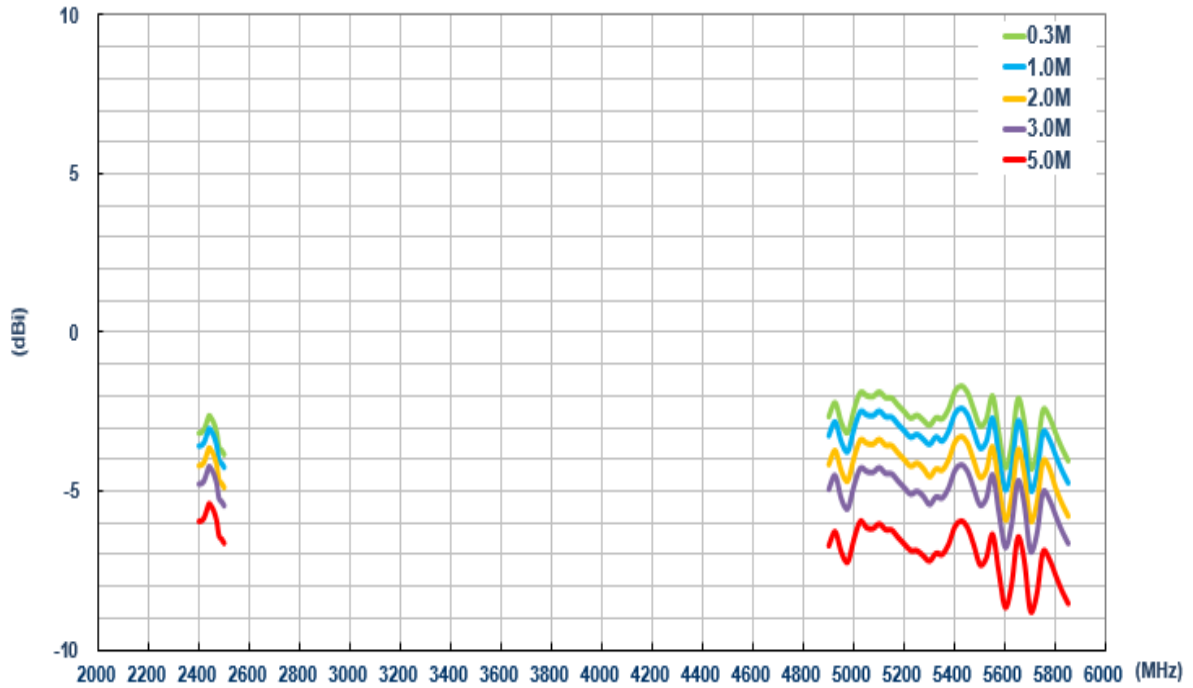

6.2.8 Peak Gain (Wi-Fi MIMO_1)

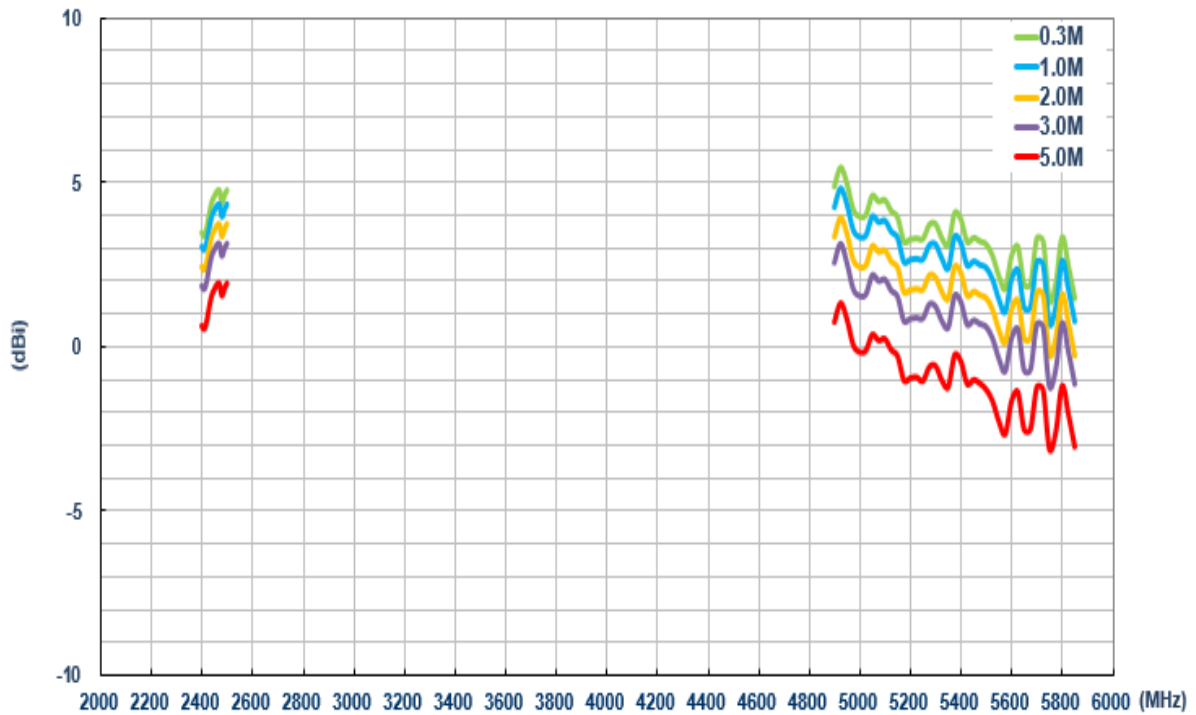

6.2.9 Peak Gain (Wi-Fi MIMO_2)

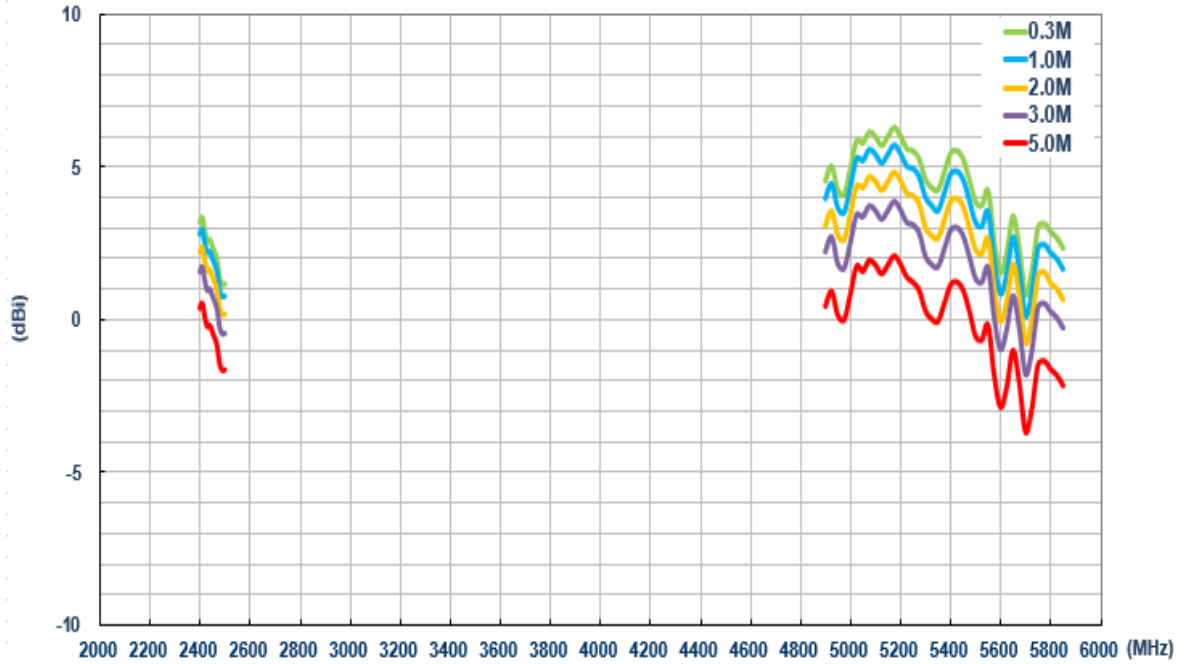

6.3 On the ABS (LTE)

6.3.1 Return Loss (LTE_MIMO_1)

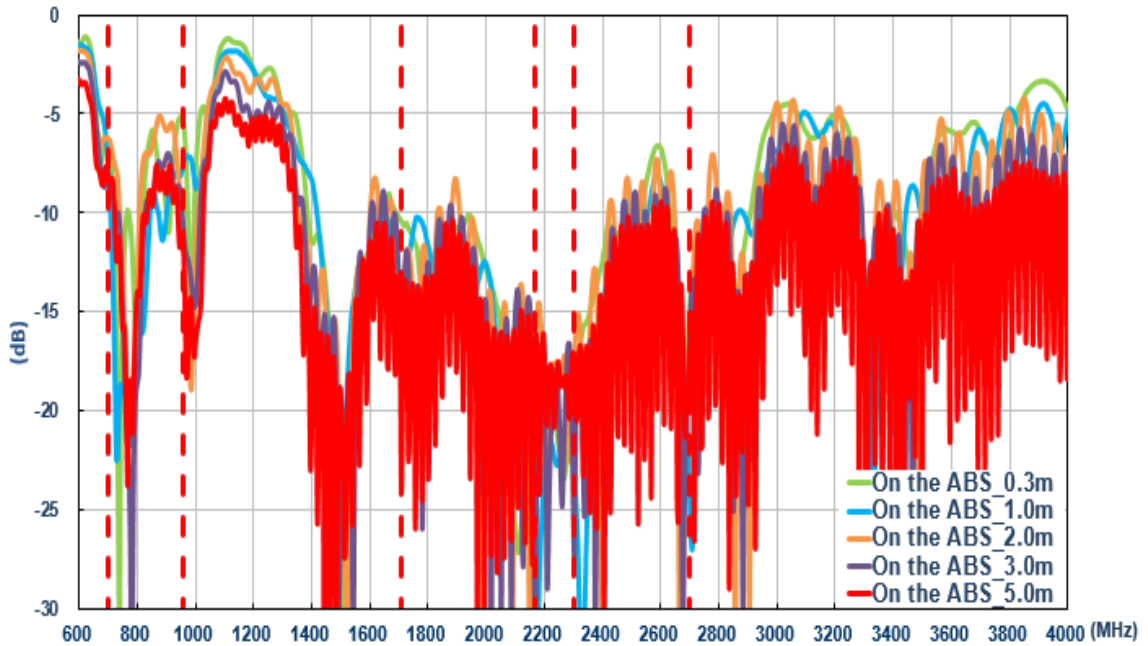

6.3.2 Return Loss (LTE_MIMO_2)

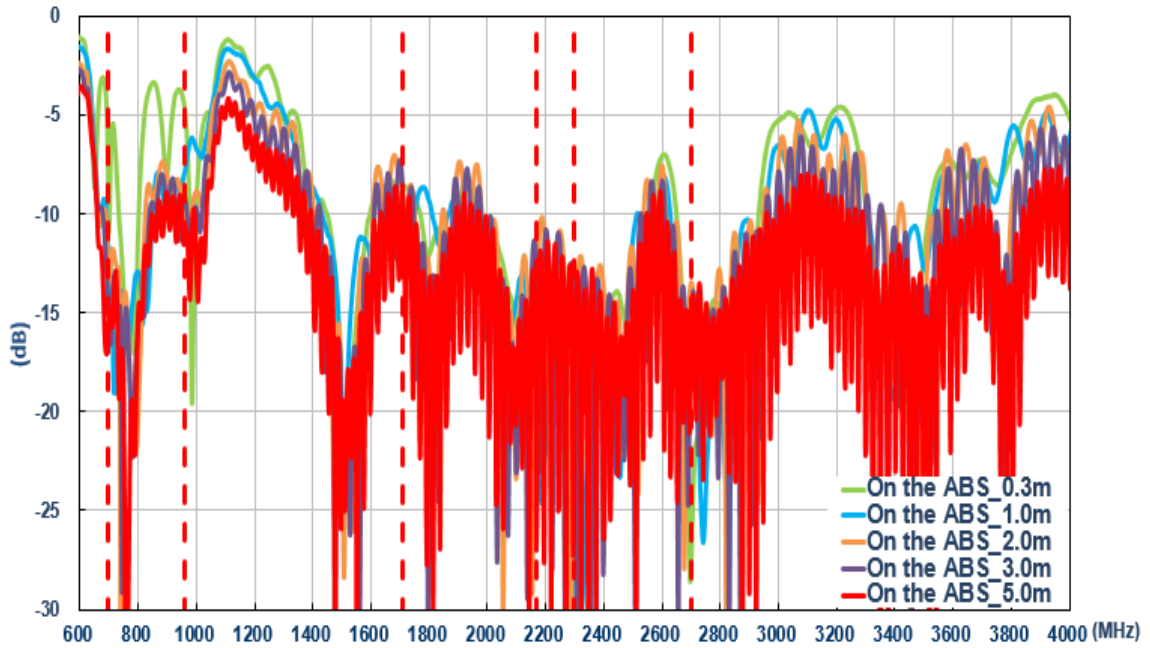

6.3.3 Isolation (LTE antenna)

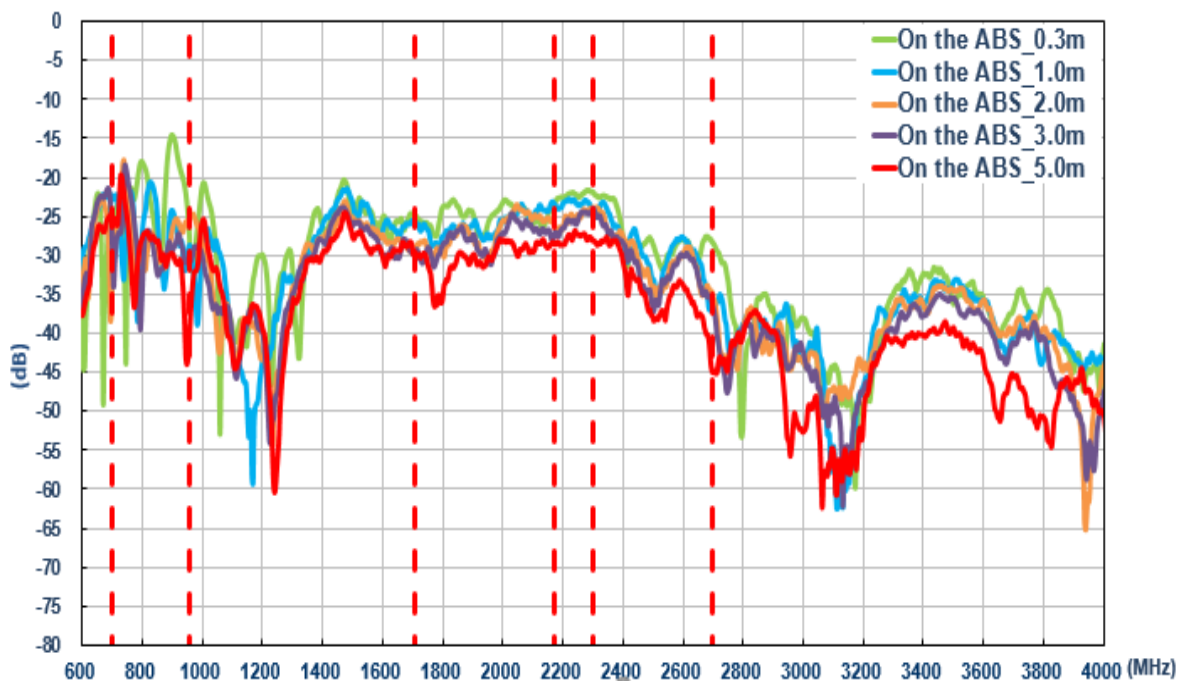

6.3.4 Efficiency (LTE MIMO_1)

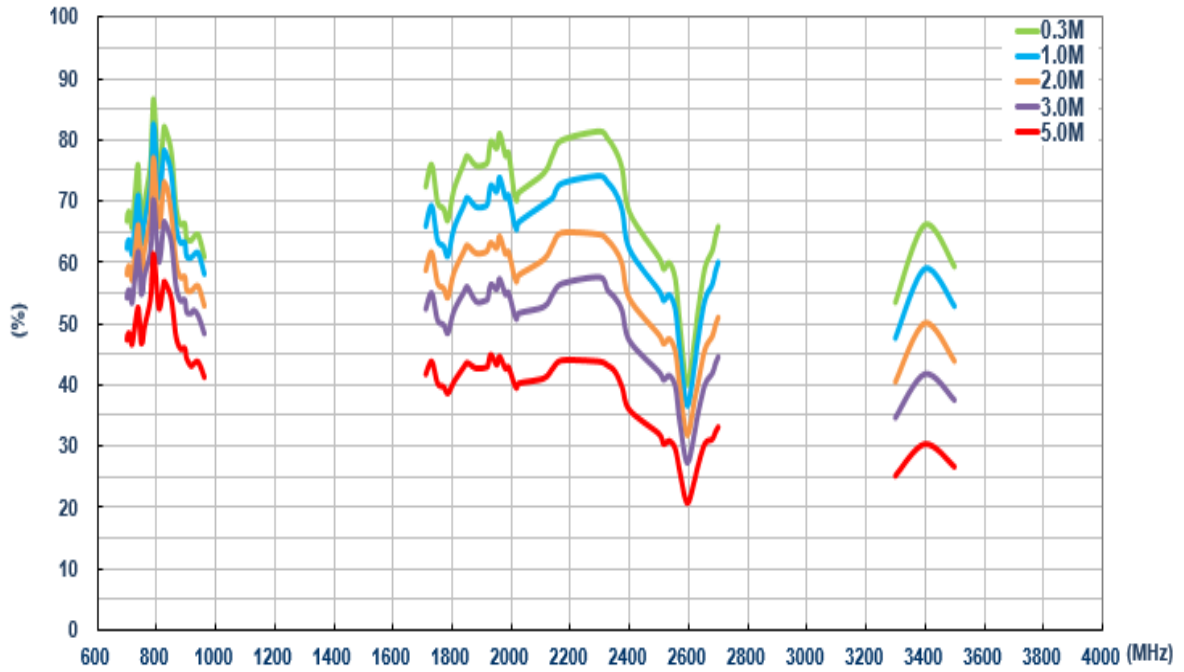

6.3.5 Efficiency (LTE MIMO_2)

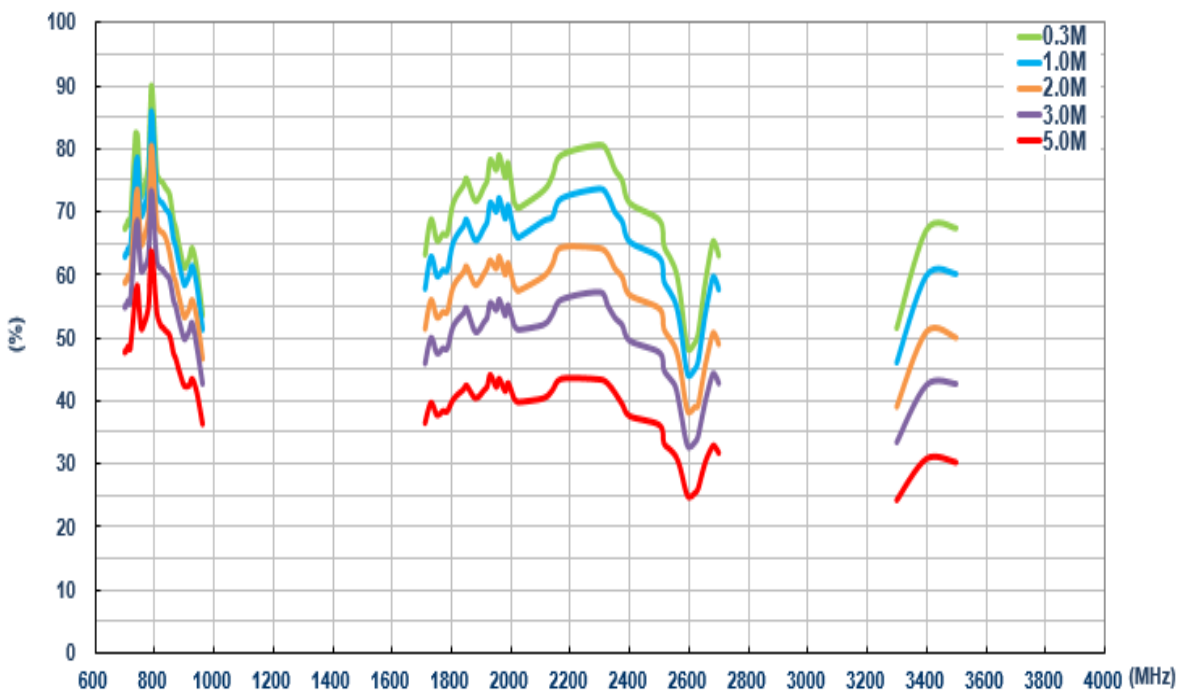

6.3.6 Average Gain (LTE MIMO_1)

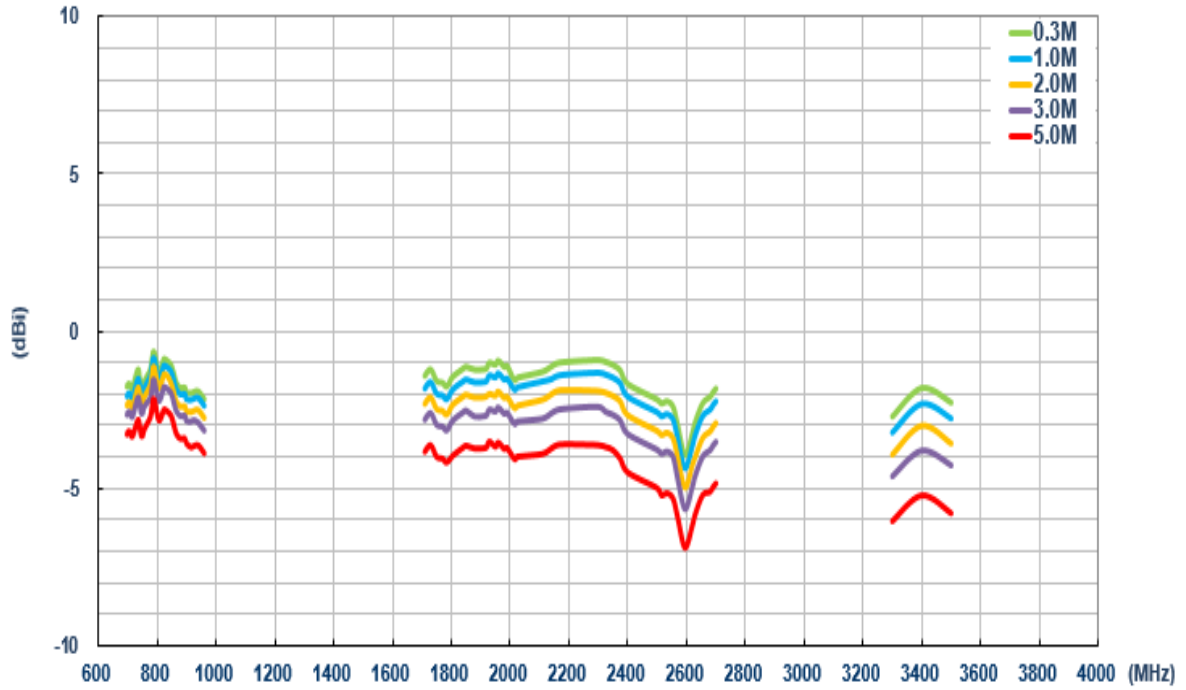

6.3.7 Average Gain (LTE MIMO_2)

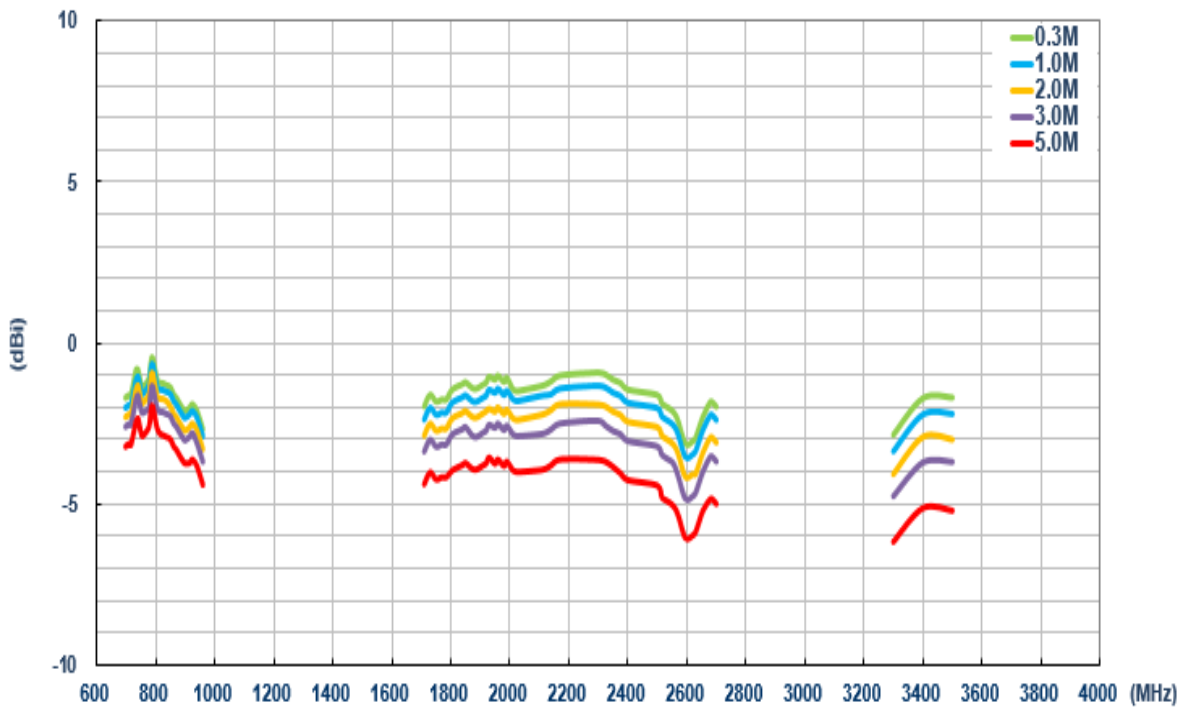

6.3.8 Peak Gain (LTE MIMO_1)

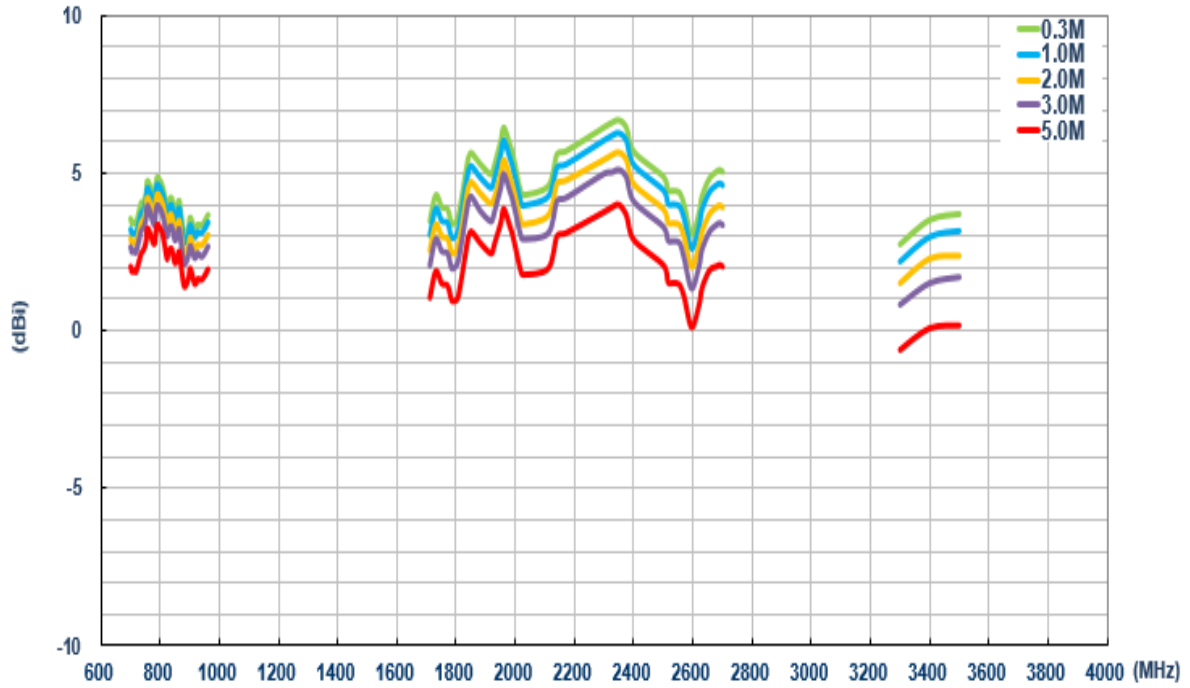

6.3.9 Peak Gain (LTE MIMO_2)

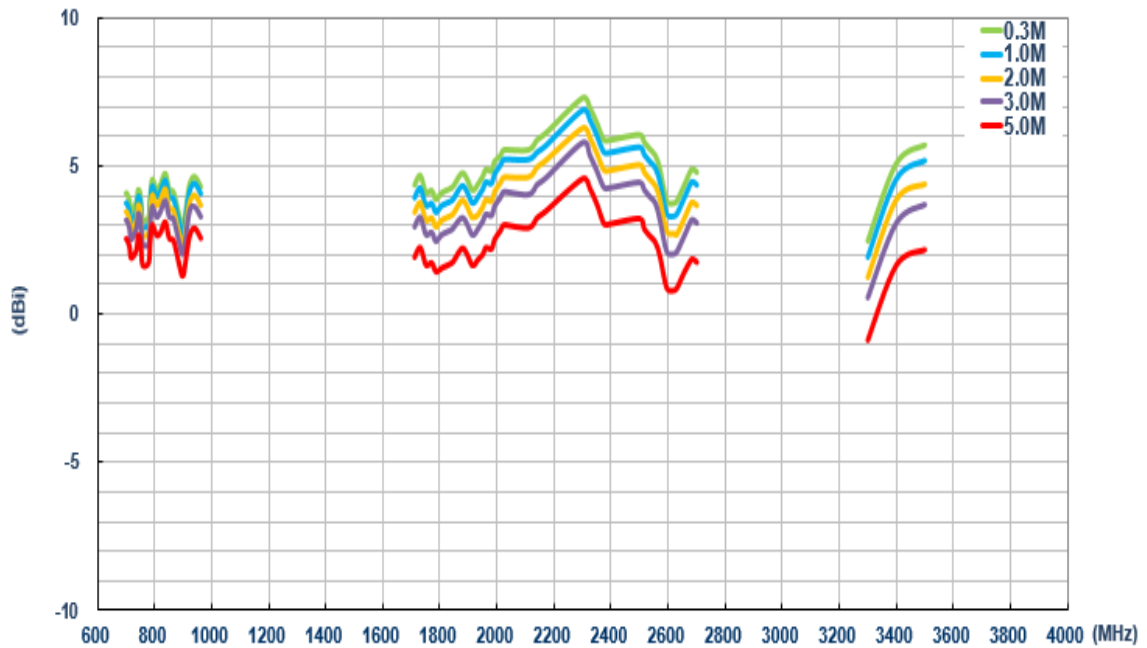

6.4 On ABS (Wi-Fi)

6.4.1 Return Loss (Wi-Fi_MIMO_1)

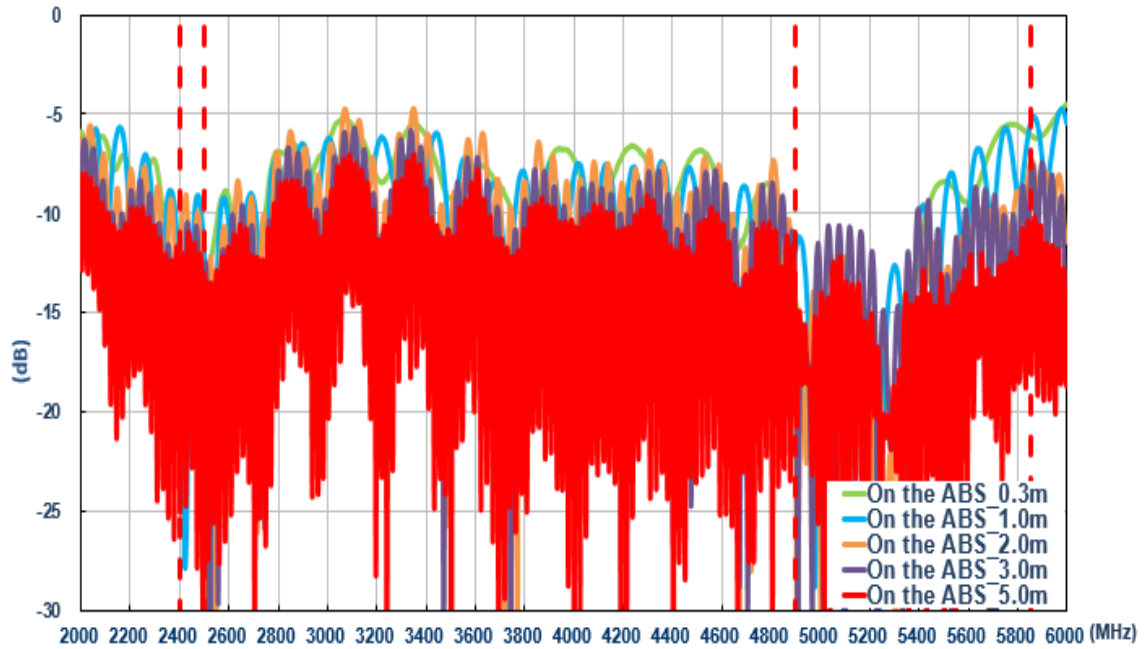

6.4.2 Return Loss (Wi-Fi_MIMO_2)

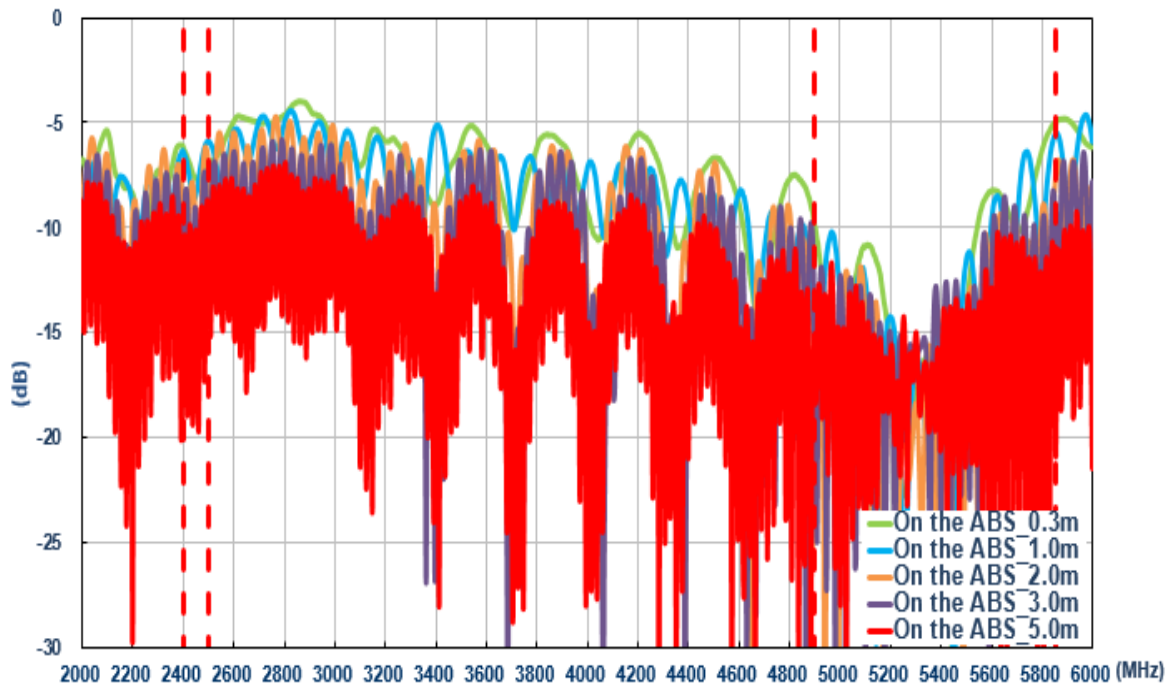

6.4.3 Isolation (Wi-Fi)

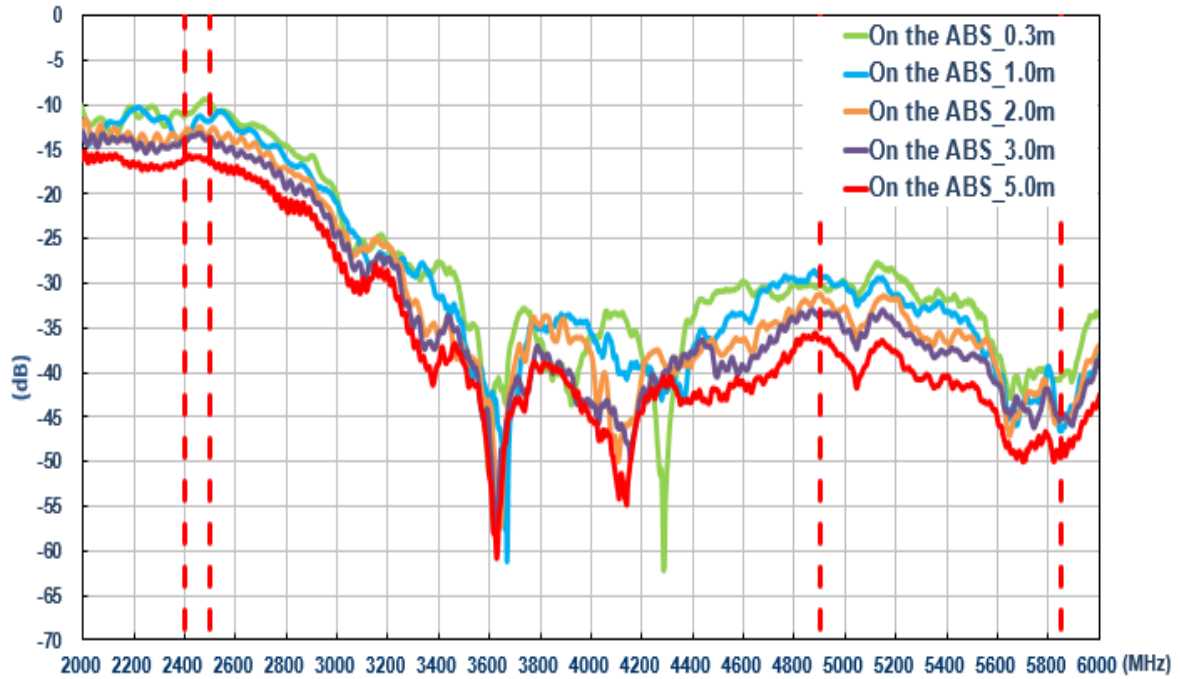

6.4.4 Efficiency (Wi-Fi MIMO_1)

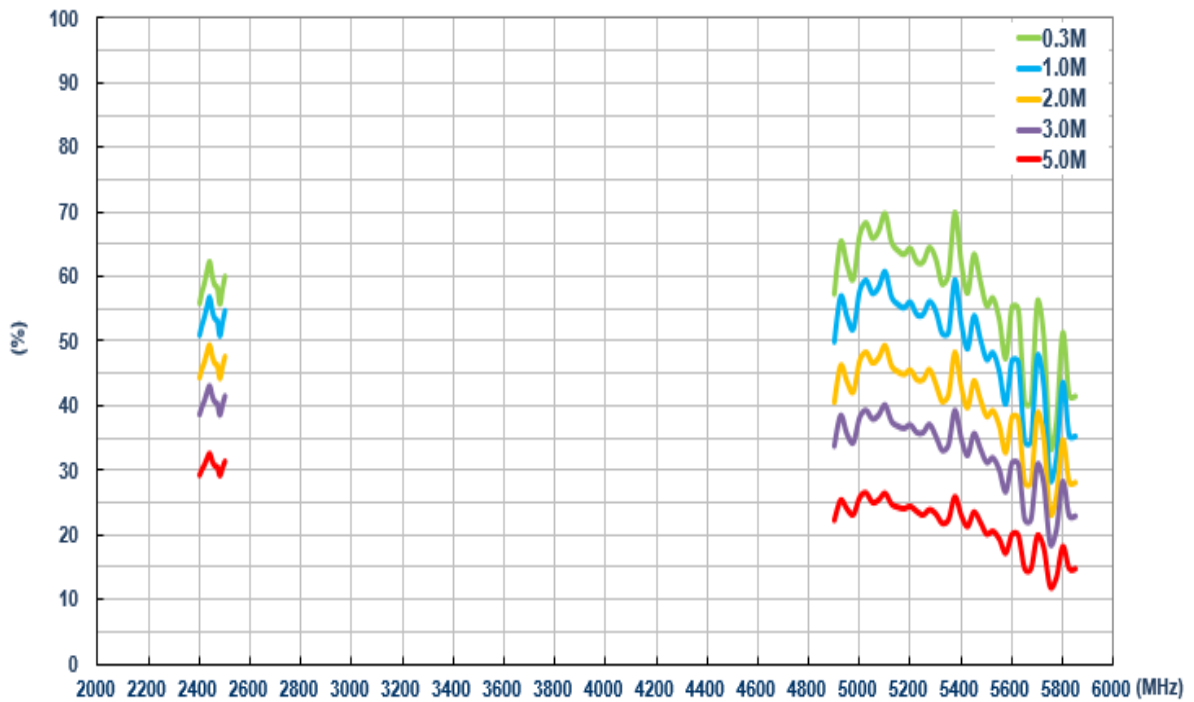

6.4.5 Efficiency (Wi-Fi MIMO_2)

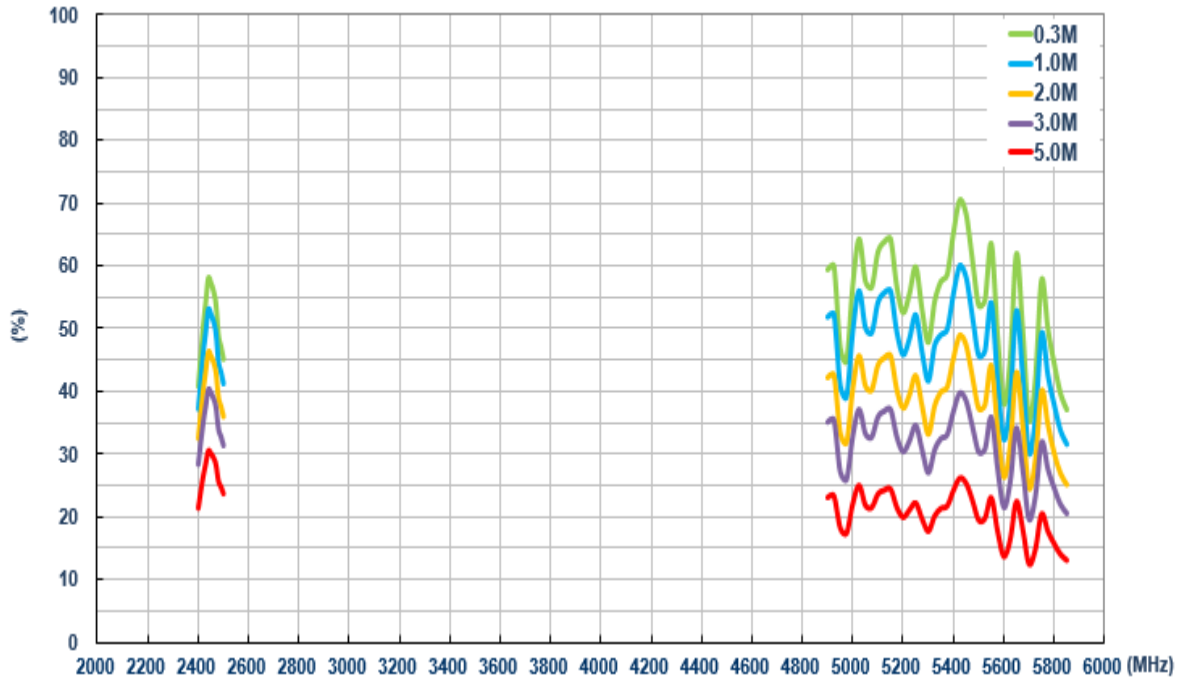

6.4.6 Average Gain (Wi-Fi MIMO_1)

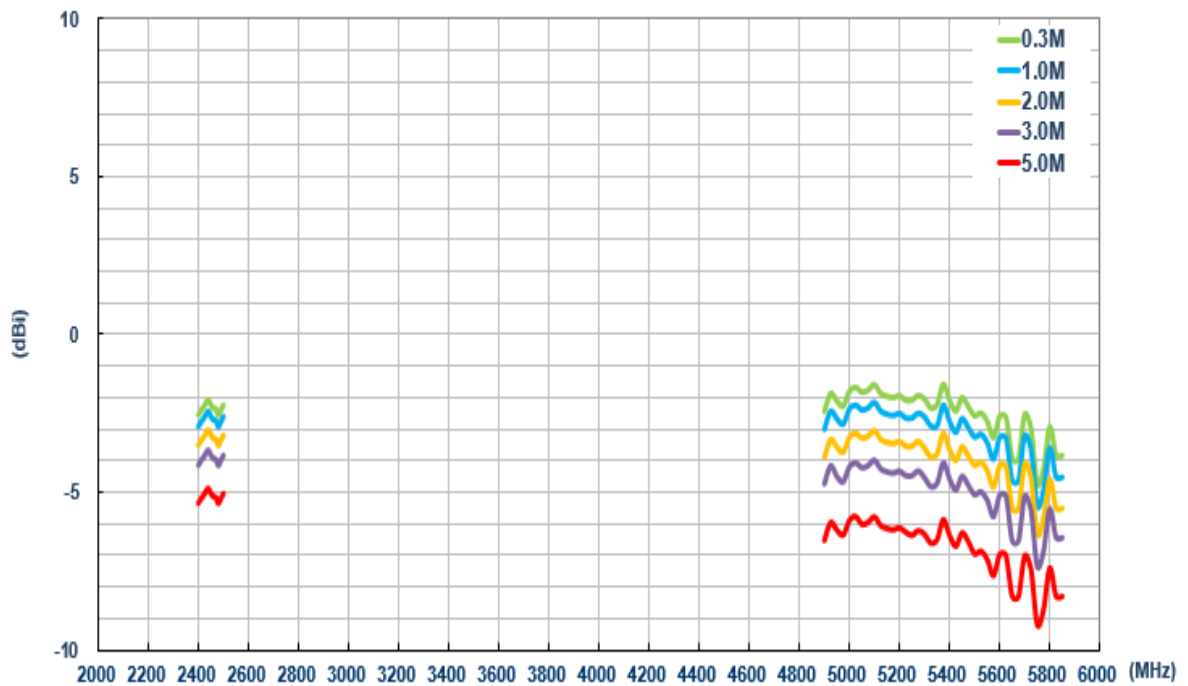

6.4.7 Average Gain (Wi-Fi MIMO_2)

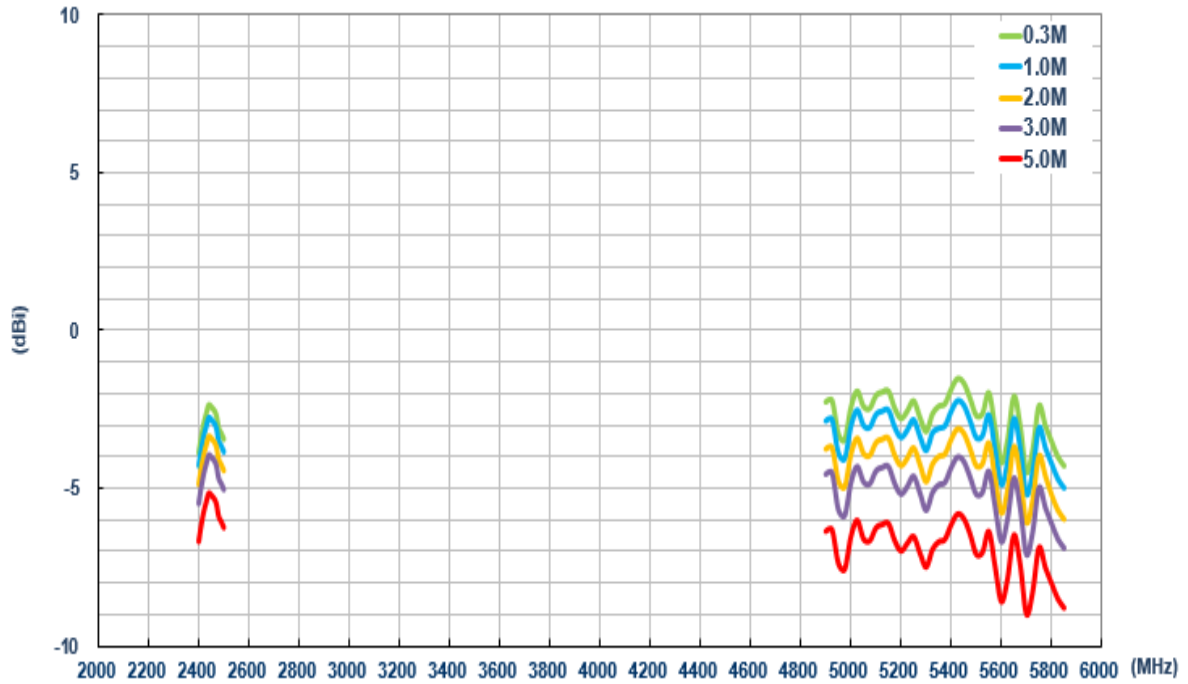

6.4.8 Peak Gain (Wi-Fi MIMO_1)

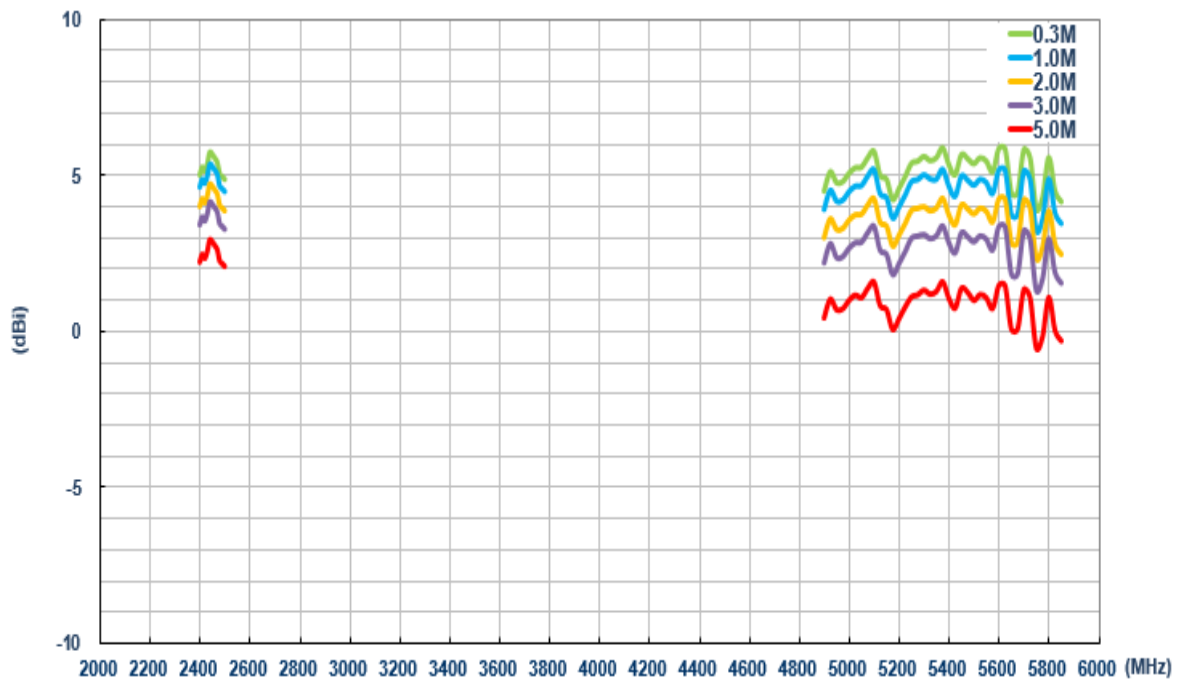

6.4.9 Peak Gain (Wi-Fi MIMO_2)

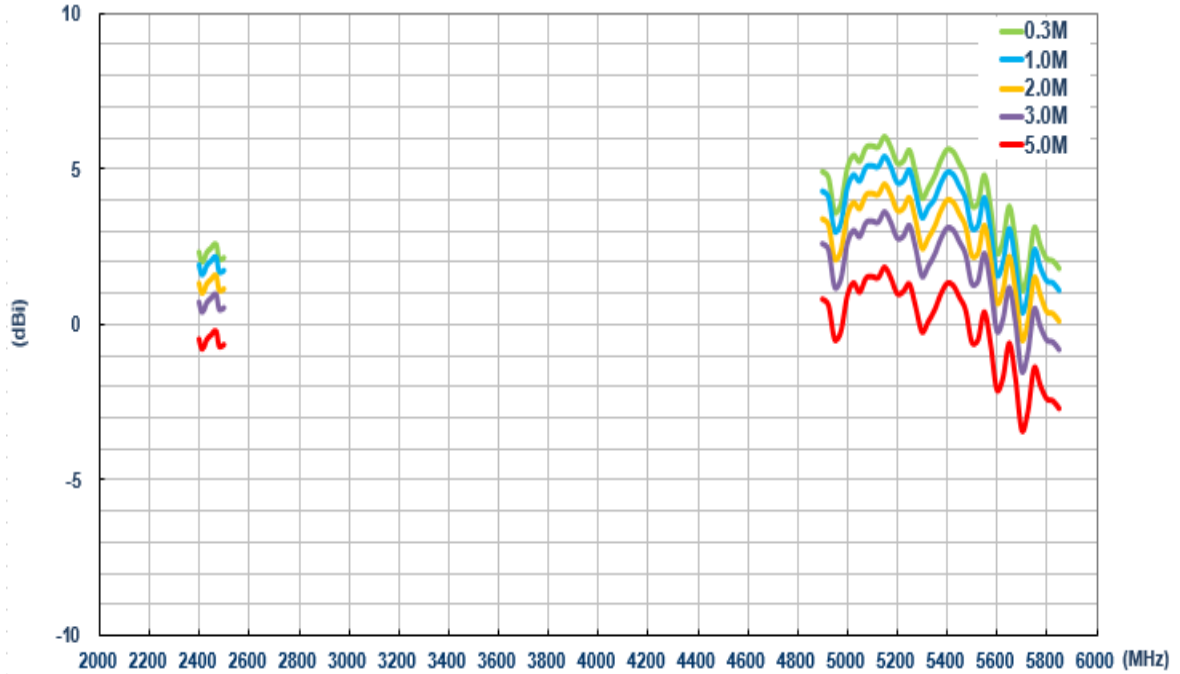

6.5 On glass (LTE)

6.5.1 Return Loss (LTE_MIMO_1)

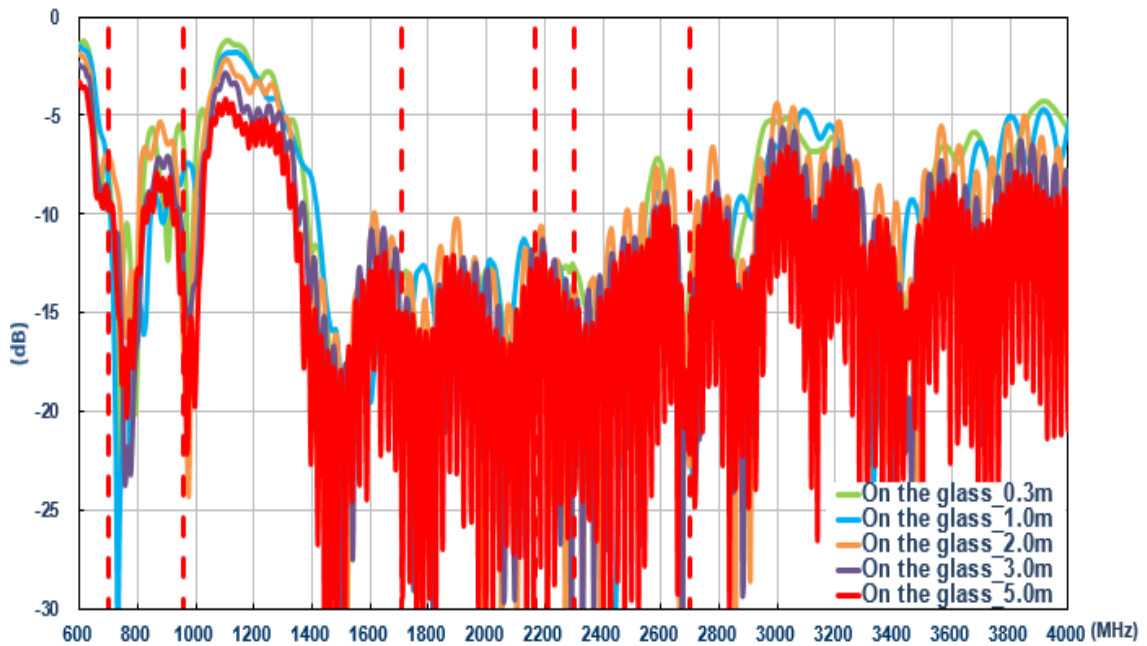

6.5.2 Return Loss (LTE_MIMO_2)

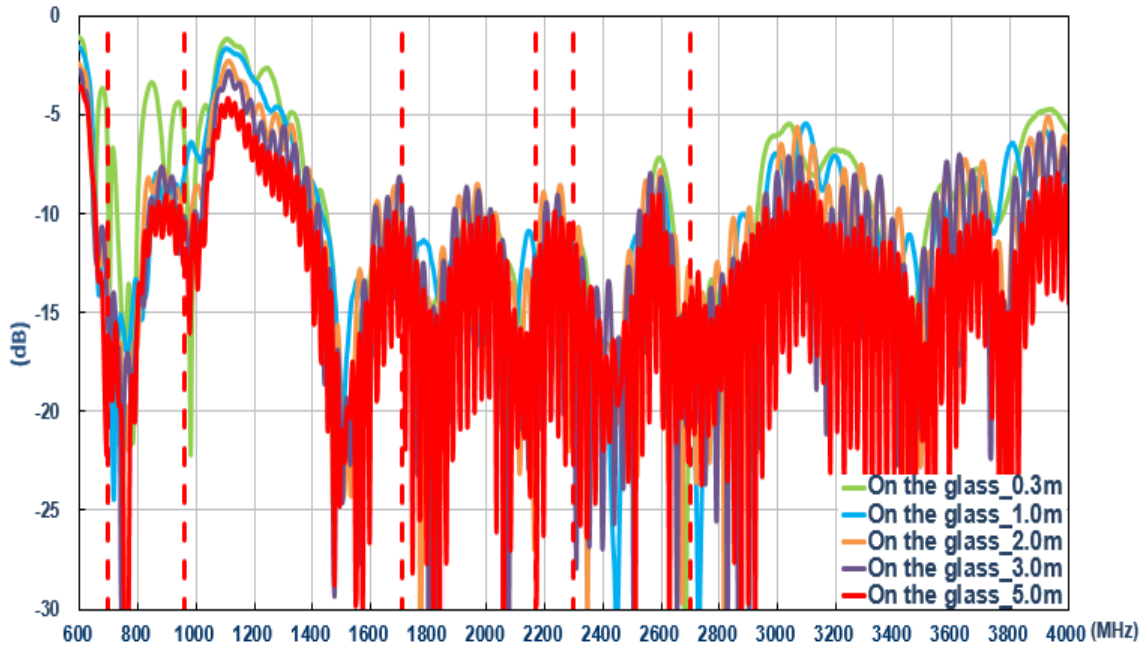

6.5.3 Isolation (LTE antenna)

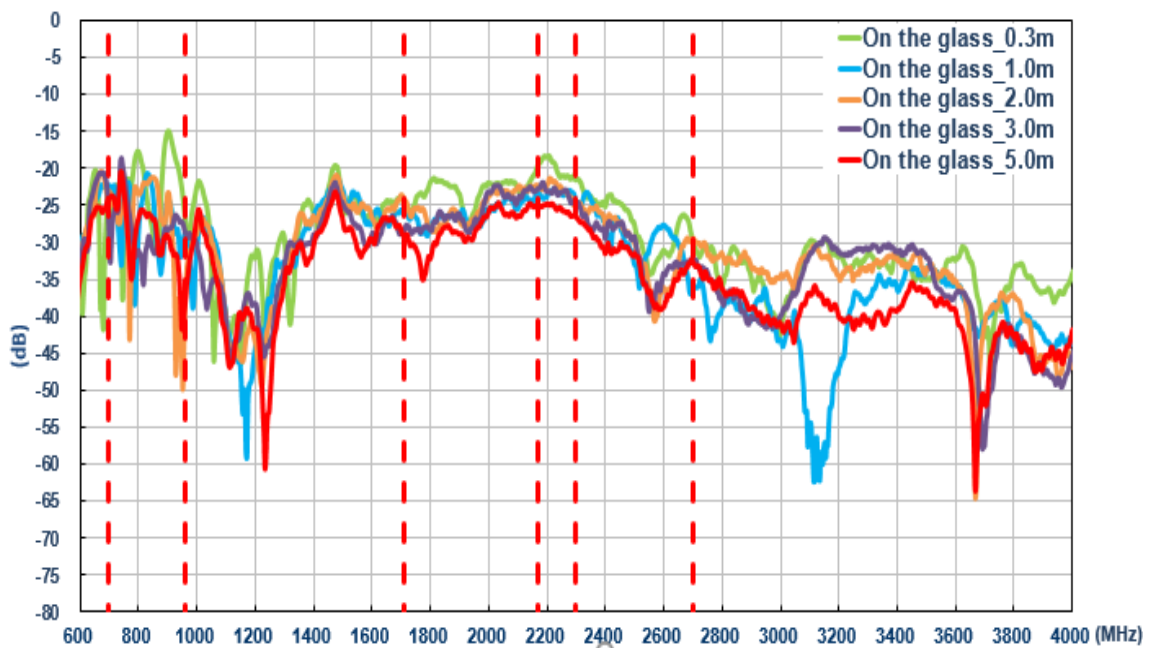

6.5.4 Efficiency (LTE MIMO_1)

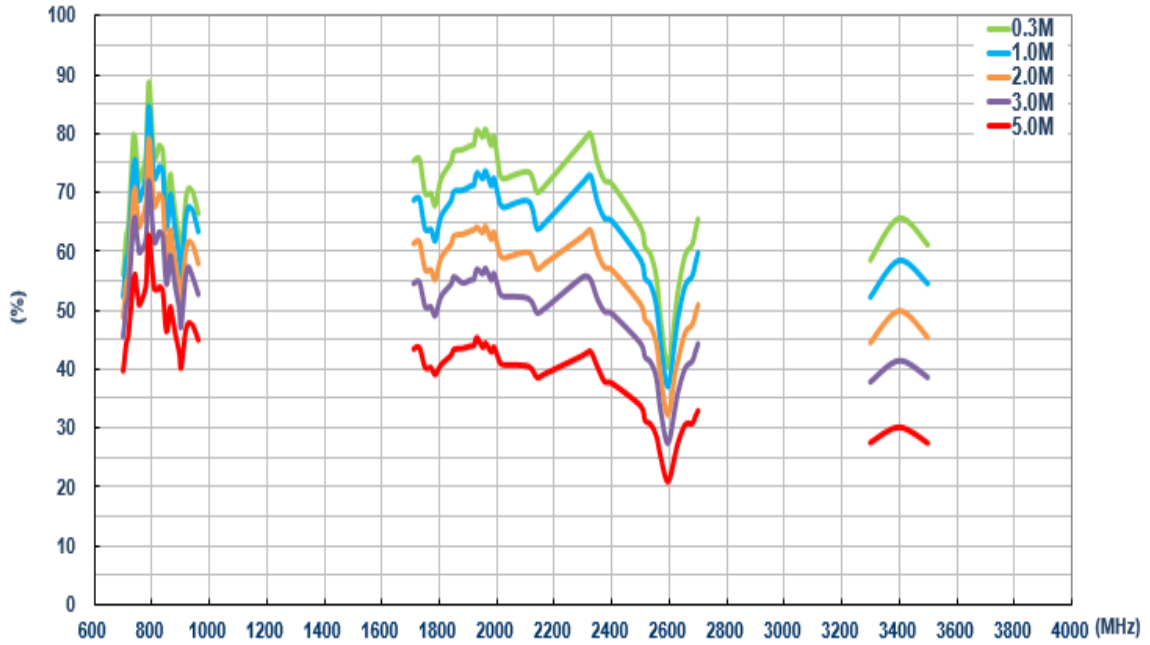

6.5.5 Efficiency (LTE MIMO_2)

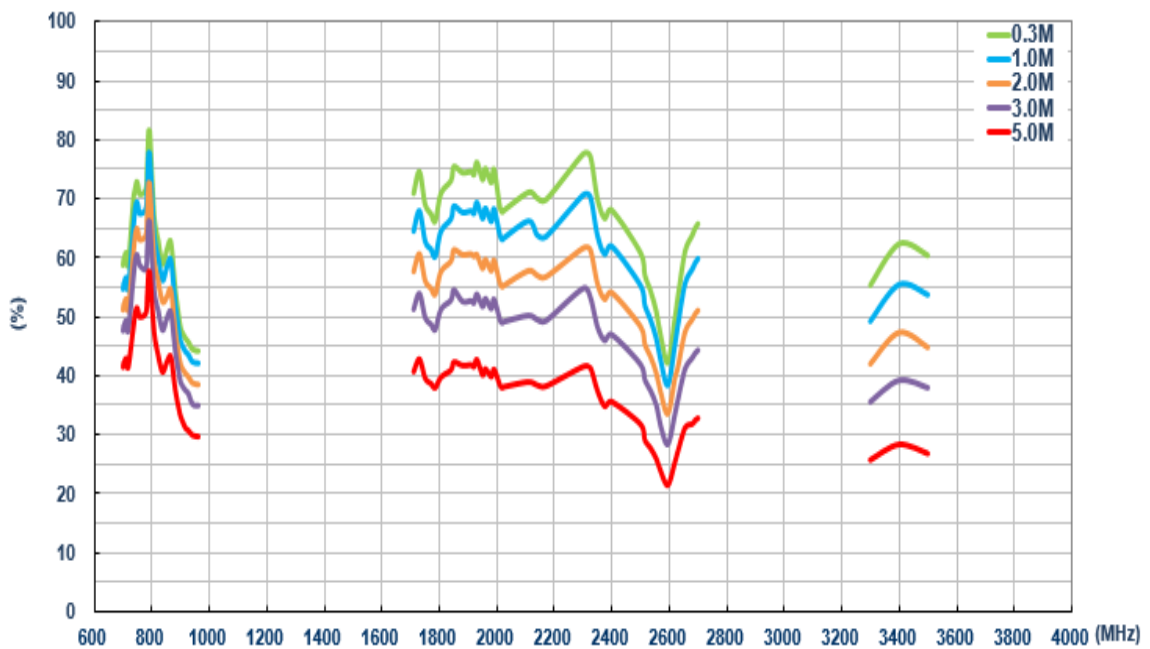

6.5.6 Average Gain (LTE MIMO_1)

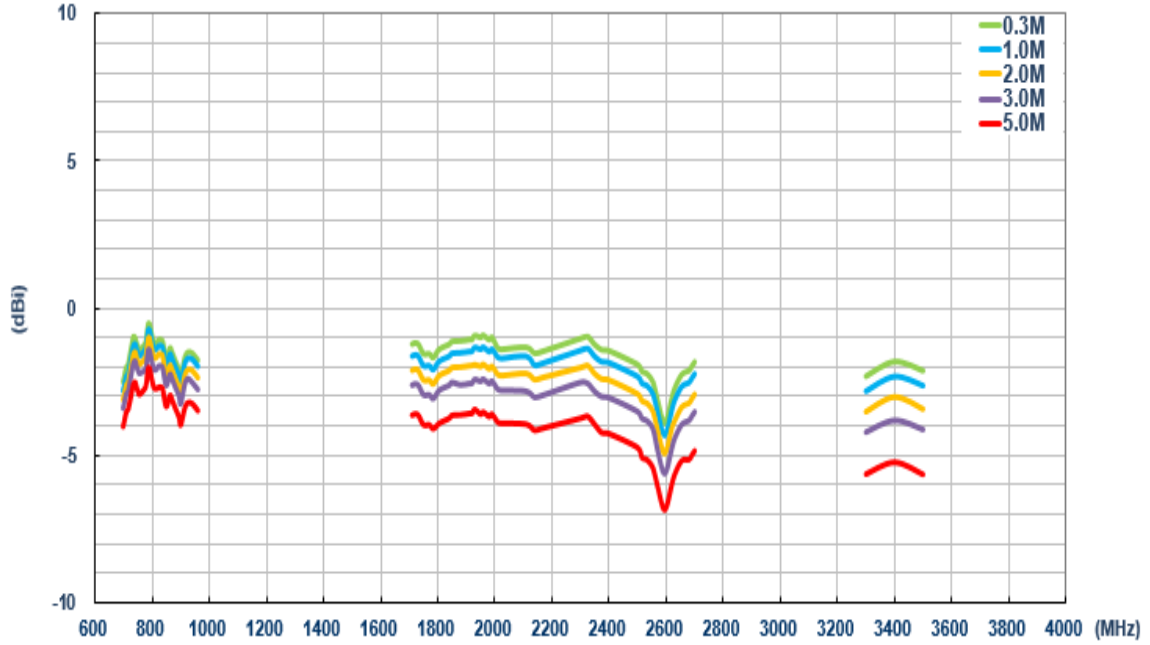

6.5.7 Average Gain (LTE MIMO_2)

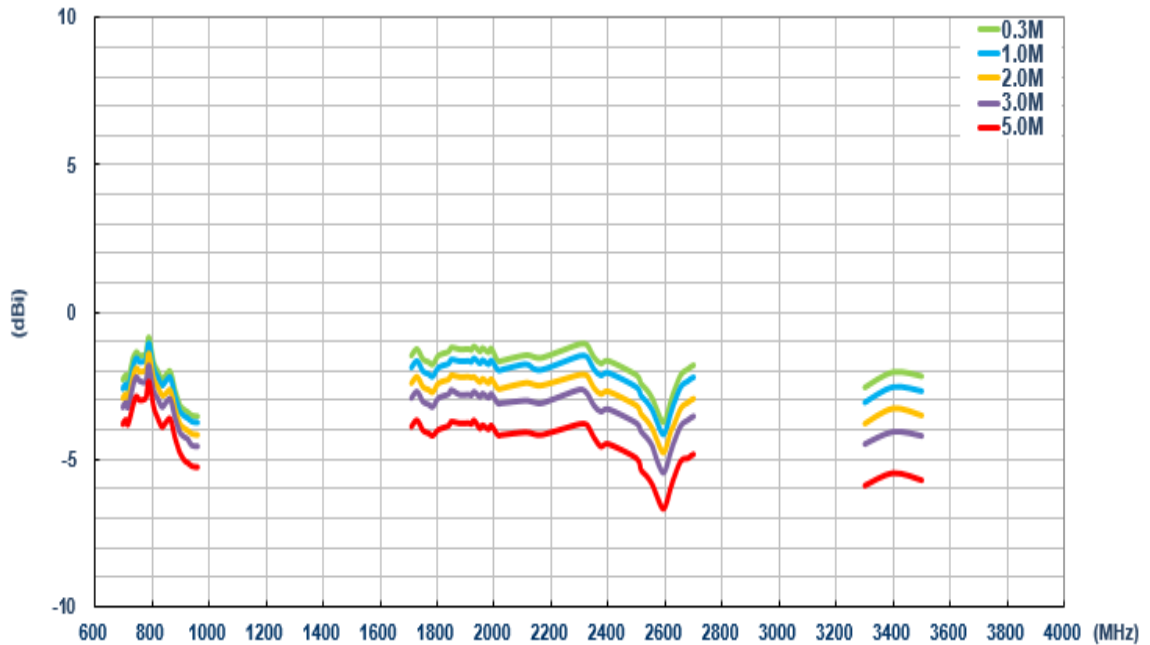

6.5.8 Peak Gain (LTE MIMO_1)

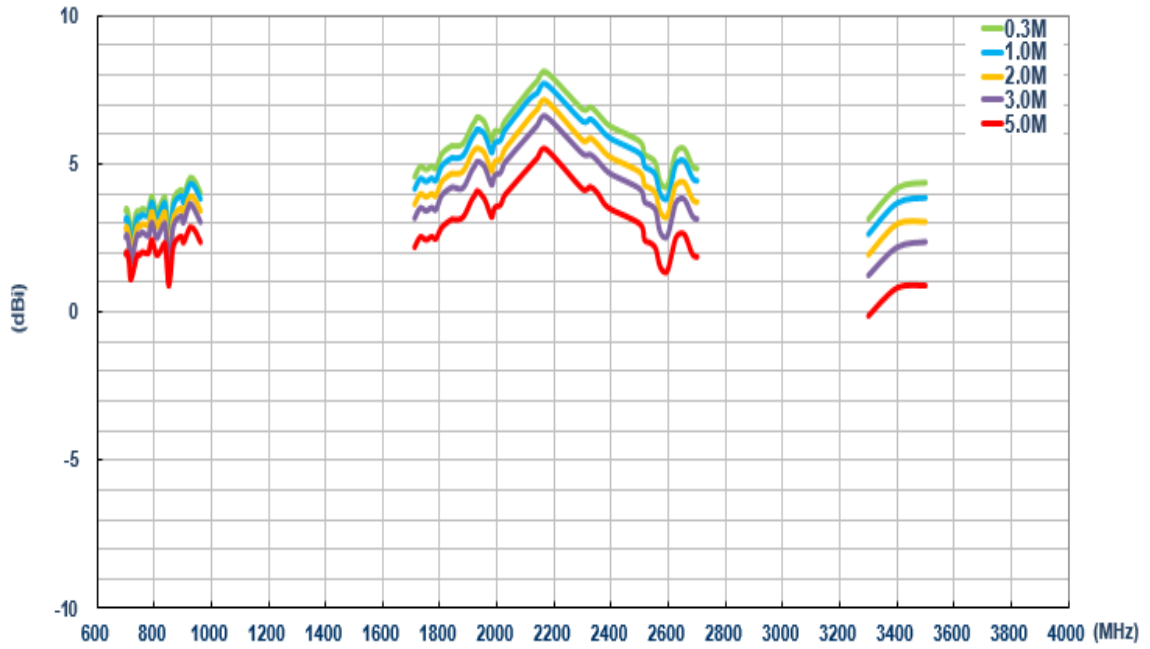

6.5.9 Peak Gain (LTE MIMO_2)

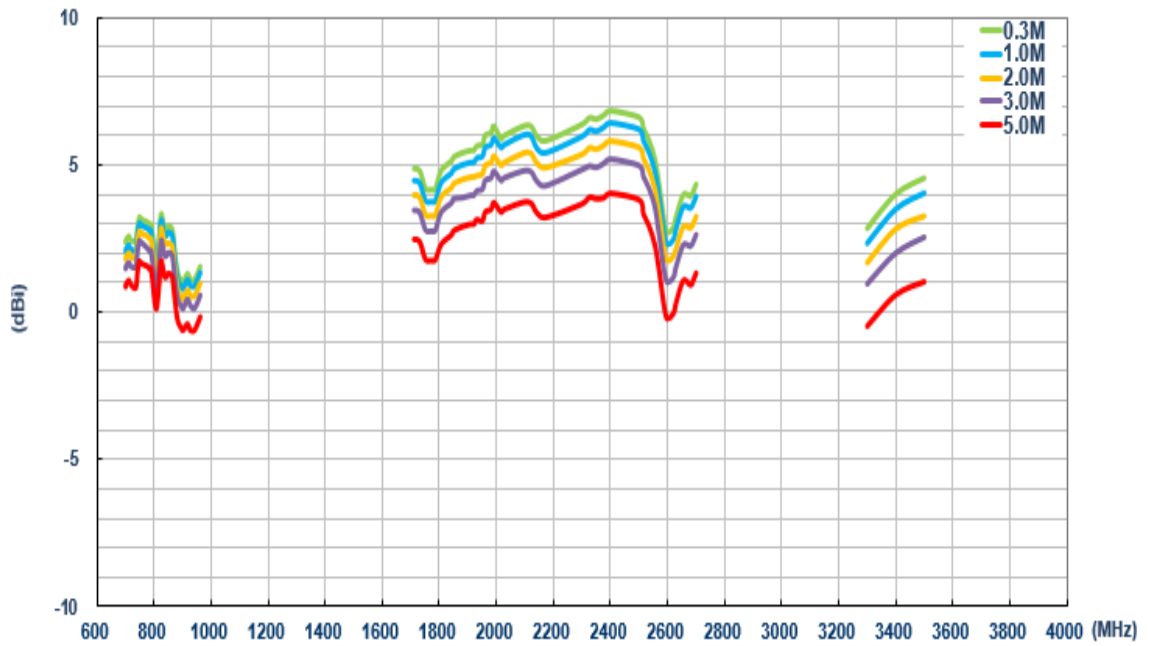

6.6 On glass (Wi-Fi)

6.6.1 Return Loss (Wi-Fi _MIMO_1)

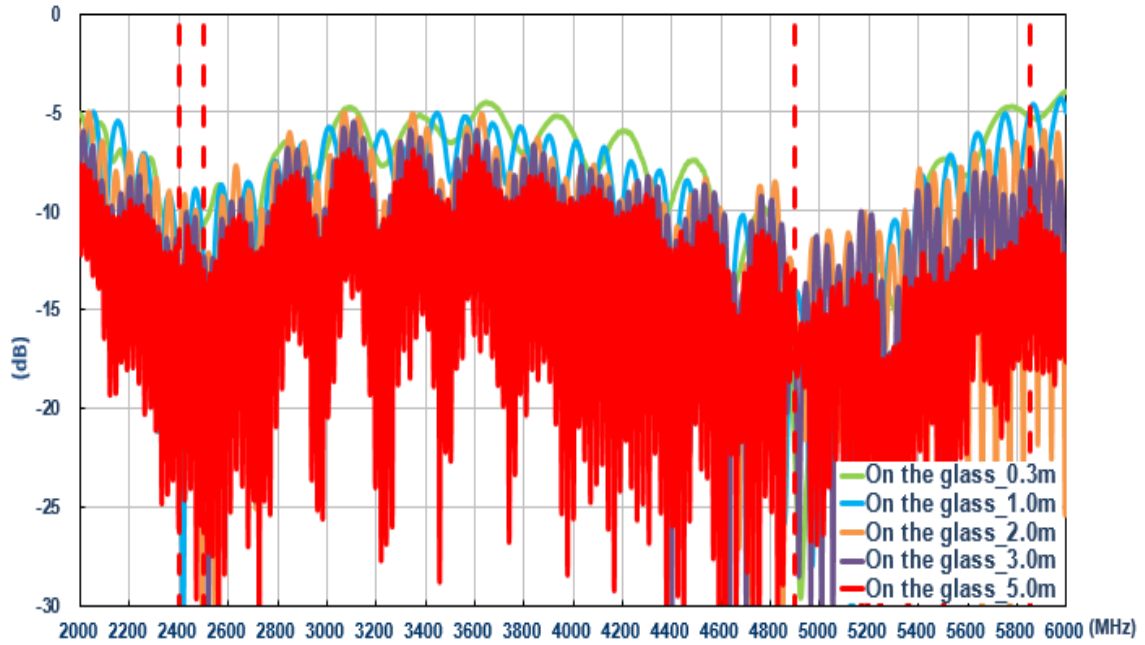

6.6.2 Return Loss (Wi-Fi _MIMO_2)

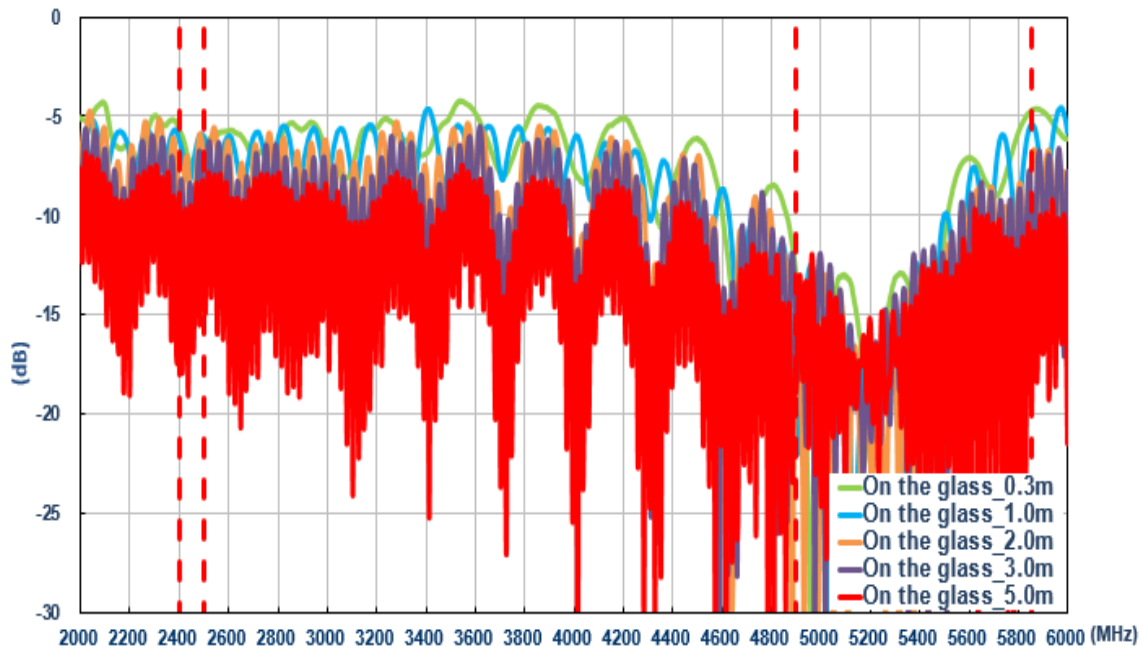

6.6.3 Isolation (Wi-Fi)

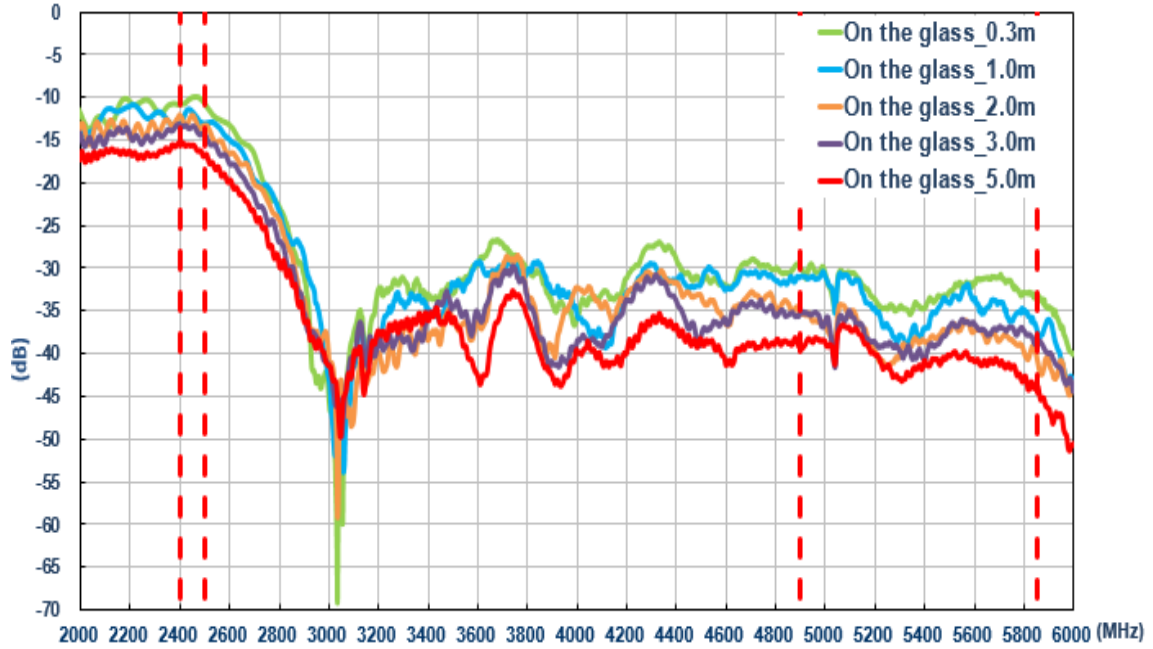

6.6.4 Efficiency (Wi-Fi _MIMO_1)

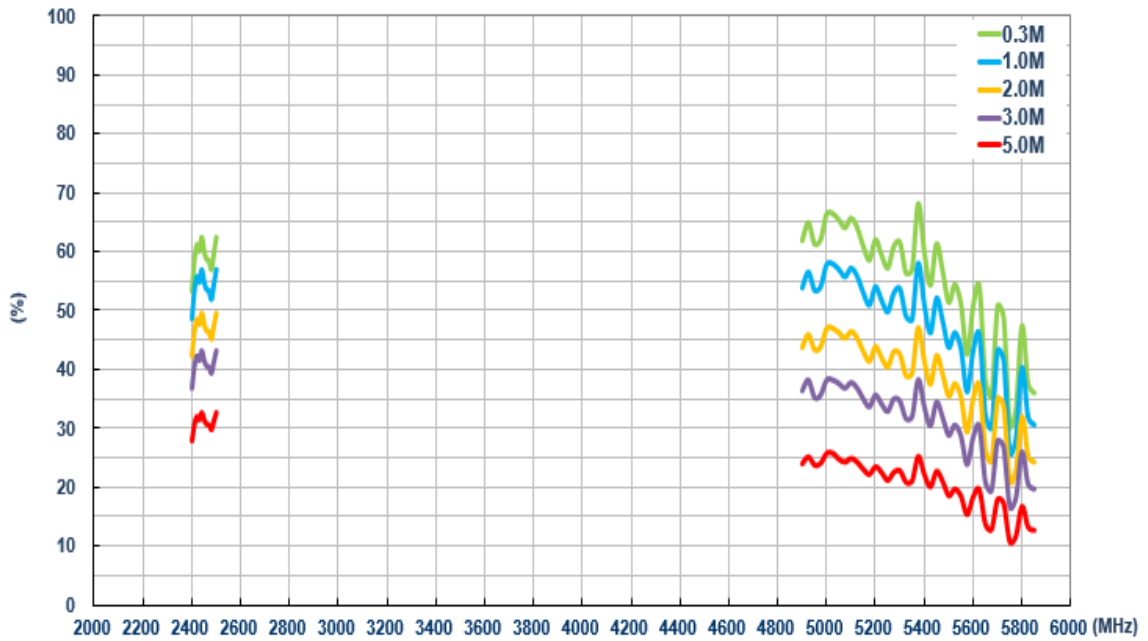

6.6.5 Efficiency (Wi-Fi_MIMO_2)

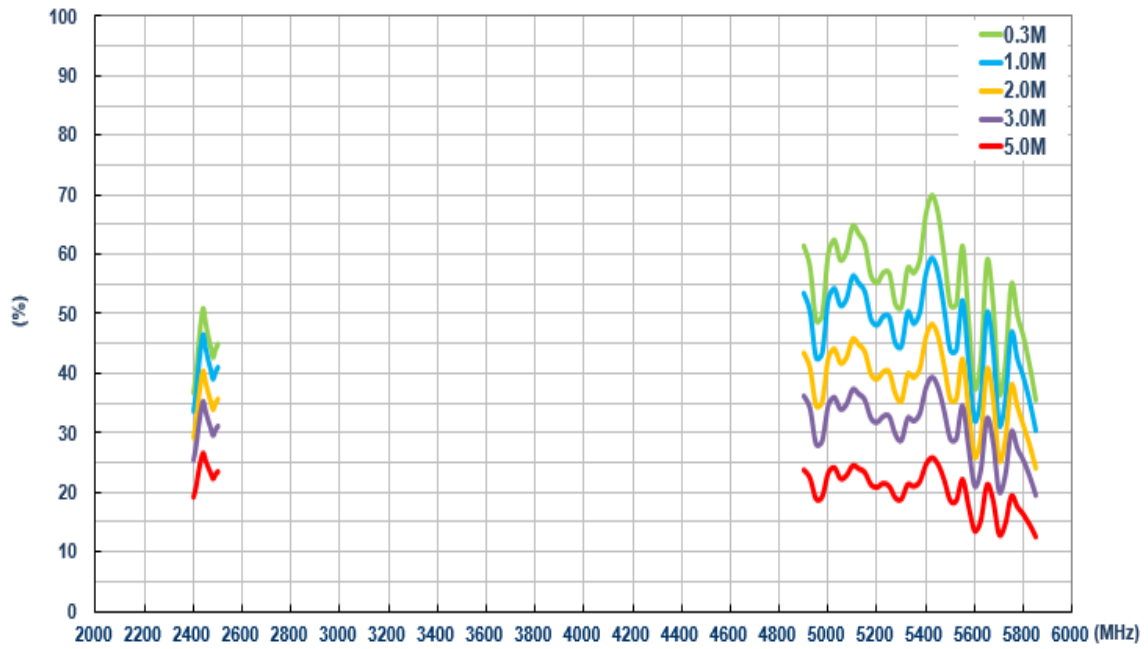

6.6.6 Average Gain (Wi-Fi_MIMO_1)

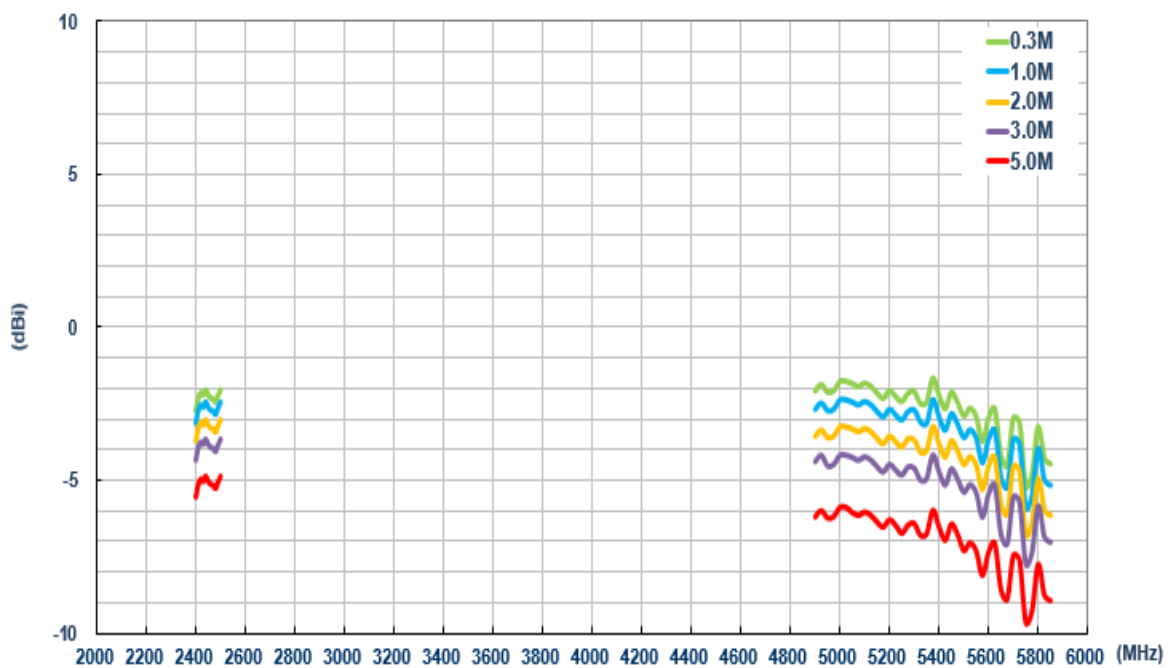

6.6.7 Average Gain (Wi-Fi _MIMO_2)

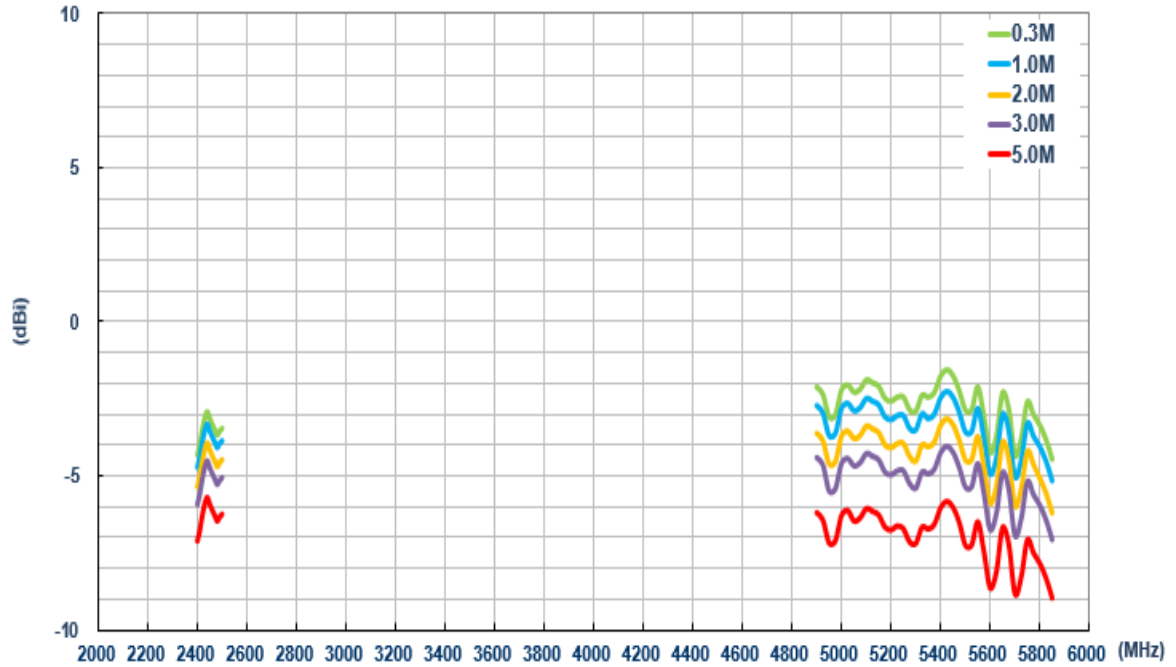

6.6.8 Peak Gain (Wi-Fi _MIMO_1)

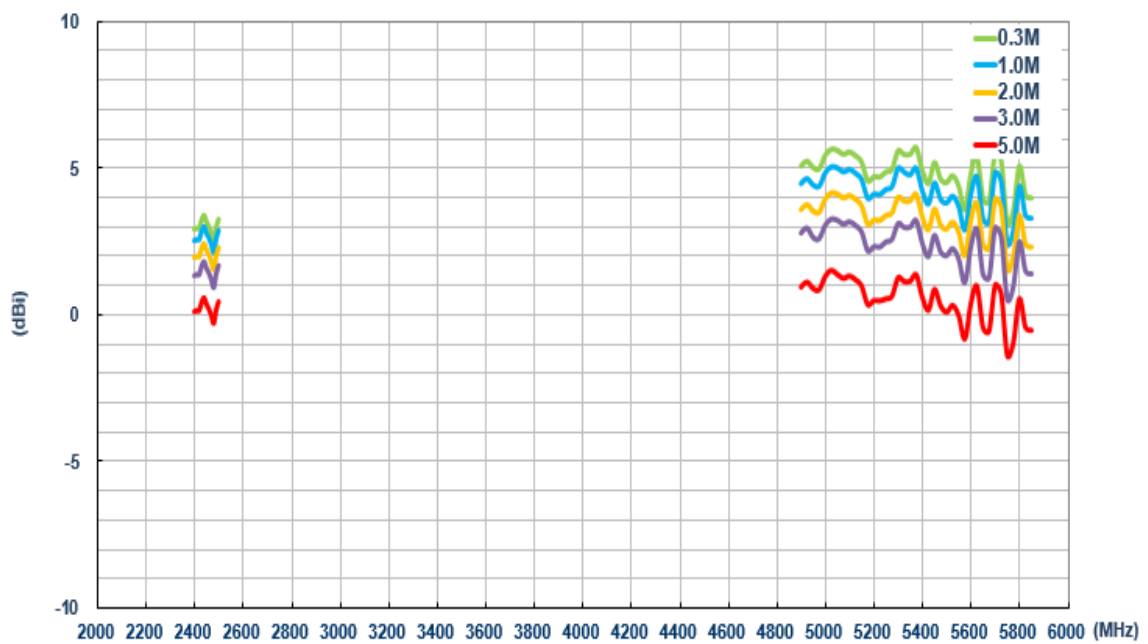

6.6.9 Peak Gain (Wi-Fi _MIMO_2)

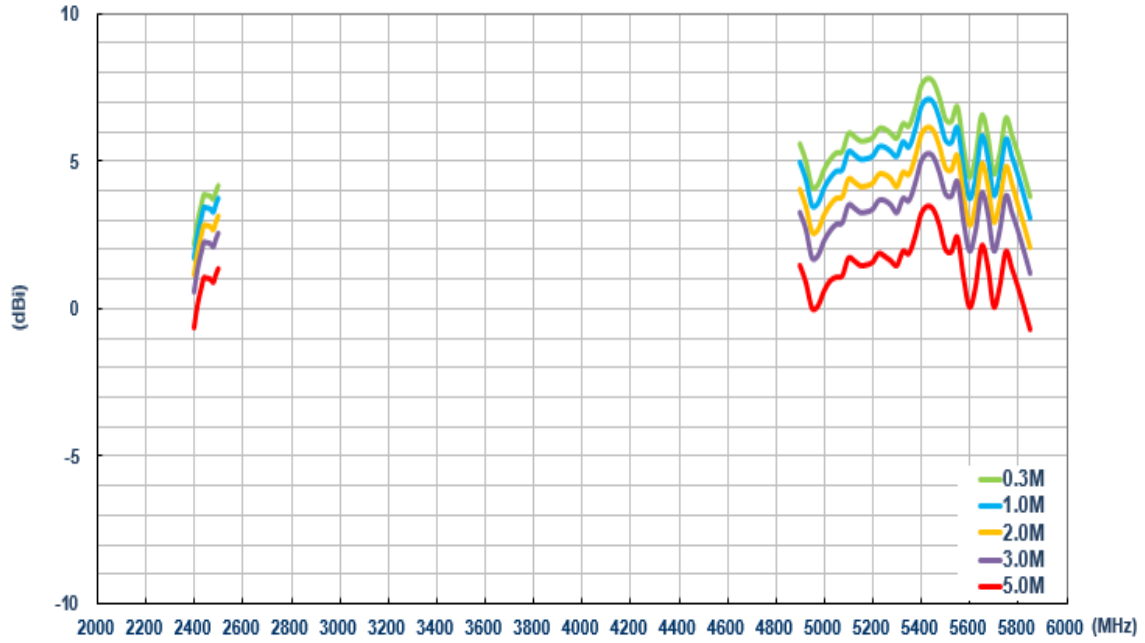

6.7 On metal (LTE)

6.7.1 Return Loss (LTE_MIMO_1)

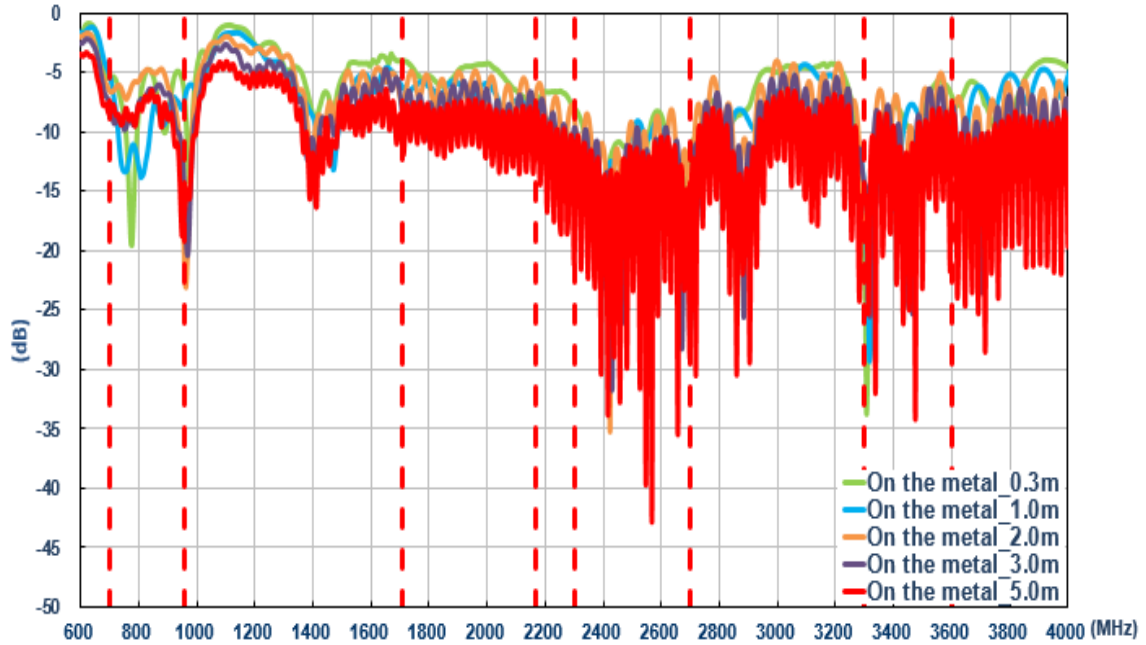

6.7.2 Return Loss (LTE_MIMO_2)

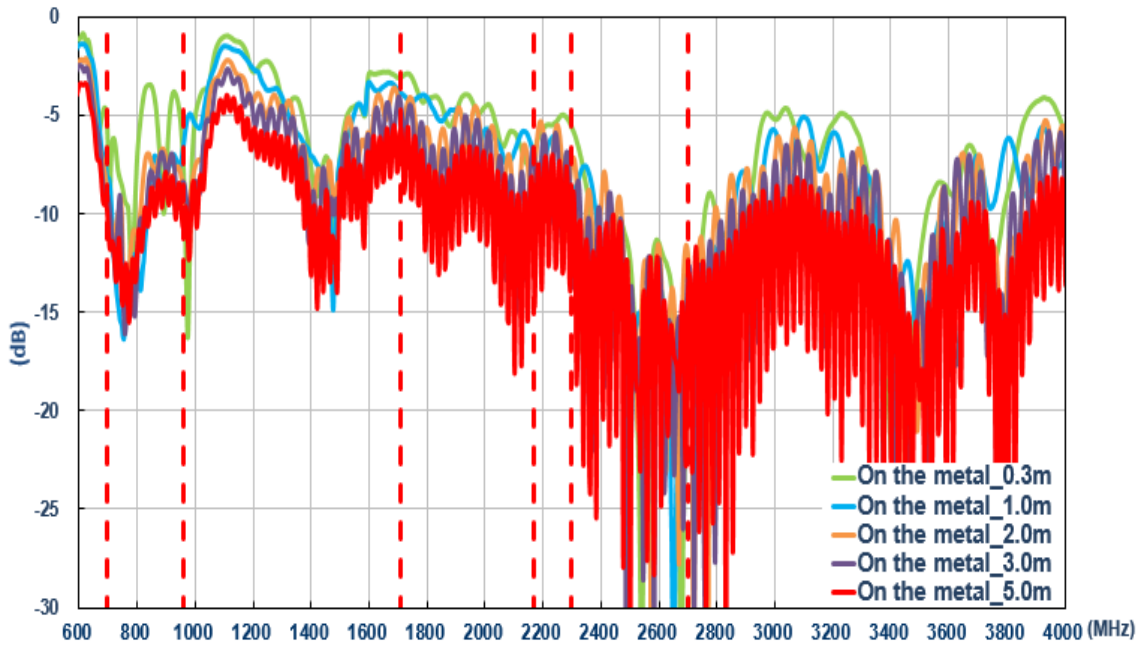

6.7.3 Isolation (LTE antenna)

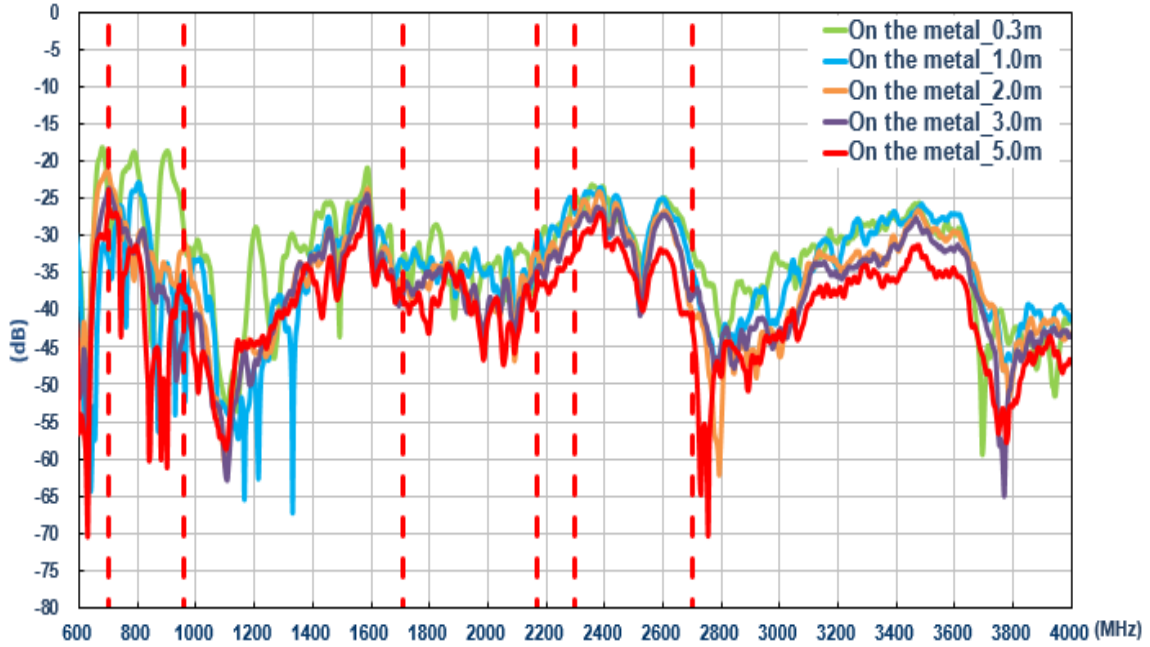

6.7.4 Efficiency (LTE_MIMO_1)

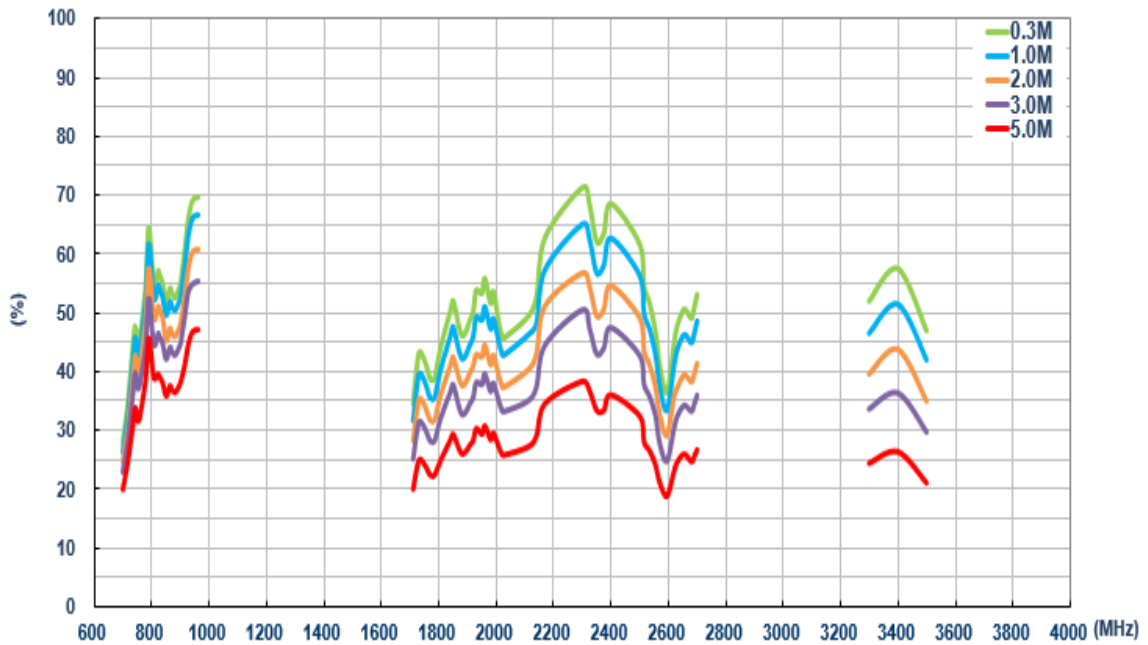

6.7.5 Efficiency (LTE_MIMO_2)

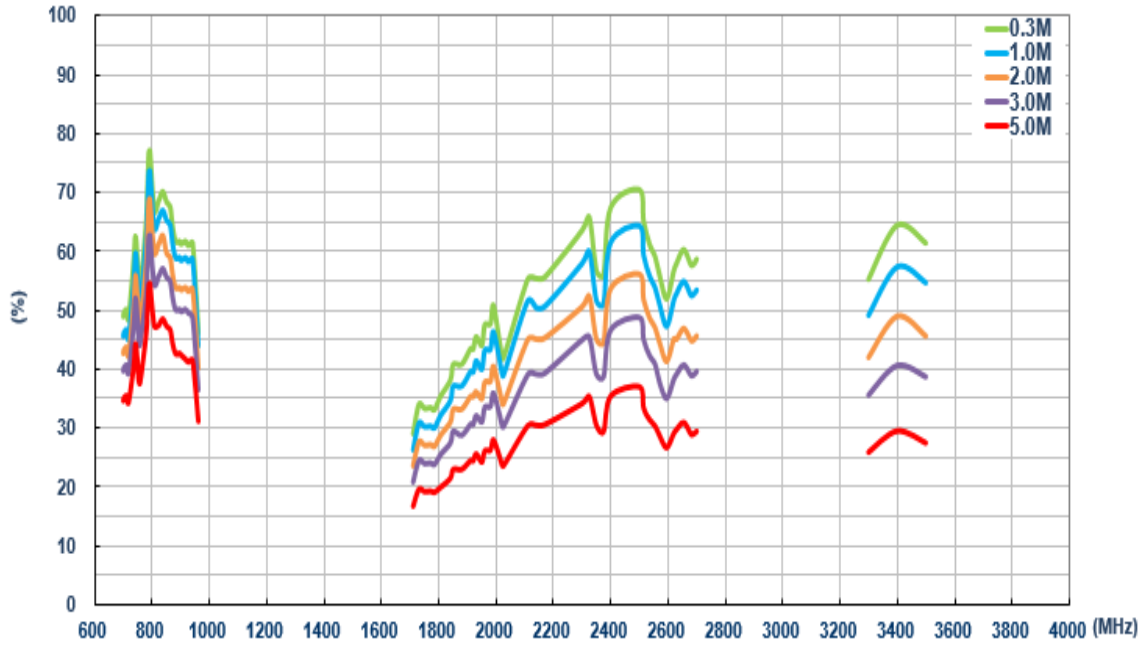

6.7.6 Average Gain (LTE_MIMO_1)

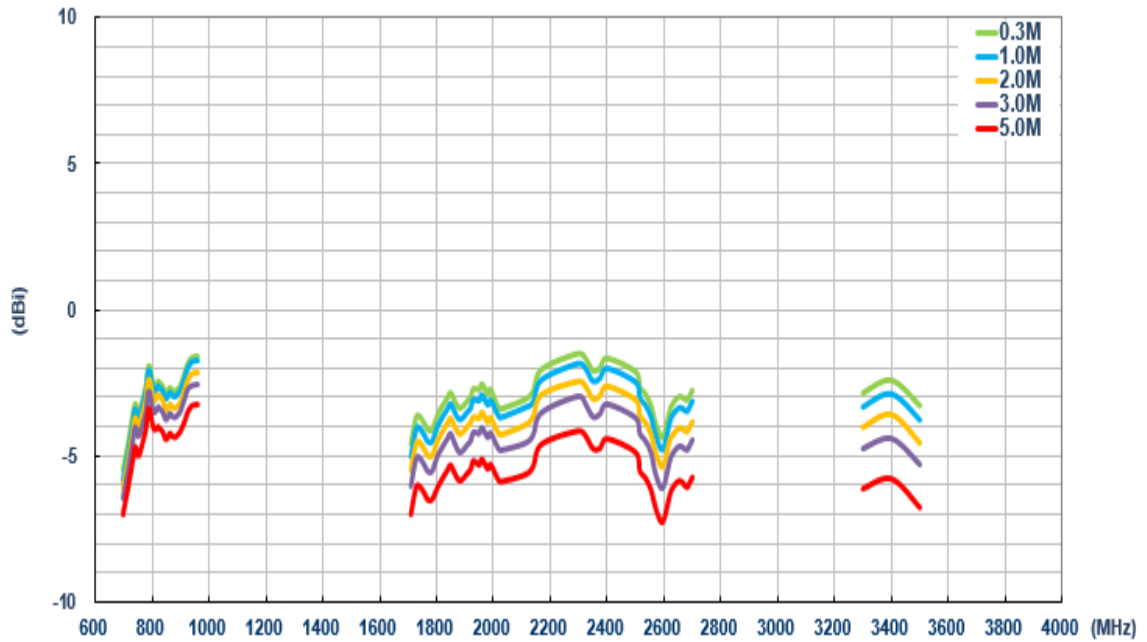

6.7.7 Average Gain (LTE_MIMO_2)

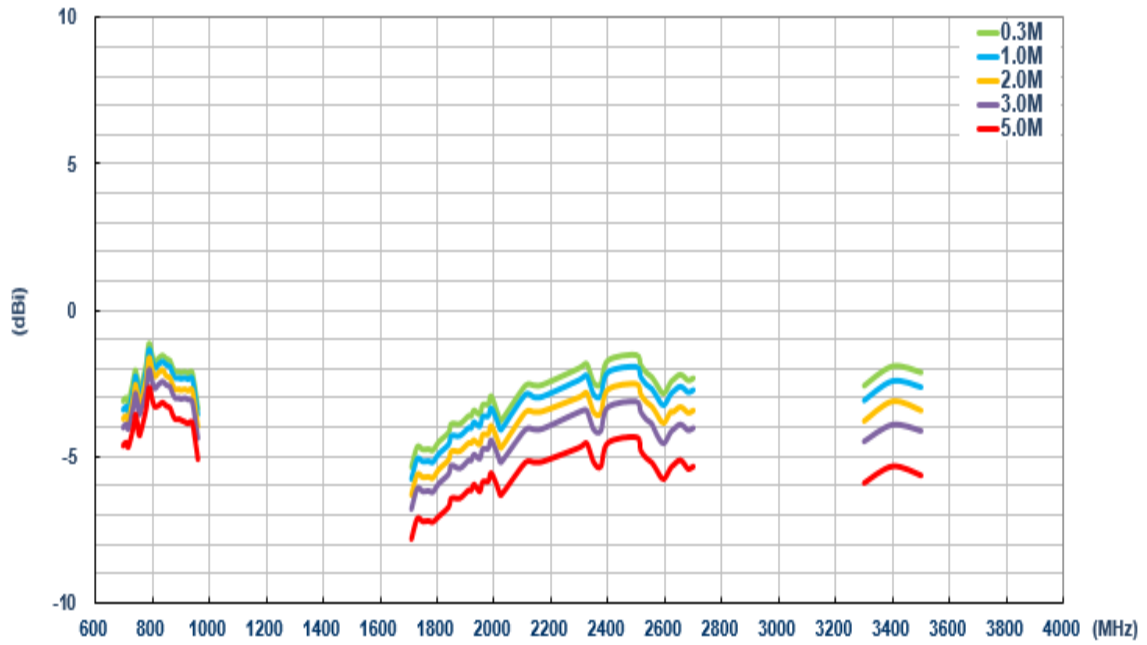

6.7.8 Peak Gain (LTE_MIMO_1)

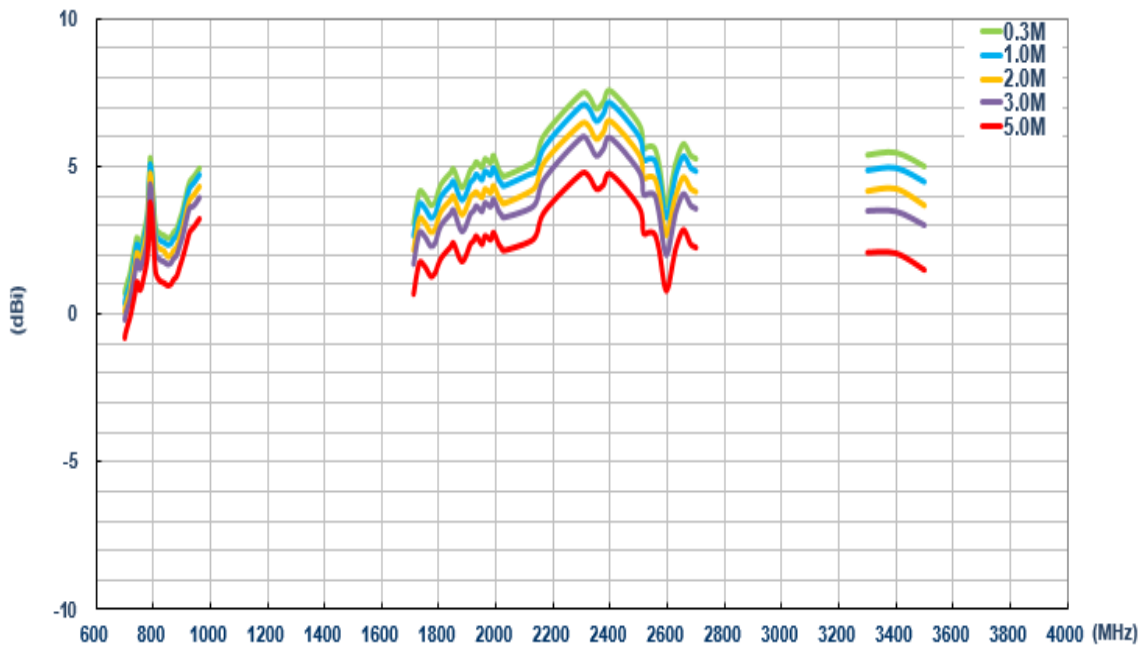

6.7.9 Peak Gain (LTE_MIMO_2)

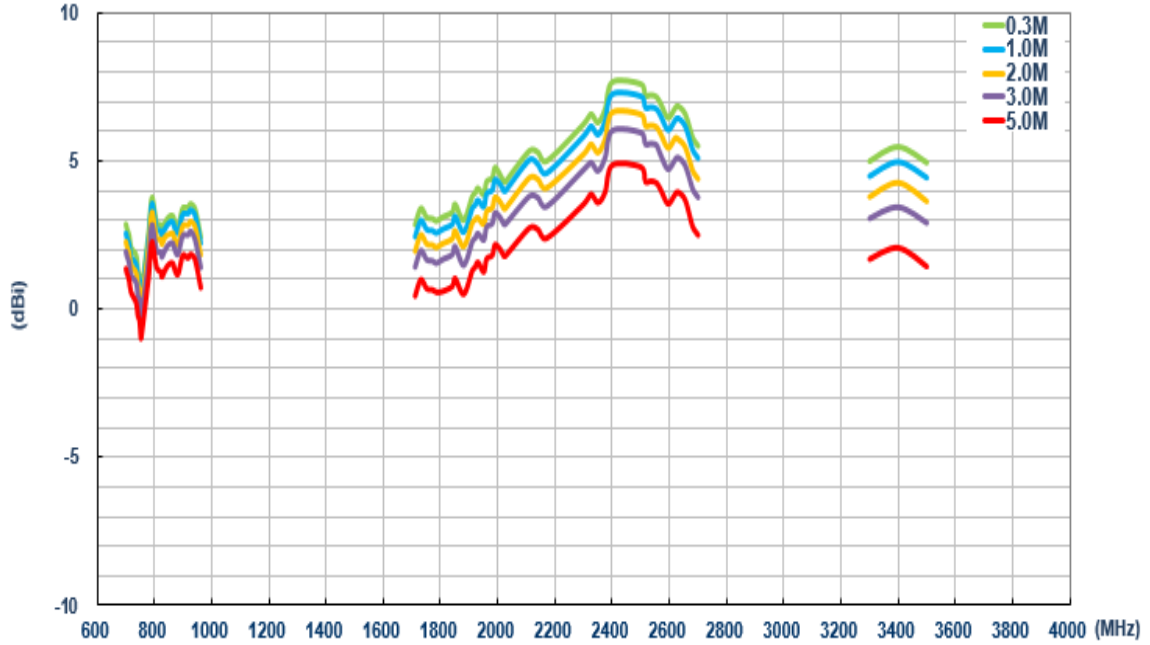

6.8 On metal (Wi-Fi)

6.8.1 Return Loss (Wi-Fi _MIMO_1)

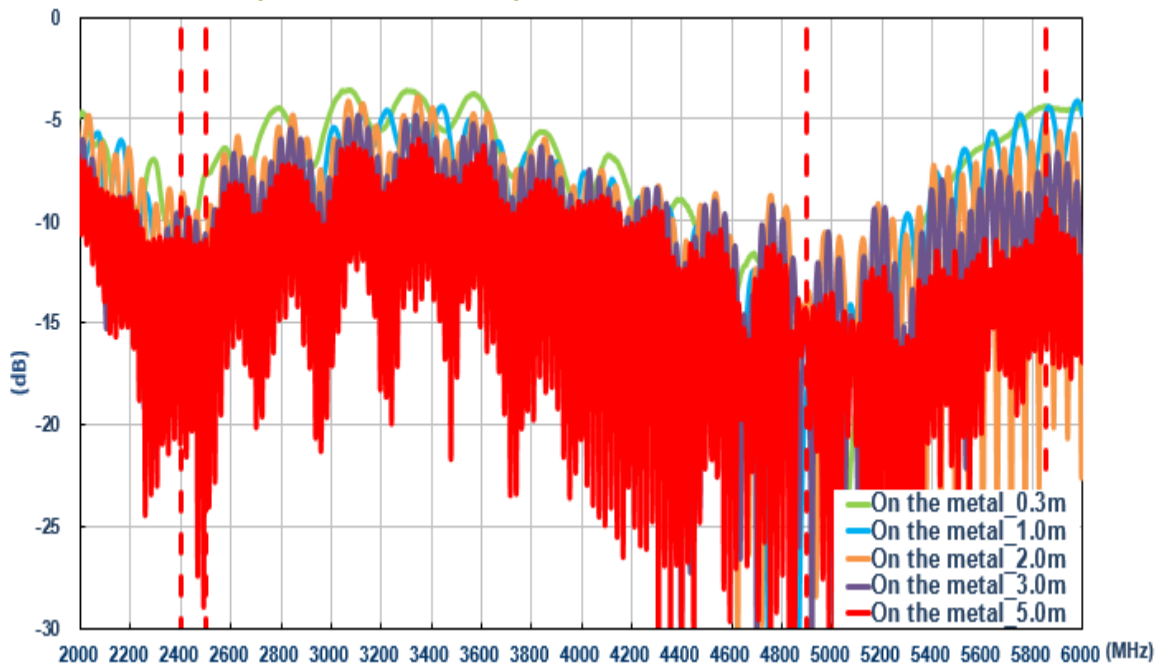

6.8.2 Return Loss (Wi-Fi_MIMO_2)

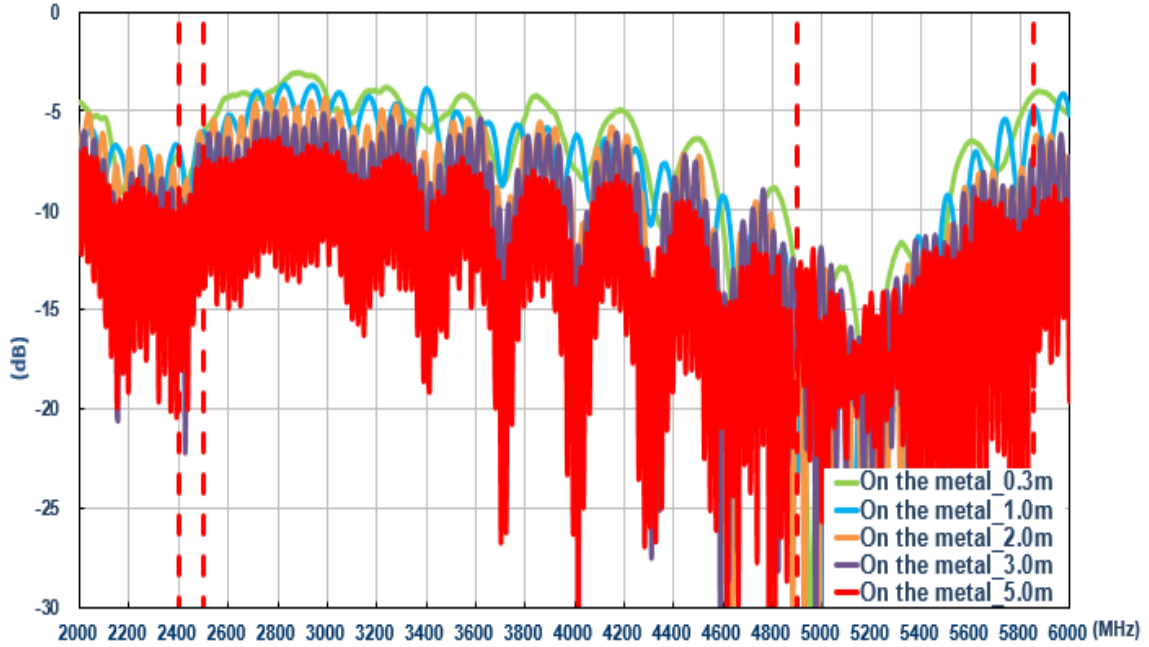

6.8.3 Isolation (Wi-Fi)

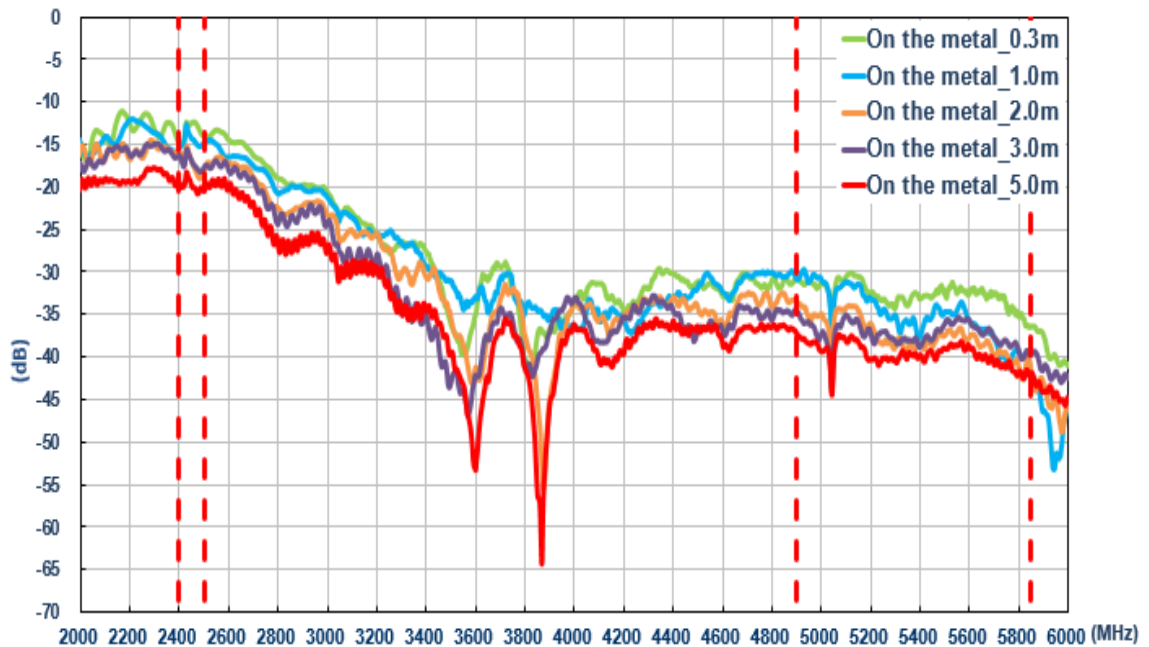

6.8.4 Efficiency (Wi-Fi_MIMO_1)

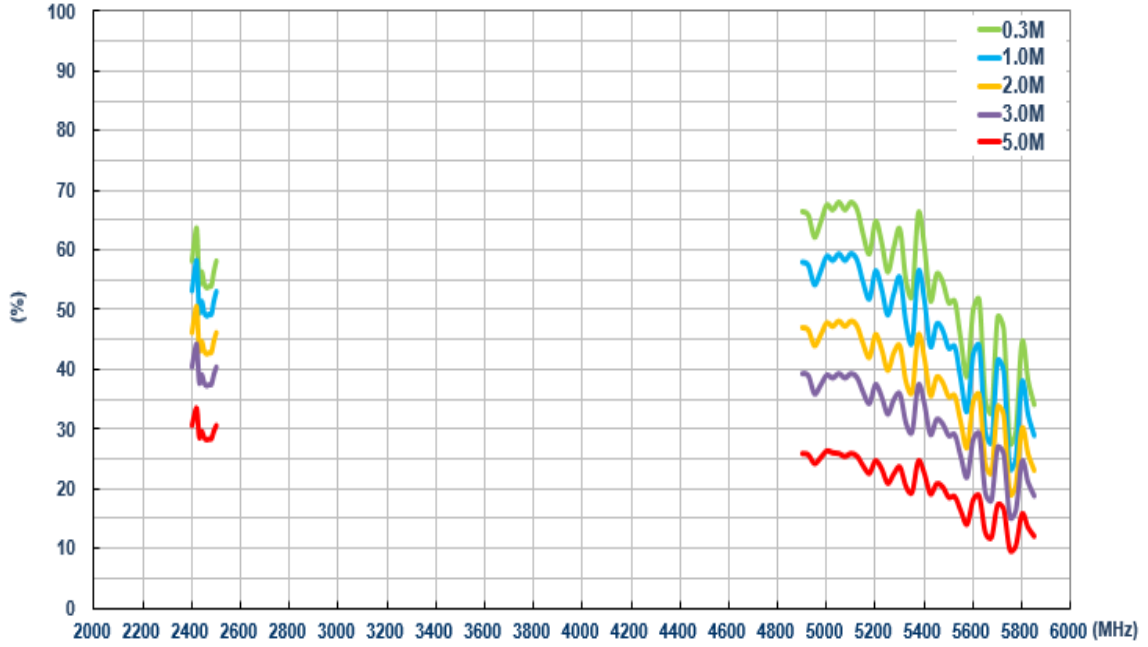

6.8.5 Efficiency (Wi-Fi_MIMO_2)

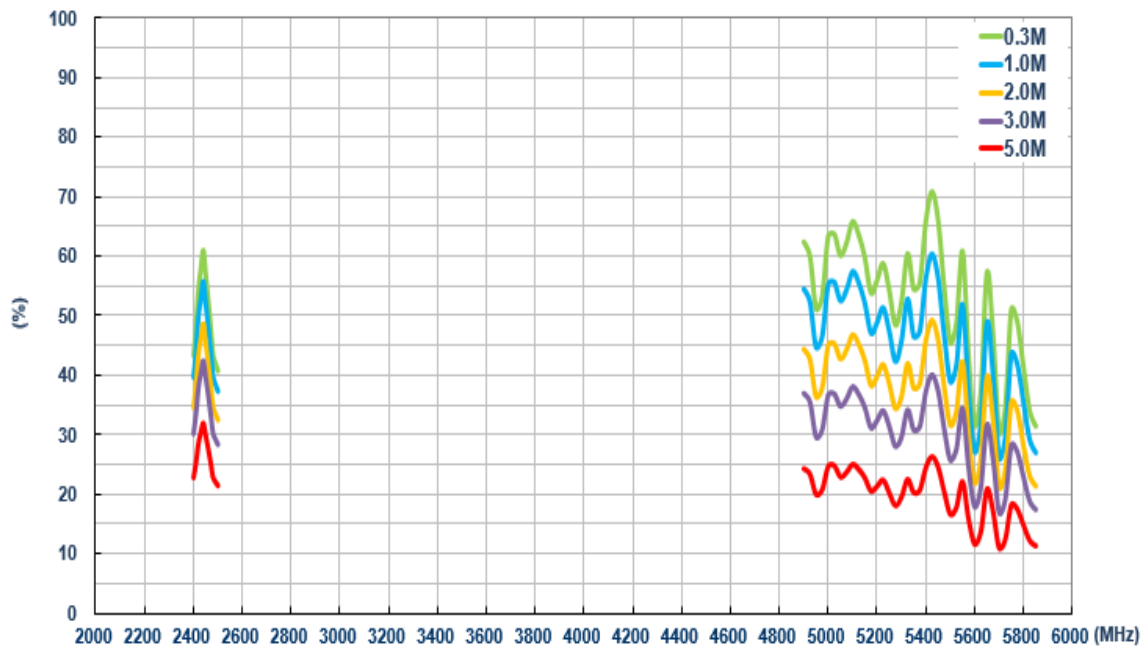

6.8.6 Average Gain (Wi-Fi_MIMO_1)

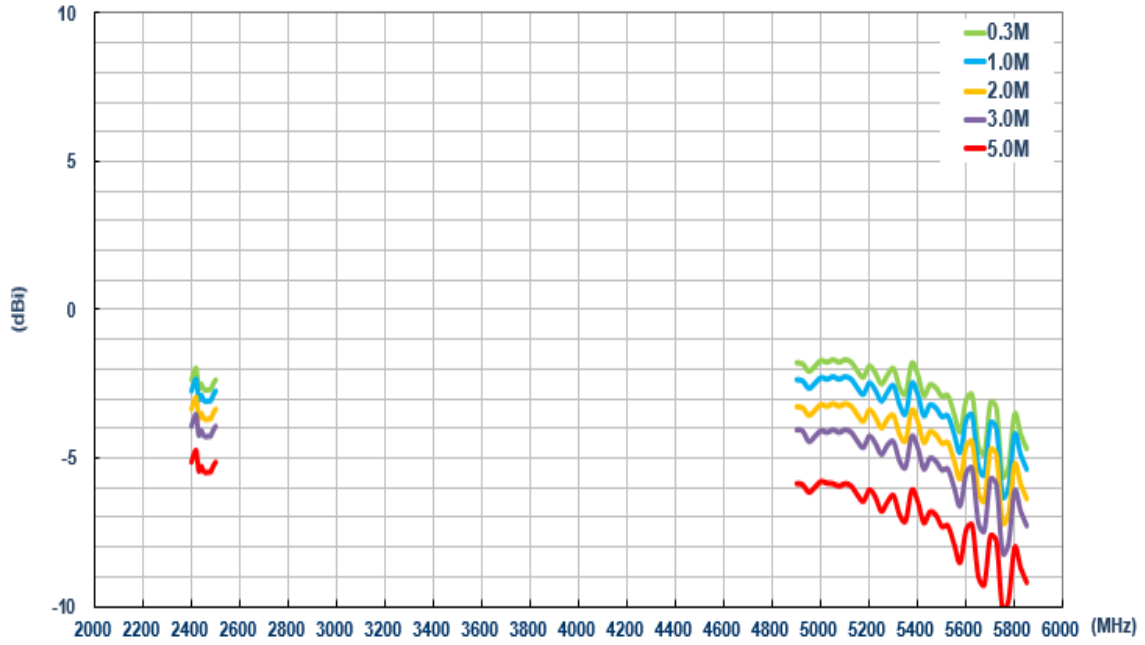

6.8.7 Average Gain (Wi-Fi_MIMO_2)

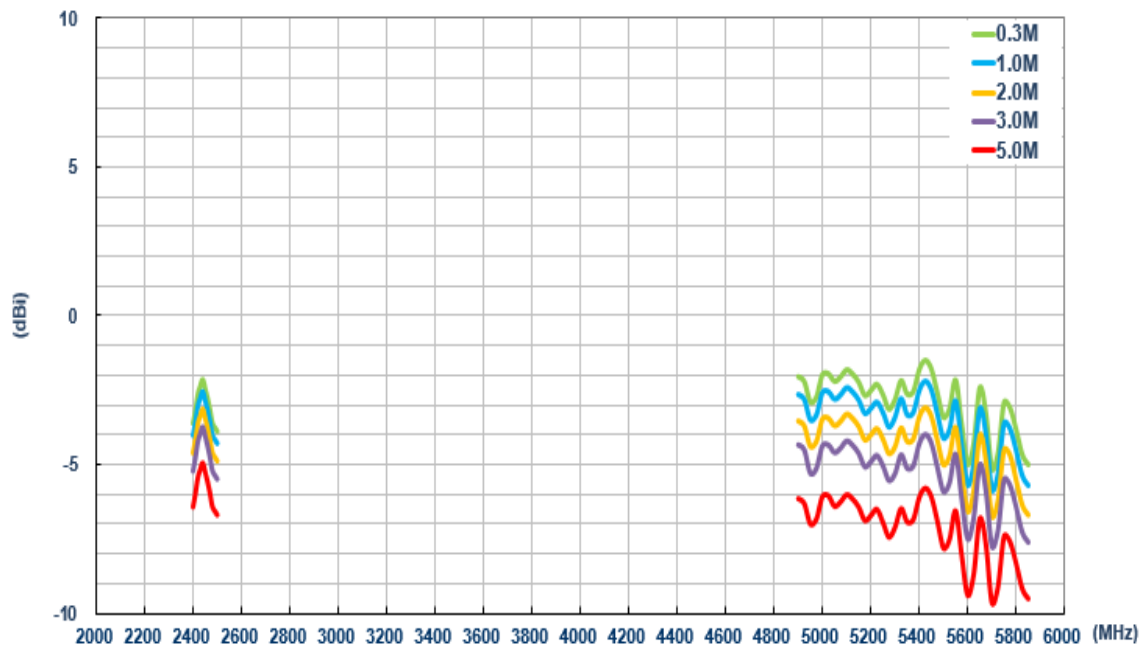

6.8.8 Peak Gain (Wi-Fi_MIMO_1)

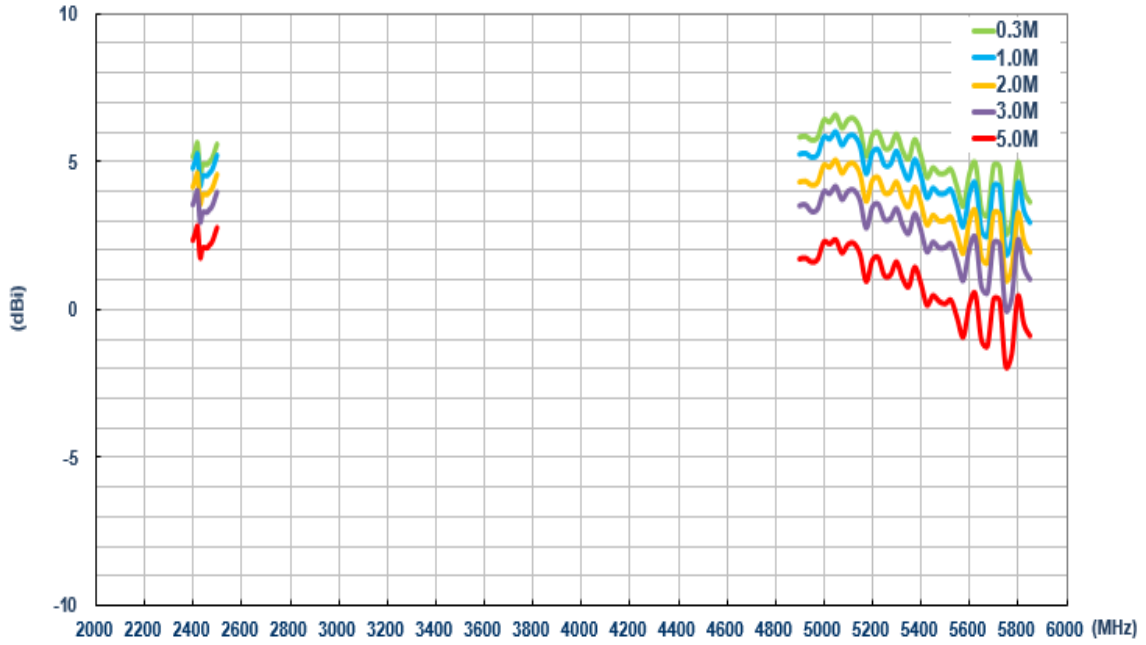

6.8.9 Peak Gain (Wi-Fi_MIMO_2)

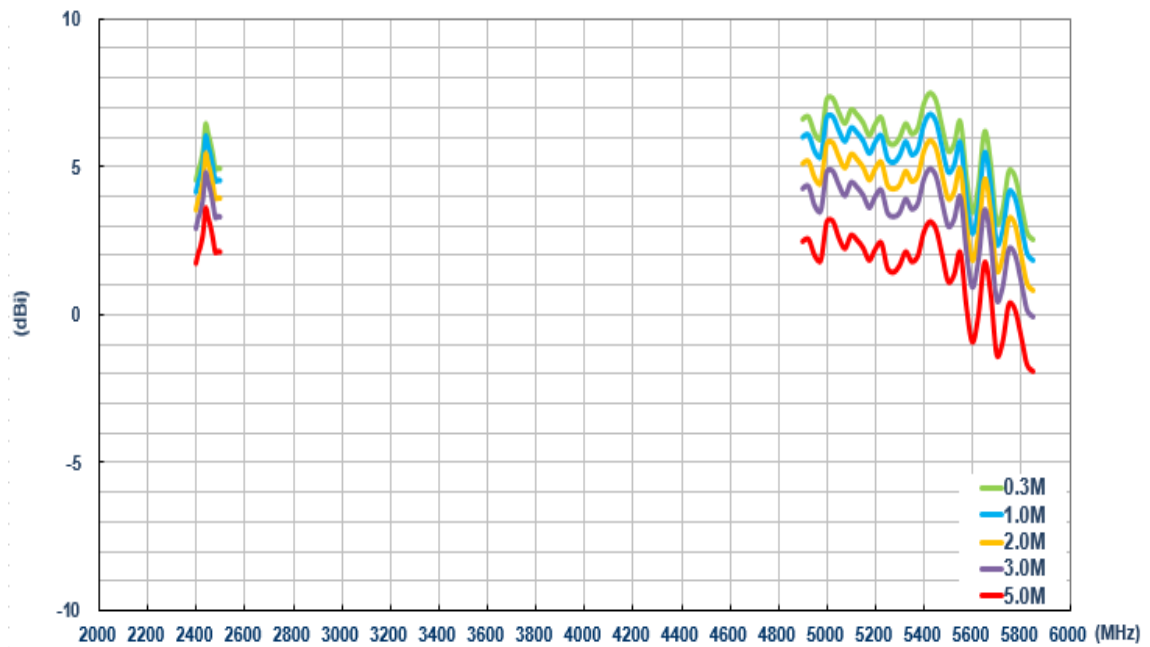

6.9 On the wall (LTE)

6.9.1 Return Loss (LTE_MIMO_1)

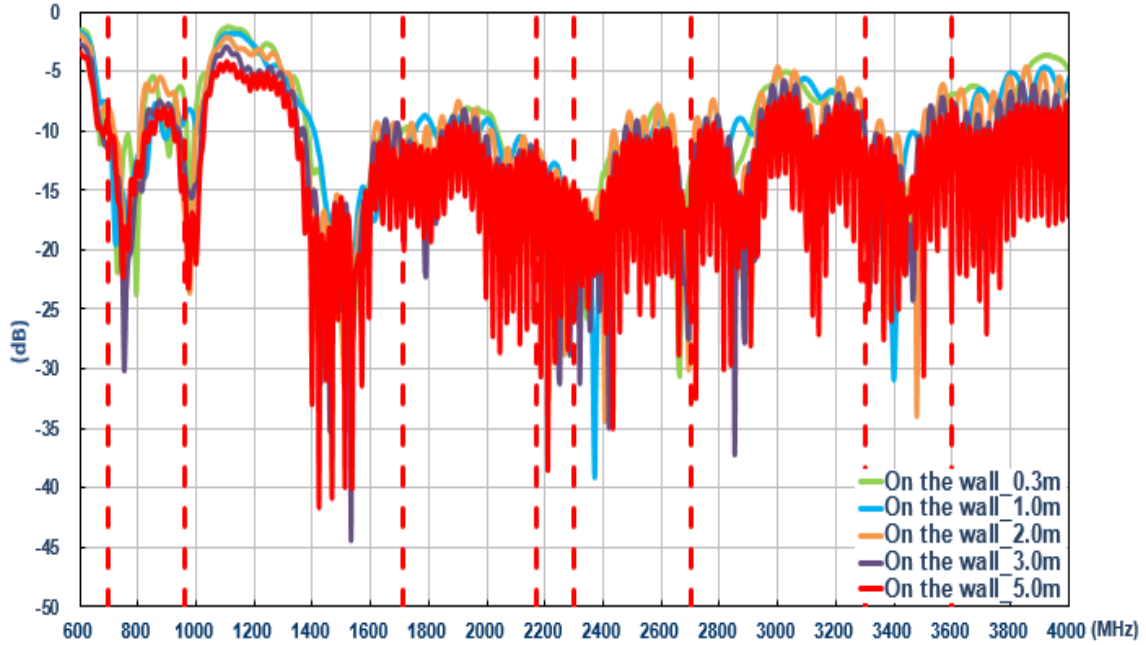

6.9.2 Return Loss (LTE_MIMO_2)

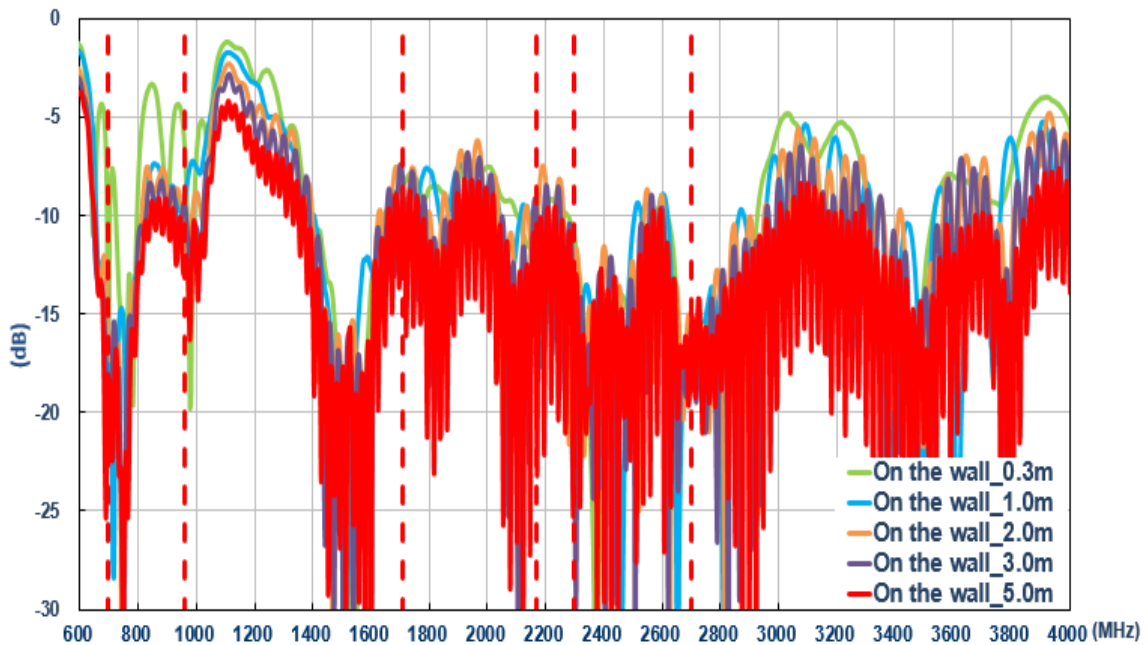

6.9.3 Isolation (LTE antenna)

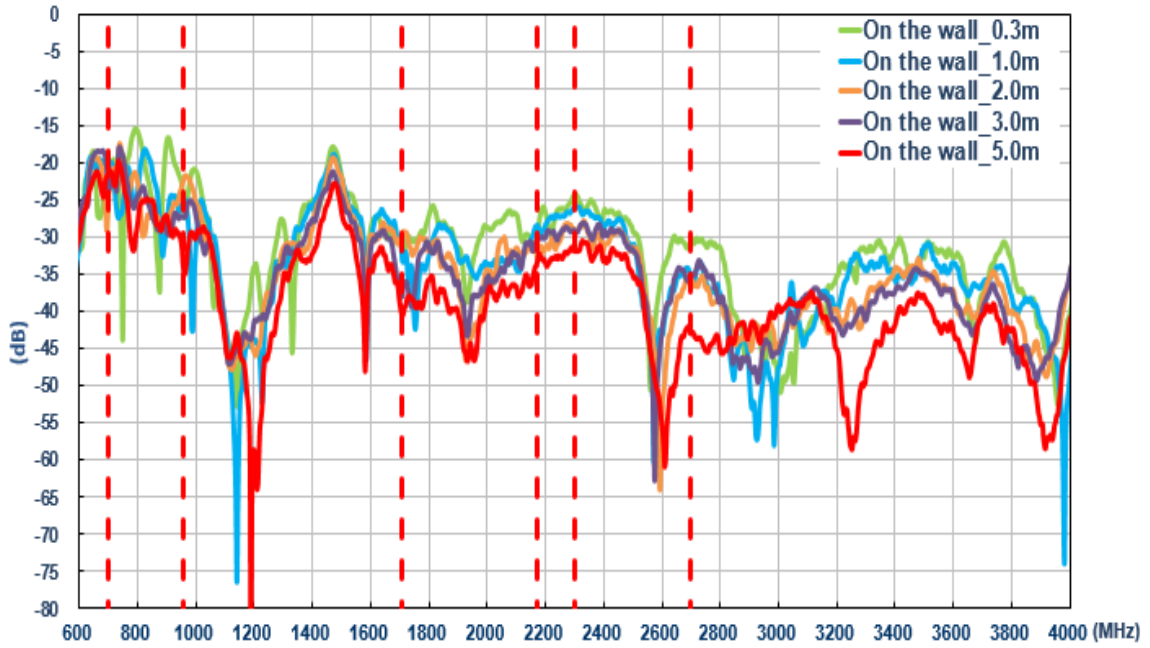

6.9.4 Efficiency (LTE_MIMO_1)

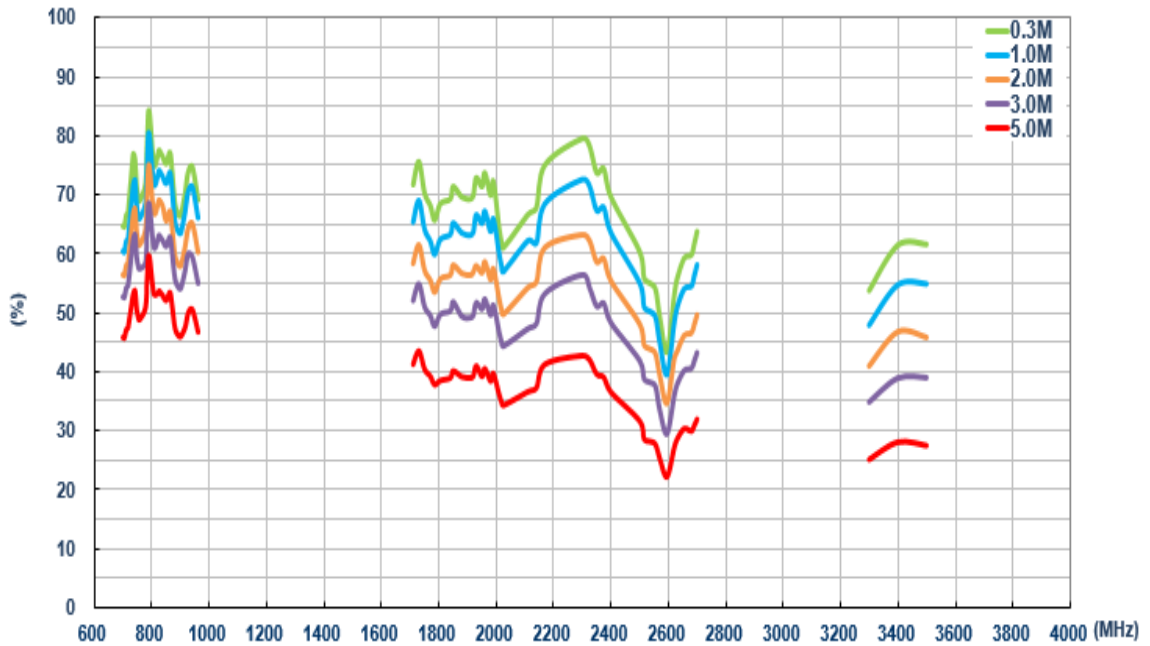

6.9.5 Efficiency (LTE_MIMO_2)

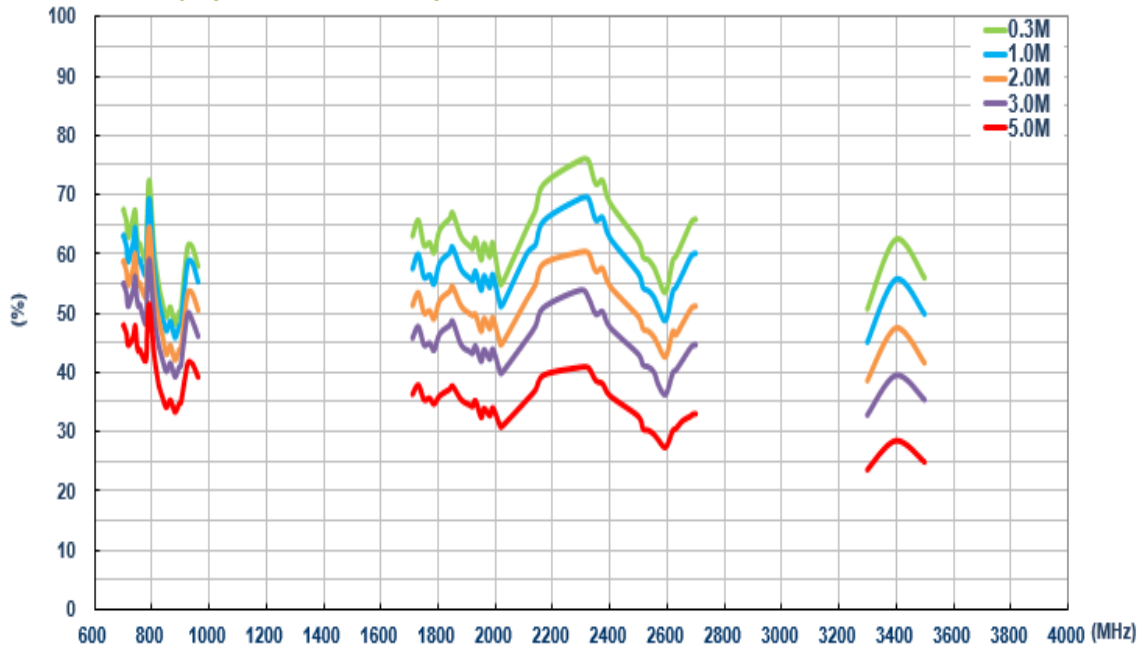

6.9.6 Average Gain (LTE_MIMO_1)

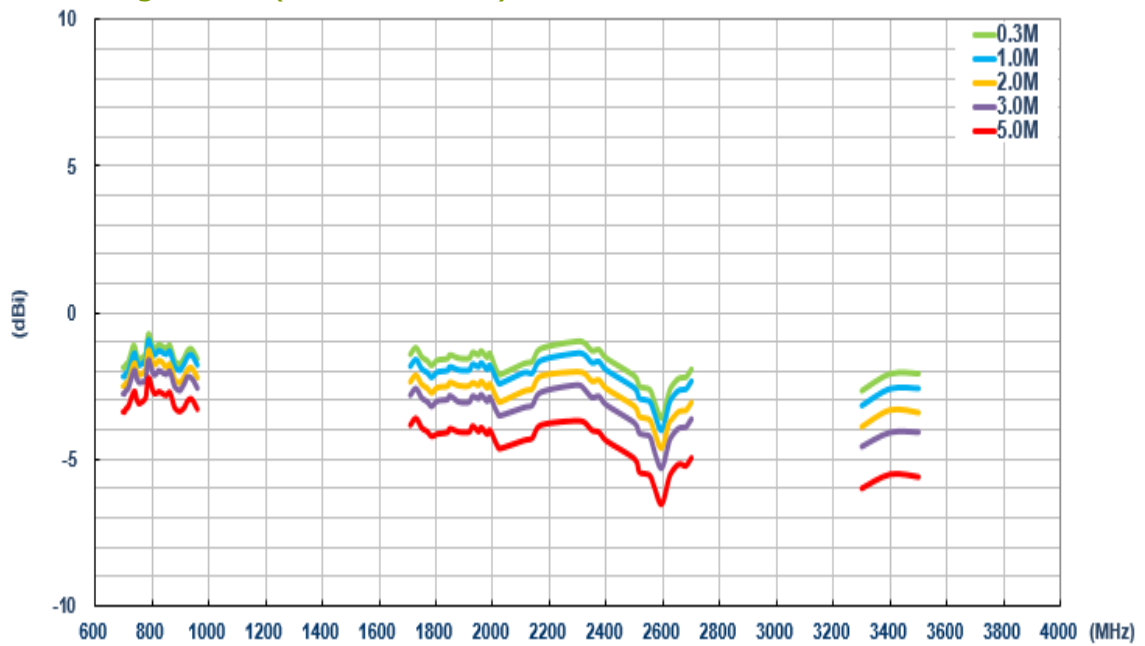

6.9.7 Average Gain (LTE_MIMO_2)

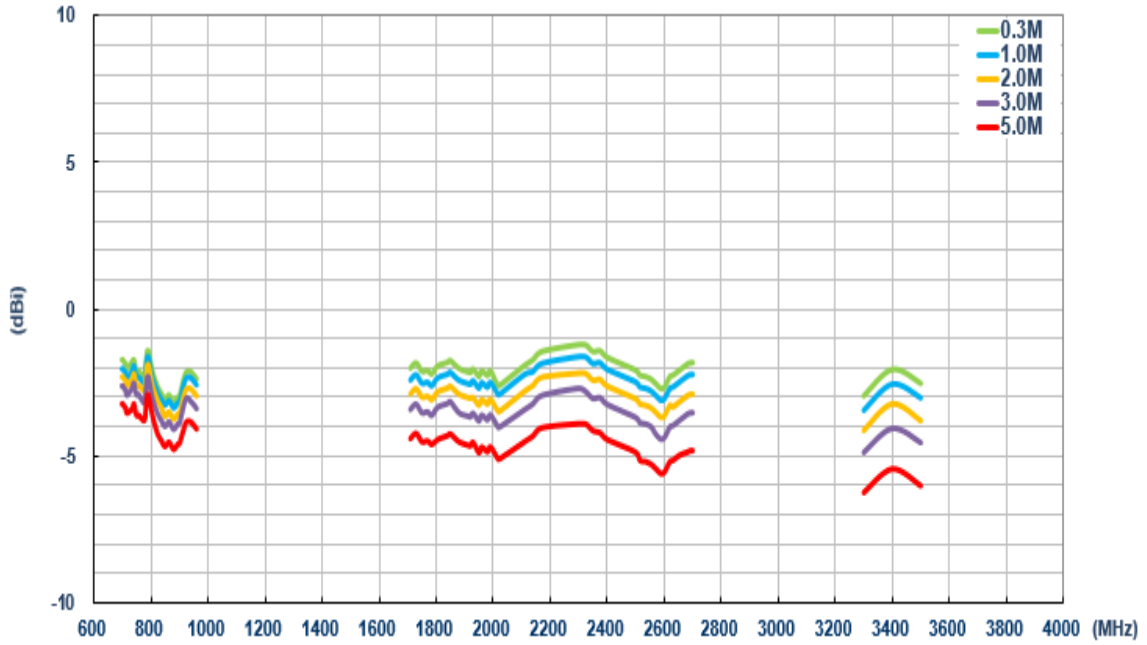

6.9.8 Peak Gain (LTE_MIMO_1)

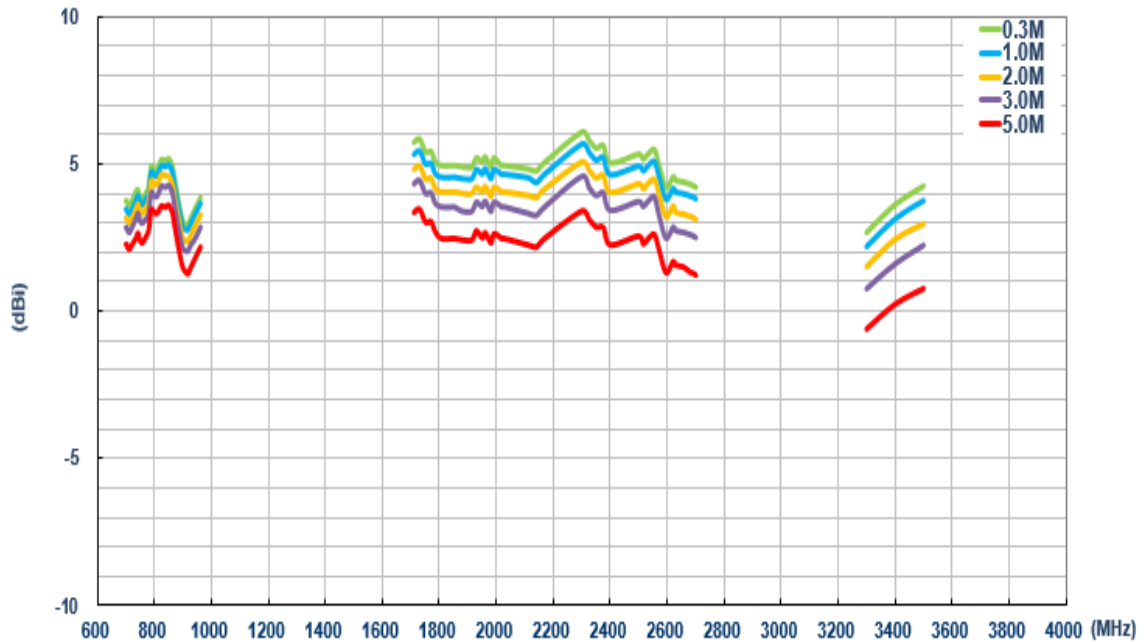

6.1.9 Peak Gain (LTE_MIMO_2)

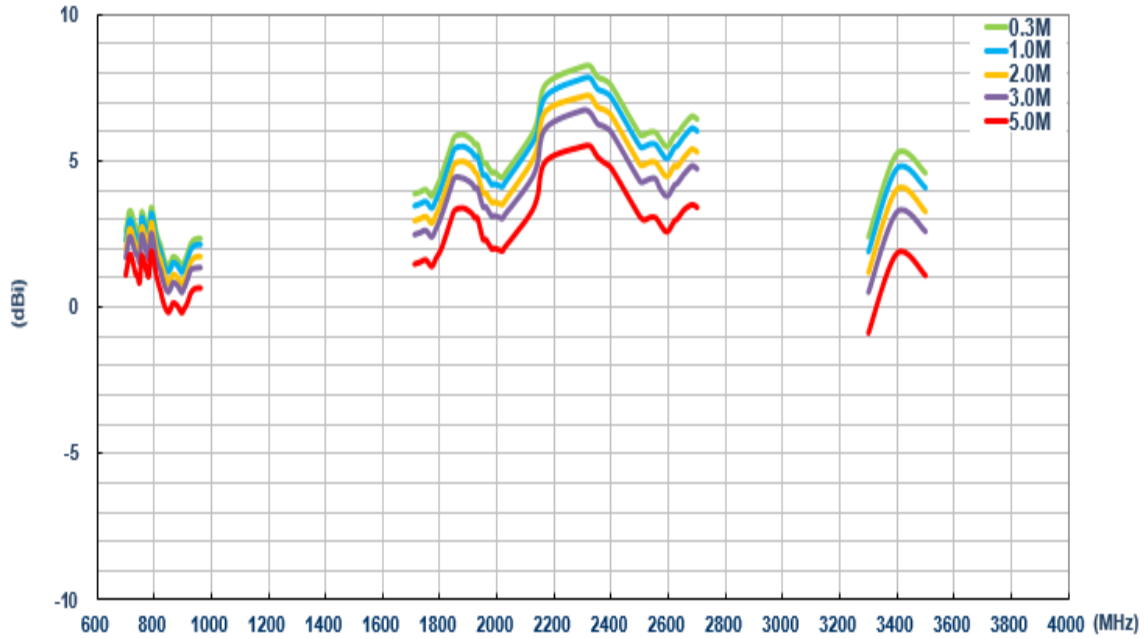

6.10 On the wall (Wi-Fi)

6.10.1 Return Loss (Wi-Fi_MIMO_1)

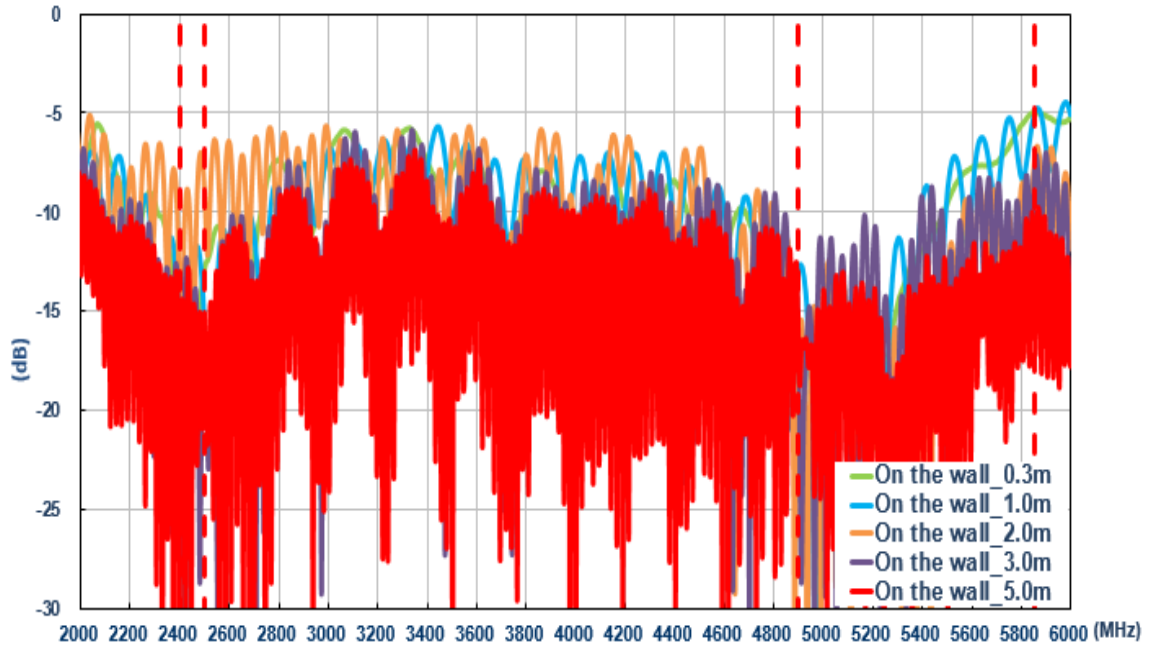

6.10.2 Return Loss (Wi-Fi_MIMO_2)

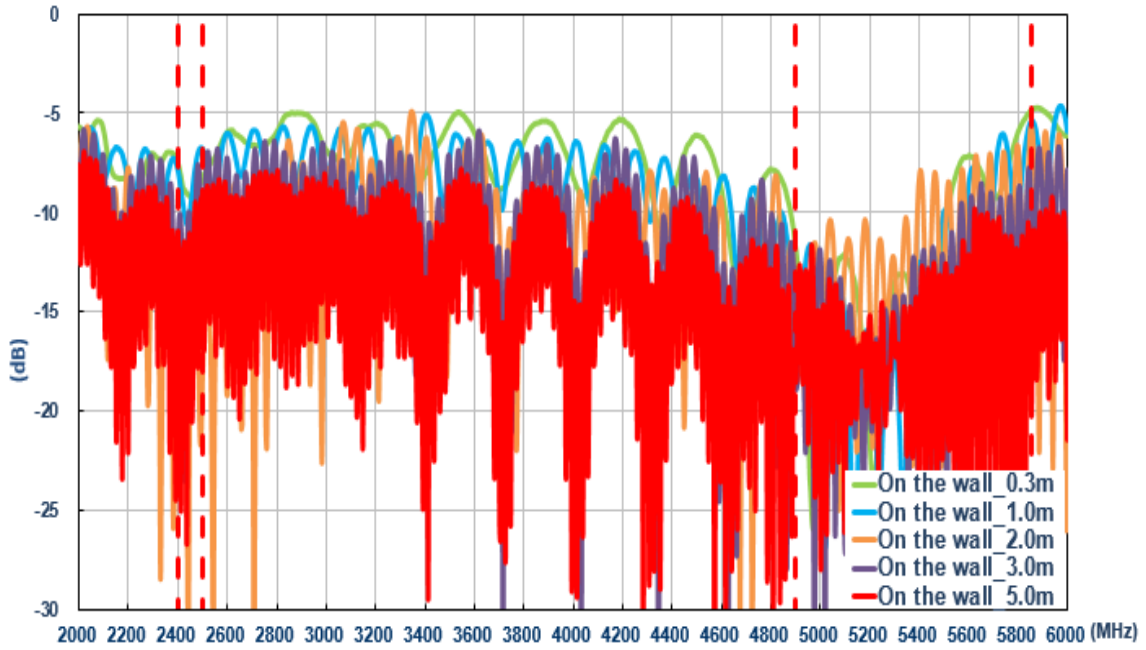

6.10.3 Isolation (Wi-Fi)

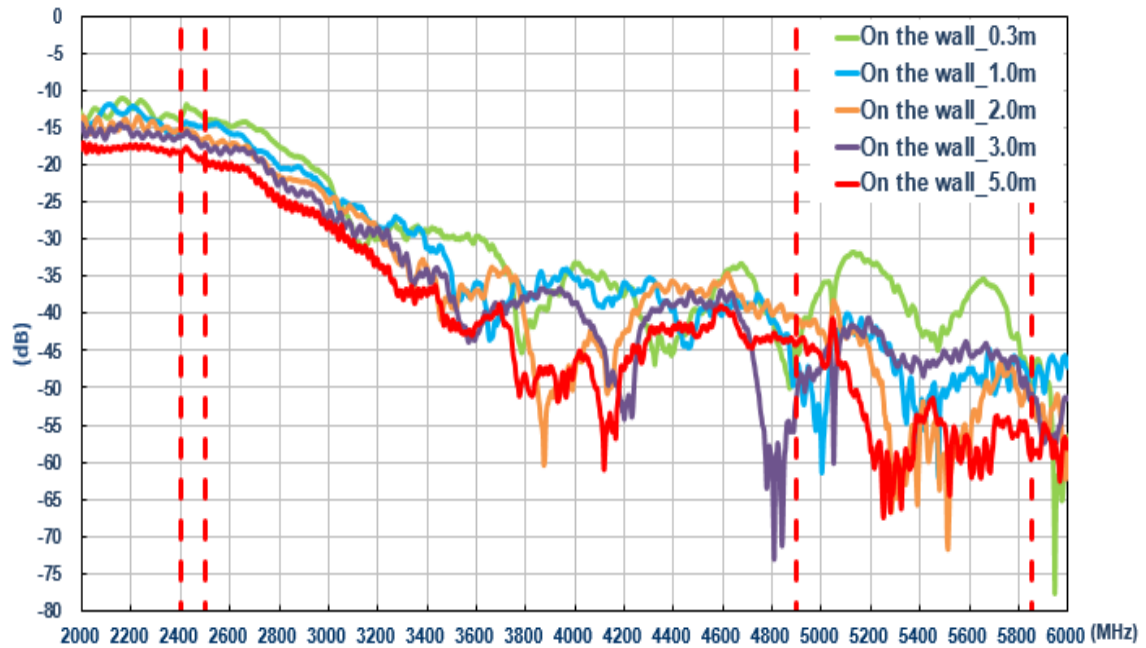

6.10.4 Efficiency (Wi-Fi_MIMO_1)

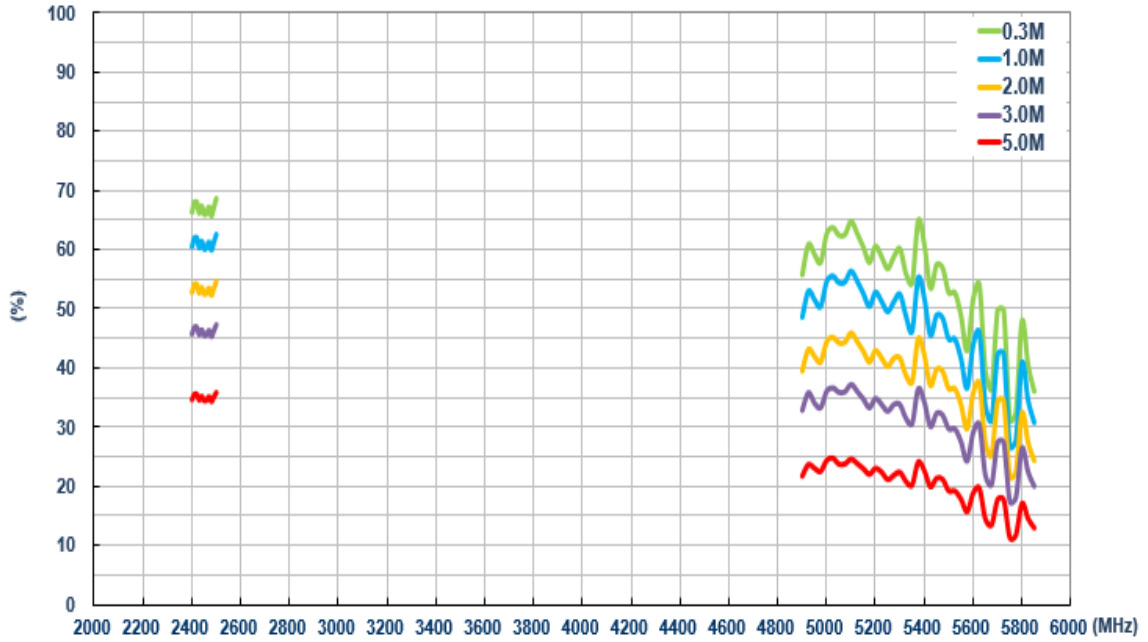

6.10.5 Efficiency (Wi-Fi_MIMO_2)

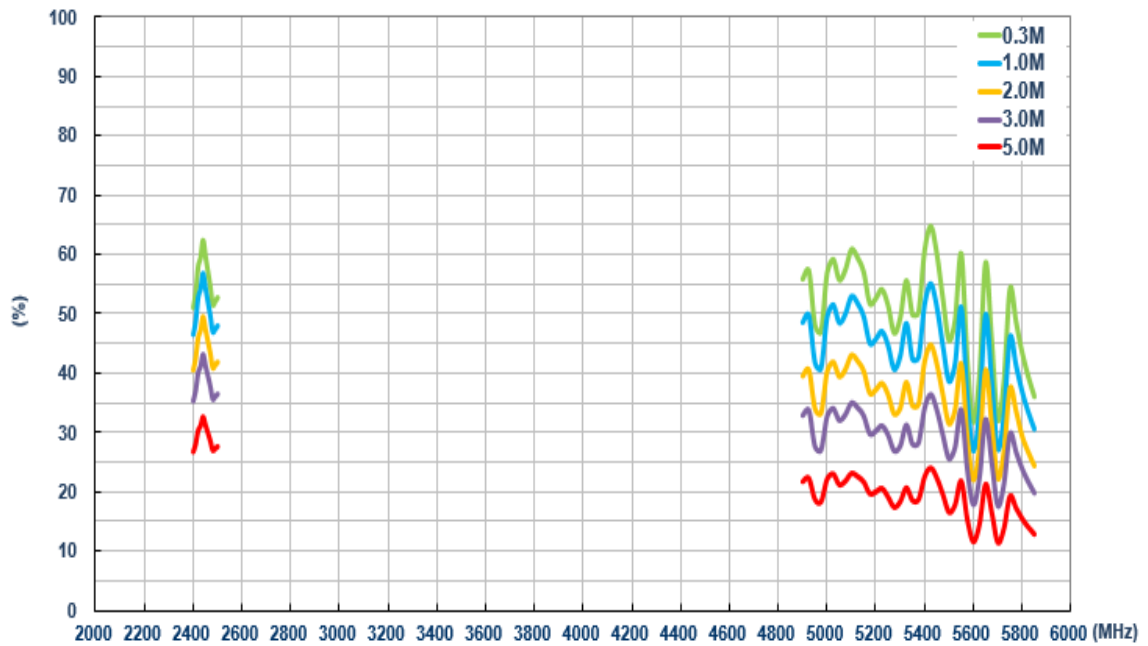

6.10.6 Average Gain (Wi-Fi_MIMO_1)

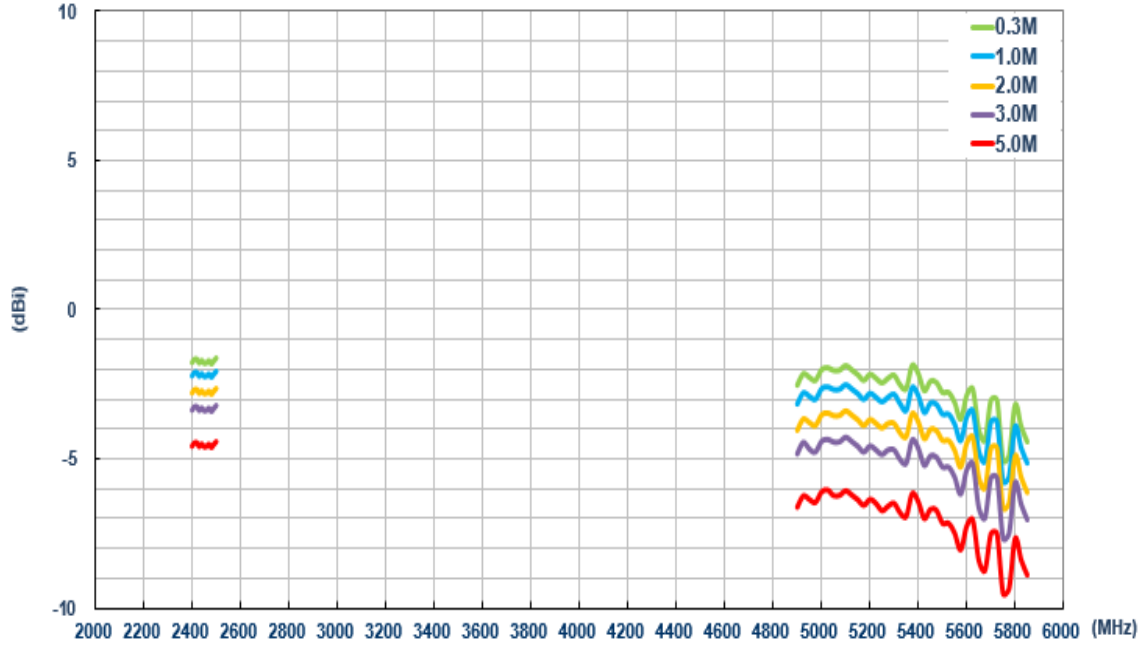

6.10.7 Average Gain (Wi-Fi_MIMO_2)

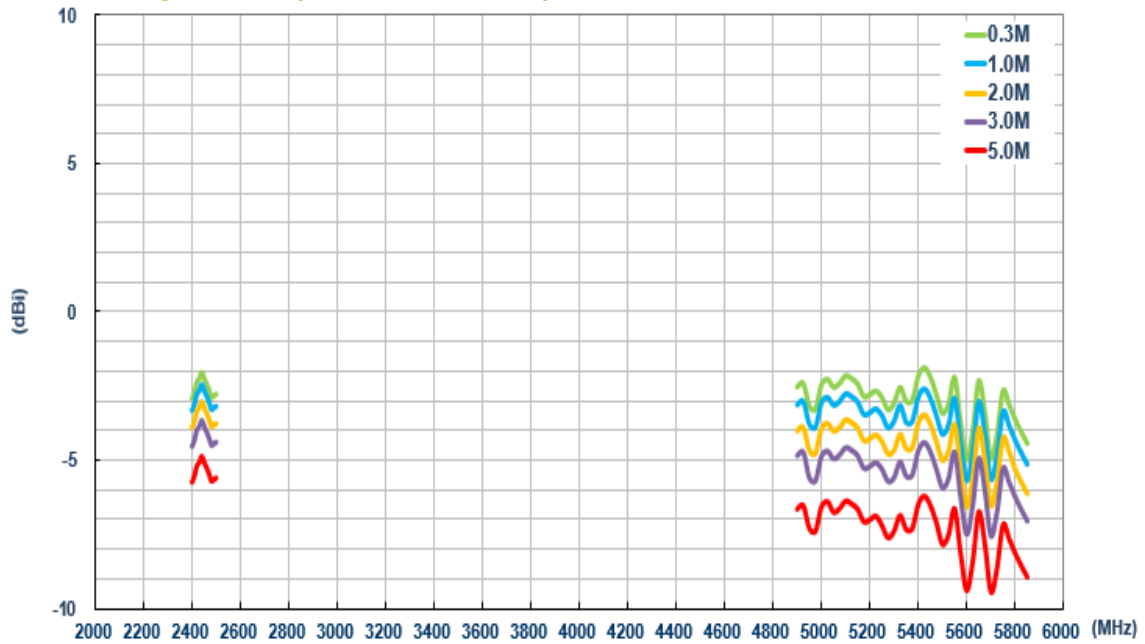

6.10.8 Peak Gain (Wi-Fi_MIMO_1)

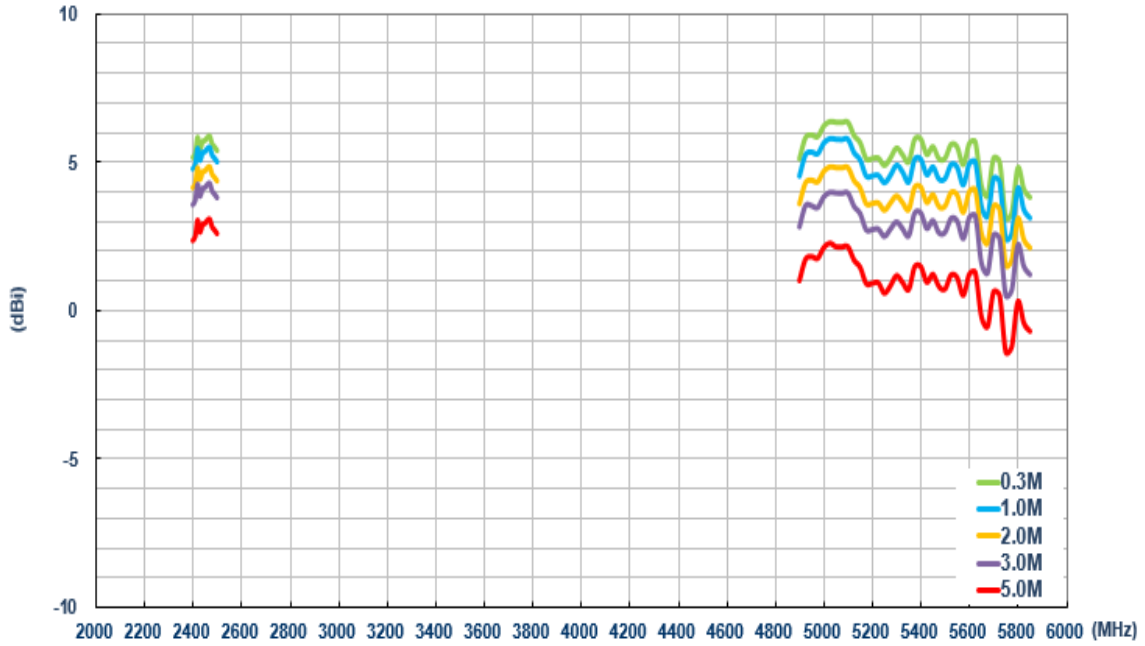

6.10.9 Peak Gain (Wi-Fi_MIMO_2)

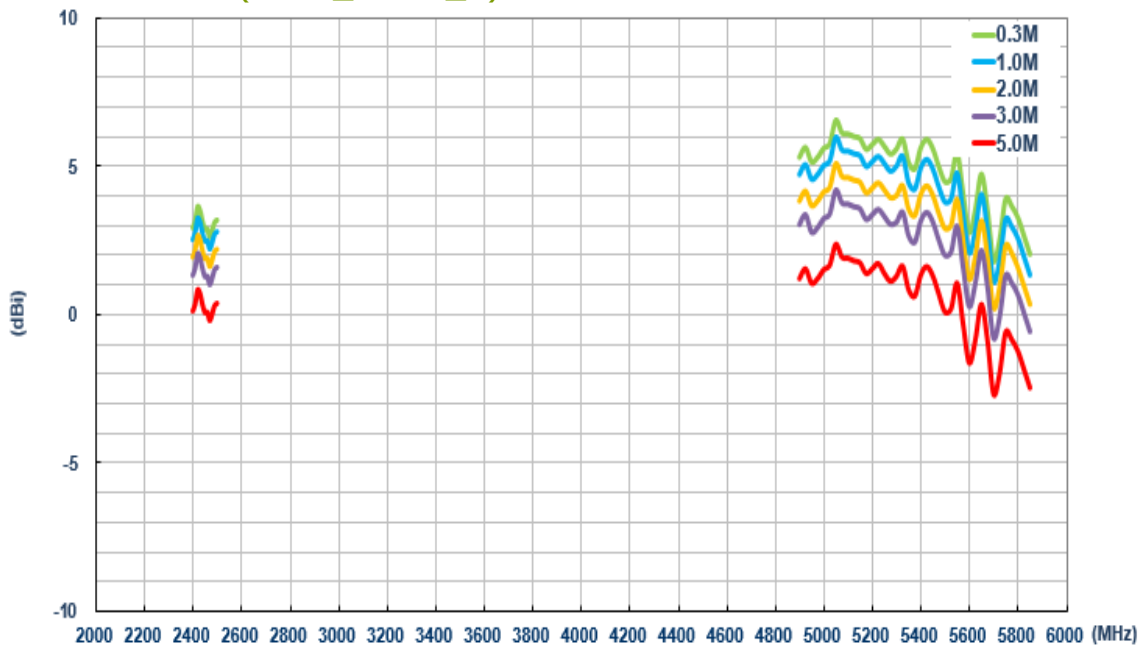

Taoglas makes no warranties based on the accuracy or completeness of the contents of this document and reserves the right to make changes to specifications and product descriptions at any time without notice. Taoglas reserves all rights to this document and the information contained herein.

Reproduction, use or disclosure to third parties without express permission is strictly prohibited.

Copyright © Taoglas Ltd.