

**SPDT UltraCMOS™ RF Switch
DC - 4000 MHz**

Features

Single 3.0-volt power supply

Low insertion loss: 0.35 dB at 1000 MHz, 0.45 dB at 2000 MHz

High isolation of 43 dB at 1000 MHz, 35 dB at 2000 MHz

Typical 1 dB compression point of +32 dBm

Single-pin CMOS or TTL logic control

Available in a 6-lead DFN package

Product Description

The PE4237 RF Switch is designed to cover a broad range of applications from near DC to 4000 MHz. This reflective switch integrates on-board CMOS control logic driven by a single-pin, low voltage CMOS or TTL control input. Using a nominal +3-volt power supply, a 1 dB compression point of +32 dBm can be achieved. The PE4237 also exhibits outstanding isolation of better than 43 dB at 1000 MHz and is offered in a small 3x3 mm DFN package.

The PE4237 is manufactured on Peregrine's UltraCMOS™ process, a patented variation of silicon-on-insulator (SOI) technology on a sapphire substrate, offering the performance of GaAs with the economy and integration of conventional CMOS.

Figure 1. Functional Diagram

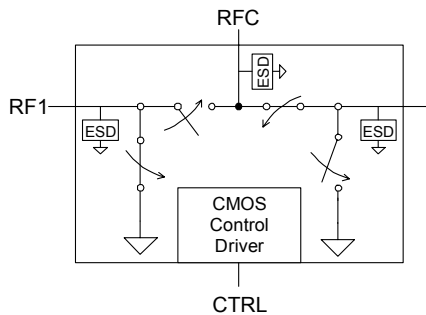

Figure 2. Package Type

6-lead DFN



Table 1. Electrical Specifications @ +25 °C, V_{DD} = 3 V (Z_S = Z_L = 50 Ω)

Parameter	Conditions	Minimum	Typical	Maximum	Units
Operation Frequency ¹		DC		4000	MHz
Insertion Loss	1000 MHz		0.35	0.50	dB
	2000 MHz		0.45	0.60	dB
Isolation – RFC to RF1/RF2	1000 MHz	41	43		dB
	2000 MHz	33	35		dB
Isolation – RF1 to RF2	1000 MHz	33.5	35		dB
	2000 MHz	26.5	28		dB
Return Loss	1000 MHz	19	24		dB
	2000 MHz	10.5	14		dB
'ON' Switching Time	50% CTRL to 0.1 dB final value, 2 GHz		200		ns
'OFF' Switching Time	50% CTRL to 25 dB isolation, 2 GHz		90		ns
Video Feedthrough ²			15		mV _{pp}
Input 1 dB Compression	2000 MHz	30	32		dBm
Input IP3	2000 MHz, 17 dBm	50			dBm

Notes: 1. Device linearity will begin to degrade below 10 MHz.

2. The DC transient at the output of any port of the switch when the control voltage is switched from Low to High or High to Low in a 50 Ω test set-up, measured with 1 ns risetime pulses and 500 MHz bandwidth.

Figure 3. Pin Configuration

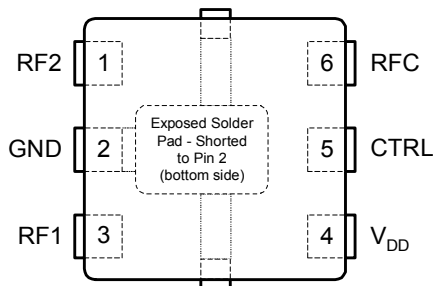

Table 2. Pin Descriptions

Pin No.	Pin Name	Description
1	RF2	RF2 port. ¹
2	GND	Ground Connection. Traces should be physically short and connected to the ground plane. This pin is connected to the exposed solder pad that also must be soldered to the ground plane for best performance.
3	RF1	RF1 port. ¹
4	V _{DD}	Nominal 3 V supply connection.
5	CTRL	CMOS or TTL logic level: High = RFC to RF1 signal path Low = RFC to RF2 signal path
6	RFC	Common RF port for switch. ¹

Notes: 1. All RF pins must be DC blocked with an external series capacitor or held at 0 V_{DC}.

Table 3. Operating Ranges

Parameter	Min	Typ	Max	Units
V _{DD} Power Supply Voltage	2.7	3.0	3.3	V
I _{DD} Power Supply Current (V _{DD} = 3V, V _{CTRL} = 3V)		29	35	μA
T _{OP} Operating temperature range	-40		85	°C
Control Voltage High	0.7xV _{DD}			V
Control Voltage Low			0.3xV _{DD}	V

Moisture Sensitivity Level

The Moisture Sensitivity Level rating for the PE4237 in the 6-lead 3x3 DFN package is MSL1.

Table 4. Absolute Maximum Ratings

Symbol	Parameter/Conditions	Min	Max	Units
V _{DD}	Power supply voltage	-0.3	4.0	V
V _I	Voltage on any input except for the CTRL input	-0.3	V _{DD} +0.3	V
V _{CTRL}	Voltage on CTRL input		5.0	V
T _{ST}	Storage temperature range	-65	150	°C
P _{IN}	Input power (50 Ω)		35	dBm
V _{ESD}	ESD voltage (Human Body Model)		250	V

Exceeding absolute maximum ratings may cause permanent damage. Operation should be restricted to the limits in the Operating Ranges table. Operation between operating range maximum and absolute maximum for extended periods may reduce reliability.

Control Logic Input

The control logic input pin (CTRL) is typically driven by a 3-volt CMOS logic level signal. For flexibility to support systems that have 5-volt control logic drivers, the control logic input has been designed to handle a standard 5-volt TTL control signal. This TTL control signal input must not exceed 5-volts or damage to the switch could result.

Table 5. Control Logic Truth Table

Control Voltage	Signal Path
CTRL = CMOS or TTL High	RFC to RF1
CTRL = CMOS or TTL Low	RFC to RF2

Electrostatic Discharge (ESD) Precautions

When handling this UltraCMOS™ device, observe the same precautions that you would use with other ESD-sensitive devices. Although this device contains circuitry to protect it from damage due to ESD, precautions should be taken to avoid exceeding the rating specified in Table 4.

Latch-Up Avoidance

Unlike conventional CMOS devices, UltraCMOS™ devices are immune to latch-up.

Typical Performance Data @ -40 °C to 85 °C (Unless Otherwise Noted)

Figure 4. Insertion Loss - RFC to RF1

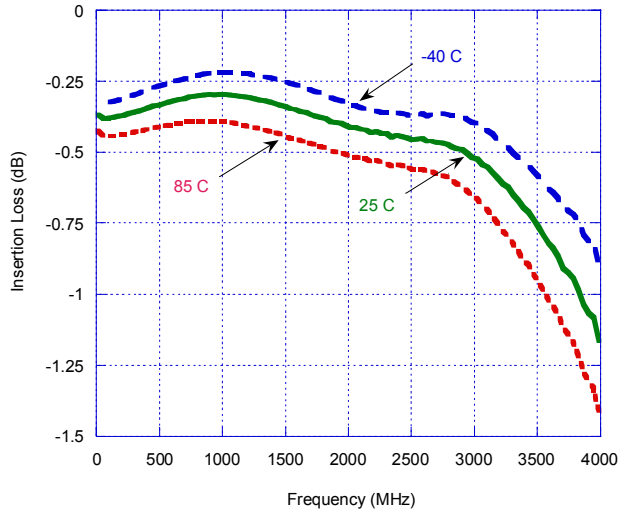

Figure 5. Input 1dB Compression Point

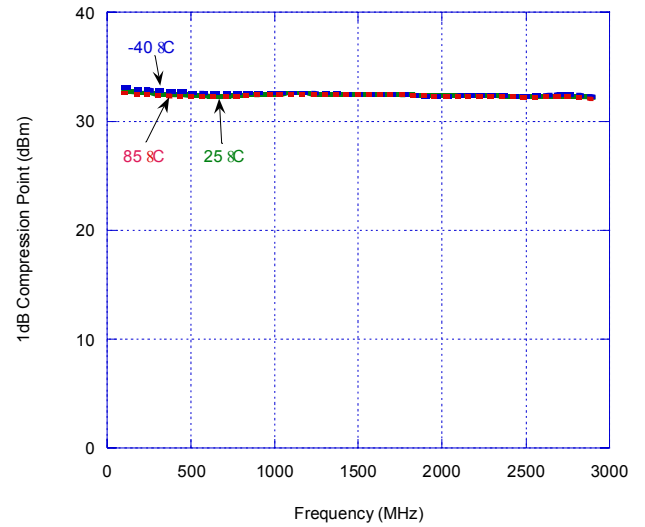

Figure 6. Insertion Loss - RFC to RF2

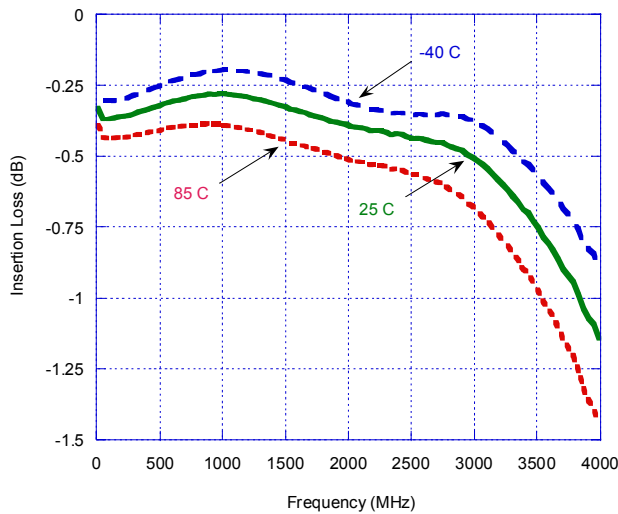
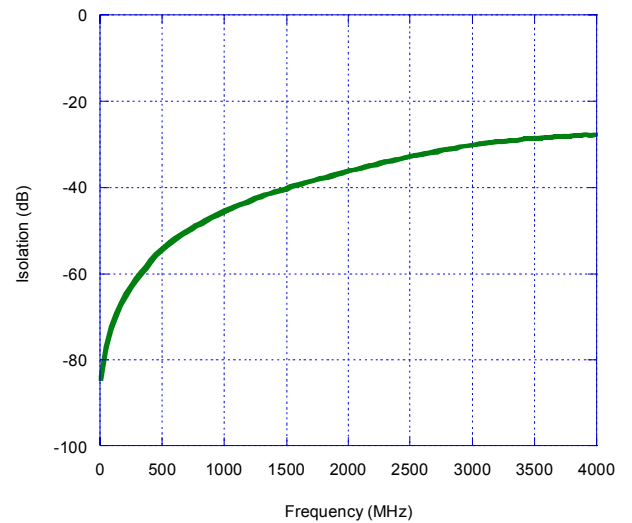

Figure 7. Isolation - RFC to RF1
T = 25 °C



Typical Performance Data @ 25 °C

Figure 8. Isolation – RFC to RF2

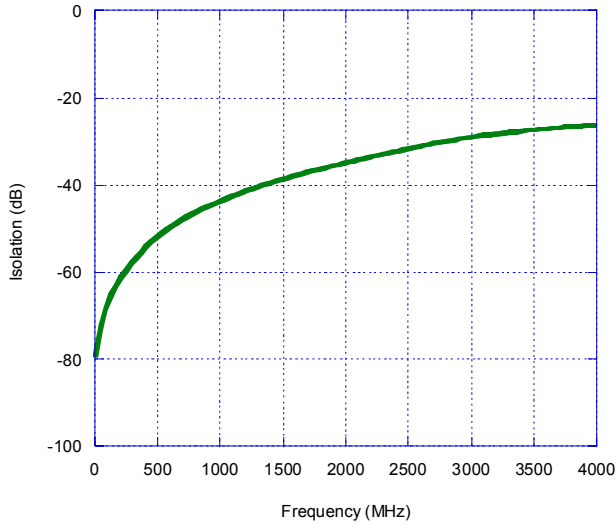

Figure 9. Isolation – RF1 to RF2, RF2 to RF1

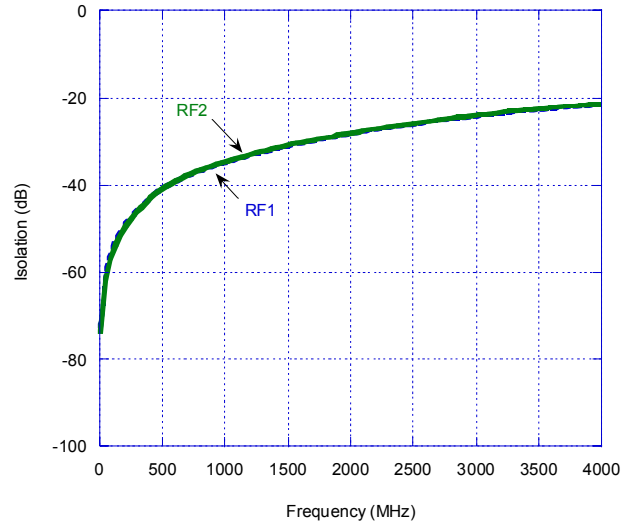

Figure 10. Return Loss – RFC to RF1, RF2

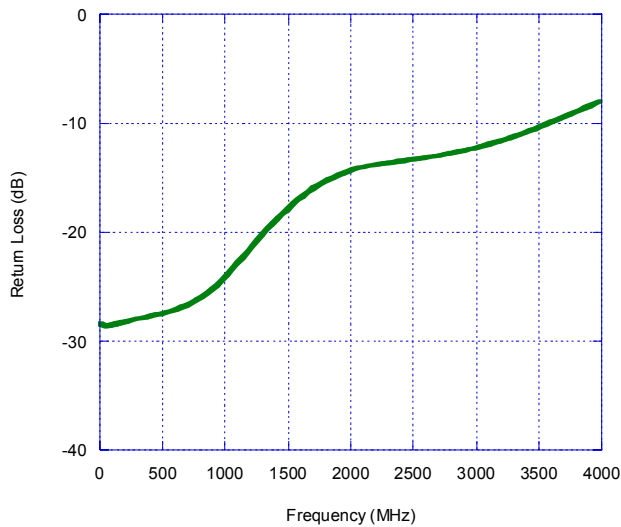
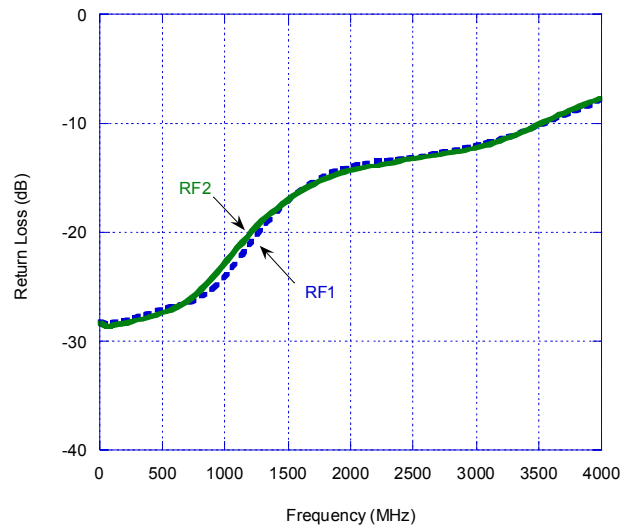

Figure 11. Return Loss – RF1, RF2



Evaluation Kit

The SPDT Switch Evaluation Kit board was designed to ease customer evaluation of the PE4237 SPDT switch. The RF common port is connected through a 50 Ω transmission line to the top left SMA connector, J1. Port 1 and Port 2 are connected through 50 Ω transmission lines to the top two SMA connectors on the right side of the board, J2 and J3. A through transmission line connects SMA connectors J4 and J5. This transmission line can be used to estimate the loss of the PCB over the environmental conditions being evaluated.

The board is constructed of a two metal layer FR4 material with a total thickness of 0.031". The bottom layer provides ground for the RF transmission lines. The transmission lines were designed using a coplanar waveguide with ground plane model using a trace width of 0.0476", trace gaps of 0.030", dielectric thickness of 0.028", metal thickness of 0.0021" and ϵ_r of 4.4.

J6 provides a means for controlling DC and digital inputs to the device. Starting from the lower left pin, the second pin to the right (J6-3) is connected to the device CNTL input. The fourth pin to the right (J6-7) is connected to the device V_{DD} input. A decoupling capacitor (100 pF) is provided on both CTRL and V_{DD} traces. It is the responsibility of the customer to determine proper supply decoupling for their design application. Removing these components from the evaluation board has not been shown to degrade RF performance.

Figure 12. Evaluation Board Layouts
Peregrine Specification 101/0085

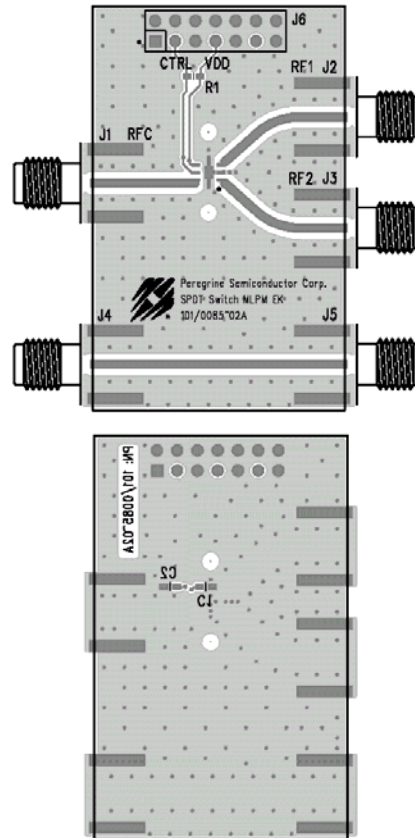

Figure 13. Evaluation Board Schematic
Peregrine Specification 102/0110

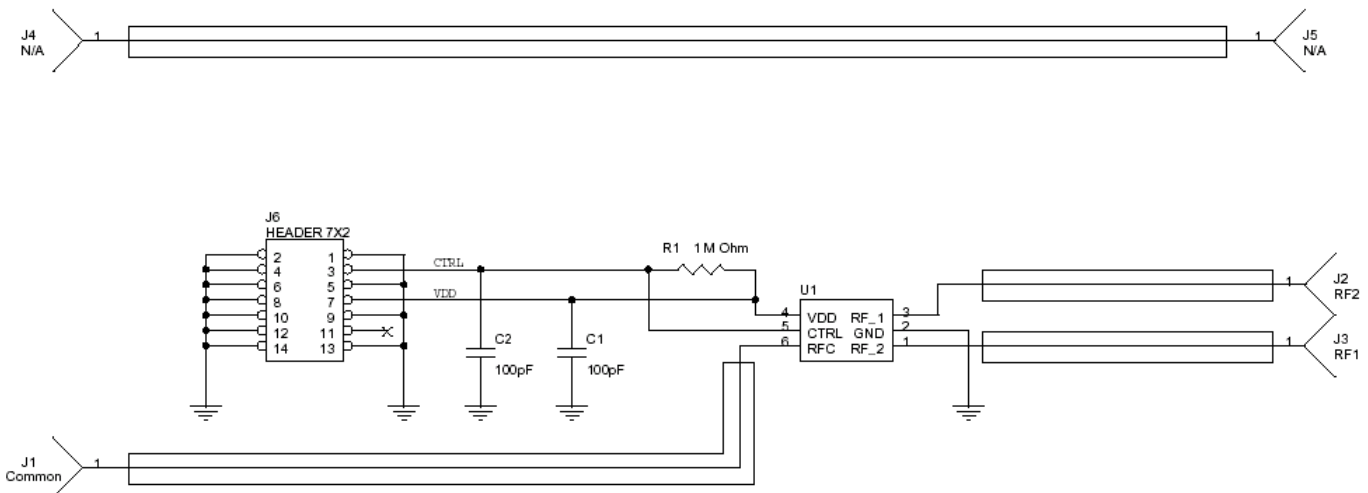
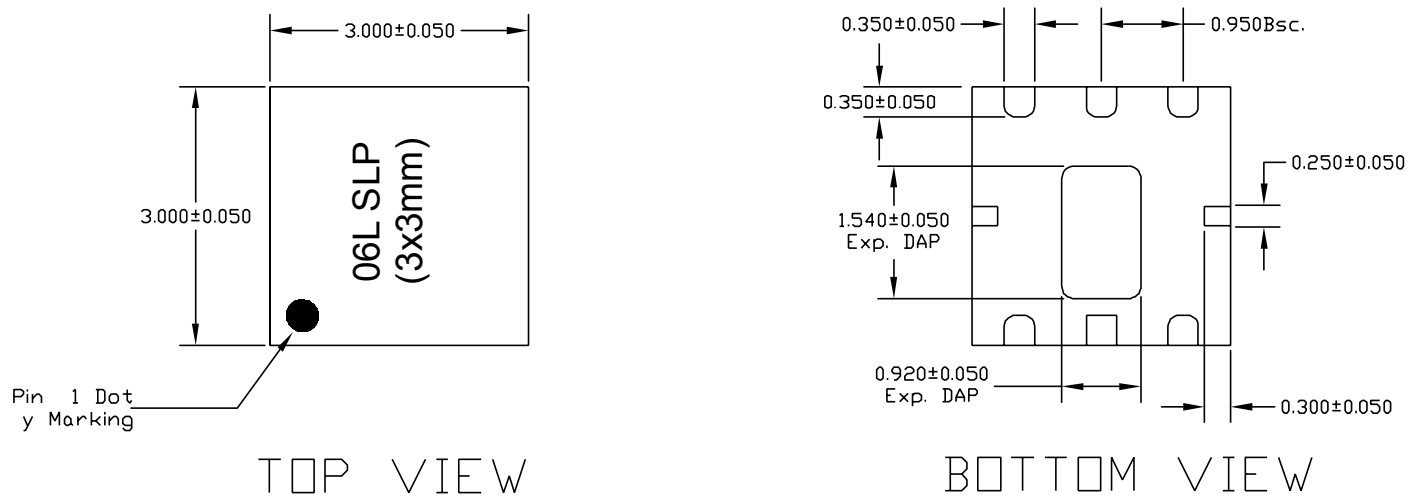

Figure 14. Package Drawing

6-lead DFN



NOTE:

1) TSLP AND SLP SHARE THE SAME EXPOSE OUTLINE BUT WITH DIFFERENT THICKNESS:

		TSLP	SLP
A	MAX.	0.800	0.900
	NOM.	0.750	0.850
	MIN.	0.700	0.800

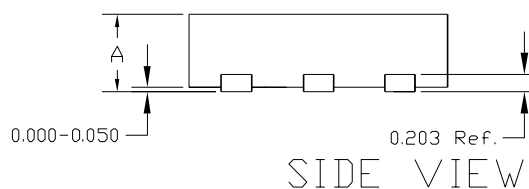

NOTE: The exposed solder pad (on the bottom of the package) is electrically connected to pin 2 (fused.)

Figure 15. Marking Specifications



YYWW = Date Code (last two digits of year and work week)
ZZZZZ = Last five digits of Lot Number

Figure 16. Tape and Reel Specifications

6-lead DFN

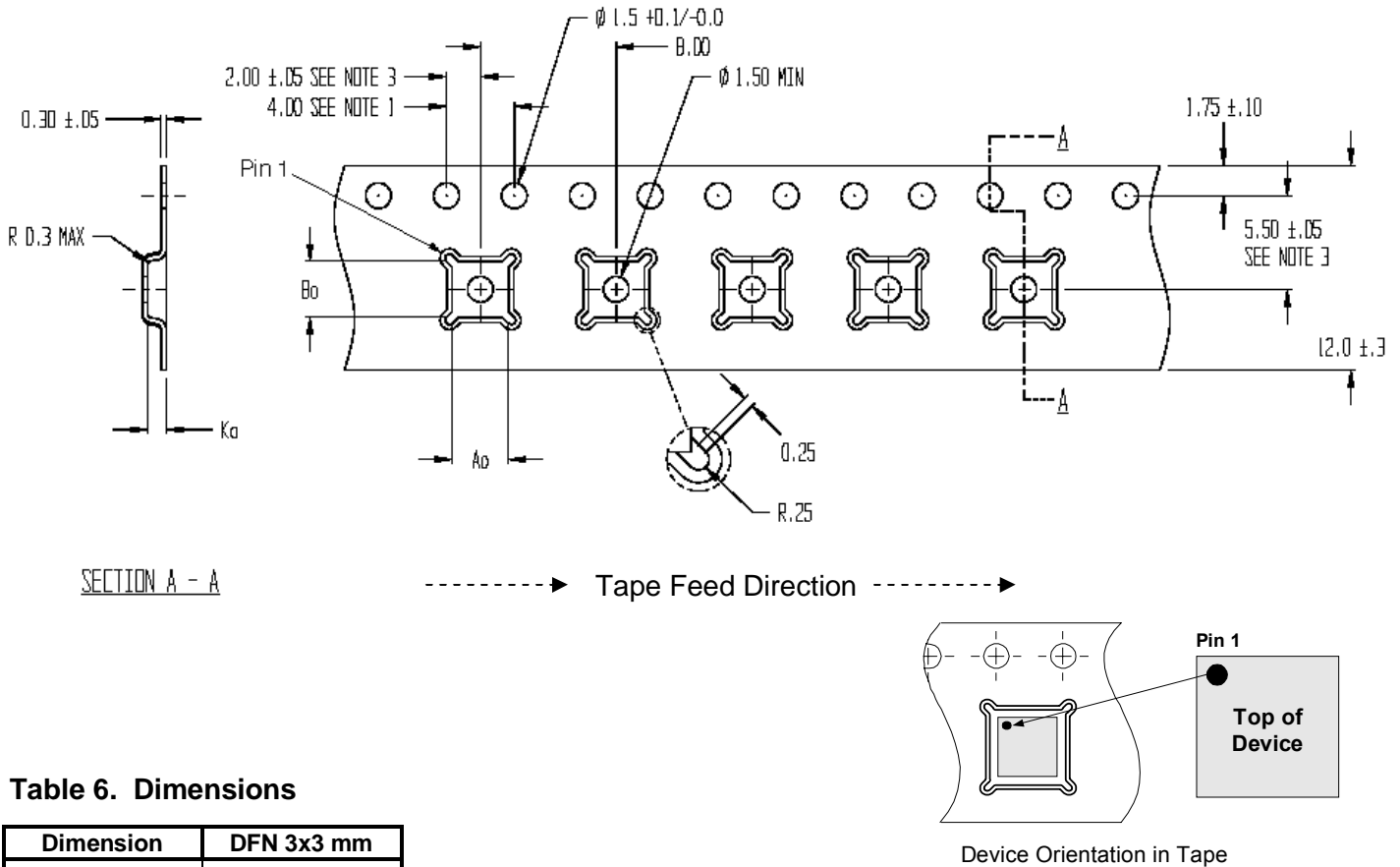

Table 6. Dimensions

Dimension	DFN 3x3 mm
Ao	3.23 ± 0.1
Bo	3.17 ± 0.1
Ko	1.37 ± 0.1
P	4 ± 0.1
W	8 +0.3, -0.1
T	0.254 ± 0.02
R7 Quantity	3000
R13 Quantity	N.A.

Note: R7 = 7 inch Lock Reel, R13 = 13 inch Lock Reel

- NOTES:
1. 10 SPROCKET HOLE PITCH CUMULATIVE TOLERANCE ±0.2
 2. CAMBER IN COMPLIANCE WITH EIA 481
 3. POCKET POSITION RELATIVE TO SPROCKET HOLE MEASURED AS TRUE POSITION OF POCKET, NOT POCKET HOLE

Table 7. Ordering Information

Order Code	Part Marking	Description	Package	Shipping Method
4237-51	4237	PE4237G-06DFN 3x3mm-12800F	Green 6-lead 3x3 mm DFN	Tape or loose
4237-52	4237	PE4237G-06DFN 3x3mm-3000C	Green 6-lead 3x3 mm DFN	3000 units / T&R
4237-00	PE4237-EK	PE4237-06DFN 3x3mm-EK	Evaluation Kit	1 / Box

Sales Offices

The Americas

Peregrine Semiconductor Corporation

9380 Carroll Park Drive
San Diego, CA 92121
Tel: 858-731-9400
Fax: 858-731-9499

Europe

Peregrine Semiconductor Europe

Bâtiment Maine
13-15 rue des Quatre Vents
F-92380 Garches, France
Tel: +33-1-4741-9173
Fax : +33-1-4741-9173

High-Reliability and Defense Products

Americas

San Diego, CA, USA
Phone: 858-731-9475
Fax: 848-731-9499

Europe/Asia-Pacific

Aix-En-Provence Cedex 3, France
Phone: +33-4-4239-3361
Fax: +33-4-4239-7227

For a list of representatives in your area, please refer to our Web site at: www.psemi.com

Data Sheet Identification

Advance Information

The product is in a formative or design stage. The data sheet contains design target specifications for product development. Specifications and features may change in any manner without notice.

Preliminary Specification

The data sheet contains preliminary data. Additional data may be added at a later date. Peregrine reserves the right to change specifications at any time without notice in order to supply the best possible product.

Product Specification

The data sheet contains final data. In the event Peregrine decides to change the specifications, Peregrine will notify customers of the intended changes by issuing a DCN (Document Change Notice).

Peregrine Semiconductor, Asia Pacific (APAC)

Shanghai, 200040, P.R. China
Tel: +86-21-5836-8276
Fax: +86-21-5836-7652

Peregrine Semiconductor, Korea

#B-2607, Kolon Tripolis, 210
Geumgok-dong, Bundang-gu, Seongnam-si
Gyeonggi-do, 463-943 South Korea
Tel: +82-31-728-3939
Fax: +82-31-728-3940

Peregrine Semiconductor K.K., Japan

Teikoku Hotel Tower 10B-6
1-1-1 Uchisaiwai-cho, Chiyoda-ku
Tokyo 100-0011 Japan
Tel: +81-3-3502-5211
Fax: +81-3-3502-5213

The information in this data sheet is believed to be reliable. However, Peregrine assumes no liability for the use of this information. Use shall be entirely at the user's own risk.

No patent rights or licenses to any circuits described in this data sheet are implied or granted to any third party.

Peregrine's products are not designed or intended for use in devices or systems intended for surgical implant, or in other applications intended to support or sustain life, or in any application in which the failure of the Peregrine product could create a situation in which personal injury or death might occur. Peregrine assumes no liability for damages, including consequential or incidental damages, arising out of the use of its products in such applications.

The Peregrine name, logo, and UTSi are registered trademarks and UltraCMOS, HaRP, MultiSwitch and DuNE are trademarks of Peregrine Semiconductor Corp.