

3 V, SUPER MINIMOLD 1900 MHz SI RFIC AMPLIFIER

FEATURES

- **HIGH DENSITY SURFACE MOUNTING:**
6 pin super minimold or SOT-363 package
- **GAIN:** 16 dB TYP
- **NOISE FIGURE:** 4.0 dB TYP
- **SUPPLY VOLTAGE:** $V_{CC} = 2.7$ to 3.3 V

DESCRIPTION

The UPC2749TB is a Silicon RF Integrated Circuit which is manufactured using the NESAT III process. This device is suitable as a buffer amplifier for GPS, PCS and other communication receivers. The UPC2749TB is pin compatible and has comparable performance as the larger UPC2749T, so it is suitable for use as a replacement to help reduce system size. The IC is housed in a 6 pin super minimold or SOT-363 package.

The stringent quality assurance and test procedures assure the highest reliability and performance.

**GAIN vs. FREQUENCY
AND TEMPERATURE**

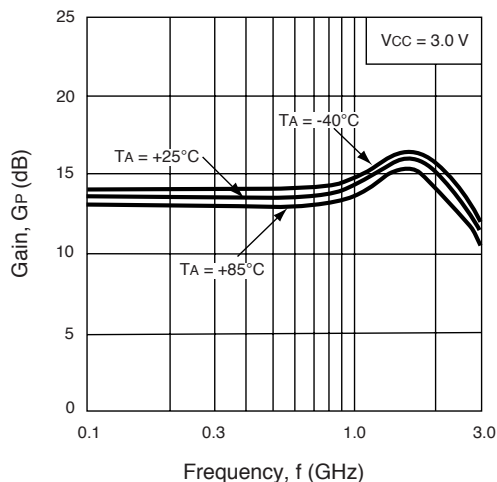

ELECTRICAL CHARACTERISTICS ($T_A = 25^\circ\text{C}$, $Z_L = Z_S = 50 \Omega$, $V_{CC} = 3.0$ V)

PART NUMBER PACKAGE OUTLINE			UPC2749TB SO6		
SYMBOLS	PARAMETERS AND CONDITIONS	UNITS	MIN	TYP	MAX
I_{CC}	Circuit Current (no signal)	mA	4	6	8
G_S	Small Signal Gain, $f = 900$ MHz $f = 1900$ MHz	dB dB	13	14.5 16	18.5
f_{U1}	Upper Limit Operating Frequency	GHz	2.5	2.9	
P_{1dB}	1 dB Compressed Output Power at 1900 MHz	dBm		-12.5	
P_{SAT}	Saturated Output Power, $f = 1900$ MHz	dBm	-9	-6	
NF	Noise Figure, $f = 900$ MHz $f = 1900$ MHz	dB dB		3.2 4.0	5.5
RL_{IN}	Input Return Loss, $f = 1900$ MHz	dB	7	10	
RL_{OUT}	Output Return Loss, $f = 1900$ MHz	dB	9.5	12.5	
ISOL	Isolation, $f = 1900$ MHz	dB	25	30	
OIP_3	SSB Output Third Order Intercept, $f_1 = 1900$ MHz, $f_2 = 1902$ MHz	dBm		-3.5	
$R_{TH} (J-A)$	Thermal Resistance (Junction to Ambient) Mounted on a 50 x 50 x 1.6 mm epoxy glass PWB	$^\circ\text{C}/\text{W}$			325

Note:

1. The gain at f_U is 3 dB down from the gain at 1900 MHz.

ABSOLUTE MAXIMUM RATINGS¹ (T_A = 25°C)

SYMBOLS	PARAMETERS	UNITS	RATINGS
V _{CC}	Supply Voltage	V	4.0
I _{CC}	Total Supply Current	mA	15
P _{IN}	Input Power	dBm	0
P _T	Total Power Dissipation ²	mW	200
T _{OP}	Operating Temperature	°C	-40 to +85
T _{STG}	Storage Temperature	°C	-55 to +150

Notes:

1. Operation in excess of any one of these parameters may result in permanent damage.
2. Mounted on a 50 x 50 x 1.6 mm epoxy glass PWB (T_A = 85°C).

RECOMMENDED OPERATING CONDITIONS

SYMBOLS	PARAMETERS	UNITS	MIN	TYP	MAX
V _{CC}	Supply Voltage	V	2.7	3	3.3
T _{OP}	Operating Temperature	°C	-40	25	85

TEST CIRCUIT

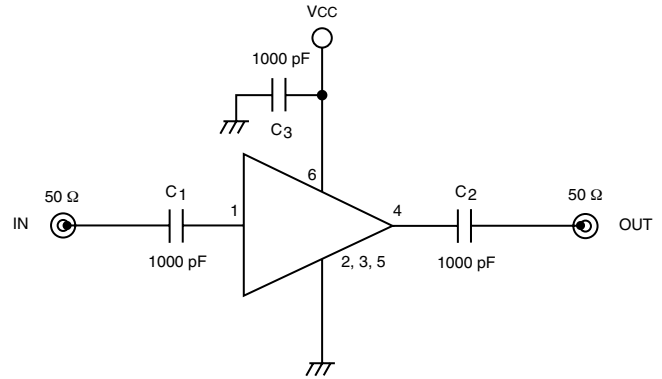

TYPICAL PERFORMANCE CURVES (T_A = 25°C)

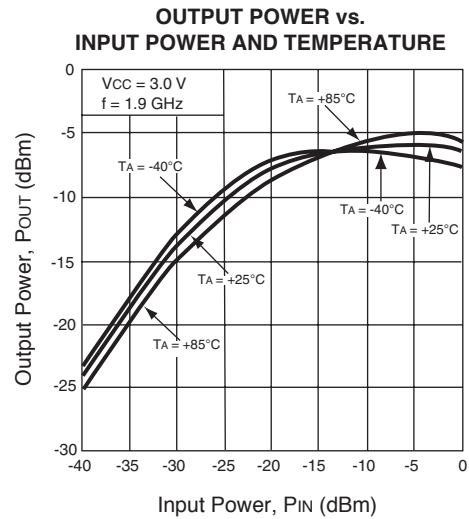
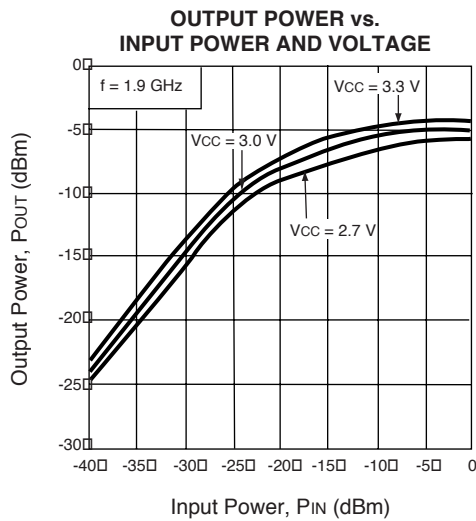
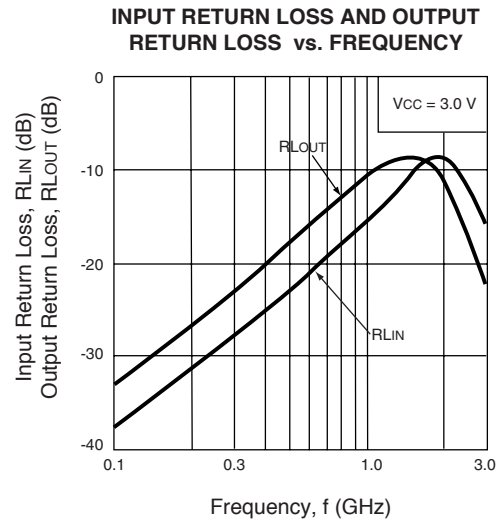
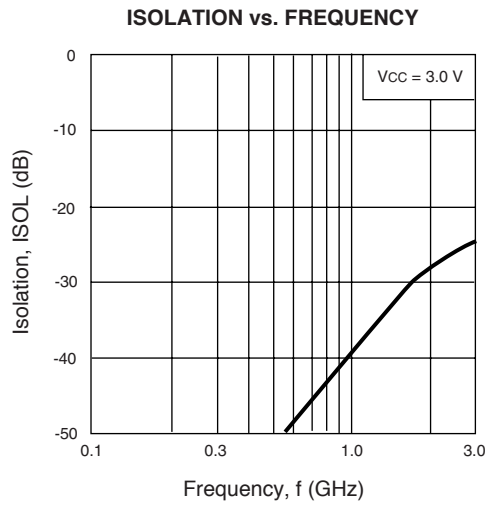

TYPICAL PERFORMANCE CURVES (TA = 25°C)

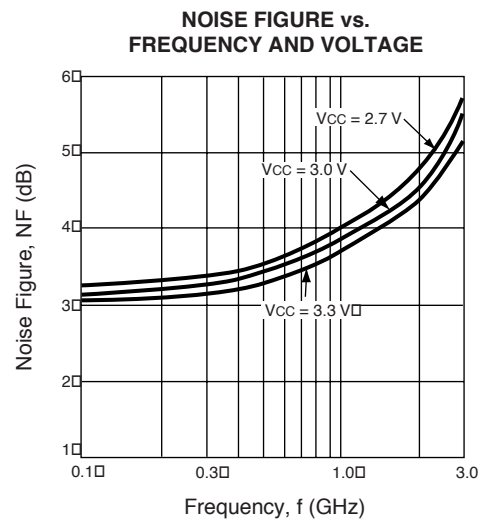
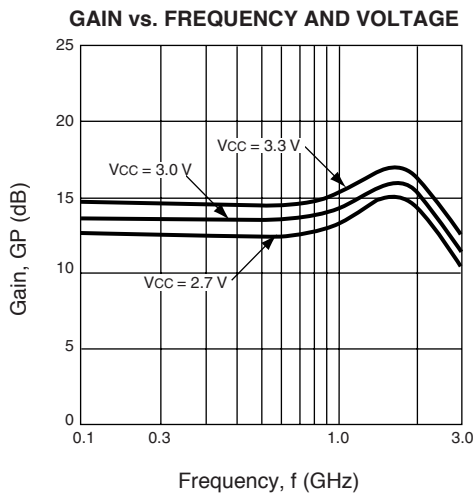
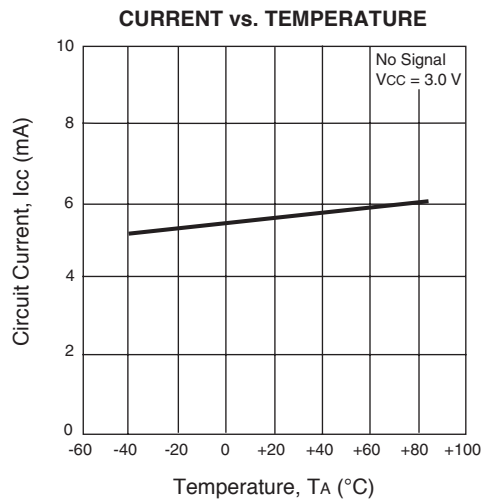
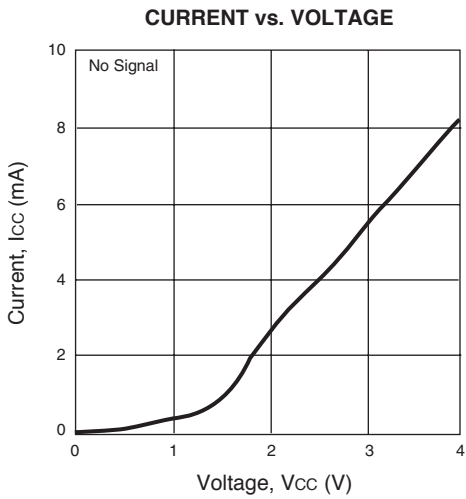
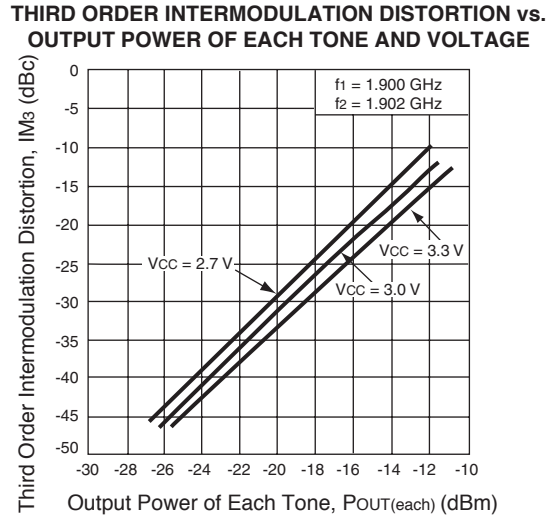
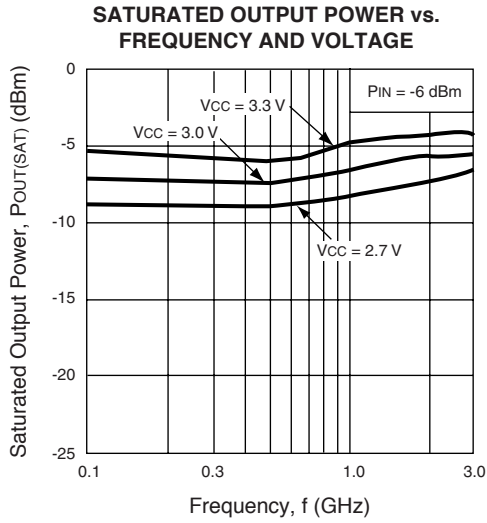

PIN DESCRIPTION

Pin No.	Pin Name	Applied Voltage (V)	Pin Voltage (V)	Description	Internal Equivalent Circuit
1	Input	–	0.82	Signal input pin. An internal matching circuit, configured with resistors, enables 50 Ω connection over a wide bandwidth. A multi-feedback circuit is designed to cancel the deviations of hFE and resistance. This pin must be coupled to the signal source with a blocking capacitor.	
4	Output	–	2.87	Signal output pin. An internal matching circuit, configured with resistors, enables 50 Ω connection over a wide bandwidth. This pin must be coupled to the output load with a blocking capacitor.	
6	Vcc	2.7 to 3.3	–	Power supply pin. This pin should be externally equipped with a bypass capacitor to minimize ground impedance.	
2 3 5	GND	0	–	Ground pins. These pins should be connected to system ground with minimum inductance. Ground pattern on the board should be formed as wide as possible. All the ground pins must be connected together with wide ground pattern to minimize impedance difference.	

SYSTEM APPLICATION EXAMPLE

Example of GPS Receiver

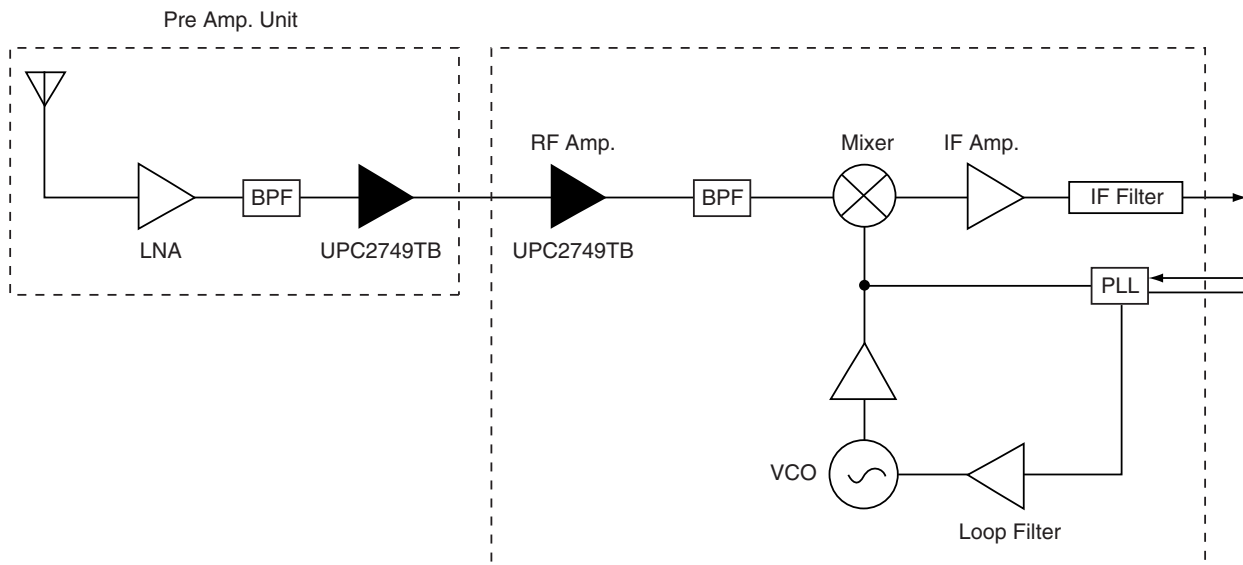

TYPICAL SCATTERING PARAMETERS (T_A = 25°C)

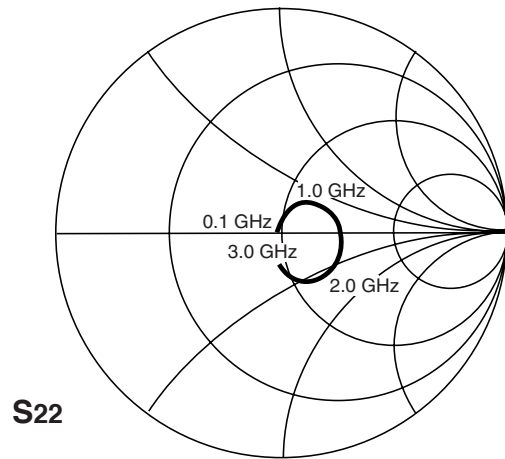
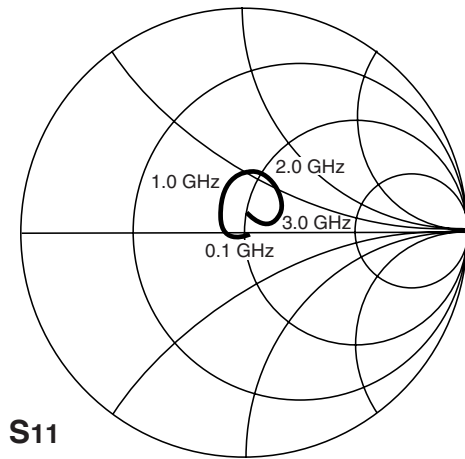

V_{CC} = 3.0 V, I_{CC} = 6.5 mA

FREQUENCY GHz	S ₁₁		S ₂₁		S ₁₂		S ₂₂		K
	MAG	ANG	MAG	ANG	MAG	ANG	MAG	ANG	
0.1	0.021	13.0	4.096	-1.9	0.002	-1.1	0.024	165.8	66.82
0.2	0.038	-30.5	4.216	-7.8	0.001	75.4	0.033	113.6	129.26
0.3	0.034	-71.8	4.282	-15.5	0.001	141.5	0.064	96.1	90.16
0.4	0.052	-120.5	4.403	-21.0	0.002	129.9	0.080	87.9	45.30
0.5	0.062	-149.9	4.390	-26.6	0.002	134.1	0.103	76.9	57.58
0.6	0.079	-169.7	4.399	-31.6	0.003	128.3	0.127	68.6	34.08
0.7	0.097	173.6	4.566	-36.7	0.005	132.9	0.151	60.6	22.08
0.8	0.116	160.5	4.667	-41.3	0.007	131.5	0.174	53.7	14.70
0.9	0.134	149.3	4.843	-46.8	0.008	129.3	0.197	44.9	12.29
1.0	0.156	138.8	5.016	-52.6	0.009	124.6	0.220	36.1	10.00
1.1	0.178	128.5	5.305	-60.3	0.014	131.4	0.240	28.0	6.15
1.2	0.195	118.7	5.660	-67.1	0.016	122.5	0.262	17.3	5.13
1.3	0.214	108.7	5.835	-76.2	0.020	118.6	0.279	8.6	3.80
1.4	0.229	99.5	6.148	-84.5	0.022	114.4	0.287	-2.0	3.23
1.5	0.249	89.4	6.364	-93.8	0.025	107.7	0.294	-13.5	2.72
1.6	0.259	79.9	6.611	-103.6	0.028	104.3	0.294	-23.6	2.35
1.7	0.264	69.8	6.577	-113.5	0.032	96.8	0.283	-33.8	2.09
1.8	0.259	60.3	6.549	-123.4	0.034	91.8	0.272	-44.1	1.99
1.9	0.248	50.9	6.407	-132.9	0.036	83.3	0.036	-53.8	1.97
2.0	0.238	43.6	6.321	-140.8	0.037	78.5	0.234	-61.4	1.99
2.1	0.218	35.9	6.046	-148.8	0.038	75.1	0.213	-69.5	2.04
2.2	0.204	30.1	5.862	-156.5	0.039	70.4	0.193	-73.8	2.08
2.3	0.183	25.3	5.696	-163.2	0.040	68.3	0.174	-79.5	2.15
2.4	0.156	21.2	5.430	-170.5	0.041	60.7	0.164	-84.1	2.25
2.5	0.140	18.8	5.282	-176.3	0.042	61.6	0.152	-82.1	2.25
2.6	0.119	18.7	5.013	177.2	0.040	58.1	0.142	-84.5	2.53
2.7	0.095	21.2	4.849	170.9	0.042	55.1	0.146	-85.5	2.46
2.8	0.078	30.0	4.596	164.9	0.042	51.9	0.149	-83.9	2.62
2.9	0.066	44.5	4.446	158.1	0.042	44.7	0.154	-91.8	2.70
3.0	0.070	66.0	4.163	152.3	0.044	41.9	0.171	-92.8	2.73
3.1	0.082	78.1	3.966	145.3	0.042	37.1	0.181	-99.6	2.97

OUTLINE DIMENSIONS (Units in mm)

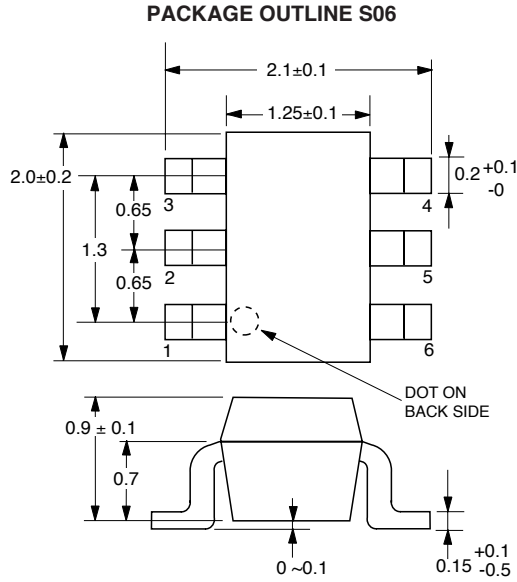

LEAD CONNECTIONS

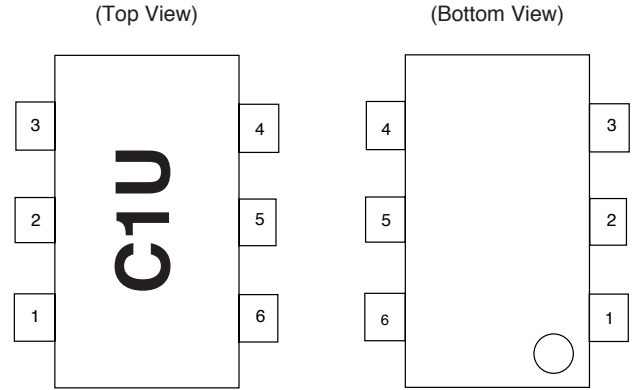

1. INPUT
2. GND
3. GND
4. OUTPUT
5. GND
6. Vcc

ORDERING INFORMATION

PART NUMBER	MARKING	QTY
UPC2749TB-E3-A	CIU	3K/Reel

Note:
Embossed Tape, 8 mm wide. Pins 1, 2 and 3 face perforated side of tape.

EXCLUSIVE NORTH AMERICAN AGENT FOR RF, MICROWAVE & OPTOELECTRONIC SEMICONDUCTORS

CEL CALIFORNIA EASTERN LABORATORIES • Headquarters • 4590 Patrick Henry Drive • Santa Clara, CA 95054-1817 • (408) 988-3500 • Telex 34-6393 • FAX (408) 988-0279
24-Hour Fax-On-Demand: 800-390-3232 (U.S. and Canada only) • Internet: <http://WWW.CEL.COM>

DATA SUBJECT TO CHANGE WITHOUT NOTICE

9/21/2000